



SimpliFiber[®] Pro

Optical Power Meter and Fiber Test Kits

Users Manual

September 2008

©2008 Fluke Corporation. All rights reserved.

All product names are trademarks of their respective companies.

LIMITED WARRANTY AND LIMITATION OF LIABILITY

Each Fluke Networks product is warranted to be free from defects in material and workmanship under normal use and service. The warranty period for the mainframe is one year and begins on the date of purchase. Parts, accessories, product repairs and services are warranted for 90 days, unless otherwise stated. Ni-Cad, Ni-MH and Li-Ion batteries, cables or other peripherals are all considered parts or accessories. The warranty extends only to the original buyer or end user customer of a Fluke Networks authorized reseller, and does not apply to any product which, in Fluke Networks' opinion, has been misused, abused, altered, neglected, contaminated, or damaged by accident or abnormal conditions of operation or handling. Fluke Networks warrants that software will operate substantially in accordance with its functional specifications for 90 days and that it has been properly recorded on non-defective media. Fluke Networks does not warrant that software will be error free or operate without interruption.

Fluke Networks authorized resellers shall extend this warranty on new and unused products to end-user customers only but have no authority to extend a greater or different warranty on behalf of Fluke Networks. Warranty support is available only if product is purchased through a Fluke Networks authorized sales outlet or Buyer has paid the applicable international price. Fluke Networks reserves the right to invoice Buyer for importation costs of repair/replacement parts when product purchased in one country is submitted for repair in another country.

Fluke Networks warranty obligation is limited, at Fluke Networks option, to refund of the purchase price, free of charge repair, or replacement of a defective product which is returned to a Fluke Networks authorized service center within the warranty period.

To obtain warranty service, contact your nearest Fluke Networks authorized service center to obtain return authorization information, then send the product to that service center, with a description of the difficulty, postage and insurance prepaid (FOB destination). Fluke Networks assumes no risk for damage in transit. Following warranty repair, the product will be returned to Buyer, transportation prepaid (FOB destination). If Fluke Networks determines that failure was caused by neglect, misuse, contamination, alteration, accident or abnormal condition of operation or handling, or normal wear and tear of mechanical components, Fluke Networks will provide an estimate of repair costs and obtain authorization before commencing the work. Following repair, the product will be returned to the Buyer transportation prepaid and the Buyer will be billed for the repair and return transportation charges (FOB Shipping point).

THIS WARRANTY IS BUYER'S SOLE AND EXCLUSIVE REMEDY AND IS IN LIEU OF ALL OTHER WARRANTIES, EXPRESS OR IMPLIED, INCLUDING BUT NOT LIMITED TO ANY IMPLIED WARRANTY OR MERCHANTABILITY OR FITNESS FOR A PARTICULAR PURPOSE. FLUKE NETWORKS SHALL NOT BE LIABLE FOR ANY SPECIAL, INDIRECT, INCIDENTAL OR CONSEQUENTIAL DAMAGES OR LOSSES, INCLUDING LOSS OF DATA, ARISING FROM ANY CAUSE OR THEORY.

Since some countries or states do not allow limitation of the term of an implied warranty, or exclusion or limitation of incidental or consequential damages, the limitations and exclusions of this warranty may not apply to every buyer. If any provision of this Warranty is held invalid or unenforceable by a court or other decision-maker of competent jurisdiction, such holding will not affect the validity or enforceability of any other provision.

4/04

Fluke Networks
PO Box 777
Everett, WA 98206-0777
USA

Contents

Title	Page
Introduction	1
Registration	2
The Fluke Networks Knowledge Base	2
Contacting Fluke Networks	2
Safety Information	3
Unpacking	4
SimpliFiber Pro Power Meter	4
FTK1000	4
FTK2000	5
FTK1300	5
FTK1350	6
FTK1450	6
Battery Installation, Life, and Status	7
Meter and Source Features	8
Display Features	10
Setting User Preferences	12
Continuous Wave/2 kHz Modes	14
Auto Wavelength Mode	14
Cleaning Connectors and Adapters	15

SimpliFiber Pro Meter and Test Kits

Users Manual

Cleaning Bulkhead Connectors (sources and patch panels)	15
Cleaning the Meter's Connector	15
Cleaning Fiber Adapters	15
Cleaning Connector Ends	16
Changing the Connector Adapter	16
Detecting Active Fibers	18
Locating Fibers	20
Measuring Optical Power	22
Using the Min/Max Function	25
Measuring Loss	26
About Method B Connections	26
Testing Reference Test Cords	26
About Referencing	27
Setting the Reference	27
Measuring Loss	30
If Loss is Negative	33
Memory Functions	34
Viewing and Deleting Records	34
Uploading Records to a PC	35
Maintenance	36
Cleaning	36
Checking the Meter's Software Version and Calibration Date	36
Options and Accessories	37
Specifications	40
Environmental Specifications	40
Meter Specifications	40
Multimode Source	42
Singlemode Source	44

FindFiber Source Specifications 46

 Certifications, Compliance, and Regulatory Information 47

Appendix A: Using Mandrels 49

Appendix B: Fiber Test Method Names 53

Appendix C: Loss Test Methods 55

 Introduction 55

 Method A/A.2 56

 Method B/A.1 58

 Method C/A.3 60

 Modified Method B/A.1 62

List of Figures

Figure	Page
1. Installing the Batteries.....	7
2. Meter and Source Features	8
3. Display Features	10
4. Installing the Connector Adapter	17
5. Detecting Active Fibers.....	19
6. Using FindFiber Mode to Locate Fibers	21
7. Power Measurement Connections	23
8. Power Measurement Display.....	24
9. Power Measurement Display with Min/Max Function Enabled	25
10. Reference Connections (Method B)	28
11. Loss Measurement Connections (Method B).....	31
12. Loss Measurement Display	32
13. View Record Display	34
14. Connecting to a PC	35
A-1. Wrapping a Reference Test Cord Around a Mandrel	50
A-2. Mandrel Placement.....	51
C-3. Method A/A.2 Reference and Test Connections	57
C-4. Method B/A.1 Reference and Test Connections.....	59
C-5. Method C/A.3 Reference and Test Connections.....	61

Figure

Page

C-6. Modified Method B/A.1 Reference and Test Connections..... 63

SimpliFiber® Pro Fiber Test Kits

Introduction

The SimpliFiber® Pro Fiber Test kits provide an optical power meter, optical power source, and fiber locator that let you do the following:

- Measure optical power or power loss at multiple wavelengths in one test. The meter measures at 850 nm, 1300 nm, 1310 nm, 1490 nm, 1550 nm, and 1625 nm. Source wavelengths depend on the model used.
- Check fibers for optical activity with CheckActive™ mode.
- Identify links at patch panels with FindFiber™ mode.
- Optional visual fault locator and fiber microscopes let you locate cable faults and inspect fiber endfaces for contamination or damage.
- Save up to 1000 test records. You can use LinkWare™ software to upload the records to a PC and create professional-quality test reports.

Registration

Registering your product with Fluke Networks gives you access to valuable information on product updates, troubleshooting tips, and other support services. To register, fill out the online registration form on the Fluke Networks website at www.flukenetworks.com/registration.

The Fluke Networks Knowledge Base

The Fluke Networks Knowledge Base answers common questions about Fluke Networks products and provides articles on cable testing techniques and technology. To access the Knowledge Base, log on to www.flukenetworks.com, then click **Knowledge Base** at the top of the page.

Contacting Fluke Networks



www.flukenetworks.com



support@flukenetworks.com



+1-425-446-4519





- Australia: 61 (2) 8850-3333 or 61 (3) 9329 0244
- Beijing: 86 (10) 6512-3435
- Brazil: 11 3759 7600
- Canada: 1-800-363-5853
- Europe: +44-(0)1923 281 300
- Hong Kong: 852 2721-3228
- Japan: 03-3434-0510
- Korea: 82 2 539-6311
- Singapore: +65-6799-5566
- Taiwan: (886) 2-227-83199
- USA: 1-800-283-5853

Visit our website for a complete list of phone numbers.

Safety Information

Table 1 describes the international electrical symbols used on the tester and in this manual.

Table 1. International Electrical Symbols

	<p>Warning or Caution: risk of damage or destruction to equipment or software. See explanations in the manual.</p>
	<p>Warning: Risk of electric shock.</p>
	<p>Warning: Class 1 laser (singlemode and FindFiber sources). Risk of eye damage from hazardous radiation.</p>
	<p>Do not put products containing circuit boards into the garbage. Dispose of circuits boards in accordance with local regulations.</p>

Warning: Class 1 Laser (singlemode and FindFiber sources)

To avoid possible eye damage caused by hazardous radiation:

- **Never look directly into optical connectors. Some sources produce invisible radiation that can permanently damage your eyes.**
- **Never turn on the source unless a fiber is attached to the port.**
- **Do not use magnification to view the optical outputs without proper filtering.**
- **Use of controls, adjustments, or procedures not stated herein might result in hazardous radiation exposure.**

Caution

To avoid damaging fiber connectors, to avoid data loss, and to ensure maximum accuracy of test results:

- Use proper cleaning procedures to clean all fiber connectors before every use. Neglecting this step or using improper procedures can cause unreliable test results and may permanently damage the connectors.
- Cover all connectors with protective caps when not in use.
- Never connect the source to an active network. Doing so can disrupt network operations.

Unpacking

The SimpliFiber Pro Fiber Verification Kits come with the accessories listed below. If something is damaged or missing, contact the place of purchase immediately.

SimpliFiber Pro Power Meter

- SimpliFiber Pro optical power meter
- USB cable for PC communications
- Getting Started Guide
- SimpliFiber Pro Product Manuals CD

FTK1000

- SimpliFiber Pro optical power meter
- SimpliFiber Pro 850/1300 source
- USB cable for PC communications
- Carrying case
- Getting Started Guide
- SimpliFiber Pro Product Manuals CD
- LinkWare Software CD

FTK2000

- SimpliFiber Pro optical power meter
- SimpliFiber Pro 1310/1550 source
- USB cable for PC communications
- Carrying case
- Getting Started Guide
- SimpliFiber Pro Product Manuals CD
- LinkWare Software CD

FTK1300

- SimpliFiber Pro optical power meter
- SimpliFiber Pro 850/1300 source
- VisiFault™ Visual Fault Locator
- FT120 FiberViewer™ Microscope
- FindFiber™ Source
- LC connector adapter
- ST connector adapter
- USB cable for PC communications
- Carrying case
- Getting Started Guide and Instruction Sheets
- SimpliFiber Pro Product Manuals CD
- LinkWare Software CD

FTK1350

- SimpliFiber Pro optical power meter
- SimpliFiber Pro 850/1300 source
- VisiFault™ Visual Fault Locator
- FT500 FiberInspector™ Mini Video Microscope
- FindFiber™ Source
- LC connector adapter
- ST connector adapter
- USB cable for PC communications
- Carrying case
- Getting Started Guide and Instruction Sheets
- SimpliFiber Pro Product Manuals CD
- LinkWare Software CD

FTK1450

- SimpliFiber Pro optical power meter
- SimpliFiber Pro 850/1300 source
- SimpliFiber Pro 1310/1550 source
- VisiFault™ Visual Fault Locator
- FT500 FiberInspector™ Mini Video Microscope
- Two FindFiber™ Sources
- LC connector adapter
- ST connector adapter
- USB cable for PC communications
- NFC-Kit-Box Fiber Optic Cleaning Kit
- Carrying case
- Getting Started Guide and Instruction Sheets
- SimpliFiber Pro Product Manuals CD
- LinkWare Software CD

Battery Installation, Life, and Status

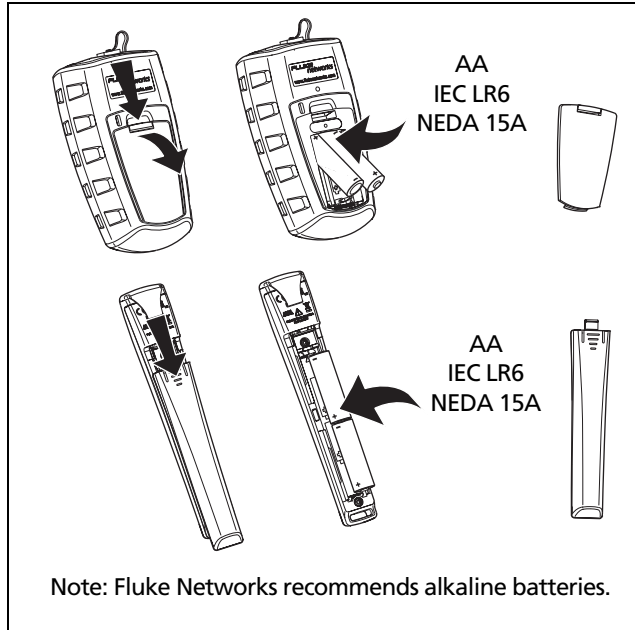

ff103.eps

Figure 1. Installing the Batteries

Table 2. Battery Life and Low Battery Indicators

Device	Battery Life ¹	Low Battery Indicator
Meter	>50 hours	 (blinks continuously)
Multimode source	40 hours	LOW BATTERY LED blinks continuously ²
Singlemode source	30 hours	
FindFiber source	>80 hours	LED blinks continuously

1. Typical. See the specifications.
2. The **LOW BATTERY LED** blinks occasionally if auto power-off is disabled. See page 12.

Meter and Source Features

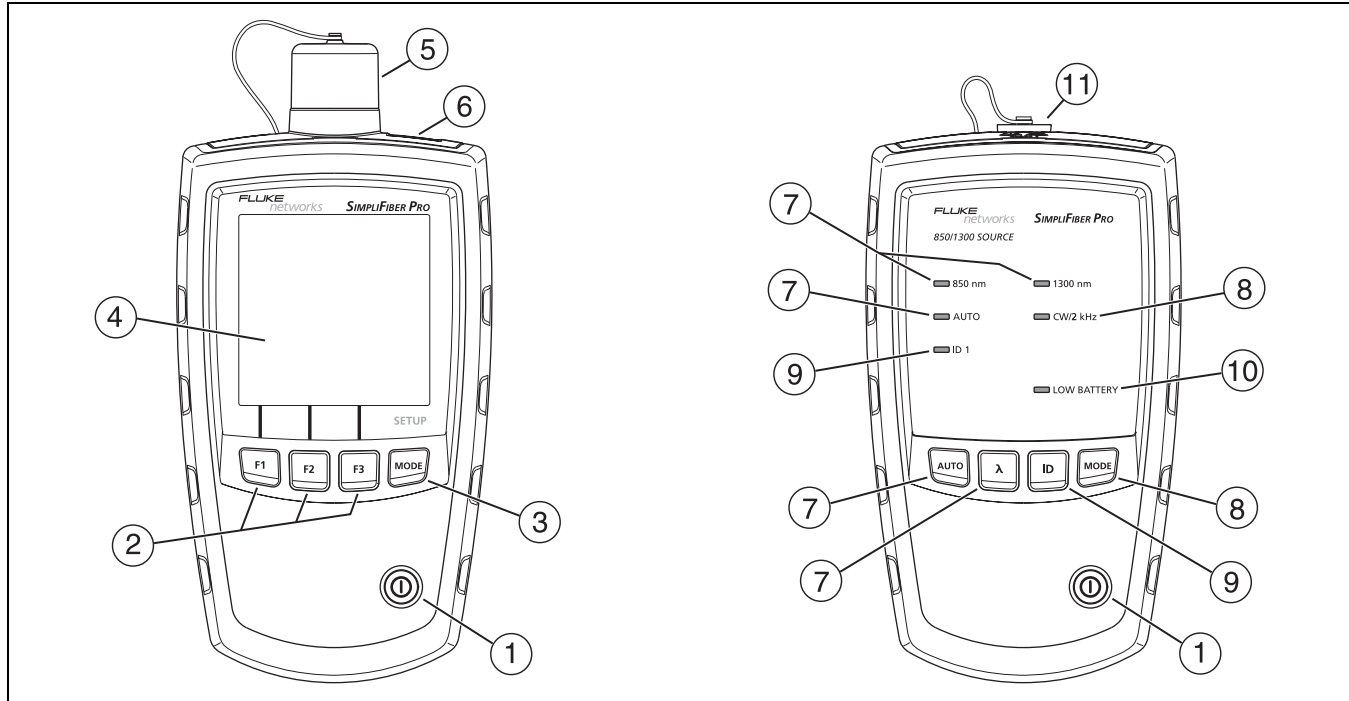

Figure 2. Meter and Source Features

ff104.eps

- ① **I**: On/off key.
- ② **F1** **F2** **F3**: Softkeys, which provide functions related to the current display. The functions are displayed above the keys.
- ③ **MODE**: Selects the meter's measurement mode. To enter setup mode, hold down **MODE** for 4 seconds. See page 12.
- ④ LCD display.
- ⑤ Input port with interchangeable connector adapter. See page 16.
- ⑥ USB port for uploading test records to a PC. See page 35.
- ⑦ **AUTO**: Selects auto wavelength mode. The **AUTO** LED lights. Press **λ** to change the wavelength. The wavelength LEDs indicate the wavelength. See page 14.
- ⑧ **MODE**: Switches between continuous wave and 2 kHz modulated output signals. The **CW/2 kHz** LED lights if the output is continuous. It blinks if the output is modulated. See page 14.
Also enables or disables auto power-off. See page 12.
- ⑨ **ID**: Selects FindFiber mode. The **ID** LED lights if the source is in FindFiber mode. See page 20.
- ⑩ The **LOW BATTERY** LED blinks continuously if the battery is low. The LED blinks occasionally if auto power-off is disabled. See page 12.
- ⑪ Output port with SC adapter.

Display Features

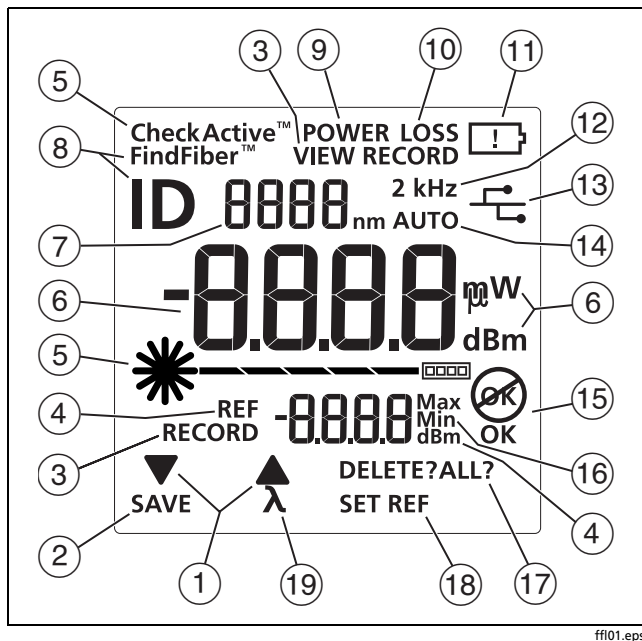









Figure 3. Display Features





ff101.eps

- ① ▼▲: Indicates that pressing **F1** or **F2** scrolls through choices in the current mode.
- ② **SAVE**: Indicates that pressing **F1** saves the power or loss measurement.
- ③ **RECORD**: Label for the record number. **VIEW RECORD**: Indicates the meter is displaying saved measurements. See page 34.
- ④ **REF** (reference): Label for the reference level in loss mode. **dBm**: Measurement unit for the reference level. See page 27.
- ⑤ **★** **CheckActive™**: Indicators for CheckActive mode. **CheckActive™** indicates the meter is testing for fiber activity. See page 18.
- ⑥ Numeric display with units for loss (**dB**) and power measurements (**mW**, **μW**, **dBm**).
- ⑦ Numeric display for the wavelength.
- ⑧ **FindFiber™**: Indicates the meter is testing for a FindFiber source. **ID** is the label for the source's identification number, which appears on the numeric display (⑥). See page 20.
- ⑨ **POWER**: The meter is measuring power. See page 22.
- ⑩ **LOSS**: The meter is measuring power loss. See page 30.

- ⑪ : Low battery indicator. See page 7.
- ⑫ **2 kHz**: The meter detects a 2 kHz modulated optical signal. See page 14.
- ⑬ : The meter is connected to a PC through the USB port. See page 35.
- ⑭ **AUTO**: The meter detects the auto wavelength identifier in the optical signal. See page 14.
- ⑮ **OK** : The operation succeeded (**OK**) or failed .
- ⑯ **Max Min**: Indicators for maximum (**Max**) and minimum (**Min**) power measurements. See page 25.
- ⑰ **DELETE?**: Indicates that pressing  deletes the current record. **DELETE ALL?** indicates that pressing  deletes all records. See page 34.
- ⑱ **SET REF**: Indicates that pressing  saves the power measurement as the reference value. See page 27.
- ⑲ **λ**: Indicates that pressing  changes the wavelength being measured.

Setting User Preferences

For the meter:

- 1 To enter setup mode, hold down  for 4 seconds.
- 2 To scroll through the setup items (Table 3), press . To change settings, press  .
- 3 To exit setup mode, press  until the meter is in the desired test mode.

For the source:

If auto power-off is enabled, the source turns off after 30 minutes if no keys are pressed.

To disable or enable auto power-off, hold down  for 4 seconds.

- If auto power-off is enabled, all LEDs turn on for 3 seconds.
- If auto power-off is disabled, all LEDs blink for 3 seconds and the **LOW BATTERY** LED blinks occasionally.

Table 3. Meter Setup Items

Meter Setup Item	Choices
-0000 ^{Max} -0000	Enable or disable Min Max mode for power measurements.
mW μ W dBm	Select a unit for power measurements: milliwatts (mW), microwatts (μ W), or decibels relative to 1 mW (dBm).
oFF oN	Turn the backlight off or on.
P oFF -- 10 20 30 60	Select a time period for the meter to turn off automatically if no keys are pressed. The meter will not turn off if it is connected to a source that is in AUTO or ID mode. Dashes (- -) indicate auto power-off is disabled.

Continuous Wave/2 kHz Modes



Press  to switch the source between continuous wave and 2 kHz modulated output signals.

- Use continuous wave mode (**CW/2 kHz LED on steady**) if making loss or power measurements with a meter other than a SimpliFiber Pro meter.
- Use the 2 kHz modulated output mode (**CW/2 kHz LED blinking**) if locating fibers with a meter other than a SimpliFiber Pro meter.

Auto Wavelength Mode

In auto wavelength mode the source's signal includes an identifier that tells the meter which wavelength to measure. You can set the source to one wavelength or to automatically switch between wavelengths. When the source is automatically switching, the meter can automatically measure loss or power at each wavelength in one test. If you save the measurements, the meter saves all wavelengths measured in one record.

To set the source to auto wavelength mode:

- 1 If the **AUTO** LED is not on, press .
- 2 Press  to manually switch wavelengths (one wavelength LED is on) or to set the meter to automatically switch between wavelengths (wavelength LEDs blink alternately).

If the meter detects the auto wavelength signal, **AUTO** appears on the display, and the meter automatically measures at the correct wavelength.

Cleaning Connectors and Adapters

Always clean and inspect fiber connectors before making connections. Use fiber optic solvent and optical-grade wipes or swabs to clean connectors as follows:

Cleaning Bulkhead Connectors (sources and patch panels)

- 1 Touch the tip of a fiber optic solvent pen or swab soaked in solvent to a lint-free dry wipe or fiber cleaning card.
- 2 Touch a new, dry swab to the solvent spot on the wipe or card.
- 3 Push the swab into the connector, twist it around 3 to 5 times against the end-face, then remove and dispose of the swab.
- 4 Dry the connector with a dry swab by twisting it around in the connector 3 to 5 times.
- 5 Inspect connectors with a fiber microscope, such as the Fluke Networks FiberInspector™ Video Microscope before making connections.

Cleaning the Meter's Connector

Note

Typically, the meter's connector requires cleaning only if it has been touched.

- 1 Remove the connector adapter to expose the photodiode lens (see Figure 4).
- 2 Use the method described in steps 1 and 2 above to dampen a swab with solvent.
- 3 Twist the damp swab around against the lens 3 to 5 times; then twist a dry swab around against the lens 3 to 5 times.

Cleaning Fiber Adapters

Periodically clean fiber adapters with a swab and fiber optic solvent. Dry with a dry swab before use.

Cleaning Connector Ends

- 1 Touch the tip of a fiber optic solvent pen or swab soaked in solvent to a lint-free dry wipe or fiber cleaning card.
- 2 Wipe the connector end-face across the solvent spot, then back and forth once across the dry area of the wipe or card.

Note

Some connector styles, such as VF-45, may require a different cleaning method.

Always cover unused connectors with protective caps. Clean caps periodically with a swab or wipe and fiber optic solvent.

Changing the Connector Adapter

You can change the meter's connector adapter to connect to SC, ST, and LC fiber connectors. Additional adapter styles may be available. Check the Fluke Networks web site for updates.

Caution

- **Cover all connectors with dust caps when not in use.**
- **Store extra connector adapters in the canisters provided.**
- **Do not touch the photodiode lens (see Figure 4).**
- **Do not overtighten the adapter or use tools to tighten the adapter.**

To install a connector adapter, refer to Figure 4 and do the following:

- 1 Locate the slot in the meter's connector and the key on the adapter ring.
- 2 Holding the adapter so it does not turn in the nut, align the adapter's key with the meter connector's slot and slide the adapter onto the connector.
- 3 Screw the nut onto the meter connector.

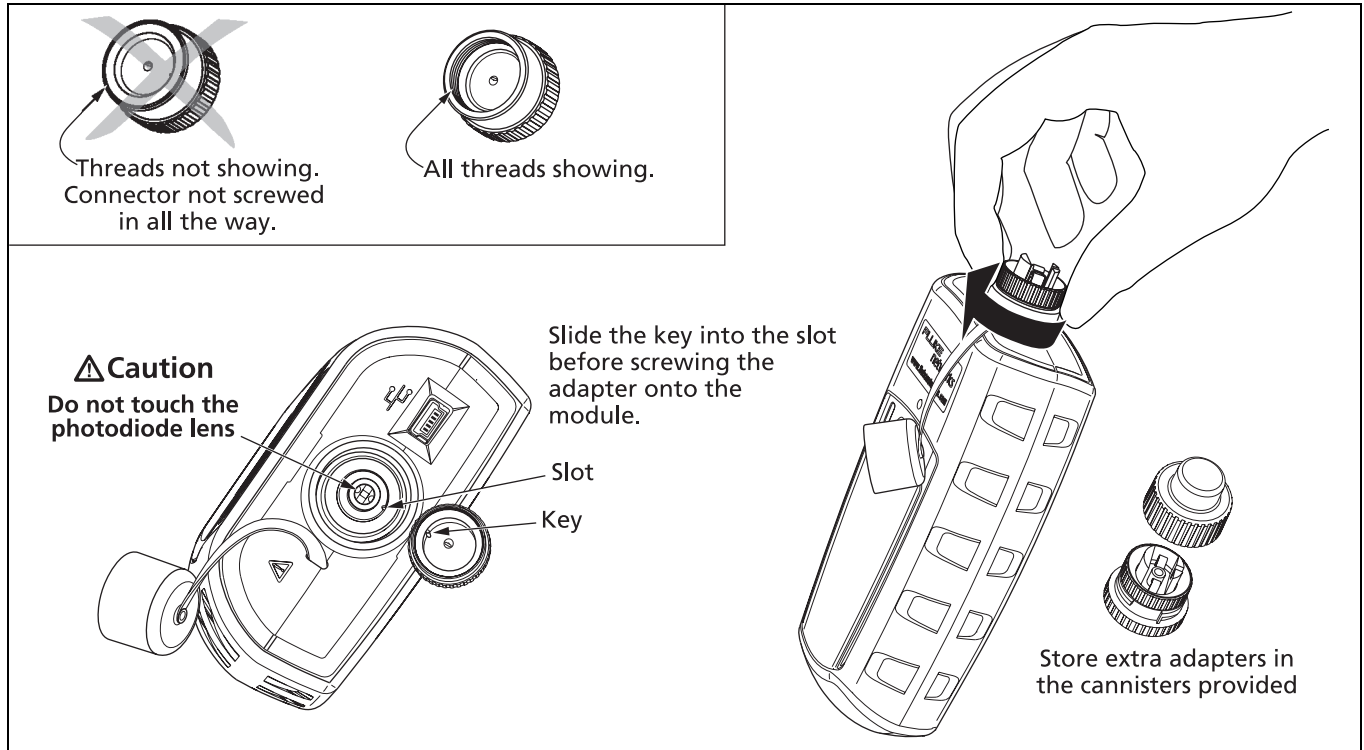



Figure 4. Installing the Connector Adapter

ff105.eps

Detecting Active Fibers

The meter's CheckActive™ mode lets you quickly determine if a fiber is connected to active equipment. This mode helps you locate active links and avoid exposure to hazardous radiation.

To use CheckActive mode:

- 1 Press  until **CheckActive™** appears.
- 2 Connect the meter to a fiber. The meter indicates fiber activity as shown in Figure 5.

Note

Ambient light can activate the CheckActive tone. To avoid this, keep a patch cord connected to the meter if the meter is in CheckActive mode.

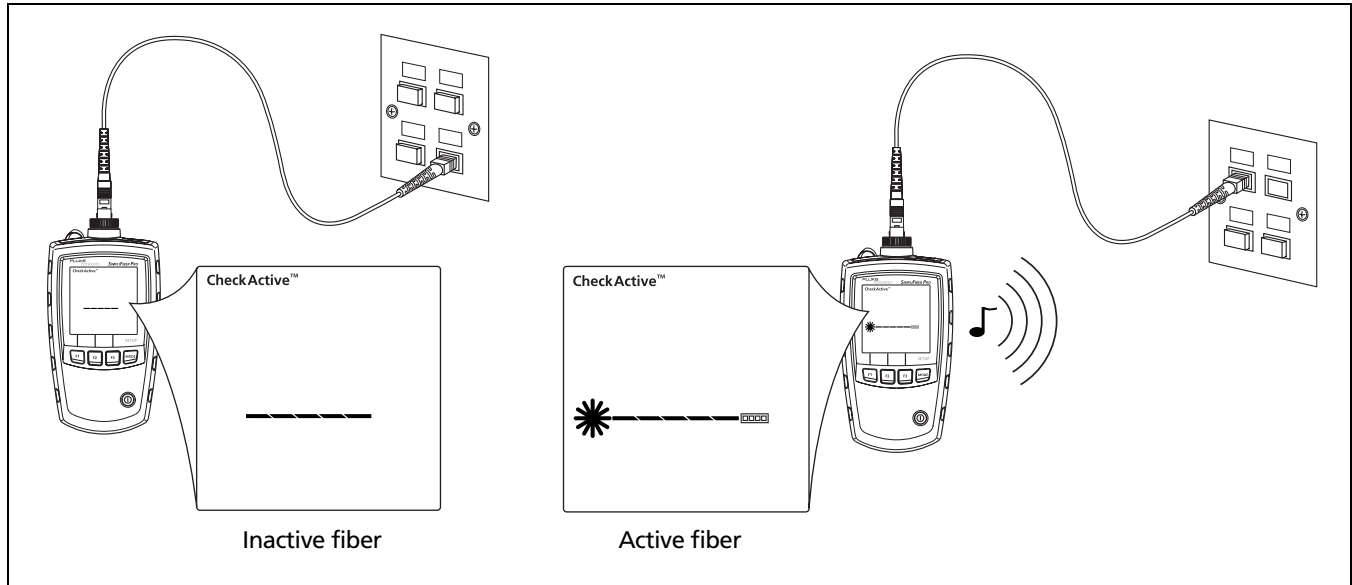

ff123.eps

Figure 5. Detecting Active Fibers

Locating Fibers

FindFiber mode helps you quickly identify link connections at patch panels.

To use FindFiber mode:



- 1 Connect the meter and a SimpliFiber source or one or more FindFiber sources to the links as shown in Figure 6.
- 2 Turn on the meter and the source or FindFiber sources.
 - If you are using a SimpliFiber source, press  on the source.
 - To change the number transmitted by a FindFiber source, turn the source off, hold down the power key for about 4 seconds; then release the key when the desired LED turns on.
- 3 On the meter, press  until **FindFiber™** appears.
- 4 The meter indicates connectivity as shown in Table 4:

Table 4. FindFiber Source Numbers

Source Connected	ID Number on the Meter
SimpliFiber Pro multimode source	
SimpliFiber Pro singlemode source	2
FindFiber source	Number indicated by the source's LED
No continuity or incompatible source connected	----

Note

In power or loss mode, ID blinks if the meter is connected to a FindFiber source or a source in ID mode.

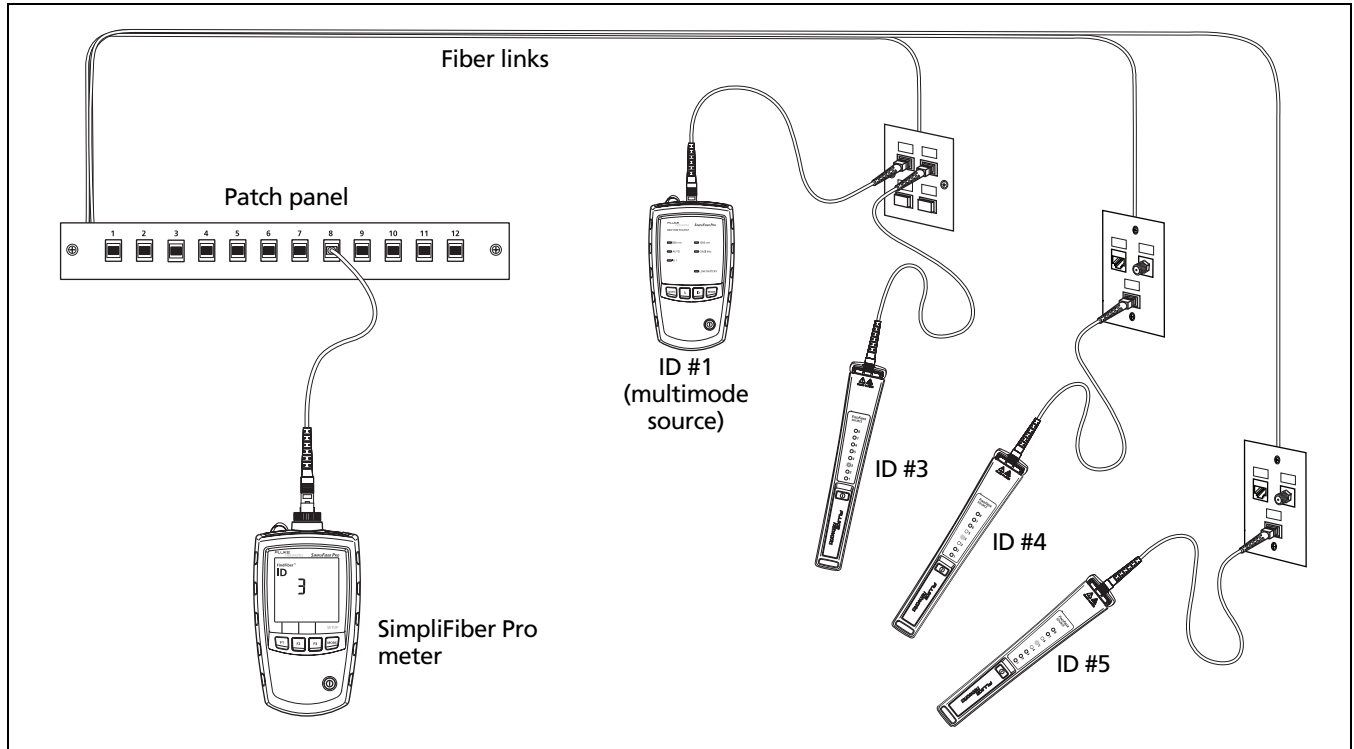





Figure 6. Using FindFiber Mode to Locate Fibers

ff119.eps

Measuring Optical Power

The power measurement shows the optical power level produced by a source such as an optical network interface card or optical test equipment.

To measure power:

- 1 Clean the connectors on the link or source to be tested. Use fiber optic solvent and optical-grade wipes or swabs to clean connectors as described on page 15.
- 2 On the meter, press  until **POWER** appears (Figure 8.)
- 3 Make the connections shown in Figure 7.
- 4 On the meter, press  **λ** to select the wavelength generated by the source.
- 5 To save the measurement, press  **SAVE**. The meter briefly shows the record number and **OK**.

If the source was automatically switching wavelengths, the meter saves measurements for all wavelengths in one record.

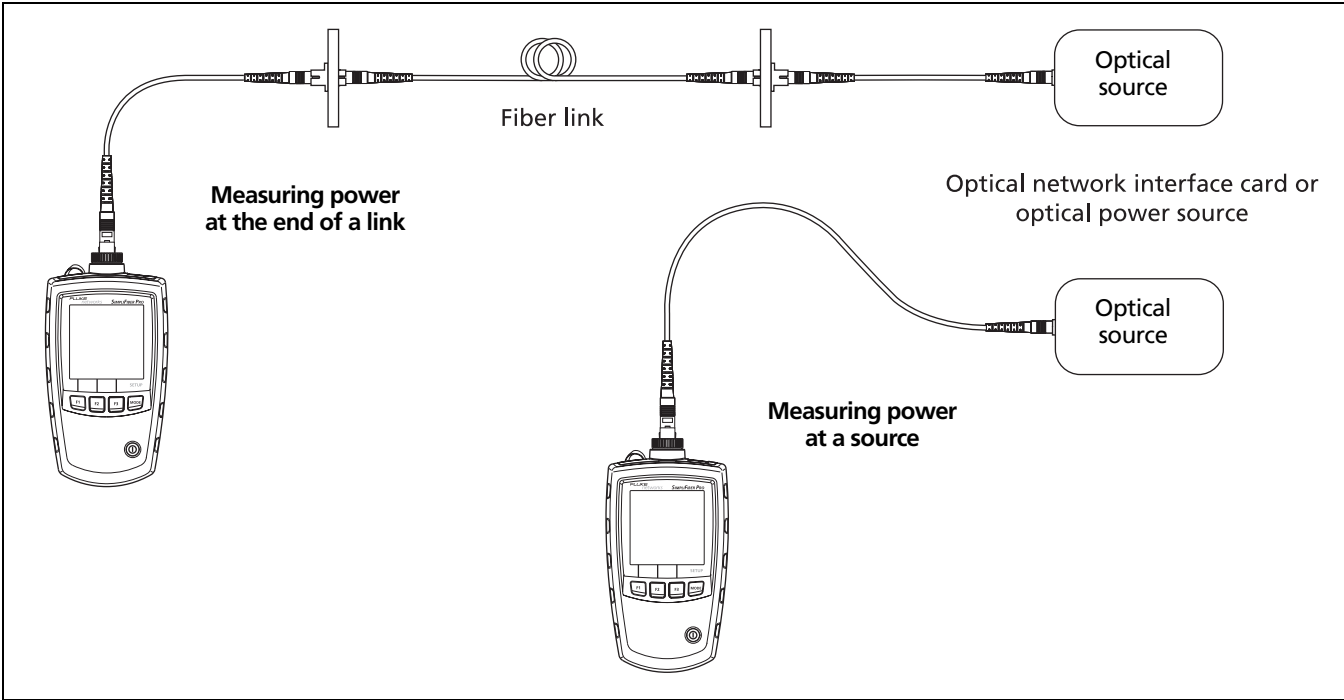

Figure 7. Power Measurement Connections

ffl09.eps

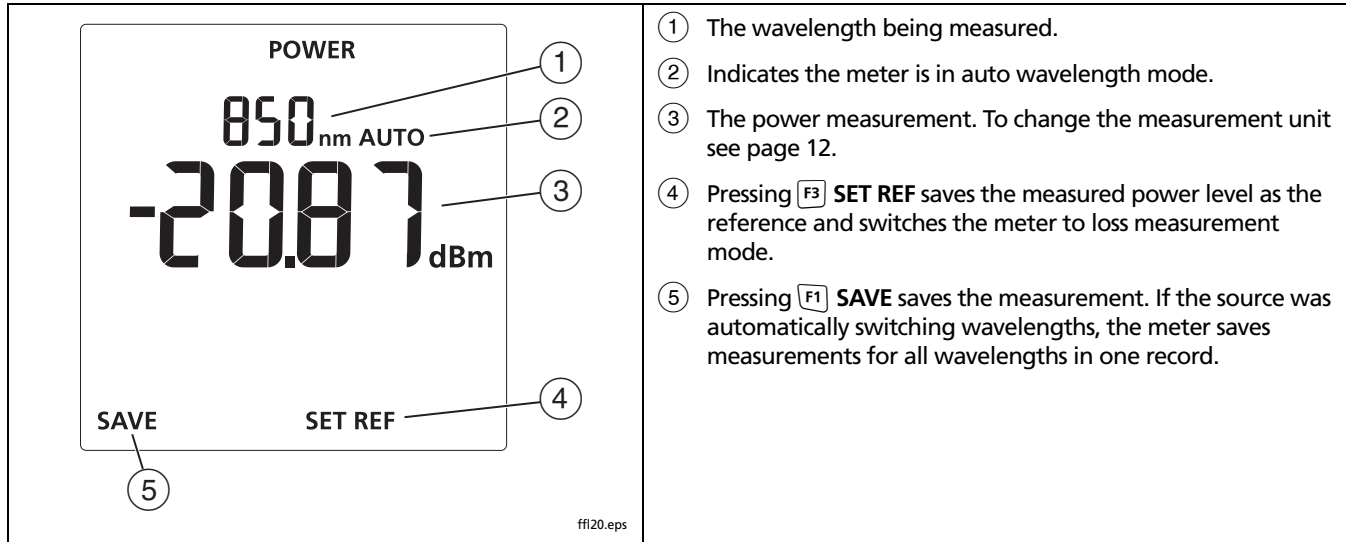





Figure 8. Power Measurement Display

Using the Min/Max Function

The **Min/Max** function shows the minimum and maximum power levels measured for each wavelength.

To enable the **Min/Max** function:

- 1 On the meter, hold down  for 4 seconds to enter setup mode.
- 2 Press  ▼ so that $-8888^{\text{Max}}_{\text{Min}}$ appears.
- 3 Press  until **POWER** appears; then press  again to see the **Min/Max** measurements (Figure 9).

The meter shows the minimum (**Min**) and maximum (**Max**) power levels measured since you entered the power measurement mode at the selected wavelength.

- 4 To switch between minimum and maximum values, press  ▼.

Note

*You cannot save power measurements or set the reference if **Min** or **Max** appear on the display.*

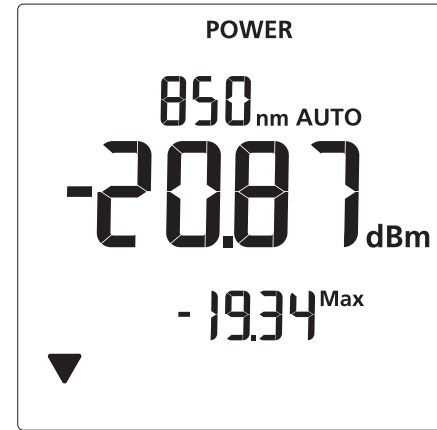

ff14.eps

Figure 9. Power Measurement Display with Min/Max Function Enabled

Measuring Loss

The loss measurement shows how much optical power is lost in a link's fiber and connectors.

About Method B Connections

The reference and test connections shown in this section produce Method B results. Method B results include the loss of the fiber plus the loss of the connections at both ends of the link. This is the most commonly used method for testing installed fiber links. Other methods are shown in Appendix C.

Method B connections require connector adapters that match the connectors in the link under test. If you do not have the correct connector adapters, see Appendix C for alternative connections that produce Method B results.

Testing Reference Test Cords

You should test your reference test cords before each job.

To test a reference test cord:

- 1 Use another set of known-good reference test cords to set a reference as described on page 27.
- 2 Measure loss on the reference test cord as described on page 30. Connect the reference test cord in the place of the fiber link shown in Figure 11.

The loss should be as follows:

- Multimode reference test cord: 0.1 dB or less
 - Singlemode reference test cord: 0.2 dB or less
- 3 Reverse the reference test cord and measure loss in the opposite direction.

About Referencing

The reference serves as the baseline power level for loss measurements. Regular referencing helps account for minor variations in source power and connection integrity. Also, since the reference is the baseline for measurements, the losses of the reference test cords and adapters used for referencing are excluded from test results.

For the most accurate test results, you should set the reference at these times:

- At the beginning of each day.
- Anytime you reconnect a reference test cord to the source.
- Anytime you see a negative loss measurement.

Setting the Reference

You may set the reference from power or loss mode. Fluke Networks recommends using power mode because the meter shows the actual power level produced by the source. In loss mode, the meter shows the difference between the power level and the previous reference level.

To set the reference:

- 1 Clean the connectors on the meter, source, and a reference test cord. Use fiber optic solvent and optical-grade wipes or swabs to clean connectors as described on page 15.
- 2 Turn on the meter and source and let them warm up for 5 minutes. Allow additional time if the equipment has been stored above or below ambient temperature.
- 3 Make the connections shown Figure 10.

-continued-

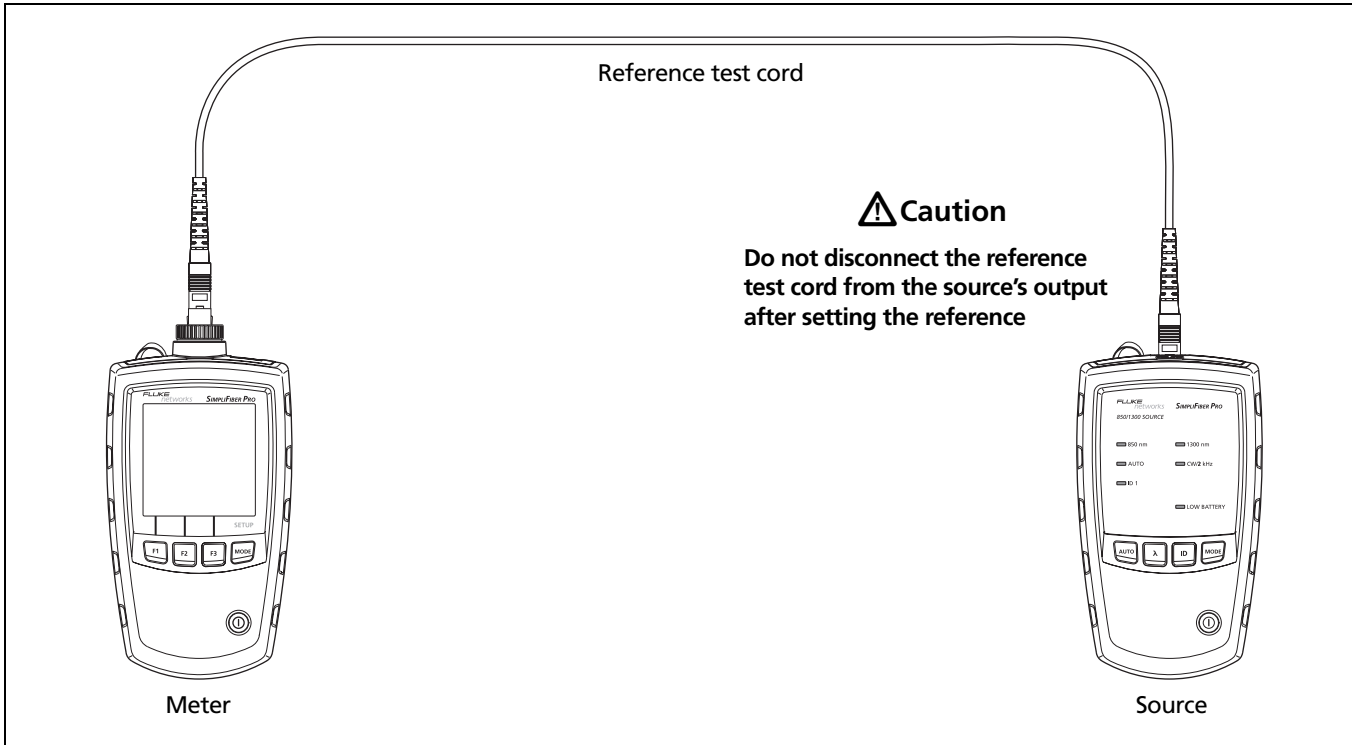

ff107.eps

Figure 10. Reference Connections (Method B)

- 4 If the source's **AUTO** LED is not on, press .

If you want to set the reference for both wavelengths, press  until the wavelength LEDs blink alternately.

Note



If you are not using a SimpliFiber Pro source, set the source to the desired wavelength and continuous wave output.



- 5 On the meter, press  until **POWER** appears (see Figure 8 on page 24).

Notes

*You cannot set the reference if **Min** or **Max** appear on the display. See page 25.*

Setting the reference from power mode lets you see the source's power level before saving it as the reference level. You may also set the reference from loss mode.

- 6 Press  **SET REF**. The meter switches to loss mode, the display shows  dB, **OK** appears briefly, and the new reference value appears.

If the reference value is less than -60 dBm or if the source is in ID or 2 kHz mode, the meter briefly shows  and . Check the connections and the source's mode or try setting the reference again using another reference test cord.

 **Caution**





If you disconnect the source's output after setting the reference, you must set the reference again to ensure valid measurements.

Measuring Loss

- 1 Set the reference as described on page 27.
- 2 Clean the connectors on the link to be tested and on a second reference test cord. Use fiber optic solvent and optical-grade wipes or swabs to clean connectors as described on page 15.
- 3 Disconnect the reference test cord from the meter; then make the connections shown in Figure 11.

Caution

Do not disconnect the reference test cord from the source's output. If you do, you must set the reference again to ensure valid measurements.

- 4 On the meter, press  until **LOSS** appears (Figure 12).
- 5 If the source's **AUTO** LED is not on, press .
- 6 If you want the source to automatically switch wavelengths, press  until the wavelength LEDs blink alternately. Or you may press  to switch wavelengths as needed.

Note

If you are not using a SimpliFiber Pro source, set the source to the desired wavelength and to continuous wave output. On the meter, press  λ to select the wavelength generated by the source.

- 7 To save the measurement, press  **SAVE**. The meter briefly shows the record number and **OK**.

If the source was automatically switching wavelengths, the meter saves measurements for all wavelengths in one record.

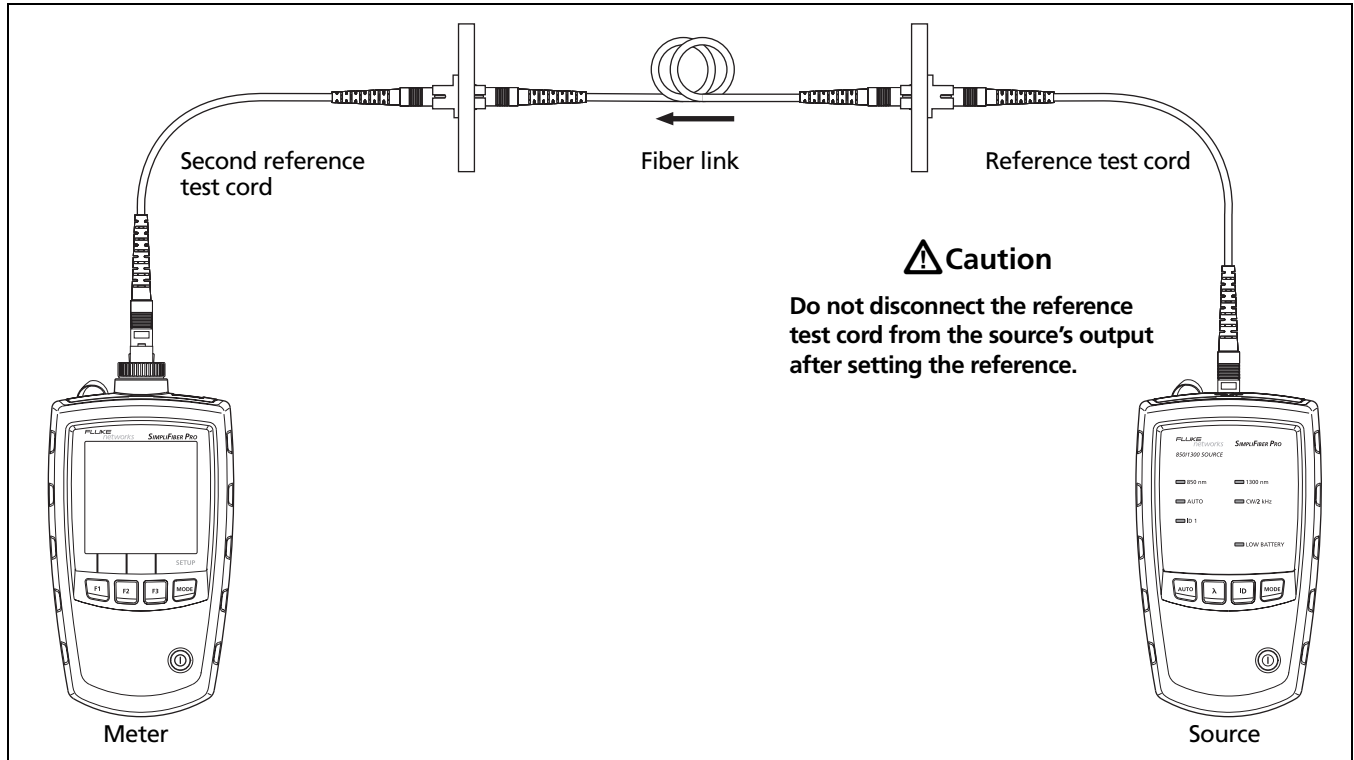

Figure 11. Loss Measurement Connections (Method B)

ff108.eps

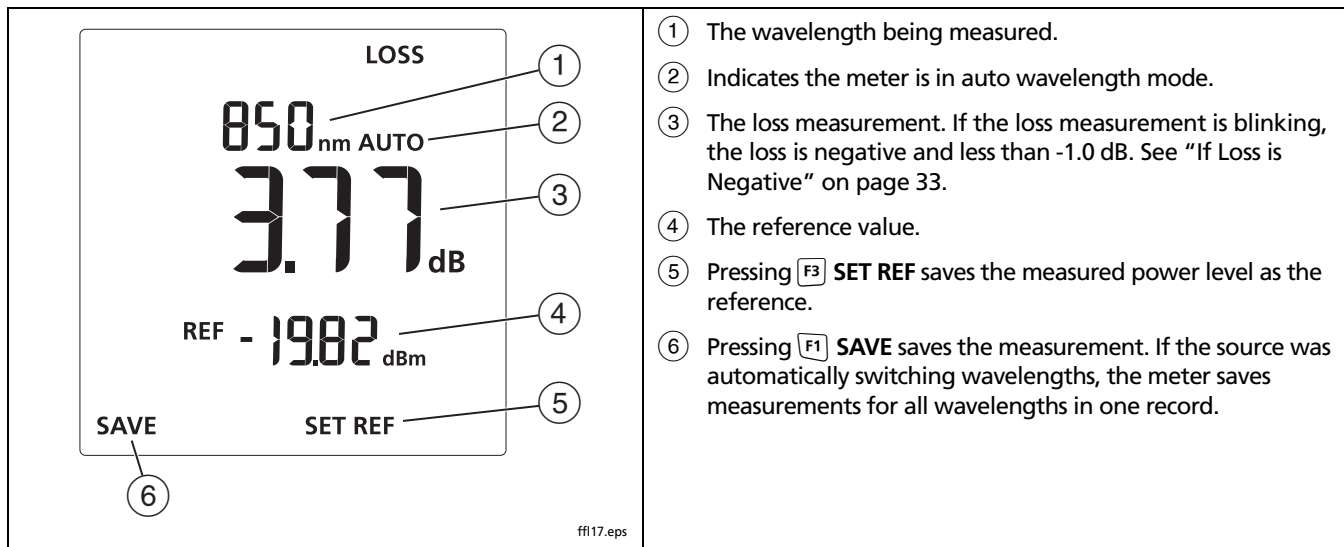

Figure 12. Loss Measurement Display

If Loss is Negative

A negative loss measurement means the reference power level is less than the measured power level. This can be caused by the following:

- The fiber ends were dirty during referencing.
- The connections to the source were disturbed after referencing.
- There was a kink in a reference test cord during referencing.
- The connectors were not properly aligned during referencing.
- The meter and source were not set to the same wavelengths during referencing or testing.
- The testers were much colder during referencing than during testing.
- You did not allow enough time for the source to warm up before setting the reference.
- You measured loss on a fiber that is shorter than the reference test cord used to set the reference.

If loss is negative, set the reference again and retest the link.

Memory Functions

The meter stores up to 1000 loss or power records. If memory is full, the meter shows **FULL** when you try to save a measurement.

Viewing and Deleting Records

To view records, press **MODE** until **VIEW RECORD** appears. See Figure 13.

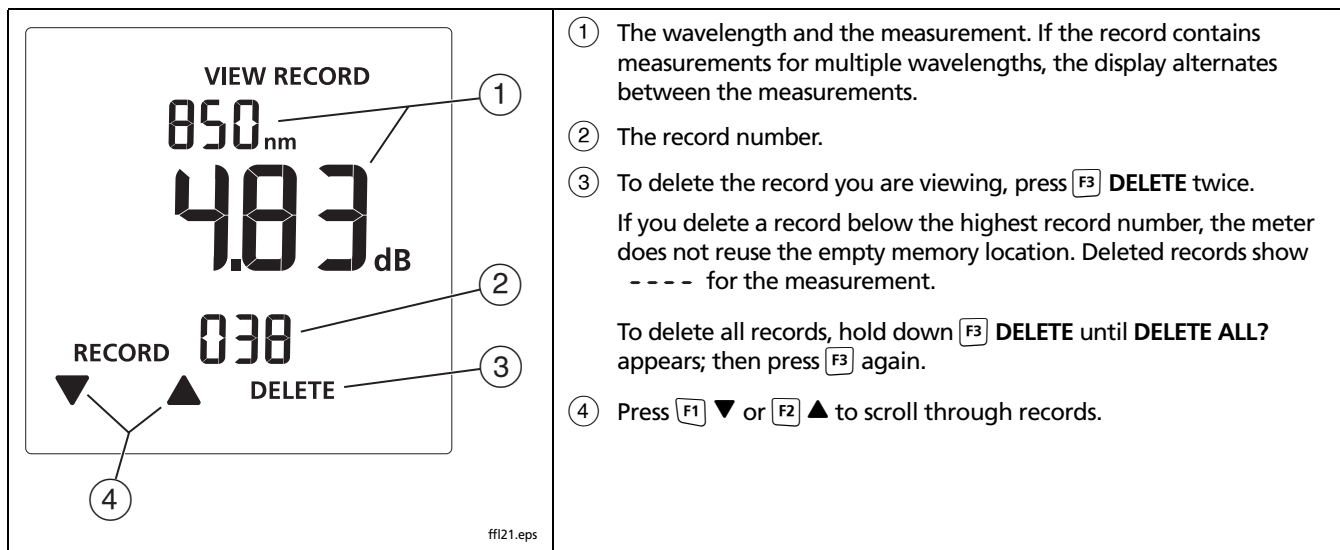



Figure 13. View Record Display

Uploading Records to a PC

- 1 Install the latest version of LinkWare software on your PC.
- 2 Turn on the meter.
- 3 Connect the meter to the PC with the USB cable provided, as shown in Figure 14.
- 4 Start LinkWare software on the PC.
- 5 Click **Import**  on the LinkWare tool bar; then select **SimpliFiber Pro**.
- 6 Enter project information; then click **OK**.
- 7 Import all records from the meter or select records to import.

Note

The meter's record numbers are in the Cable ID column in LinkWare.

- 8 To delete all records in the tester, select **Utilities > SimpliFiber Pro > Delete All Tests in Memory**.

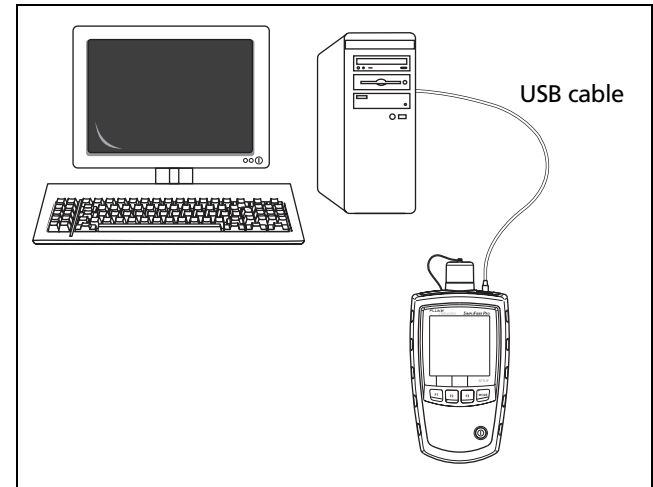

ffi22.eps

Figure 14. Connecting to a PC

Maintenance

Warning

To avoid possible fire, electric shock, personal injury, or damage to the tester:

- Do not open the case. No user-serviceable parts are inside.
- Replacing electrical parts yourself will void the tester's warranty and might compromise its safety features.
- Use only specified replacement parts for user-replaceable items.
- Use only Fluke Networks authorized service centers.

Cleaning

Clean the display with glass cleaner and a soft, lint-free cloth. Clean the case with a soft cloth dampened with water or water and a mild soap.

Caution

To avoid damaging the display or the case, do not use solvents or abrasive cleansers.

Clean the optical connector as described on page 15.

Checking the Meter's Software Version and Calibration Date

Turn the meter on while holding down the **F2** and **F3** keys.

Use **F1** ▼ to toggle between the following:

- **S o F** : Software version
- **F R C** : Factory calibration date. The day and month (DDMM) is on the top line, and the year (YYYY) is on the bottom line.

To exit this mode, turn the meter off.

Options and Accessories

For a complete list of options and accessories visit the Fluke Networks website at www.flukenetworks.com.

Table 5 shows options and accessories available for the SimpliFiber Pro products.

Table 5. Options and Accessories

Option or Accessory	Fluke Networks Model Number
SimpliFiber Pro meter	SFPowerMeter
SimpliFiber Pro singlemode source, 1310 nm/1550 nm	SFSingleModeSource
FindFiber source	FindFiber
Set of 6 FindFiber sources	FindFiber-6
VisiFault™ Visual Fault Locator	VisiFault
FT500 FiberInspector™ Mini Video Microscope	FT500
FT120 FiberViewer™ Microscope, 200X	FT120
FT140 FiberViewer™ Microscope, 400X	FT140
Fiber Optic Cleaning Kit with carrying case	NFC-Kit-Case

-continued-

Table 5. Options and Accessories (continued)

Option or Accessory	Fluke Networks Model Number
SC connector adapter	NFA-SC-SINGLE
LC connector adapter	NFA-LC-SINGLE
ST connector adapter	NFA-ST-SINGLE
ST/ST singlemode fiber optic adapter	NF300SM
SC/SC singlemode fiber optic adapter	NF310SM
SC 62.5 μm simplex reference test cord kit (two 1 m cords: SC/SC and SC/SC)	NFK1-SMPLX-SC
LC 62.5 μm simplex reference test cord kit (two 1 m cords: LC/LC and LC/SC)	NFK1-SMPLX-LC
ST 62.5 μm simplex reference test cord kit (two 1 m cords: ST/ST and ST/SC)	NFK1-SMPLX-ST
SC 50 μm simplex reference test cord kit (two 1 m cords: SC/SC and SC/SC)	NFK2-SMPLX-SC
LC 50 μm simplex reference test cord kit (two 1 m cords: LC/LC and LC/SC)	NFK2-SMPLX-LC
ST 50 μm simplex reference test cord kit (two 1 m cords: ST/ST and ST/SC)	NFK2-SMPLX-ST

Table 5. Options and Accessories (continued)

Option or Accessory	Fluke Networks Model Number
SC singlemode simplex reference test cord kit (two 1 m cords: SC/SC and SC/SC)	NFK3-SMPLX-SC
LC singlemode simplex reference test cord kit (two 1 m cords: LC/LC and LC/SC)	NFK3-SMPLX-LC
ST singlemode simplex reference test cord kit (two 1 m cords: ST/ST and ST/SC)	NFK3-SMPLX-ST
Red multimode fiber mandrel for 50 μm fiber with 3 mm jackets	NF-MANDREL-50
Gray multimode fiber mandrel for 62.5 μm fiber with 3 mm jackets	NF-MANDREL-625
Multimode fiber mandrel kit containing two red 50 μm mandrels and two gray 62.5 μm mandrels	NFK1-MANDREL-KIT

Specifications

Environmental Specifications

Operating temperature	-10°C to +50°C
Storage temperature	-20°C to +50°C

Meter Specifications

Detector type	InGaAs
Calibrated wavelengths	850 nm, 1300 nm, 1310 nm, 1490 nm, 1550 nm, 1625 nm
Measurement range	+10 dBm to -52 dBm (850 nm) +10 dBm to -60 dBm (1300 nm, 1310 nm, 1490 nm, 1550 nm, 1625 nm)
Power measurement linearity	± 0.2 dB (850 nm) ¹ ± 0.1 dB (1300 nm, 1310 nm, 1490 nm, 1550 nm, 1625 nm) ²
Power measurement uncertainty ³	± 0.25 dB

1. For 850 nm, ± 0.2 dB for power from 0 dBm to -45 dBm, ± 0.25 dB for power < -45 dBm.
2. ± 0.1 dB for power from 0 dBm to -55 dBm. ± 0.2 dB for power > 0 dBm and < -55 dBm.
3. 23°C $\pm 2^\circ$ C, power level -20 dBm, continuous wave, 62.5/125 μ m at multimode wavelengths, 9/125 μ m at 1310 nm, 1490 nm, 1550 nm, and 1625 nm; add 0.1 dB for 1625 nm.

Meter Specifications (cont.)

Display resolution, dB or dBm	0.01 dB
Power display units	dBm, mW, μ W
Auto-wavelength detection	Yes
Record storage	1000 records, multiple wavelengths per record, sequential-number ID
External interface	USB 2.0, full speed
Optical connector	Removable adapter. SC adapter is standard. Optional adapters include LC, ST, FC
FindFiber ID detection	Yes
Power requirement	2 AA alkaline batteries
Battery life⁴	>50 hours (typical)
Automatic power-off	10, 20, 30, or 60 minutes (can be disabled by the user)
Low battery warning	Low battery icon blinks
Size	6.4 in x 3.2 in x 1.5 in (16.5 cm x 8.0 cm x 3.9 cm)
Weight	11.5 oz (325 g)
4. Measured power levels ≤ 0 dBm. Battery life depends on the condition and type of batteries used. Fluke Networks recommends alkaline batteries.	

Multimode Source

Emitter type	LED
Central wavelength	850 nm, 1300 nm
Wavelength accuracy	850 nm: +30 nm/-10 nm 1300 nm: ± 20 nm
Spectral width (FWHM)	850 nm: 50 nm (typical) 1300 nm: 135 nm (typical)
Minimum output power	850/1300 nm: ≥ -20 dBm
Power output stability¹	± 0.1 dB over 8 hours
Auto dual-wavelength switching	Yes. Can be enabled or disabled by the user.
Optical output connector	Fixed SC
FindFiber ID generation	Yes. Fixed at ID 1.
Modes	CW (continuous wave), 2 kHz modulated, auto-wavelength
1. 23°C $\pm 2^\circ$ C, after 5 minutes of warm-up time.	

Multimode Source (cont.)

Power requirement	2 AA alkaline batteries
Battery life²	40 hours (typical)
Automatic power off	30 minutes (can be disabled by the user)
Low battery warning	LED blinks
Size	5.6 in x 3.2 in x 1.6 in (14.2 cm x 8.1 cm x 4.1 cm)
Weight	9.8 oz (278 g)
2. In auto-wavelength mode. Battery life depends on the condition and type of batteries used. Fluke Networks recommends alkaline batteries.	

Singlemode Source

Emitter type	FP laser: dual 1310 nm/1550 nm
Central wavelength	1310 nm, 1550 nm
Wavelength accuracy	1310 nm: ± 20 nm 1550 nm: ± 30 nm
Spectral bandwidth (RMS)	1310 nm: 2 nm (maximum) 1550 nm: 3 nm (maximum)
Minimum output power	1310 nm/1550 nm: ≥ -7 dBm (typical)
Power output stability¹	± 0.25 dB over 8 hours
Auto dual-wavelength switching	Yes. Can be enabled or disabled by the user.
Optical output connector	Fixed SC
FindFiber ID generation	Yes. Fixed at ID 2.
Modes	CW (continuous wave), 2 kHz, auto-wavelength
1. 23°C $\pm 2^\circ$ C, after 5 minutes of warm-up time.	

Singlemode Source (cont.)

Power requirement	2 AA alkaline batteries
Battery life²	30 hours (typical)
Automatic power off	30 minutes (Can be enabled or disabled by the user.)
Low battery warning	LED blinks
Size	5.6 in x 3.2 in x 1.6 in (14.2 cm x 8.1 cm x 4.1 cm)
Weight	9.8 oz (278 g)
2. In auto-wavelength mode. Battery life depends on the condition and type of batteries used. Fluke Networks recommends alkaline batteries.	

FindFiber Source Specifications

Emitter type	Laser
Source connector	Fixed SC
FindFiber ID numbers	1 through 8. Default is 3.
Power indicator	LED
Power requirement	2 AA alkaline batteries
Battery life	>80 hours (typical)
Automatic power-off	30 minutes
Low battery indicator	Blinking LED
Size	7.1 in x 1.3 in x 1.0 in (17.9 cm x 3.2 cm x 2.5 cm)
Weight	4.4 oz (125 g)

Certifications, Compliance, and Regulatory Information



Conforms to relevant European Union directives



N10140

Conforms to relevant Australian standards



Listed by the Canadian Standards Association

Laser safety

Complies with 21CFR.1040.10,11, and EN60825-1, 2:2007 (Class 1, Hazard Level 1)

Appendix A: Using Mandrels

You should use mandrels when testing multimode fiber. Mandrels can improve measurement repeatability and consistency. They also allow the use of LED light sources to certify 50 μm and 62.5 μm fiber links for current and planned high bit-rate applications, such as Gigabit Ethernet and 10 Gigabit Ethernet. Mandrels are available from Fluke Networks.

Caution

Do not use mandrels when testing singlemode fiber.

Figure A-1 shows how to wrap the fiber around a mandrel. Place the mandrel at the source's output, as shown in Figure A-2.

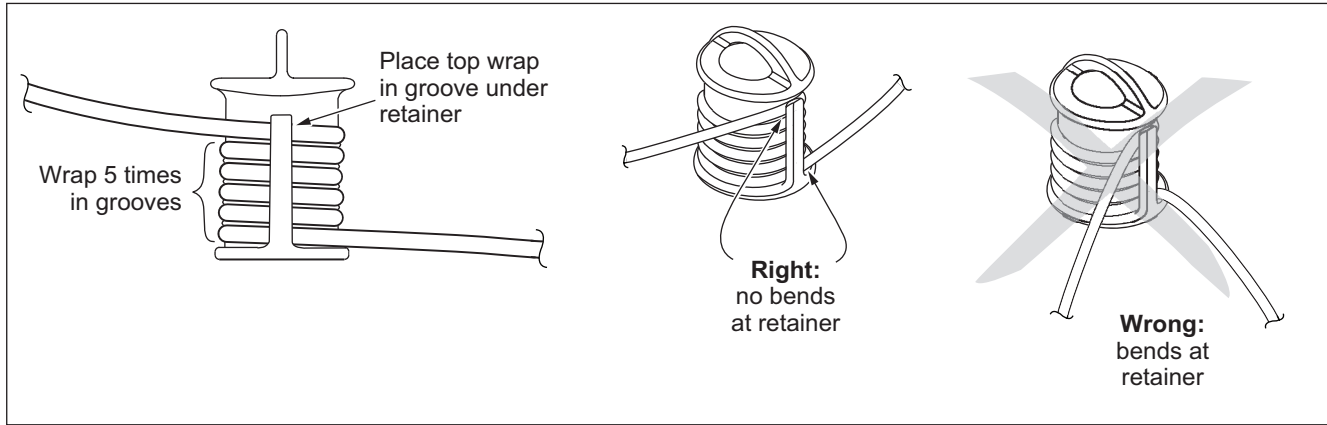

amd67.eps

Figure A-1. Wrapping a Reference Test Cord Around a Mandrel

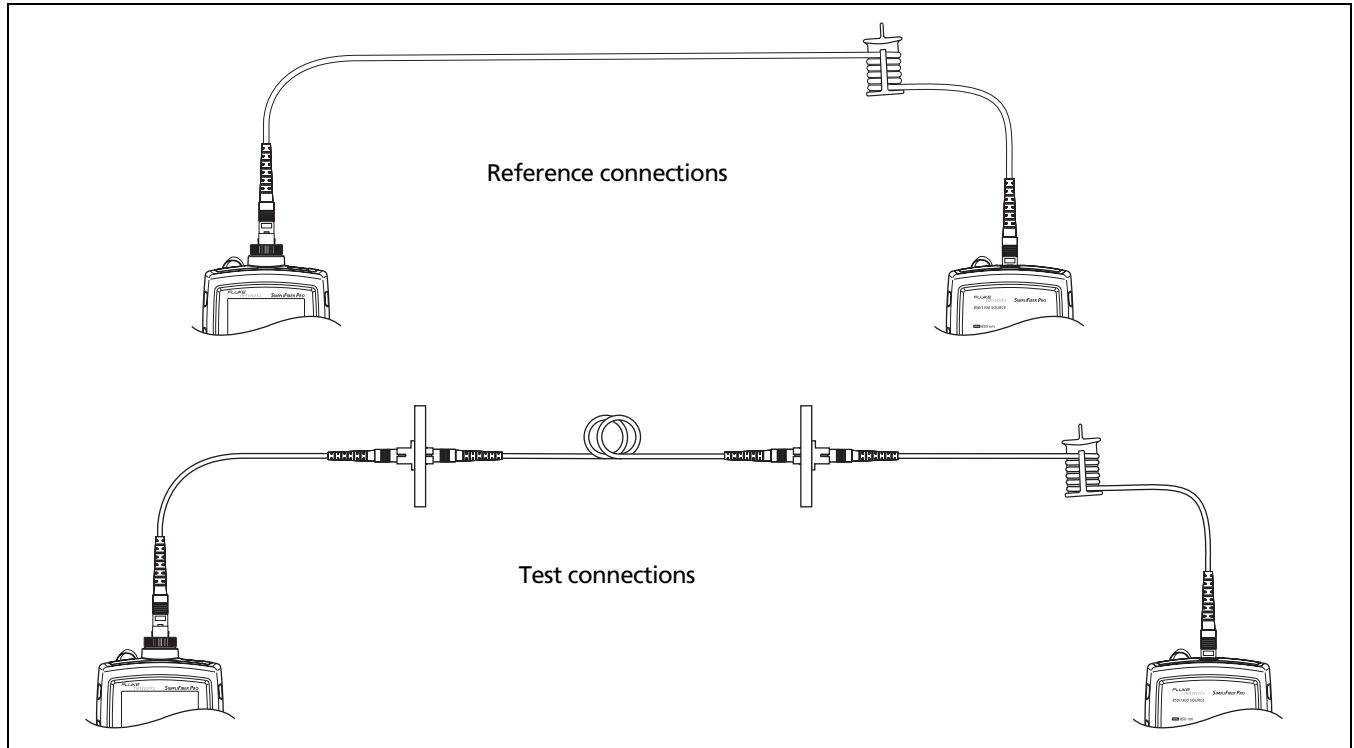

Figure A-2. Mandrel Placement

ff16.eps

Appendix B: Fiber Test Method Names

Industry standards use different names for equivalent fiber test methods. Table B-1 shows the names used in this manual and by four common industry standards for the three fiber test methods.

Table B-1. Test Method Names

Link End Connections Included in Loss Results	This Manual	TIA/EIA-526-14A (multimode)	TIA/EIA-526-7 (singlemode)	IEC 61280-4-1 (multimode)	IEC 61280-4-2 (singlemode)
1 connection	Method A	Method A	Method A.2	Method 1	Method A2
2 connections	Method B	Method B	Method A.1	Method 2	Method A1
None	Method C	Method C	Method A.3	Method 3	Method A3

Appendix C: Loss Test Methods

Introduction

Note

The following discussion uses TIA/EIA-526 terminology for the names of the three common test methods. See Appendix B for a cross-reference of the method names in various standards.

The number of fiber connections represented in loss test results depends on the reference and test connections. This appendix describes the three common methods, Methods A, B, and C.

Note

See Appendix B for a cross-reference of the method names in various standards.

This appendix also describes modified connections you can use if you do not have the correct connector adapters for the meter.

Method A/A.2

Method A/A.2 results account for the loss of one connection plus the fiber in the link. This method is suitable for links where the fiber's loss is a significant portion of the total loss, such as when the link is long or a patch cord is used at only one end. Method A is defined in the ANSI/TIA/EIA-526-14A multimode standard. Method A.2 is defined in the ANSI/TIA/EIA-526-7 singlemode standard.

Method A/A.2 reference connections cancel out the effects of one connection and two reference test cords, as shown in Figure C-3.

The test connections add one connection, plus the fiber in the link, to each path. Loss results for Method A/A.2 therefore represent only one connection plus the fiber in the link. Because the results omit one connection, ANSI/TIA/EIA-526-14A and 526-7 do not recommend Method A/A.2 for testing premises fiber, where patch cords are typically used at both ends of a link and connector loss is a significant portion of total loss.

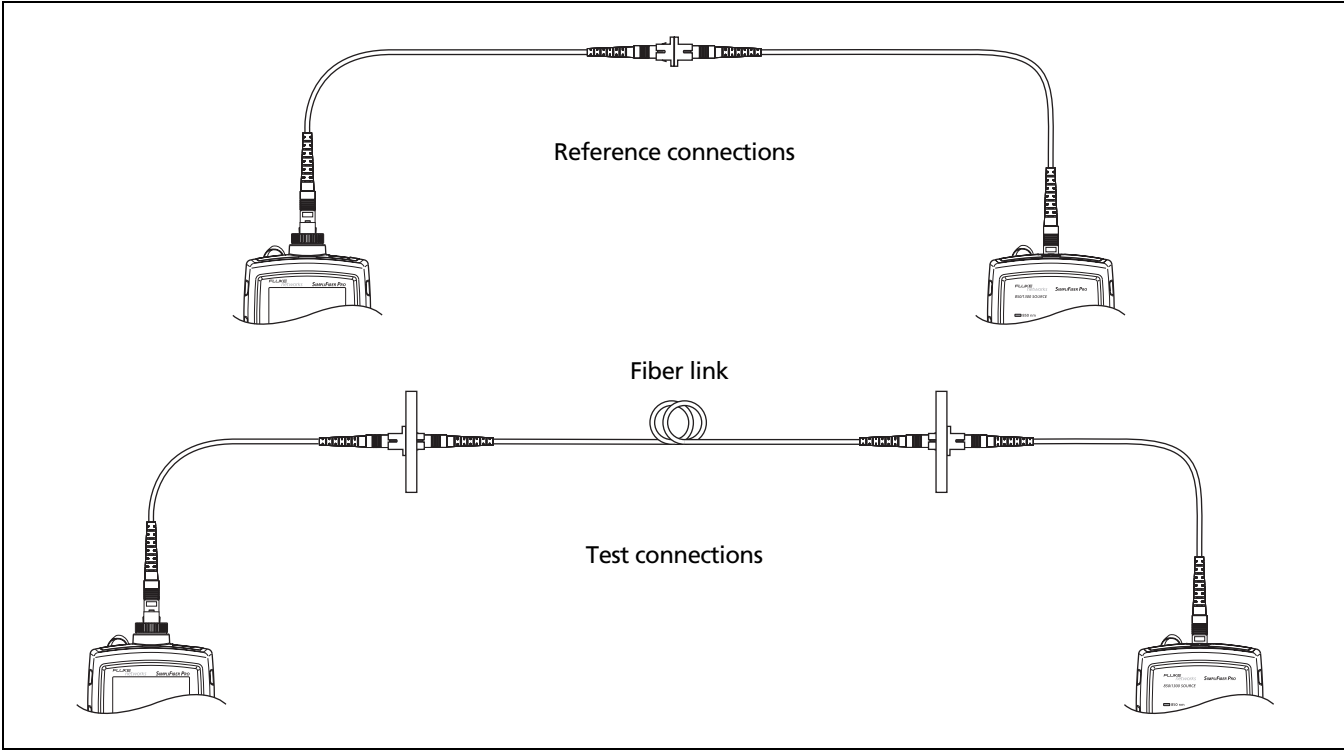

ff10.eps

Figure C-3. Method A/A.2 Reference and Test Connections

Method B/A.1

Method B/A.1 results account for the loss of two connections plus the fiber in the link. This method is suitable for testing premises fiber, where patch cords are typically used at both ends of the link and connector loss is a significant portion of the total loss. Method B is defined in the ANSI/TIA/EIA-526-14A multimode standard. Method A.1 is defined in the ANSI/TIA/EIA-526-7 singlemode standard.

Method B/A.1 reference connections cancel out the effects of the reference test cords, as shown in Figure C-4.

Loss results for Method B/A.1 therefore represent both connections plus the fiber in the link. ANSI/TIA/EIA-526-14A and 526-7 specify Methods B and A.1 for testing multimode and singlemode premises fiber, where connector loss is a significant portion of the total loss.

Note

To get Method B results when you do not have the correct connector adapters for the meter, see “Modified Method B” on page 62.

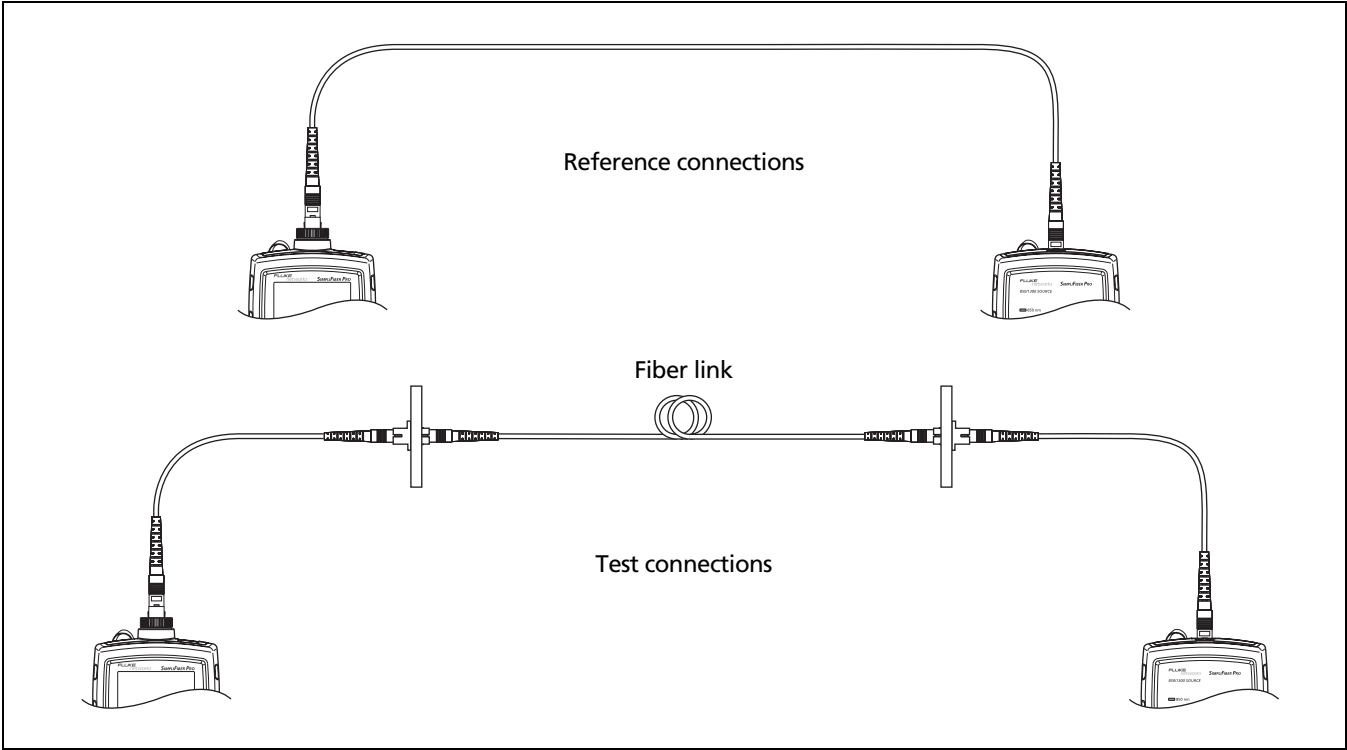

Figure C-4. Method B/A.1 Reference and Test Connections

ff111.eps

Method C/A.3

Method C/A.3 results account for the loss of only the fiber in the link. This method is suitable for testing links where the fiber's loss is the majority of the total loss, such as when the link is very long or patch cords are not used at either end. Method C is defined in the ANSI/TIA/EIA-526-14A multimode standard. Method A.3 is defined in the ANSI/TIA/EIA-526-7 singlemode standard.

Method C/A.3 reference connections cancel out the effects of two connections and the reference test cords, as shown in Figure C-5.

The test connections add only the fiber in link. Loss results for Method C/A.3 therefore represent only the fiber in the link.

Because the results omit both connections in the link, ANSI/TIA/EIA-526-14A and 526-7 do not recommend Method C/A.3 for testing premises fiber, where patch cords are typically used at both ends of the link and connector loss is a large portion of the total loss.

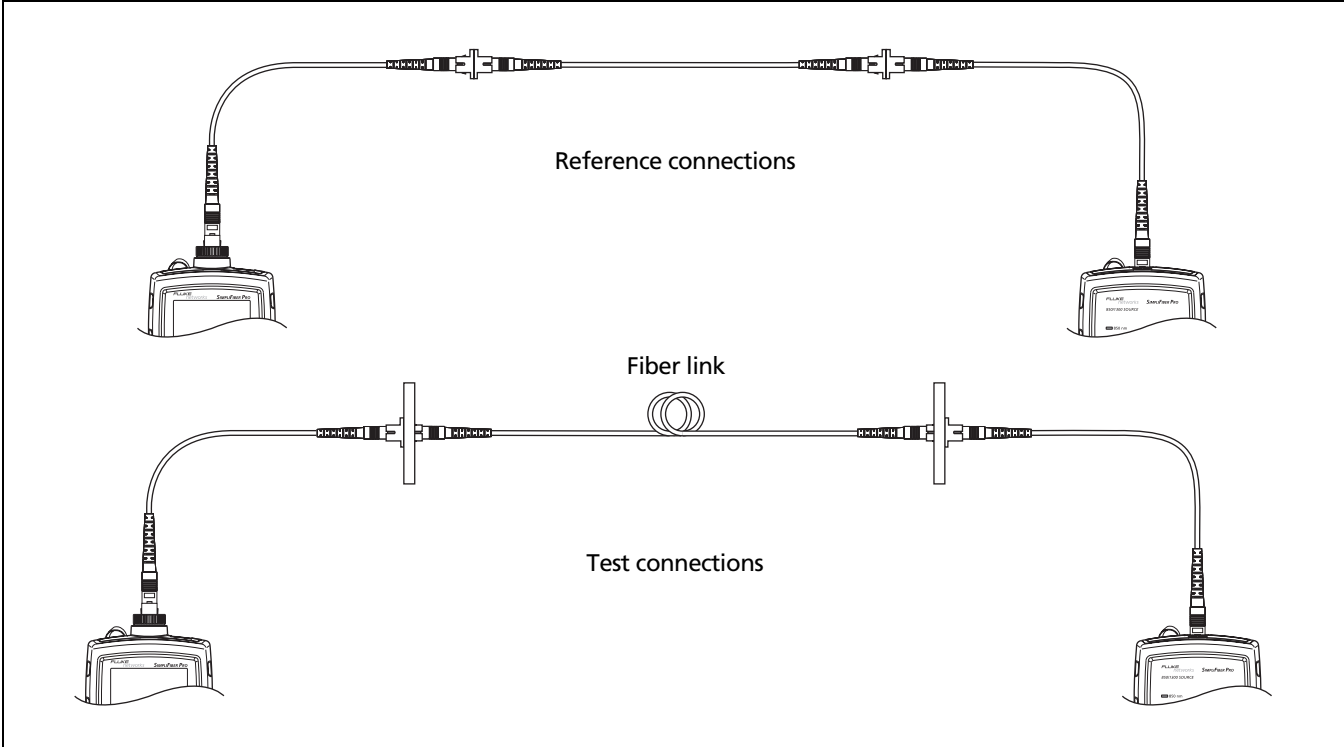

Figure C-5. Method C/A.3 Reference and Test Connections

ff112.eps

Modified Method B/A.1

This section describes modified reference and test connections that produce Method B/A.1 results. Use these connections if you need Method B/A.1 results but do not have connector adapters that match the connectors on the link. This method lets you connect to the link without disturbing the source's output connections after setting the reference.

Figure C-6 shows reference and test connections for one fiber in a duplex cable with LC connectors.

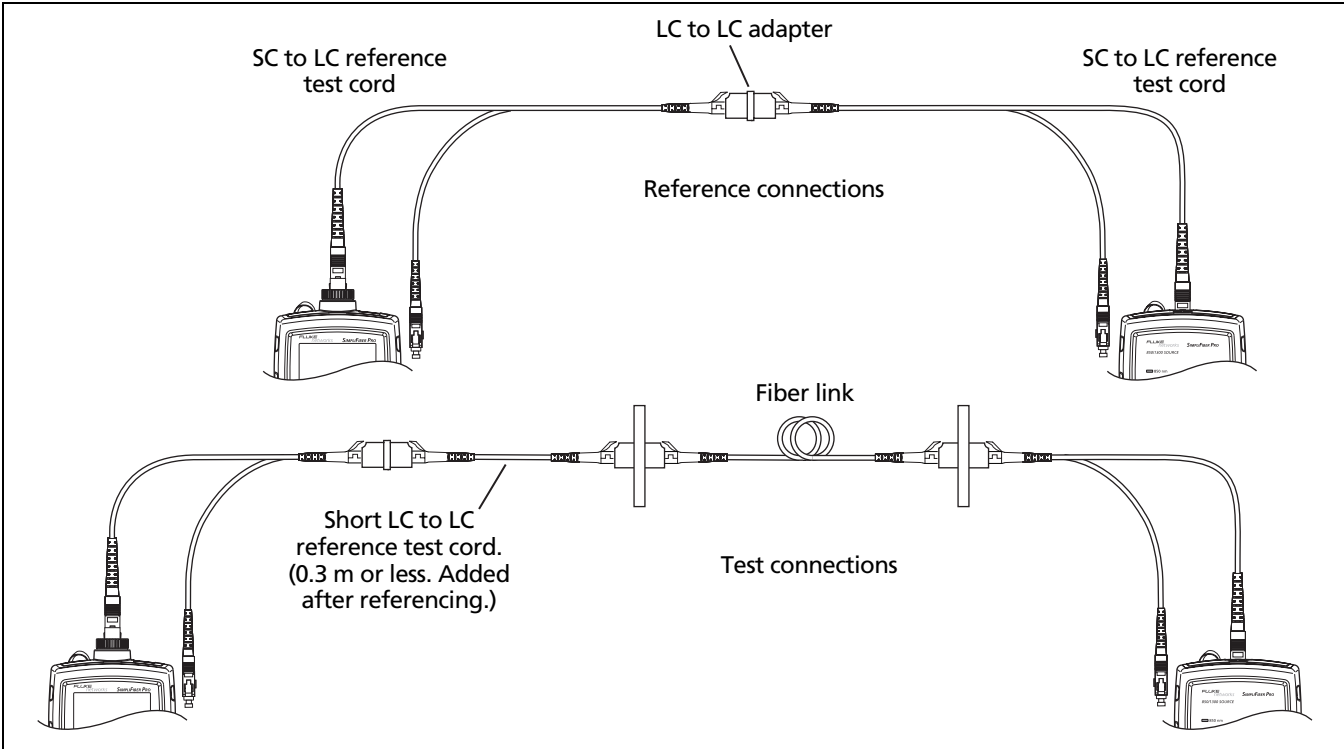

Figure C-6. Modified Method B/A.1 Reference and Test Connections

ff13.eps

Index

-2-

2 kHz modulated mode, 14

-A-

accessories

 optional, 37

 standard, 4

auto power-off, 13

auto wavelength mode, 14

-B-

backlight, 13

batteries, 7

-C-

calibration date, 36

cautions, 4

certifications and compliance, 47

CheckActive mode, 18

cleaning

 connectors and adapters, 15

 display and case, 36

connections

 fiber loss test methods, 55

 locating fibers, 21

 loss measurement, 31

 Method A, 57

 Method B, 59

 modified Method B, 63

 Method C, 61

 PC, 35

 power measurement, 23

 reference, 28

connector adapter, 16

connectors, 9

continuous wave mode, 14

customer support, 2

–D–

deleting records, 34, 35
detecting active fibers, 18
display features, 10

–F–

FindFiber mode, 20
Fluke Networks
 contacting, 2
 Knowledge Base, 2

–H–

help (contacting Fluke Networks), 2

–I–

ID, 20

–K–

keys, 9
Knowledge Base, 2

–L–

locating fibers, 20

loss

display, 32
measuring, 30
negative, 33
setting the reference, 27
test methods, 55

–M–

maintenance, 36
mandrels, 49
memory, 34
Method A/A.2, 56
Method B/A.1, 58
 modified, 62
Method C/A.3, 60
Method names, 53
minimum/maximum (Min/Max), 25

–N–

negative loss, 33

–O–

options, 37

-P-

patch cords, 26
PC connections, 35
power
 auto power-off, 13
 display, 24
 measuring, 22
 minimum/maximum (Min/Max), 25
 unit of measurement, 13

-R-

records
 number, 34
 uploading to a PC, 35
 viewing and deleting, 34
reference
 about referencing, 27
 fail, 29
 setting the reference, 27
reference test cords, 26
registration, 2

-S-

safety information, 3, 36
setting the reference, 27
setup, 12

specifications, 40

-U-

uploading records to a PC, 35

-V-

version, 36
VIEW RECORD display, 34

