



# PJM2312NSA

## N-Channel Enhancement Mode Power MOSFET

### Product Summary

- $V_{DS} = 20V, I_D = 5A$
- $R_{DS(on)} < 28m\Omega @ V_{GS} = 4.5V$
- $R_{DS(on)} < 35m\Omega @ V_{GS} = 2.5V$

### Features

- Advanced Trench Technology
- RoHS and Reach Compliant
- Halogen and Antimony Free
- Moisture Sensitivity Level 1

### Application

- Load Switch
- PWM Application

### Marking Code

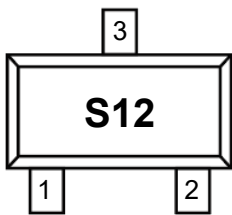

### SOT-23

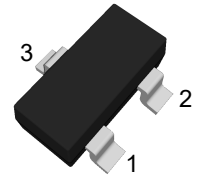

(Top View)

Pin	Description
1	Gate
2	Source
3	Drain

### Schematic Diagram

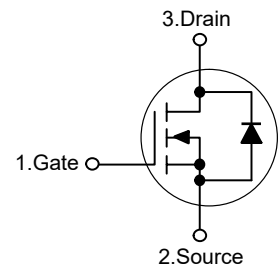

### Absolute Maximum Ratings

( $T_a = 25^\circ C$  unless otherwise specified)

Parameter	Symbol	Value	Unit
Drain-Source Voltage	$V_{DS}$	20	V
Gate-Source Voltage	$V_{GS}$	$\pm 10$	V
Drain Current-Continuous	$I_D$	5	A
Drain Current-Pulsed <sup>Note1</sup>	$I_{DM}$	20	A
Maximum Power Dissipation	$P_D$	1	W
Junction Temperature	$T_J$	150	$^\circ C$
Storage Temperature Range	$T_{STG}$	-55 to +150	$^\circ C$

### Thermal Characteristics

Thermal Resistance, Junction-to-Ambient <sup>Note2</sup>	$R_{\theta JA}$	125	$^\circ C/W$
--	-----------------	-----	--------------



# PJM2312NSA

## N-Channel Enhancement Mode Power MOSFET

### Electrical Characteristics

(Ta=25°C unless otherwise specified)

Parameter	Symbol	Test Condition	Min.	Typ.	Max.	Unit
<b>Static Characteristics</b>						
Drain-Source Breakdown Voltage	$V_{(BR)DSS}$	$V_{GS}=0V, I_D=250\mu A$	20	--	--	V
Zero Gate Voltage Drain Current	$I_{DSS}$	$V_{DS}=20V, V_{GS}=0V$	--	--	1	$\mu A$
Gate-Body Leakage Current	$I_{GSS}$	$V_{GS}=\pm 10V, V_{DS}=0V$	--	--	$\pm 100$	nA
Gate Threshold Voltage <sup>Note2</sup>	$V_{GS(th)}$	$V_{DS}=V_{GS}, I_D=250\mu A$	0.5	0.7	1	V
Drain-Source On-Resistance <sup>Note2</sup>	$R_{DS(on)}$	$V_{GS}=4.5V, I_D=4.5A$	--	18	28	m $\Omega$
		$V_{GS}=2.5V, I_D=4A$	--	22	35	m $\Omega$
Forward Transconductance <sup>Note2</sup>	$g_{FS}$	$V_{DS}=15V, I_D=5A$	--	25	--	S
<b>Dynamic Characteristics</b>						
Input Capacitance	$C_{iss}$	$V_{DS}=8V, V_{GS}=0V, f=1MHz$	--	500	--	pF
Output Capacitance	$C_{oss}$		--	295	--	pF
Reverse Transfer Capacitance	$C_{rss}$		--	96	--	pF
Total Gate Charge	$Q_g$	$V_{DS}=10V, I_D=3A, V_{GS}=4.5V$	--	10	--	nC
Gate-Source Charge	$Q_{gs}$		--	2.3	--	nC
Gate-Drain Charge	$Q_{gd}$		--	2.9	--	nC
<b>Switching Characteristics</b>						
Turn-on Delay Time	$t_{d(on)}$	$V_{DD}=10V, I_D=1A, V_{GS}=4.5V, R_{GEN}=6\Omega$	--	11	--	nS
Turn-on Rise Time	$t_r$		--	30	--	nS
Turn-off Delay Time	$t_{d(off)}$		--	35	--	nS
Turn-off Fall Time	$t_f$		--	10	--	nS
<b>Source-Drain Diode Characteristics</b>						
Diode Forward Voltage <sup>Note3</sup>	$V_{SD}$	$V_{GS}=0V, I_S=5A$	--	--	1.2	V
Diode Forward Current <sup>Note2</sup>	$I_S$		--	--	5	A

Note: 1. Repetitive Rating: Pulse width limited by maximum junction temperature.

2. Surface Mounted on FR4 Board,  $t \leq 10$  sec.

3. Pulse Test: Pulse width  $\leq 300\mu s$ , duty cycle  $\leq 2\%$ .



### Typical Characteristic Curves

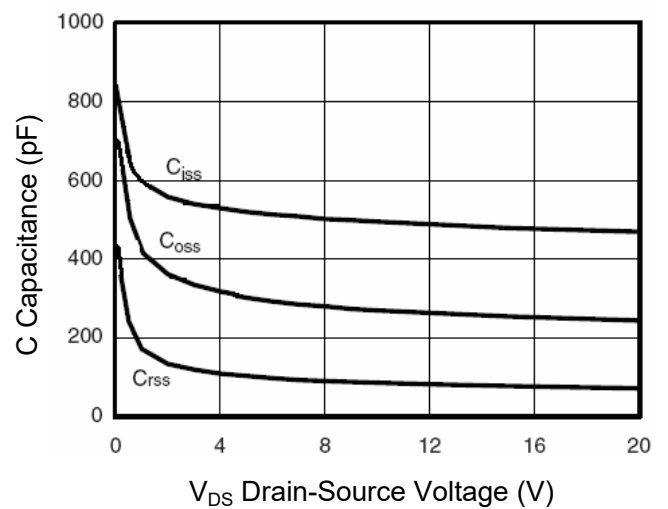
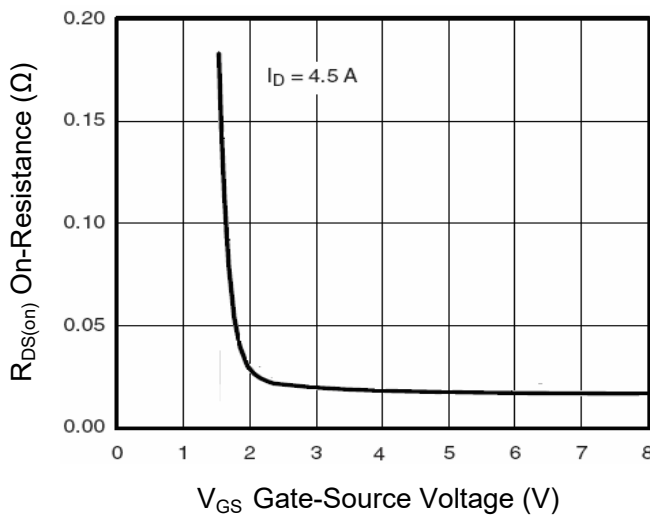
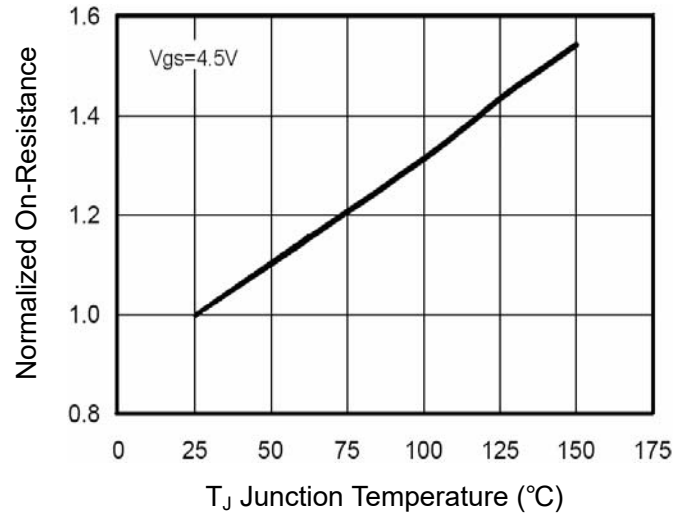
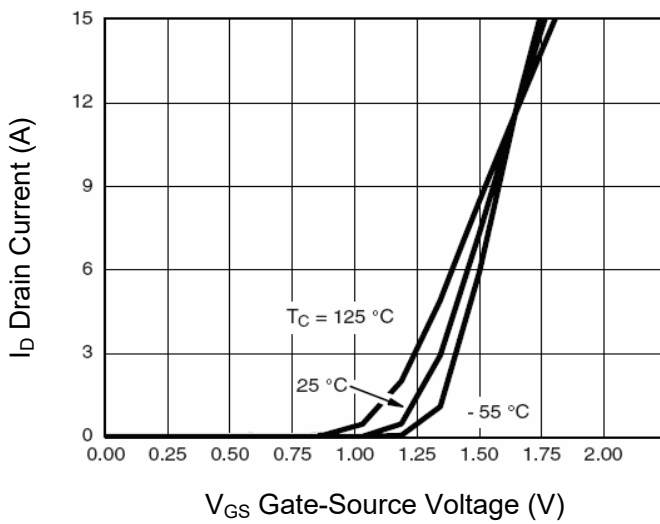
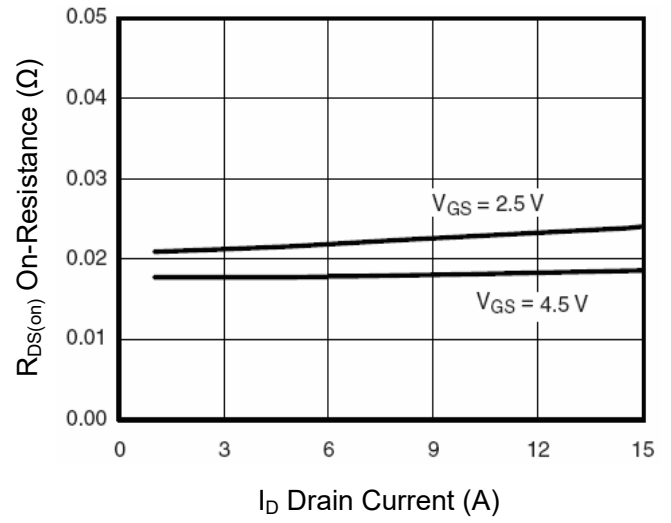
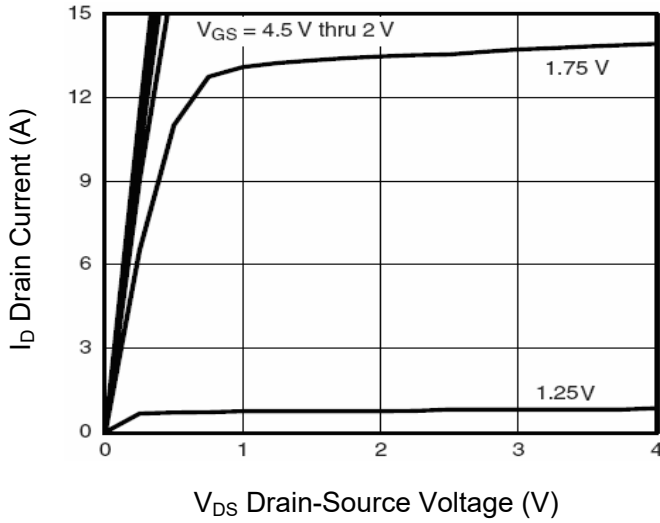



# PJM2312NSA

## N-Channel Enhancement Mode Power MOSFET

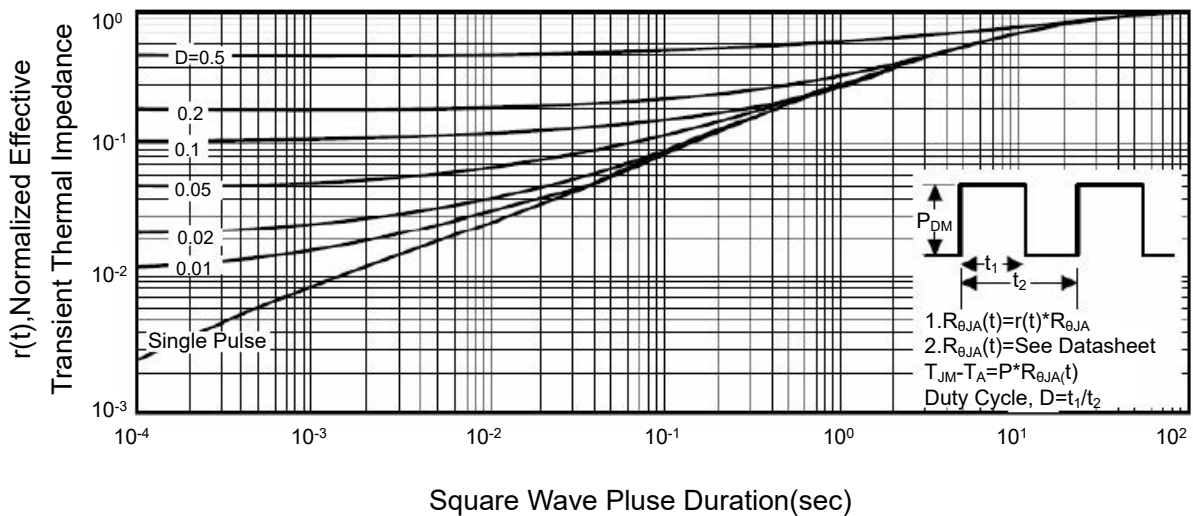
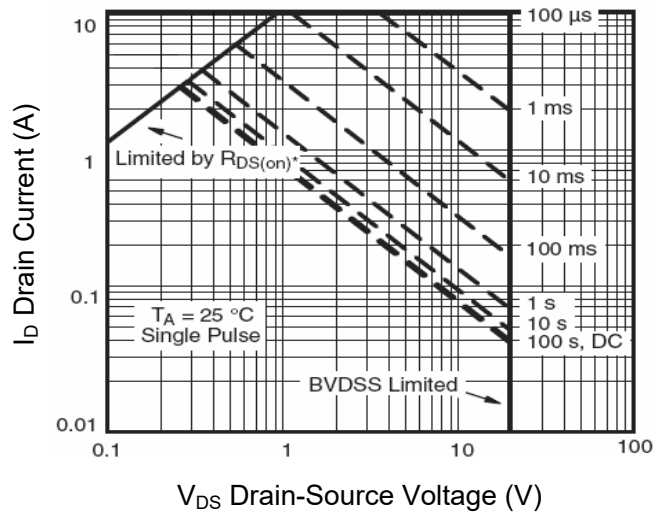
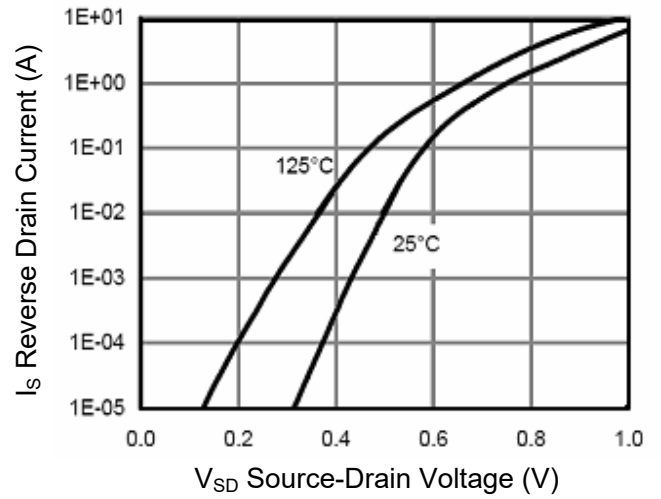
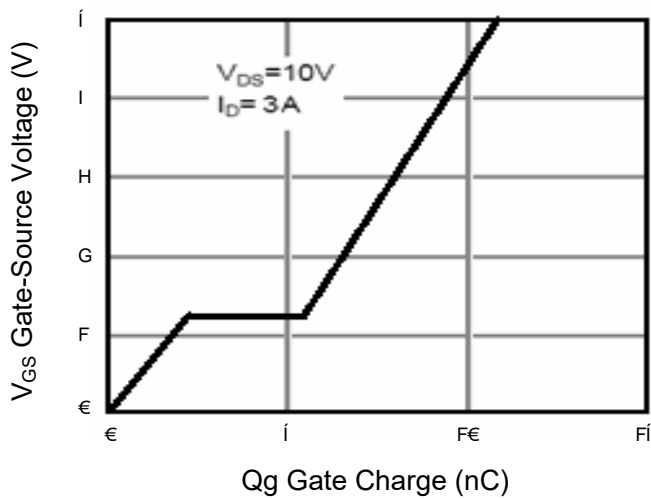

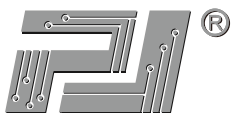

# PJM2312NSA

## N-Channel Enhancement Mode Power MOSFET

### Package Outline

SOT-23

Dimensions in mm

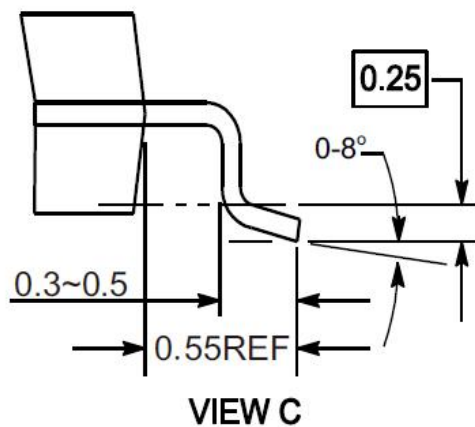
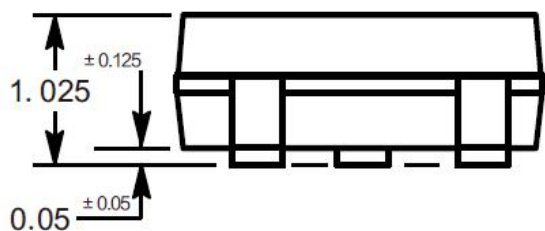
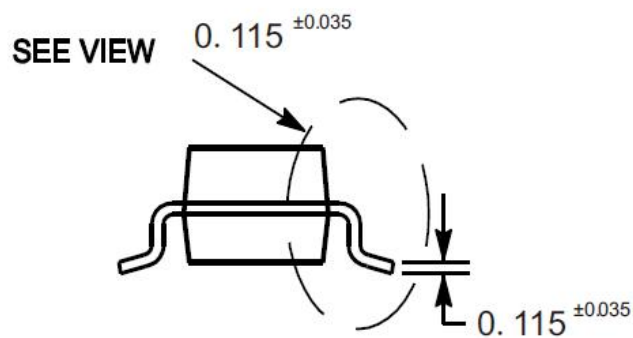
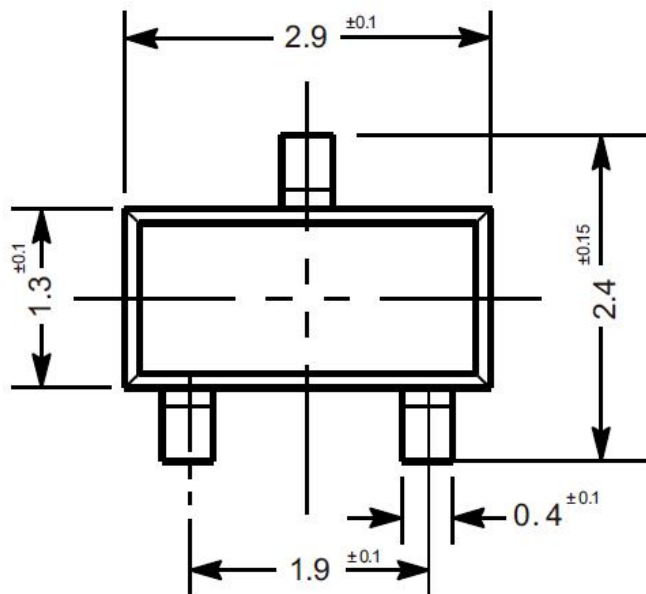

### Ordering Information

Device	Package	Shipping
PJM2312NSA	SOT-23	3,000PCS/Reel&7inches



### Conditions of Soldering and Storage

#### ◆ Recommended condition of reflow soldering

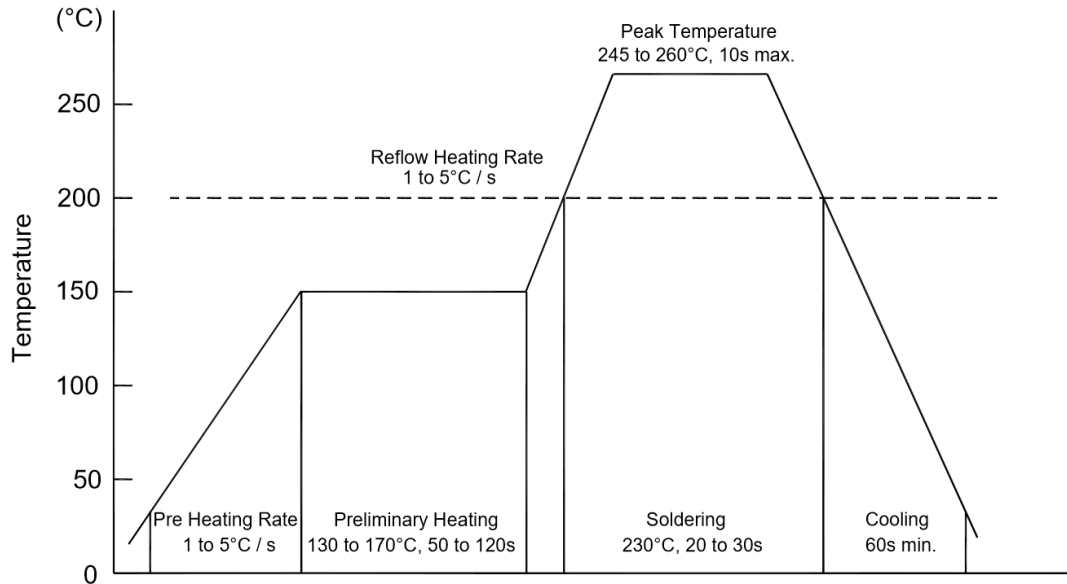

Recommended peak temperature is over 245 °C. If peak temperature is below 245 °C, you may adjust the following parameters:

- Time length of peak temperature (longer)
- Time length of soldering (longer)
- Thickness of solder paste (thicker)

#### ◆ Conditions of hand soldering

- Temperature: 370 °C
- Time: 3s max.
- Times: one time

#### ◆ Storage conditions

- **Temperature**  
5 to 40 °C
- **Humidity**  
30 to 80% RH
- **Recommended period**  
One year after manufacturing

### Package Specifications

- The method of packaging

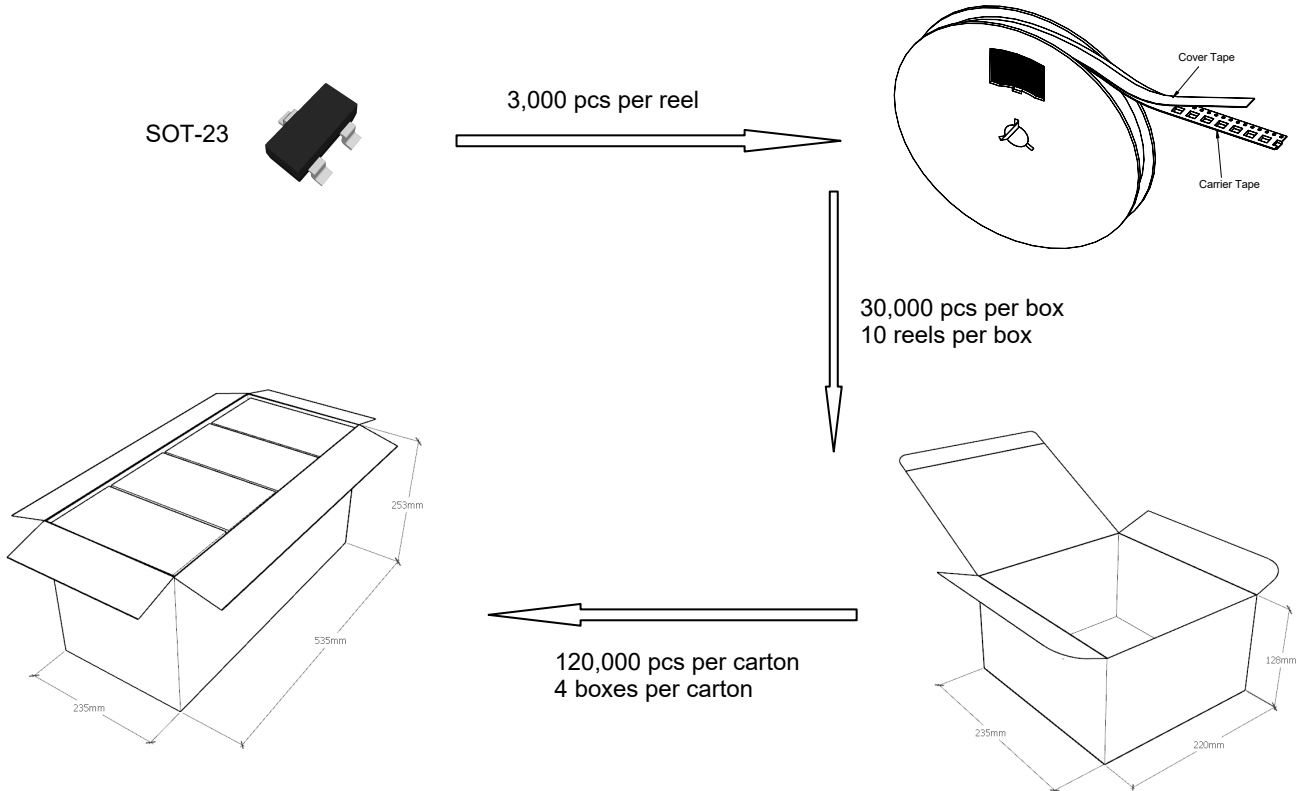

### ◆ Embossed tape and reel data

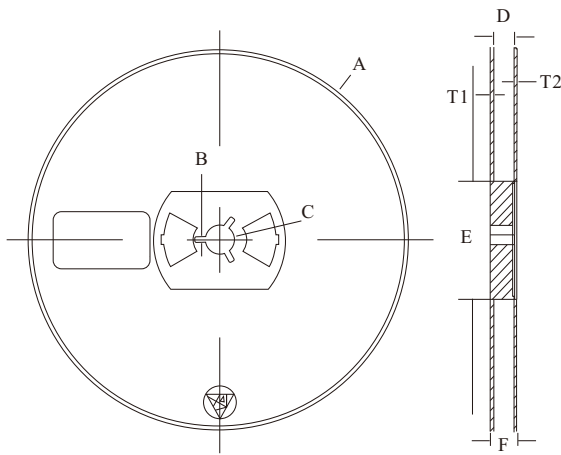

Symbol	Value (unit: mm)
A	Ø 177.8±1
B	2.7±0.2
C	Ø 13.5±0.2
E	Ø 54.5±0.2
F	12.3±0.3
D	9.6+2/-0.3
T1	1.0±0.2
T2	1.2±0.2

Reel (7")

