

SOT-89 Plastic-Encapsulate Voltage Regulators
78L08 Three-terminal positive voltage regulator

SOT-89-3L
FEATURES

- Maximum output current
 I_{OM} : 0.1A
- Output voltage
 V_O : 8V
- Continuous total dissipation
 P_D : 0.6 W ($T_a = 25^\circ\text{C}$)

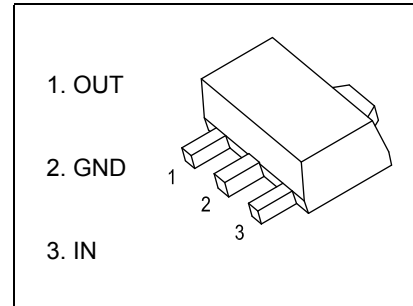

ABSOLUTE MAXIMUM RATINGS (Operating temperature range applies unless otherwise specified)

Parameter	Symbol	Value	Unit
Input Voltage	V_i	30	V
Thermal Resistance from Junction to Ambient	$R_{\theta JA}$	166.7	$^\circ\text{C/W}$
Operating Junction Temperature Range	T_{OPR}	-40~+125	$^\circ\text{C}$
Storage Temperature Range	T_{STG}	-65~+150	$^\circ\text{C}$

ELECTRICAL CHARACTERISTICS AT SPECIFIED VIRTUAL JUNCTION TEMPERATURE ($V_i=14\text{V}, I_o=40\text{mA}, C_i=0.33\mu\text{F}, C_o=0.1\mu\text{F}$, unless otherwise specified)

Parameter	Symbol	Test conditions	Min	Typ	Max	Unit	
Output voltage	V_o	25°C	7.7	8.0	8.3	V	
		0-125 $^\circ\text{C}$	$10.5\text{V} \leq V_i \leq 23\text{V}, I_o = 1\text{mA} - 40\text{mA}$	7.6	8.0	8.4	V
			$I_o = 1\text{mA} - 70\text{mA}$	7.6	8.0	8.4	V
Load Regulation	ΔV_o	$I_o = 1\text{mA} - 100\text{mA}$	25°C	18	80	mV	
		$I_o = 1\text{mA} - 40\text{mA}$	25°C	10	40	mV	
Line regulation	ΔV_o	$10.5\text{V} \leq V_i \leq 23\text{V}$	25°C	42	175	mV	
		$11\text{V} \leq V_i \leq 23\text{V}$	25°C	36	125	mV	
Quiescent Current	I_q	25°C	4	6.0	mA		
Quiescent Current Change	ΔI_q	$11\text{V} \leq V_i \leq 23\text{V}$	0-125 $^\circ\text{C}$		1.5	mA	
	ΔI_q	$1\text{mA} \leq I_o \leq 40\text{mA}$	0-125 $^\circ\text{C}$		0.1	mA	
Output Noise Voltage	V_N	$10\text{Hz} \leq f \leq 100\text{KHz}$	25°C	54		$\mu\text{V}/V_o$	
Ripple Rejection	RR	$13\text{V} \leq V_i \leq 23\text{V}, f=120\text{Hz}$	0-125 $^\circ\text{C}$	37	46	dB	
Dropout Voltage	V_d	25°C		1.7		V	

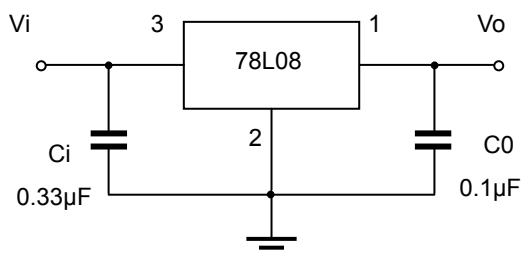
* Pulse test.

TYPICAL APPLICATION

Note: Bypass capacitors are recommended for optimum stability and transient response and should be located as close as

The above data are for reference only.

Typical Characteristics

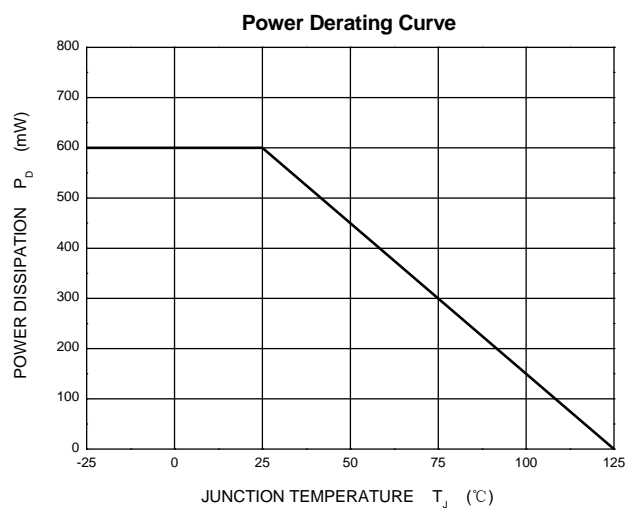
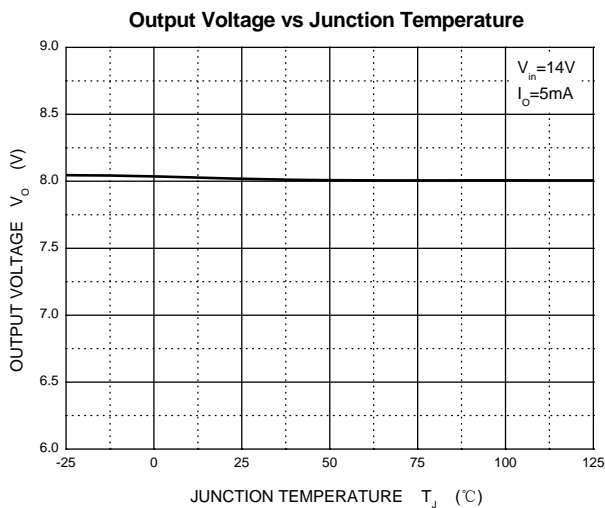
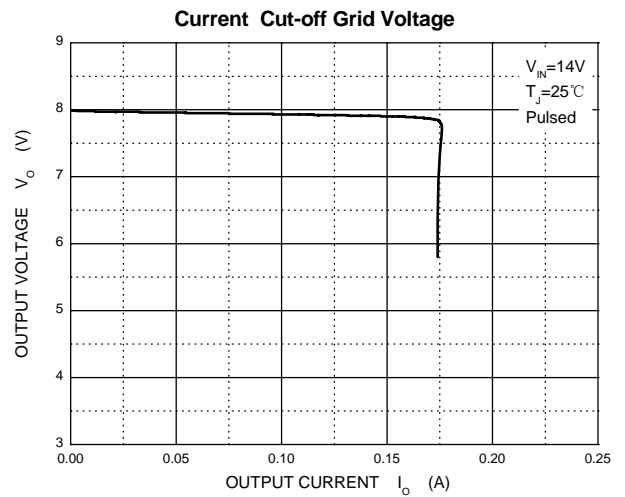
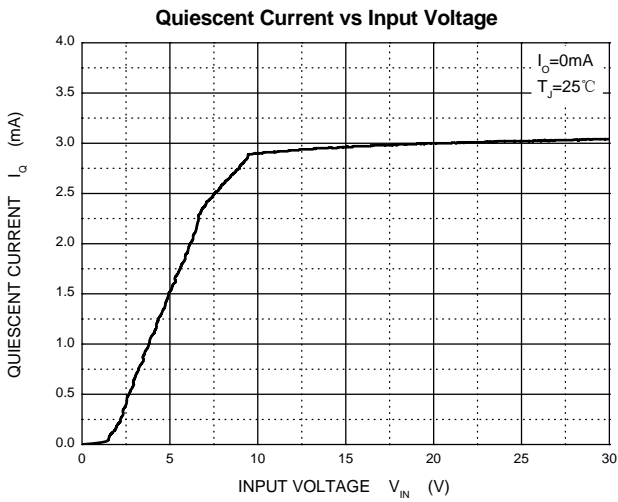
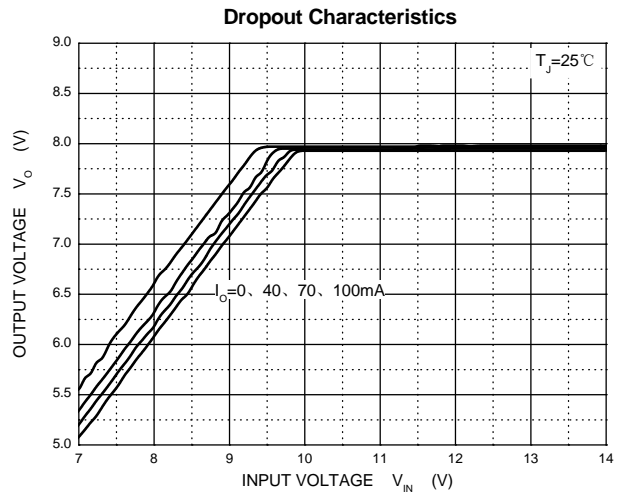
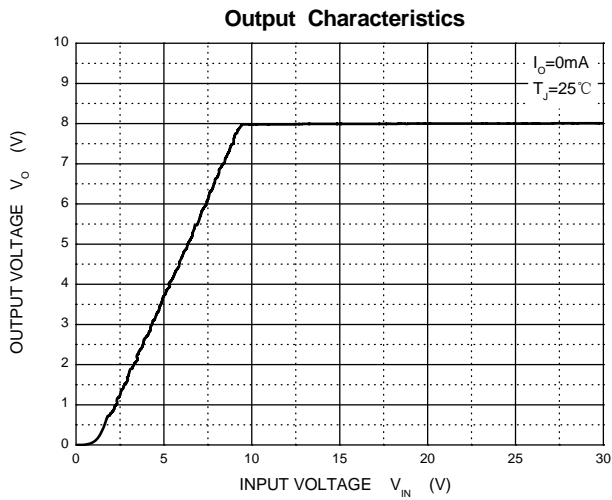

Outline Drawing

SOT-89-3L Package Outline Dimensions

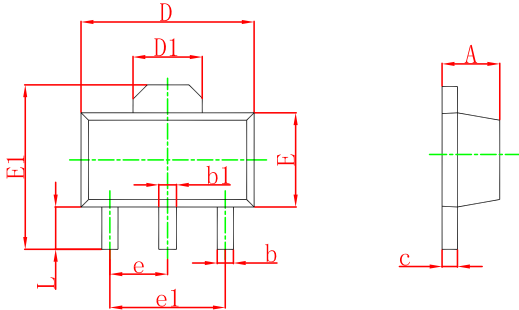

Symbol	Dimensions In Millimeters		Dimensions In Inches	
	Min	Max	Min	Max
A	1.400	1.600	0.055	0.063
b	0.320	0.520	0.013	0.020
b1	0.400	0.580	0.016	0.023
c	0.350	0.440	0.014	0.017
D	4.400	4.600	0.173	0.181
D1	1.550 REF.		0.061 REF.	
E	2.300	2.600	0.091	0.102
E1	3.940	4.250	0.155	0.167
e	1.500 TYP.		0.060 TYP.	
e1	3.000 TYP.		0.118 TYP.	
L	0.900	1.200	0.035	0.047

SOT-89-3L Suggested Pad Layout

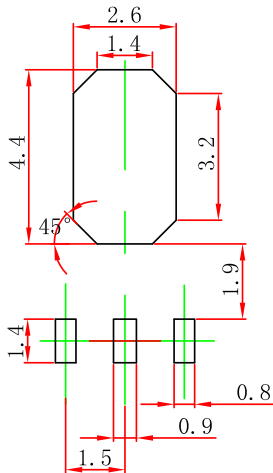

Note:

1. Controlling dimension: in/millimeters.
2. General tolerance: ±0.05mm.
3. The pad layout is for reference purposes only.

PACKAGE SPECIFICATIONS

Package	Reel Size	Reel DIA. (mm)	Q'TY/Reel (pcs)	Box Size (mm)	QTY/Box (pcs)	Carton Size (mm)	G.W.(Kg)
SOT-89-3L	7'	330	1000	203×203×195	40000	438×438×220	180000