

## Integrated Omnipolar TMR Digital Switches

### FEATURES AND BENEFITS

- Sensitivity with  $B_{OP}$  range: 9 to 70 G
- Ultra-low power consumption:  $\sim 110$  nA @  $V_{DD} = 1.8$  V and  $f_S = 2$  Hz
- Supply voltage range: 1.7 to 5.5 V
- Sensor polarity: omnipolar
- Digital CMOS outputs:
  - Push-pull
  - Open drain
- Undervoltage lockout (UVLO)
- Package options:
  - 3-lead SOT23
  - 4-lead LGA, 1.45 mm × 1.45 mm × 0.44 mm

### APPLICATIONS

- IoT devices
- Smartphones, tablets, and laptops
- Door or lid closure
- Reed switch replacement
- Tamper-proofing for utility smart meters
- Fluid level sensing/detection
- Proximity detection
- Motor controllers
- Gimbals for camera systems in drones/UAVs
- Industrial machinery/robots
- Medical devices

### DESCRIPTION

The CT813x series of omnipolar tunnel magnetoresistance (TMR) digital switches are designed for consumer and industrial applications. The devices are based on Allegro patented XtremeSense™ TMR technology with integrated CMOS process to provide a monolithic solution for superior sensing performance. The CT813x digital switches offer stable magnetic operation over the operating temperature range.

This product family has very low power consumption—as low as 110 nA—which is ideal for battery-operated products where minimal current consumption is required. The devices support magnetic fields down to 9 G for applications where there is a large air gap requirement.

For applications that require a very small form factor and low profile, the CT813x is assembled in a 4-lead LGA package. They are also available in an industry-standard 3-lead SOT-23 package to support high-volume manufacturing for industrial markets.

### PACKAGE:



*Not to scale.  
4-lead LGA package not shown.*

### FUNCTIONAL BLOCK DIAGRAMS

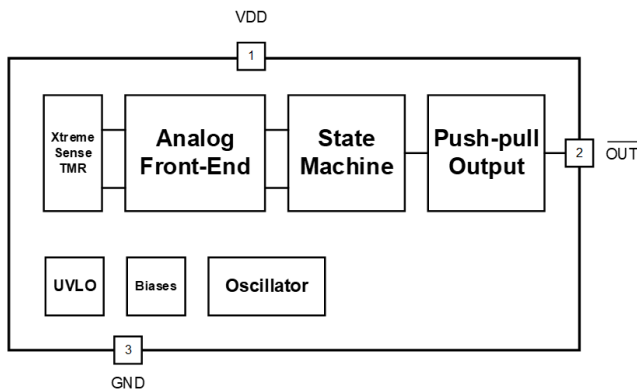

**Figure 1: CT8132 with Push-Pull Output Block Diagram for 3-Lead SOT23 Package**

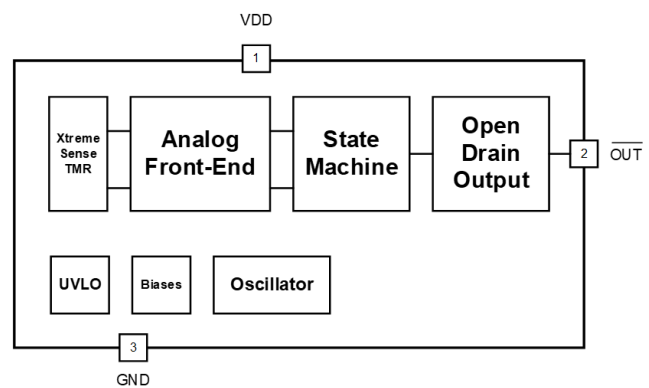

**Figure 2: CT8131 with Open Drain Output Block Diagram for 3-Lead SOT23 Package**

## Table of Contents

Features and Benefits.....	1	Electrical Characteristics.....	5
Description.....	1	Functional Description.....	22
Applications.....	1	Applications Information.....	23
Functional Block Diagrams.....	1	XtremeSense TMR Current Sensor Location.....	24
Selection Guide.....	2	Package Outline Drawings.....	25
Absolute Maximum Ratings.....	3	Tape and Reel Pocket Drawings and Dimensions.....	27
Recommended Operating Conditions.....	3	Package Information.....	29
Thermal Characteristics.....	3	Revision History.....	30
Pinout Diagrams and Terminal Lists.....	4		

## SELECTION GUIDE

Part Number	Operating Temp Range (°C)	Sensor Type	Output	B <sub>OP</sub> (G)	B <sub>RP</sub> (G)	f <sub>s</sub>	Package	Packing
CT8131BV-IL4	-40 to 85	Omnipolar	Open Drain	±30	±20	2 Hz	4-lead LGA	Tape and Reel
CT8131BV-HL4	-40 to 125							
CT8131BV-IS3	-40 to 85	Omnipolar	Open Drain	±30	±20	2 Hz	3-lead SOT23	Tape and Reel
CT8131BV-HS3	-40 to 125							
CT8132BH-IL4	-40 to 85	Omnipolar	Push-Pull	±30	±20	10 kHz	4-lead LGA	Tape and Reel
CT8132BH-HL4	-40 to 125							
CT8132BH-IS3	-40 to 85	Omnipolar	Push-Pull	±30	±20	10 kHz	3-lead SOT23	Tape and Reel
CT8132BH-HS3	-40 to 125							
CT8132BL-IS3	-40 to 85	Omnipolar	Push-Pull	±30	±20	250 Hz	3-lead SOT23	Tape and Reel
CT8132BL-HS3	-40 to 125							
CT8132BV-IL4	-40 to 85	Omnipolar	Push-Pull	±30	±20	2 Hz	4-lead LGA	Tape and Reel
CT8132BV-HL4	-40 to 125							
CT8132BV-IS3	-40 to 85	Omnipolar	Push-Pull	±30	±20	2 Hz	3-lead SOT23	Tape and Reel
CT8132BV-HS3	-40 to 125							
CT8132DM-IS3	-40 to 85	Omnipolar	Push-Pull	±15	±10	2.5 kHz	3-lead SOT23	Tape and Reel
CT8132DM-HS3	-40 to 125							
CT8132EK-IS3	-40 to 85	Omnipolar	Push-Pull	±70	±50	10 Hz	3-lead SOT23	Tape and Reel
CT8132EK-HS3	-40 to 125							
CT8132SK-IL4	-40 to 85	Omnipolar	Push-Pull	±9	±5	10 Hz	4-lead LGA	Tape and Reel
CT8132SK-HL4	-40 to 125							
CT8132SK-IS3	-40 to 85	Omnipolar	Push-Pull	±9	±5	10 Hz	3-lead SOT23	Tape and Reel
CT8132SK-HS3	-40 to 125							
CT8132SL-IS3	-40 to 85	Omnipolar	Push-Pull	±9	±5	250 Hz	3-lead SOT23	Tape and Reel
CT8132SL-HS3	-40 to 125							

## ABSOLUTE MAXIMUM RATINGS [1]

Characteristic	Symbol	Notes	Rating	Unit	
Supply Voltage	$V_{DD}$		-0.3 to 6.0	V	
Push-Pull Output (Active Low)	$V_{OUT\_PP}$		-0.3 to $V_{DD} + 0.3$ [2]	V	
Open Drain Output (Active Low)	$V_{OUT\_OD}$		-0.3 to 6.0	V	
Analog Input/Output Pins Maximum Voltage	$V_{I/O}$		-0.3 to $V_{DD} + 0.3$ [2]	V	
Input and Output Current	$I_{IN}, I_{OUT}$		$\pm 20.0$	mA	
Maximum External Magnetic Field	$B_{MAX}$	$T_A = 25^\circ\text{C}$	CT8132Sx	$\pm 600$	G
			CT813xBx, CT8132DM, CT8132EK	$\pm 2000$	G
Electrostatic Discharge Protection Level	ESD	Human Body Model (HBM) per JESD22-A114	$\pm 4.0$ (min)	kV	
		Charged Device Model (CDM) per JESD22-C101	$\pm 0.5$ (min)	kV	
Junction Temperature	$T_J$		-40 to 150	$^\circ\text{C}$	
Storage Temperature	$T_{STG}$		-65 to 155	$^\circ\text{C}$	
Lead Soldering Temperature	$T_L$	10 seconds	260	$^\circ\text{C}$	

[1] Stresses exceeding the absolute maximum ratings may damage the CT813x and may not function or be operable above the recommended operating conditions and stressing the parts to these levels is not recommended. In addition, extended exposure to stresses above the recommended operating conditions may affect device reliability. The absolute maximum ratings are stress ratings only. Allegro does not recommend exceeding or designing to absolute maximum ratings

[2] The lower of  $V_{DD} + 0.3$  V or 6.0 V.

## RECOMMENDED OPERATING CONDITIONS [1]

Characteristic	Symbol	Notes	Min.	Typ.	Max.	Unit
Supply Voltage Range	$V_{DD}$		1.7	3.3	5.5	V
Output Voltage Range	$V_{OUT}$		0	-	$V_{DD}$	V
Operating Magnetic Flux	$B_{OP}$	CT8132Sx	-	-	$\pm 450$	G
Output Current	$I_{OUT}$		-	-	$\pm 3.0$	mA
Bypass Capacitor	$C_{BYP}$		-	1.0	-	$\mu\text{F}$
Operating Ambient Temperature	$T_A$	Industrial	-40	25	85	$^\circ\text{C}$
		Extended Industrial	-40	25	125	$^\circ\text{C}$

[1] The Recommended Operating Conditions table defines the conditions for actual operation of the CT813x. Recommended operating conditions are specified to ensure optimal performance to the specifications. Allegro does not recommend exceeding them or designing to absolute maximum ratings.

## THERMAL CHARACTERISTICS

Characteristic	Symbol	Test Conditions	Value	Unit	
Junction-to-Ambient Thermal Resistance	$R_{\theta JA}$	Junction-to-ambient thermal resistance is a function of application and board layout and is determined in accordance to JEDEC standard JESD51 for a four (4) layer 2s2p FR-4 printed circuit board (PCB) with 2 oz. of copper (Cu) and 4 oz. of copper (Cu) or more for 65 A. Special attention must be paid not to exceed junction temperature $T_{J(MAX)}$ at a given ambient temperature $T_A$ .	SOT23-3	202	$^\circ\text{C/W}$
			LGA-4	165	$^\circ\text{C/W}$

## PINOUT DIAGRAMS AND TERMINAL LISTS

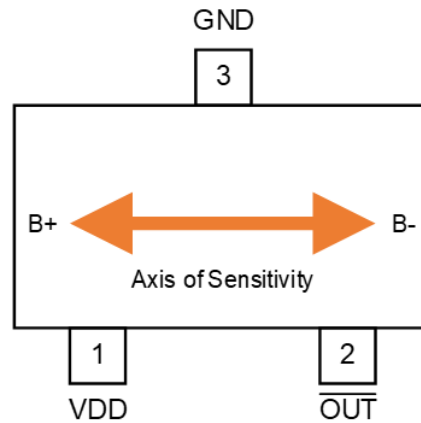

Figure 3: CT813x 3-Lead SOT23 Package for Digital Output (Top-Down View)

### Terminal List

Number	Name	Function
1	VDD	Supply Voltage
2	$\overline{\text{OUT}}$	Output Signal (Active Low)
3	GND	Ground

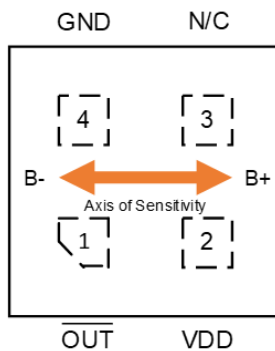

Figure 4: CT8131 4-Lead LGA Package with Digital Output (Top View)

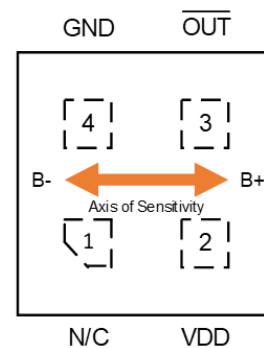

Figure 5: CT8132 4-Lead LGA Package with Digital Output (Top View)

### Terminal List

Number	CT8131	CT8132	Function
1	$\overline{\text{OUT}}$	NC	Output Signal for Open Drain (Active Low); N/C – No Connect
2	VDD	VDD	Supply Voltage
3	NC	$\overline{\text{OUT}}$	Output Signal for Push-Pull (Active Low); N/C – No Connect
4	GND	GND	Ground

**ELECTRICAL CHARACTERISTICS:** Valid for  $V_{DD} = 1.7$  to  $5.5$  V,  $C_{BYP} = 1.0$   $\mu$ F, and  $T_A = -40^\circ\text{C}$  to  $125^\circ\text{C}$ , typical values are  $V_{DD} = 3.3$  V and  $T_A = 25^\circ\text{C}$ , unless otherwise specified

Characteristics	Symbol	Test Conditions	Min.	Typ.	Max.	Unit
<b>PUSH-PULL OUTPUT</b>						
Output Voltage High $\overline{\text{OUT}}$ [1]	$V_{OH}$	$I_{OUT} = -2$ mA	$0.9 \times V_{DD}$	–	–	V
Output Voltage Low $\overline{\text{OUT}}$ [1]	$V_{OL}$	$I_{OUT} = 2$ mA	–	–	$0.1 \times V_{DD}$	V
<b>OPEN DRAIN OUTPUT</b>						
Output Voltage High [1]	$V_{OH}$		–	–	5.5	V
Output Voltage Low	$V_{OL}$	$I_{OUT} \leq 20$ mA	0	–	0.5	V
High Output Leakage Current [1]	$I_{LEAK}$	$V_{OH} = 5.5$ V, $B_{OP} = 0$	–	20	–	$\mu$ A
<b>TIMINGS</b>						
Power-On Time [1]	$t_{ON}$	$V_{DD} \geq 1.7$ V	–	50	75	$\mu$ s
Active Mode Time [1]	$t_{ACTIVE}$		–	2.6	–	$\mu$ s
<b>PROTECTION</b>						
Undervoltage Lockout [1]	$V_{UVLO}$	Rising $V_{DD}$	–	1.60	1.64	V
		Falling $V_{DD}$	1.44	1.53	–	V
UVLO Hysteresis [1]	$V_{UV\_HYS}$		–	70	–	mV

[1] Guaranteed by design and characterization; not tested in production.

## TYPICAL TIMING CHARACTERISTICS

$V_{DD} = 3.3$  V,  $T_A = 25^\circ\text{C}$ , and  $C_{BYP} = 1.0$   $\mu$ F (unless otherwise specified)

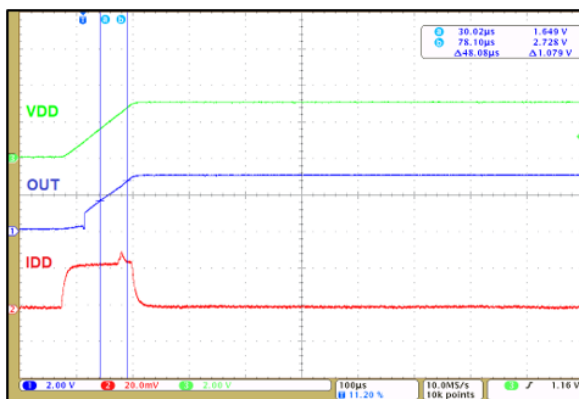

Figure 6: Power-On Time for Push-Pull Output

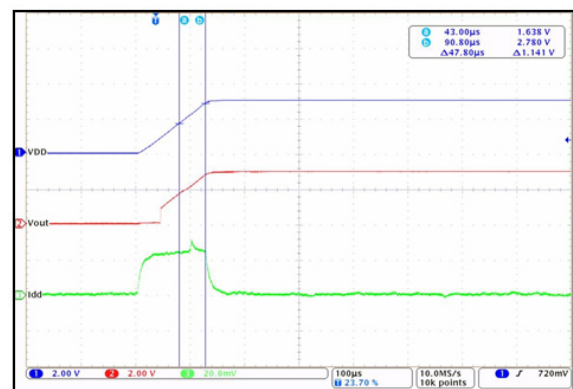

Figure 7: Power-On Time for Open Drain Output

**CT8131BV – ELECTRICAL CHARACTERISTICS and MAGNETIC SPECIFICATIONS:** Unless otherwise specified, valid for  $V_{DD} = 1.7$  to  $5.5$  V,  $C_{BYP} = 1.0$   $\mu$ F, and  $T_A = -40^\circ$ C to  $125^\circ$ C, typical values are  $V_{DD} = 3.3$  V and  $T_A = 25^\circ$ C

Characteristics	Symbol	Test Conditions	Min.	Typ.	Max.	Unit
Average Supply Current	$I_{DD(AVG)}$	$t \geq 10$ seconds	–	140	900	nA
	$I_{DD(AVG)}_{1.8V}$	$t \geq 10$ seconds, $V_{DD} = 1.8$ V	–	110	900	nA
Sampling Frequency	$f_{S1}$		1	2	4	Hz
Idle Mode Time	$t_{IDLE1}$	$f_S = 2$ Hz	250	500	1000	ms
Operate Point, B+	$B_{OPS}$		23	30	38	G
Operate Point, B–	$B_{OPN}$		–38	–30	–23	G
Release Point, B+	$B_{RPS}$		14	20	27	G
Release Point, B–	$B_{RPN}$		–27	–20	–14	G
Hysteresis	$B_{HYST}$		5	10	–	G

**CT8132BH – ELECTRICAL CHARACTERISTICS and MAGNETIC SPECIFICATIONS:** Unless otherwise specified, valid for  $V_{DD} = 1.7$  to  $5.5$  V,  $C_{BYP} = 1.0$   $\mu$ F, and  $T_A = -40^\circ$ C to  $125^\circ$ C, typical values are  $V_{DD} = 3.3$  V and  $T_A = 25^\circ$ C

Characteristics	Symbol	Test Conditions	Min.	Typ.	Max.	Unit
Average Supply Current	$I_{DD(AVG)}$	$t \geq 10$ seconds	–	45	57	$\mu$ A
	$I_{DD(AVG)}_{1.8V}$	$t \geq 10$ seconds, $V_{DD} = 1.8$ V	–	41	47	$\mu$ A
Sampling Frequency	$f_S$		6	10	14	kHz
Idle Mode Time	$t_{IDLE}$	$f_S = 10$ kHz	71	100	167	$\mu$ s
Operate Point, B+	$B_{OPS}$		23	30	38	G
Operate Point, B–	$B_{OPN}$		–38	–30	–23	G
Release Point, B+	$B_{RPS}$		14	20	27	G
Release Point, B–	$B_{RPN}$		–27	–20	–14	G
Hysteresis	$B_{HYST}$		5	10	–	G

**CT8132BL – ELECTRICAL CHARACTERISTICS and MAGNETIC SPECIFICATIONS:** Unless otherwise specified, valid for  $V_{DD} = 1.7$  to  $5.5$  V,  $C_{BYP} = 1.0$   $\mu$ F, and  $T_A = -40^\circ\text{C}$  to  $125^\circ\text{C}$ , typical values are  $V_{DD} = 3.3$  V and  $T_A = 25^\circ\text{C}$

Characteristics	Symbol	Test Conditions	Min.	Typ.	Max.	Unit
Average Supply Current	$I_{DD(AVG)}$	$t \geq 10$ seconds	–	1.3	3.0	$\mu$ A
	$I_{DD(AVG)}_{1.8V}$	$t \geq 10$ seconds, $V_{DD} = 1.8$ V	–	1.1	2.0	$\mu$ A
Sampling Frequency	$f_S$		150	250	350	Hz
Idle Mode Time	$t_{IDLE}$	$f_S = 250$ Hz	2.8	4.0	6.7	ms
Operate Point, B+	$B_{OPS}$		23	30	38	G
Operate Point, B–	$B_{OPN}$		–38	–30	–23	G
Release Point, B+	$B_{RPS}$		14	20	27	G
Release Point, B–	$B_{RPN}$		–27	–20	–14	G
Hysteresis	$B_{HYST}$		5	10	–	G

**CT8132BV – ELECTRICAL CHARACTERISTICS and MAGNETIC SPECIFICATIONS:** Unless otherwise specified, valid for  $V_{DD} = 1.7$  to  $5.5$  V,  $C_{BYP} = 1.0$   $\mu$ F, and  $T_A = -40^\circ\text{C}$  to  $125^\circ\text{C}$ , typical values are  $V_{DD} = 3.3$  V and  $T_A = 25^\circ\text{C}$

Characteristics	Symbol	Test Conditions	Min.	Typ.	Max.	Unit
Average Supply Current	$I_{DD(AVG)}$	$t \geq 10$ seconds	–	140	900	nA
	$I_{DD(AVG)}_{1.8V}$	$t \geq 10$ seconds, $V_{DD} = 1.8$ V	–	110	700	nA
Sampling Frequency	$f_S$		1	2	4	Hz
Idle Mode Time	$t_{IDLE}$	$f_S = 2$ Hz	250	500	1000	ms
Operate Point, B+	$B_{OPS}$		23	30	38	G
Operate Point, B–	$B_{OPN}$		–38	–30	–23	G
Release Point, B+	$B_{RPS}$		14	20	27	G
Release Point, B–	$B_{RPN}$		–27	–20	–14	G
Hysteresis	$B_{HYST}$		5	10	–	G

TYPICAL MAGNETIC CHARACTERISTICS FOR CT813xBV, CT8132BH AND CT8132BL

$V_{DD} = 3.3\text{ V}$ ,  $T_A = 25^\circ\text{C}$ , and  $C_{BYP} = 1.0\ \mu\text{F}$  (unless otherwise specified)

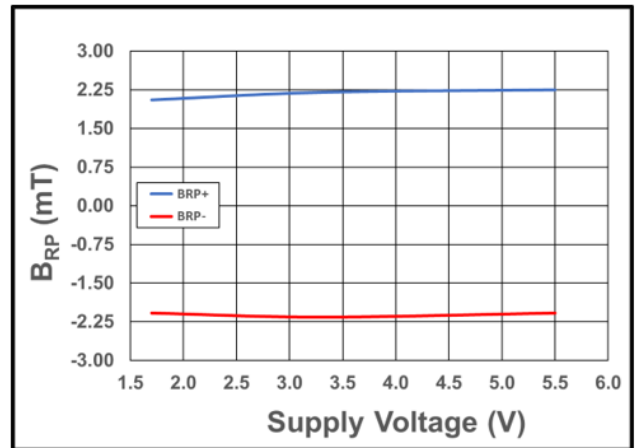
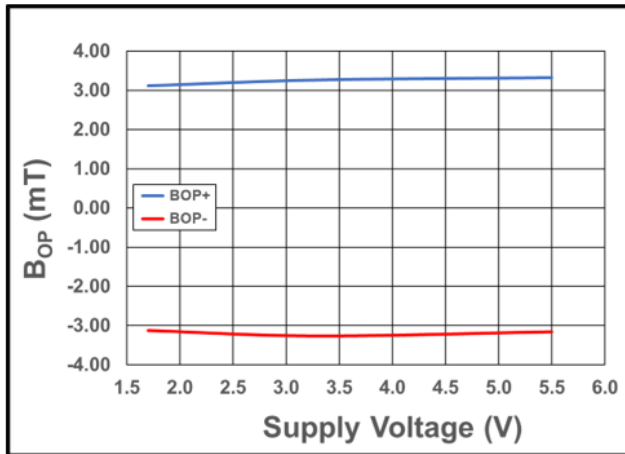

Figure 8:  $B_{OP-}$  (Red) and  $B_{OP+}$  (Blue) vs. Supply Voltage at  $T_A = 25^\circ\text{C}$

Figure 9:  $B_{RP-}$  (Red) and  $B_{RP+}$  (Blue) vs. Supply Voltage at  $T_A = 25^\circ\text{C}$

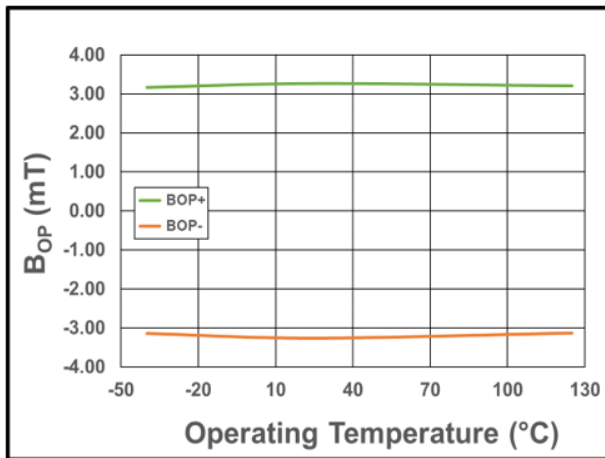

Figure 10:  $B_{OP-}$  (Orange) and  $B_{OP+}$  (Green) vs. Temperature at  $V_{DD} = 3.3\text{ V}$

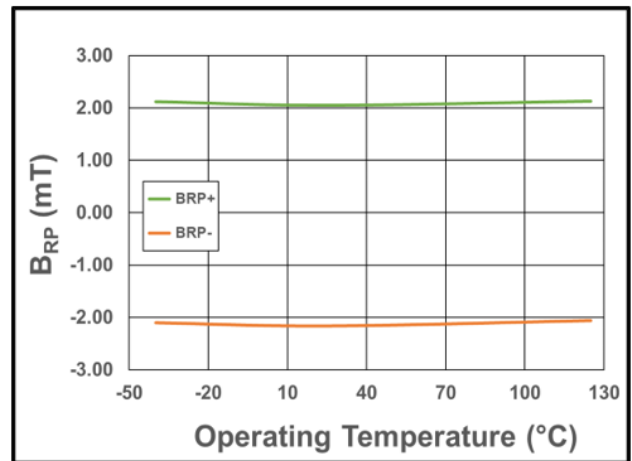

Figure 11:  $B_{RP-}$  (Orange) and  $B_{RP+}$  (Green) vs. Temperature at  $V_{DD} = 3.3\text{ V}$



**TYPICAL ELECTRICAL CHARACTERISTICS FOR CT813xBV**

$V_{DD} = 3.3\text{ V}$ ,  $T_A = 25^\circ\text{C}$ , and  $C_{BYP} = 1.0\ \mu\text{F}$  (unless otherwise specified)

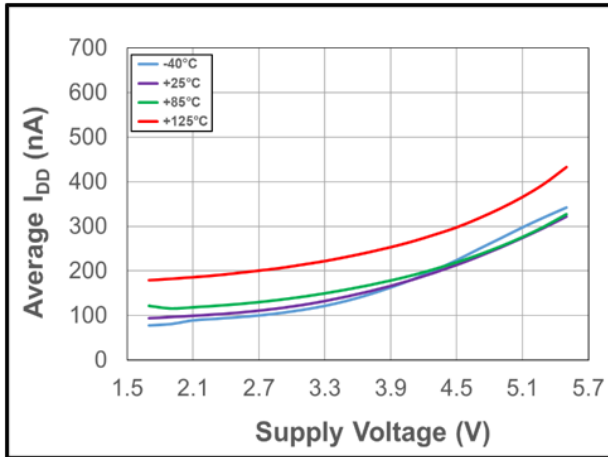

Figure 12: Average Supply Current vs. Supply Voltage vs. Temperature

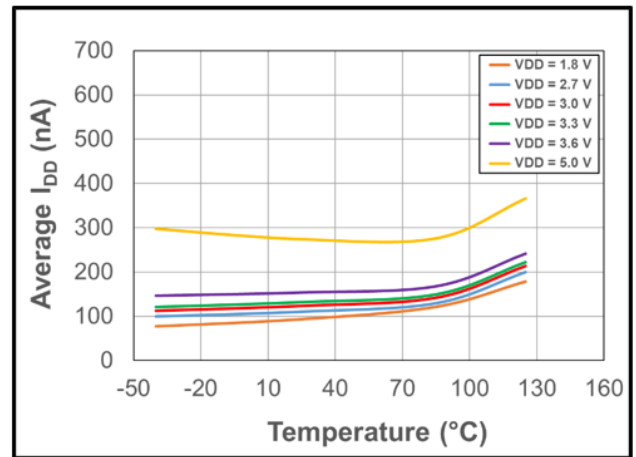

Figure 13: Average Supply Current vs. Temperature vs. Supply Voltage

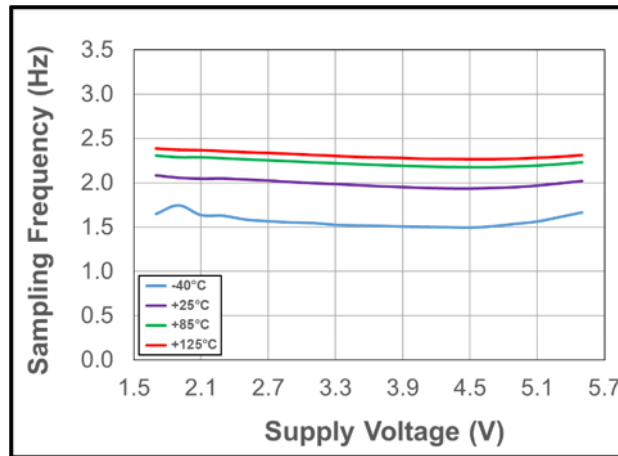

Figure 14: Sampling Frequency vs. Supply Voltage vs. Temperature

**TYPICAL ELECTRICAL CHARACTERISTICS FOR CT8132BH**

$V_{DD} = 3.3\text{ V}$ ,  $T_A = 25^\circ\text{C}$ , and  $C_{BYP} = 1.0\ \mu\text{F}$  (unless otherwise specified)

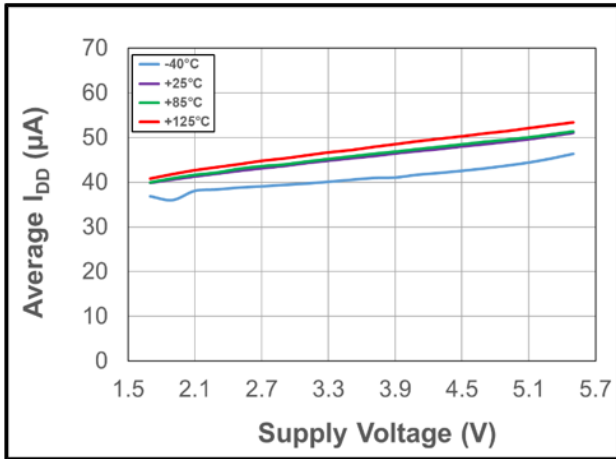

Figure 15: Average Supply Current vs. Supply Voltage vs. Temperature

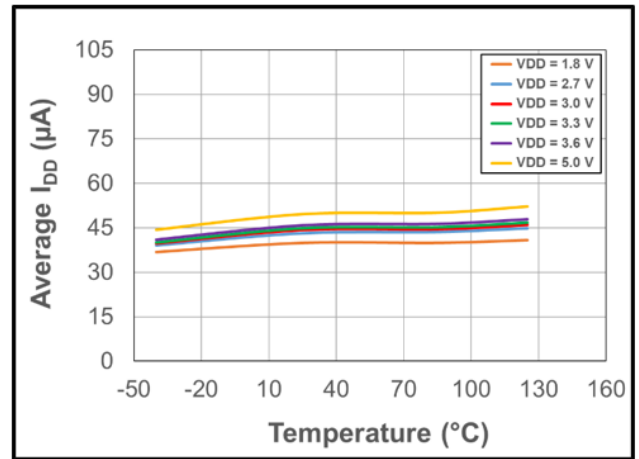

Figure 16: Average Supply Current vs. Temperature vs. Supply Voltage

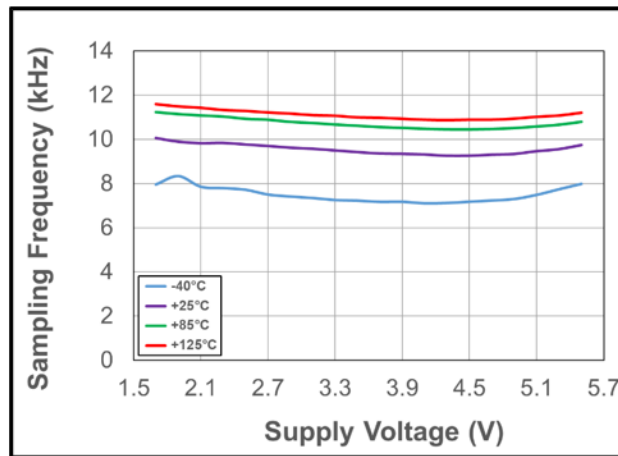

Figure 17: Sampling Frequency vs. Supply Voltage vs. Temperature

**TYPICAL ELECTRICAL CHARACTERISTICS FOR CT8132BL**

$V_{DD} = 3.3\text{ V}$ ,  $T_A = 25^\circ\text{C}$ , and  $C_{BYP} = 1.0\ \mu\text{F}$  (unless otherwise specified)

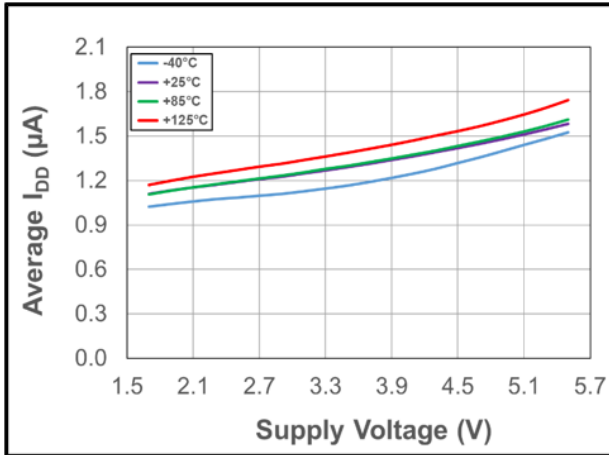

Figure 18: Average Supply Current vs. Supply Voltage vs. Temperature

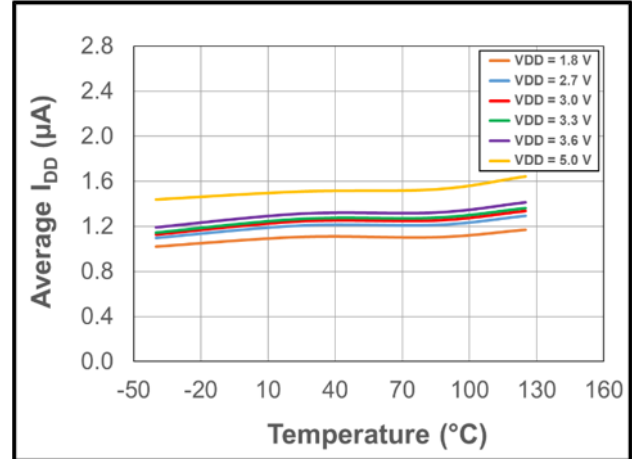

Figure 19: Average Supply Current vs. Temperature vs. Supply Voltage

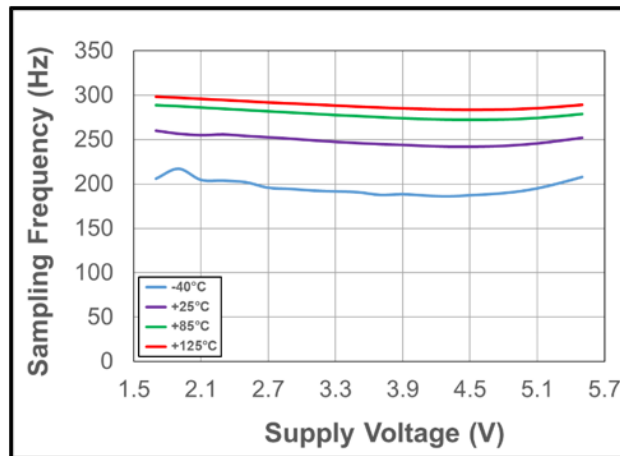

Figure 20: Sampling Frequency vs. Supply Voltage vs. Temperature

**CT8132DM – ELECTRICAL CHARACTERISTICS and MAGNETIC SPECIFICATIONS:** Unless otherwise specified, valid for  $V_{DD} = 1.7$  to  $5.5$  V,  $C_{BYP} = 1.0$   $\mu$ F, and  $T_A = -40^\circ\text{C}$  to  $125^\circ\text{C}$ , typical values are  $V_{DD} = 3.3$  V and  $T_A = 25^\circ\text{C}$

Characteristics	Symbol	Test Conditions	Min.	Typ.	Max.	Unit
Average Supply Current	$I_{DD(AVG)}$	$t \geq 10$ seconds	–	11.5	15.0	$\mu$ A
	$I_{DD(AVG)}_{1.8V}$	$t \geq 10$ seconds, $V_{DD} = 1.8$ V	–	10.5	12.0	$\mu$ A
Sampling Frequency	$f_S$		1.5	2.5	3.5	kHz
Idle Mode Time	$t_{IDLE}$	$f_S = 2.5$ kHz	285	400	667	$\mu$ s
Operate Point, B+	$B_{OPS}$		11	15	19	G
Operate Point, B–	$B_{OPN}$		–19	–15	–11	G
Release Point, B+	$B_{RPS}$		6	10	14	G
Release Point, B–	$B_{RPN}$		–14	–10	–6	G
Hysteresis	$B_{HYST}$		3	5	–	G

**TYPICAL MAGNETIC CHARACTERISTICS FOR CT8132DM**

$V_{DD} = 3.3\text{ V}$ ,  $T_A = 25^\circ\text{C}$ , and  $C_{BYP} = 1.0\ \mu\text{F}$  (unless otherwise specified)

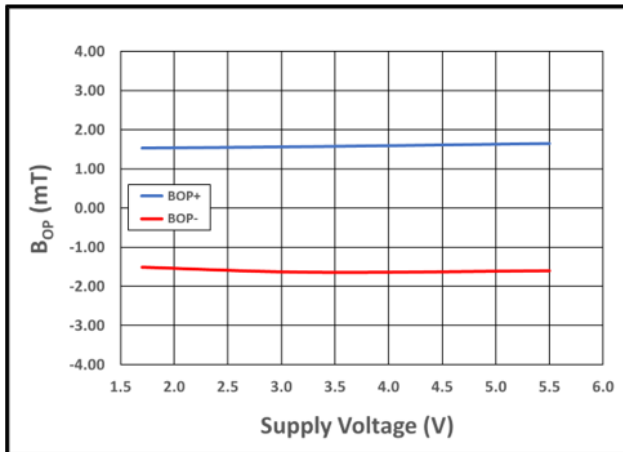

Figure 21:  $B_{OP-}$  (Red) and  $B_{OP+}$  (Blue) vs. Supply Voltage at  $T_A = 25^\circ\text{C}$

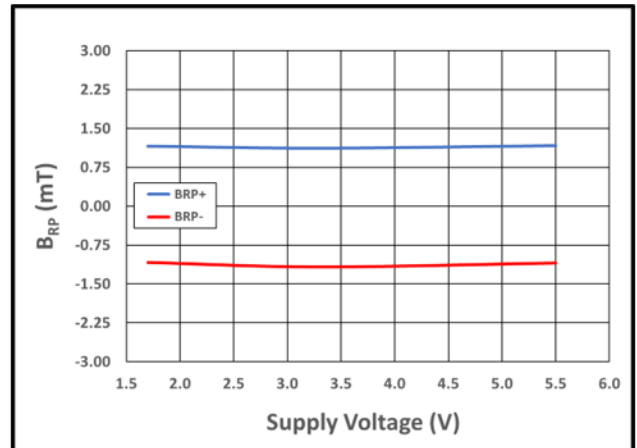

Figure 22:  $B_{RP-}$  (Red) and  $B_{RP+}$  (Blue) vs. Supply Voltage at  $T_A = 25^\circ\text{C}$

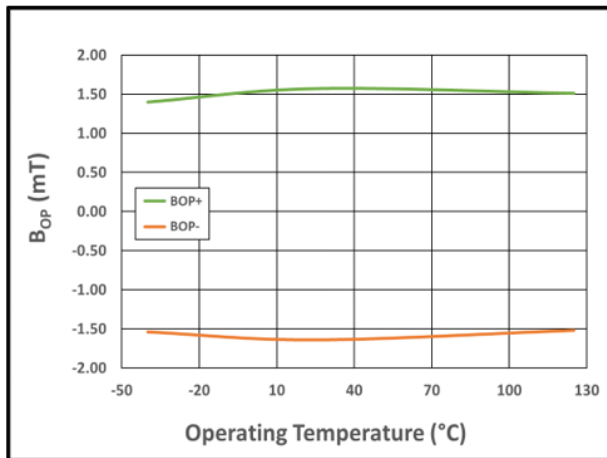

Figure 23:  $B_{OP-}$  (Orange) and  $B_{OP+}$  (Green) vs. Temperature at  $V_{DD} = 3.3\text{ V}$

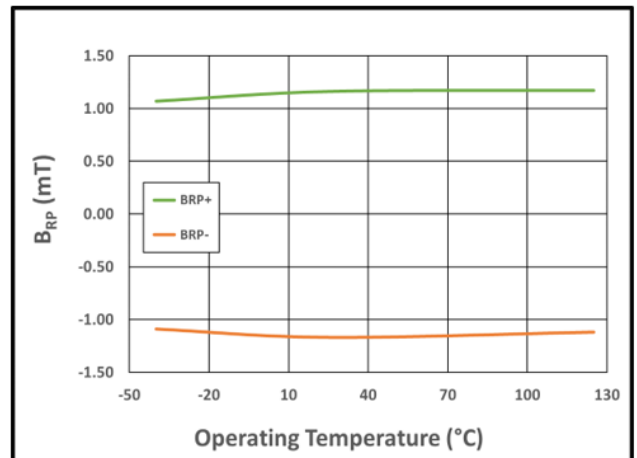

Figure 24:  $B_{RP-}$  (Orange) and  $B_{RP+}$  (Green) vs. Temperature at  $V_{DD} = 3.3\text{ V}$

**TYPICAL ELECTRICAL CHARACTERISTICS FOR CT8132DM**

$V_{DD} = 3.3\text{ V}$ ,  $T_A = 25^\circ\text{C}$ , and  $C_{BYP} = 1.0\ \mu\text{F}$  (unless otherwise specified)

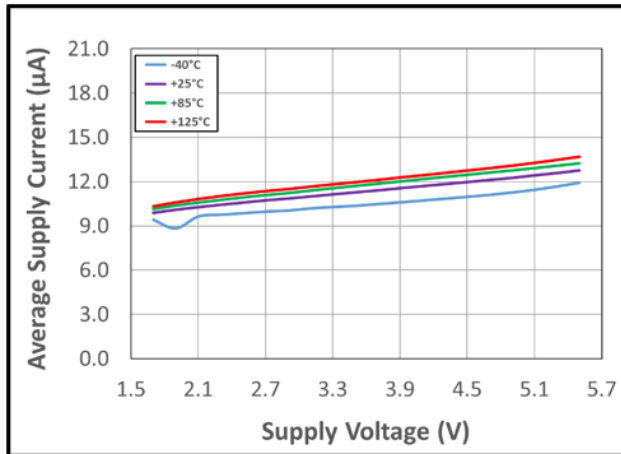

Figure 25: Average Supply Current vs. Supply Voltage vs. Temperature

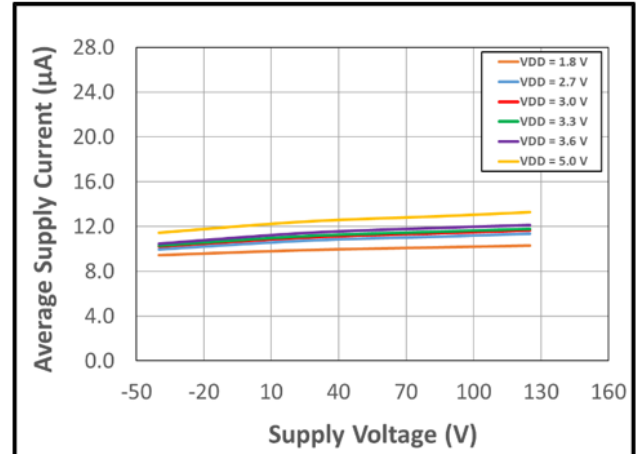

Figure 26: Average Supply Current vs. Temperature vs. Supply Voltage

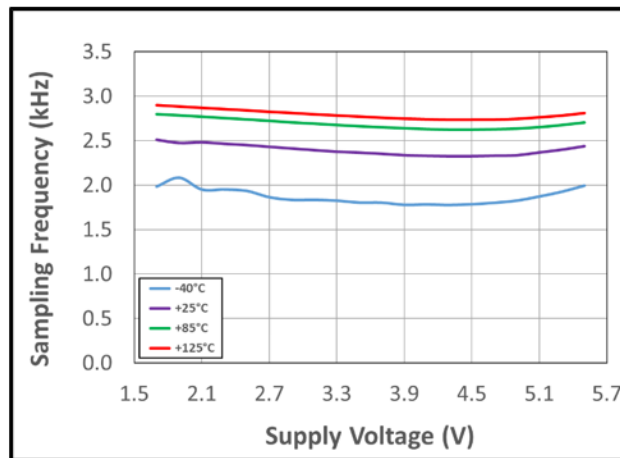

Figure 27: Sampling Frequency vs. Supply Voltage vs. Temperature

**CT8132EK – ELECTRICAL CHARACTERISTICS and MAGNETIC SPECIFICATIONS:** Unless otherwise specified, valid for  $V_{DD} = 1.7$  to  $5.5$  V,  $C_{BYP} = 1.0$   $\mu$ F, and  $T_A = -40^\circ$ C to  $125^\circ$ C, typical values are  $V_{DD} = 3.3$  V and  $T_A = 25^\circ$ C

Characteristics	Symbol	Test Conditions	Min.	Typ.	Max.	Unit
Average Supply Current	$I_{DD(AVG)}$	$t \geq 10$ seconds	–	190	900	nA
	$I_{DD(AVG)}_{1.8V}$	$t \geq 10$ seconds, $V_{DD} = 1.8$ V	–	145	700	nA
Sampling Frequency	$f_S$		6	10	14	Hz
Idle Mode Time	$t_{IDLE}$	$f_S = 10$ Hz	71	100	166	ms
Operate Point, B+	$B_{OPS}$		62	70	78	G
Operate Point, B–	$B_{OPN}$		–78	–70	–62	G
Release Point, B+	$B_{RPS}$		42	50	60	G
Release Point, B–	$B_{RPN}$		–60	–50	–42	G
Hysteresis	$B_{HYST}$		12	20	–	G

TYPICAL MAGNETIC CHARACTERISTICS FOR CT8132EK

$V_{DD} = 3.3\text{ V}$ ,  $T_A = 25^\circ\text{C}$ , and  $C_{BYP} = 1.0\ \mu\text{F}$  (unless otherwise specified)

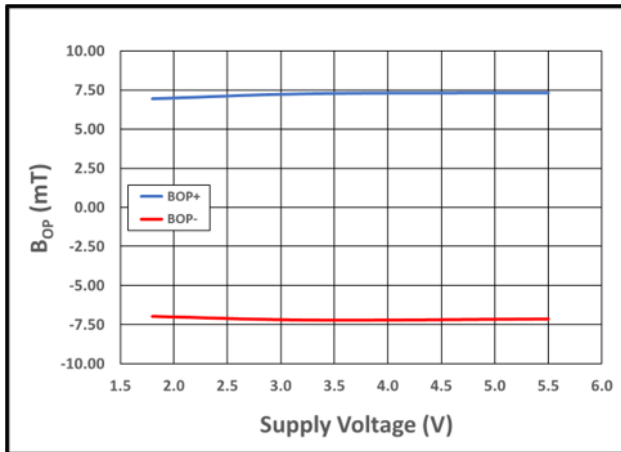

Figure 28:  $B_{OP-}$  (Red) and  $B_{OP+}$  (Blue) vs. Supply Voltage at  $T_A = 25^\circ\text{C}$

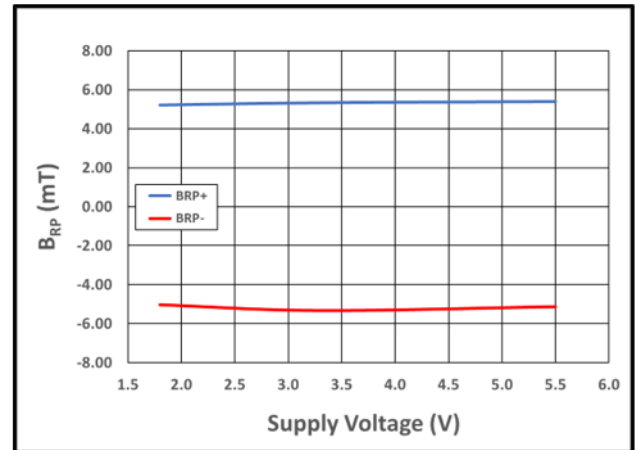

Figure 29:  $B_{RP-}$  (Red) and  $B_{RP+}$  (Blue) vs. Supply Voltage at  $T_A = 25^\circ\text{C}$

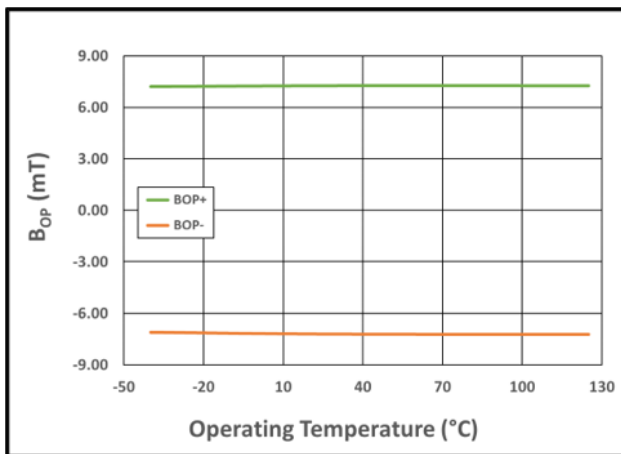

Figure 30:  $B_{OP-}$  (Orange) and  $B_{OP+}$  (Green) vs. Temperature at  $V_{DD} = 3.3\text{ V}$

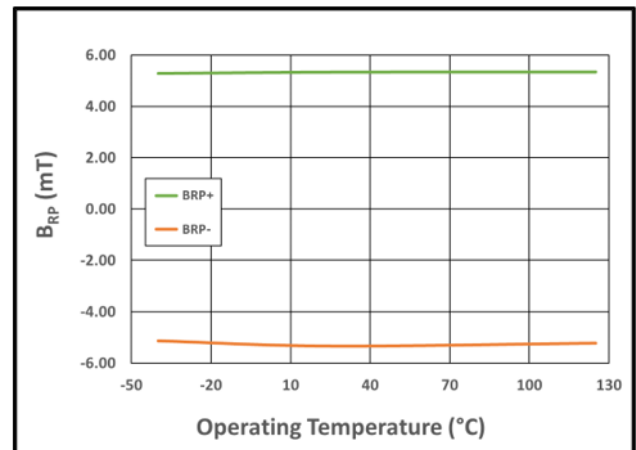

Figure 31:  $B_{RP-}$  (Orange) and  $B_{RP+}$  (Green) vs. Temperature at  $V_{DD} = 3.3\text{ V}$



**TYPICAL ELECTRICAL CHARACTERISTICS FOR CT8132EK**

$V_{DD} = 3.3\text{ V}$ ,  $T_A = 25^\circ\text{C}$ , and  $C_{BYP} = 1.0\ \mu\text{F}$  (unless otherwise specified)

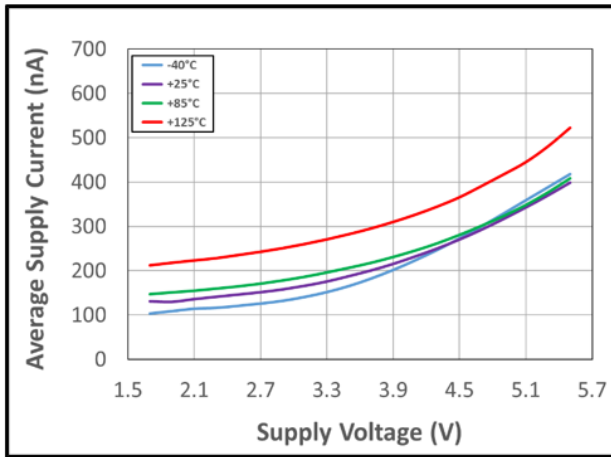

Figure 32: Average Supply Current vs. Supply Voltage vs. Temperature

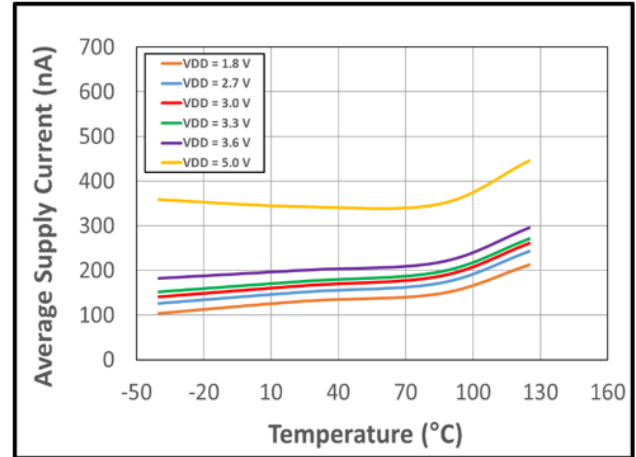

Figure 33: Average Supply Current vs. Temperature vs. Supply Voltage

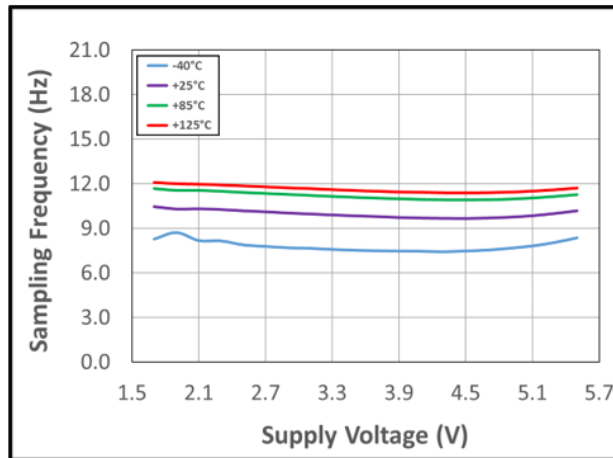

Figure 34: Sampling Frequency vs. Supply Voltage vs. Temperature

**CT8132SK – ELECTRICAL CHARACTERISTICS and MAGNETIC SPECIFICATIONS:** Unless otherwise specified, valid for  $V_{DD} = 1.7$  to  $5.5$  V,  $C_{BYP} = 1.0$   $\mu$ F, and  $T_A = -40^\circ\text{C}$  to  $125^\circ\text{C}$ , typical values are  $V_{DD} = 3.3$  V and  $T_A = 25^\circ\text{C}$

Characteristics	Symbol	Test Conditions	Min.	Typ.	Max.	Unit
Average Supply Current	$I_{DD(AVG)}$	$t \geq 10$ seconds	–	190	900	nA
	$I_{DD(AVG)}_{1.8V}$	$t \geq 10$ seconds, $V_{DD} = 1.8$ V	–	145	700	nA
Sampling Frequency	$f_S$		6	10	14	Hz
Idle Mode Time	$t_{IDLE}$	$f_S = 10$ Hz	71	100	166	ms
Operate Point, B+	$B_{OPS}$		7	9	12	G
Operate Point, B–	$B_{OPN}$		–12	–9	–7	G
Release Point, B+	$B_{RPS}$		3	5	7	G
Release Point, B–	$B_{RPN}$		–7	–5	–3	G
Hysteresis	$B_{HYST}$		3	4	–	G

**CT8132SL – ELECTRICAL CHARACTERISTICS and MAGNETIC SPECIFICATIONS:** Unless otherwise specified, valid for  $V_{DD} = 1.7$  to  $5.5$  V,  $C_{BYP} = 1.0$   $\mu$ F, and  $T_A = -40^\circ\text{C}$  to  $125^\circ\text{C}$ , typical values are  $V_{DD} = 3.3$  V and  $T_A = 25^\circ\text{C}$

Characteristics	Symbol	Test Conditions	Min.	Typ.	Max.	Unit
Average Supply Current	$I_{DD(AVG)}$	$t \geq 10$ seconds	–	1.3	3.0	$\mu$ A
	$I_{DD(AVG)}_{1.8V}$	$t \geq 10$ seconds, $V_{DD} = 1.8$ V	–	1.1	2.0	$\mu$ A
Sampling Frequency	$f_S$		150	250	350	Hz
Idle Mode Time	$t_{IDLE}$	$f_S = 250$ Hz	2.8	4.0	6.7	ms
Operate Point, B+	$B_{OPS}$		7	9	12	G
Operate Point, B–	$B_{OPN}$		–12	–9	–7	G
Release Point, B+	$B_{RPS}$		3	5	7	G
Release Point, B–	$B_{RPN}$		–7	–5	–3	G
Hysteresis	$B_{HYST}$		3	4	–	G

TYPICAL MAGNETIC CHARACTERISTICS FOR CT8132SK AND CT8132SL

$V_{DD} = 3.3\text{ V}$ ,  $T_A = 25^\circ\text{C}$ , and  $C_{BYP} = 1.0\ \mu\text{F}$  (unless otherwise specified)

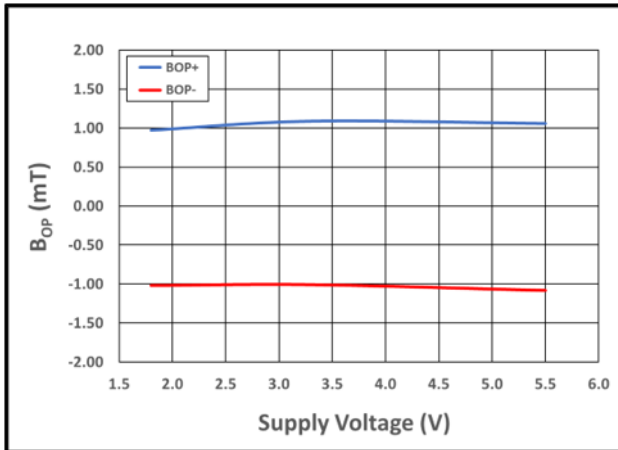

Figure 35:  $B_{OP-}$  (Red) and  $B_{OP+}$  (Blue) vs. Supply Voltage at  $T_A = 25^\circ\text{C}$

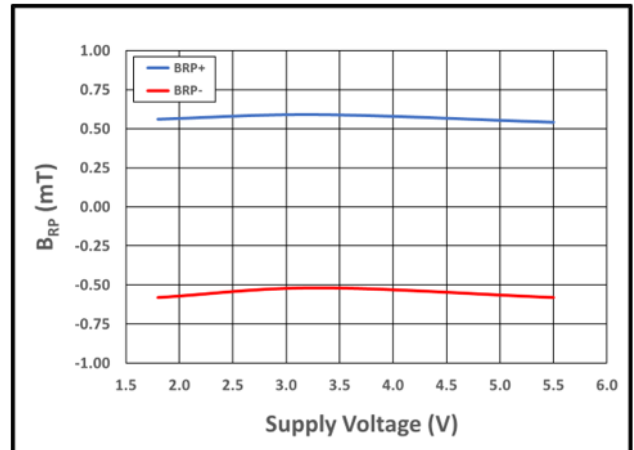

Figure 36:  $B_{RP-}$  (Red) and  $B_{RP+}$  (Blue) vs. Supply Voltage at  $T_A = 25^\circ\text{C}$

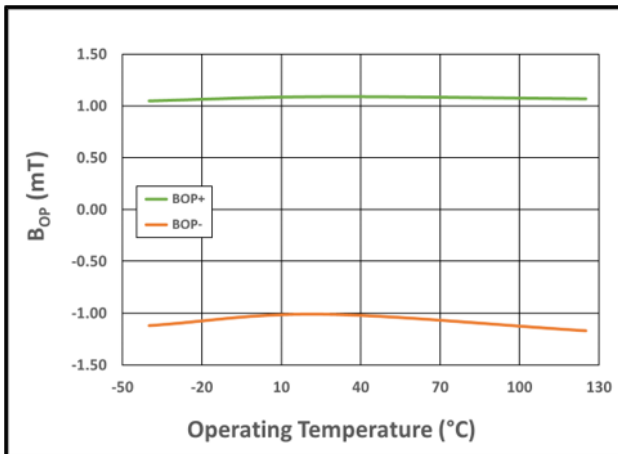

Figure 37:  $B_{OP-}$  (Orange) and  $B_{OP+}$  (Green) vs. Temperature at  $V_{DD} = 3.3\text{ V}$

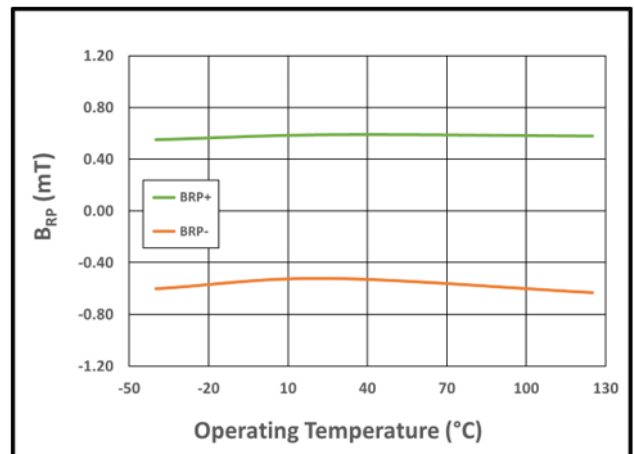

Figure 38:  $B_{RP-}$  (Orange) and  $B_{RP+}$  (Green) vs. Temperature at  $V_{DD} = 3.3\text{ V}$

**TYPICAL ELECTRICAL CHARACTERISTICS FOR CT8132SK**

$V_{DD} = 3.3\text{ V}$ ,  $T_A = 25^\circ\text{C}$ , and  $C_{BYP} = 1.0\ \mu\text{F}$  (unless otherwise specified)

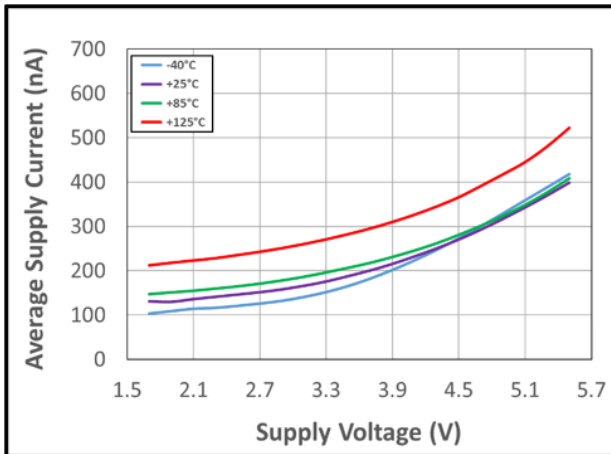

Figure 39: Average Supply Current vs. Supply Voltage vs. Temperature

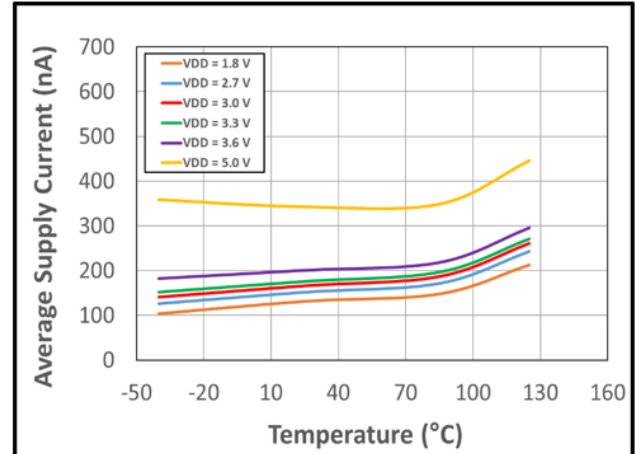

Figure 40: Average Supply Current vs. Temperature vs. Supply Voltage

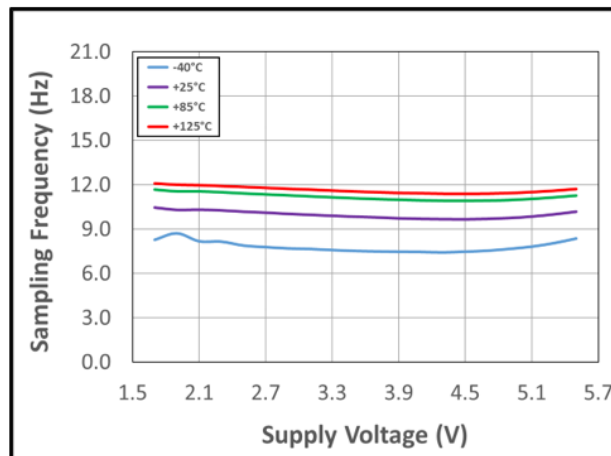

Figure 41: Sampling Frequency vs. Supply Voltage vs. Temperature

TYPICAL ELECTRICAL CHARACTERISTICS FOR CT8132SL

$V_{DD} = 3.3\text{ V}$ ,  $T_A = 25^\circ\text{C}$ , and  $C_{BYP} = 1.0\ \mu\text{F}$  (unless otherwise specified)

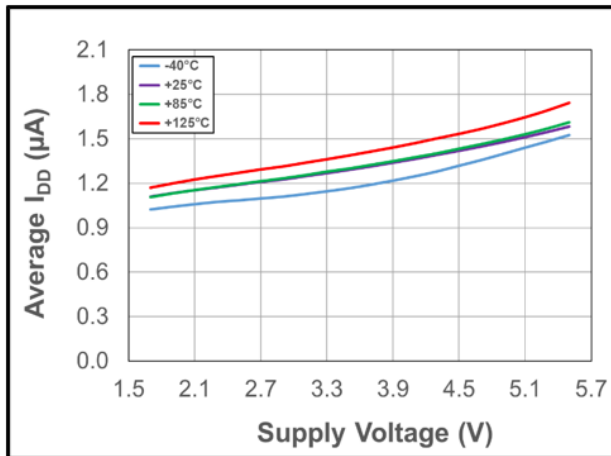

Figure 42: Average Supply Current vs. Supply Voltage vs. Temperature

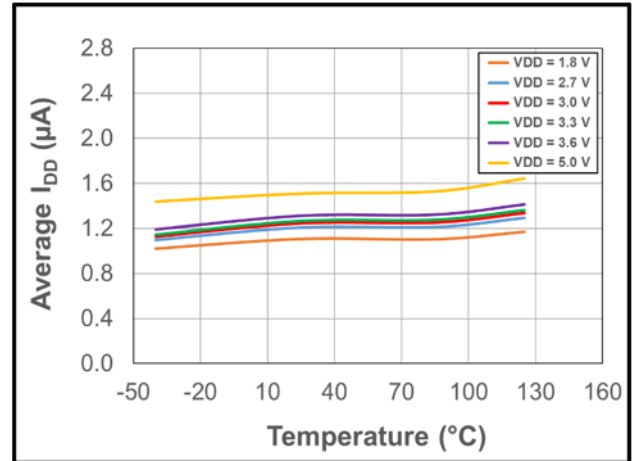

Figure 43: Average Supply Current vs. Temperature vs. Supply Voltage

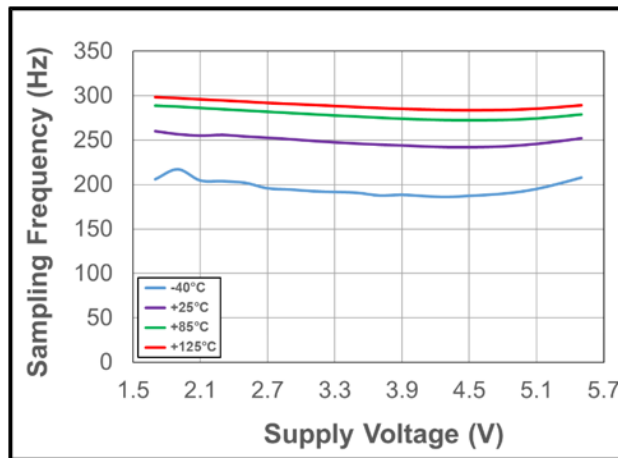

Figure 44: Sampling Frequency vs. Supply Voltage vs. Temperature

## FUNCTIONAL DESCRIPTION

### Overview

The CT813x is a product family of omnipolar TMR magnetic switches that supports a wide operating voltage range of 1.7 to 5.5 V and is capable of providing two digital output configurations: open drain or push-pull. These omnipolar TMR digital switches are designed to consume a minimal amount of current which is ideal for battery-operated products. It also supports a wide range of sensitivity levels for various applications.

### Undervoltage Lockout (UVLO)

The Undervoltage Lockout protection circuitry of the CT813x is activated when the supply voltage ( $V_{DD}$ ) falls below 1.53 V. The CT813x remains in a low quiescent state and the  $\overline{OUT}$  output is not valid until  $V_{DD}$  rises above the UVLO threshold (1.60 V).

### Power-On Time ( $t_{ON}$ )

The Power-On Time ( $t_{ON}$ ) of 50  $\mu s$  is the amount of time required by the CT813x to start up, power-on, and acquire the first sample. The chip is fully powered up and operational from the moment the supply voltage passes the rising UVLO point (1.60 V). This time includes the ramp-up time and the settling time (within 10% of steady-state voltage under an applied magnetic field) after the power supply have reach the minimum  $V_{DD}$ .

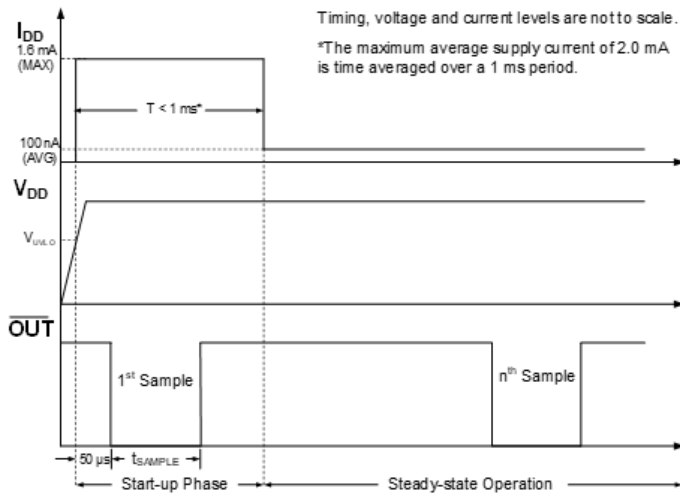

Figure 45: CT813x Power-On Timing Diagram

### Omnipolar Magnetic Flux

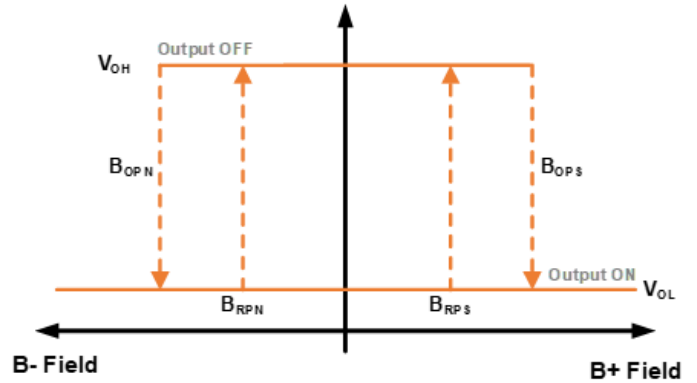

Figure 46: CT813x Response Time Curve

Table 1: CT8131 Open Drain Output Behavior

Magnetic Field	Condition	Output
Positive Field	$B > B_{OPS}$	Low (ON)
	$0 < B < B_{RPS}$	High-Z (OFF)
Negative Field	$B < B_{OPN}$	Low (ON)
	$0 > B > B_{RPN}$	High-Z (OFF)

Table 2: CT8132 Push-Pull Output Behavior

Magnetic Field	Condition	Output
Positive Field	$B > B_{OPS}$	Low (ON)
	$0 < B < B_{RPS}$	High (OFF)
Negative Field	$B < B_{OPN}$	Low (ON)
	$0 > B > B_{RPN}$	High (OFF)

## APPLICATIONS INFORMATION

A decoupling capacitor,  $C_{BYP}$ , between the supply voltage (VDD) and ground (GND) is required to lower the noise going into the CT8131 as well as providing isolation from the other circuits. The decoupling capacitor should be placed close to the TMR digital switch. A typical capacitor value of 1.0  $\mu\text{F}$  (ceramic) will be sufficient. A pull-up resistor of 47 k $\Omega$  connected from OUT to the system voltage ( $V_{SYS}$ ) is required for the CT8131.

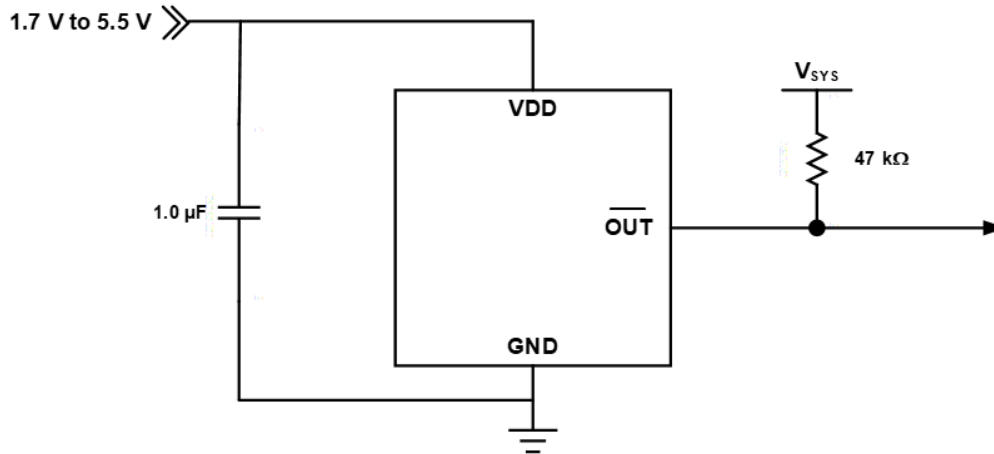

Figure 47: CT8131 Application Block Diagram

Like the CT8131, the CT8132 products require a 1.0  $\mu\text{F}$  (ceramic) bypass capacitor to be connected between the supply voltage and ground.

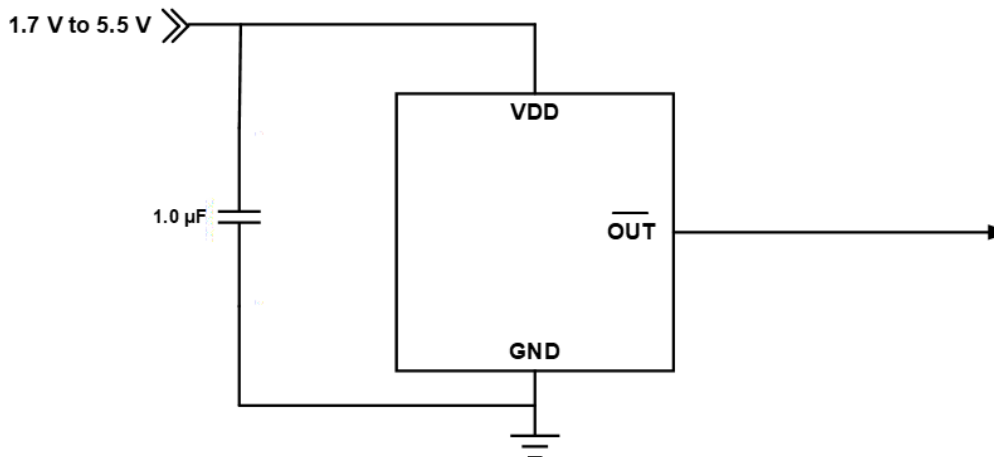

Figure 48: CT8132 Application Block Diagram

## XtremeSense TMR Current Sensor Location

The XtremeSense TMR sensor location for the CT813x products are shown in Figure 49 and Figure 50. The dimensions shown in both figures are typical values.

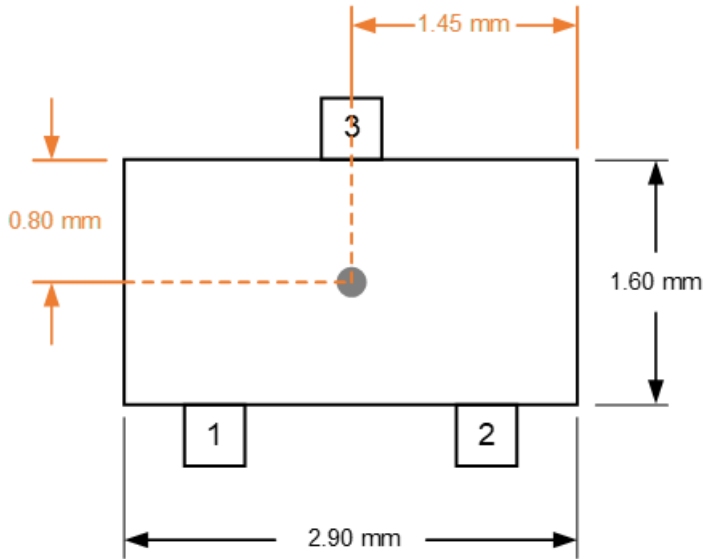

Figure 49: XtremeSense TMR Sensor Location for CT813x products in 3-lead SOT23 Package

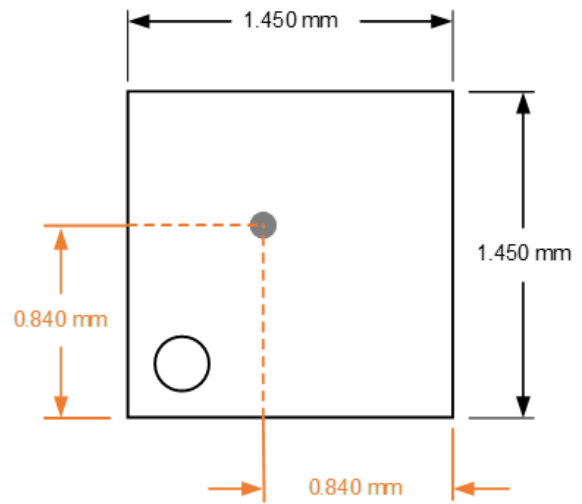

Figure 50: XtremeSense TMR Sensor Location for CT813x products in 4-lead LGA Package



PACKAGE OUTLINE DRAWINGS

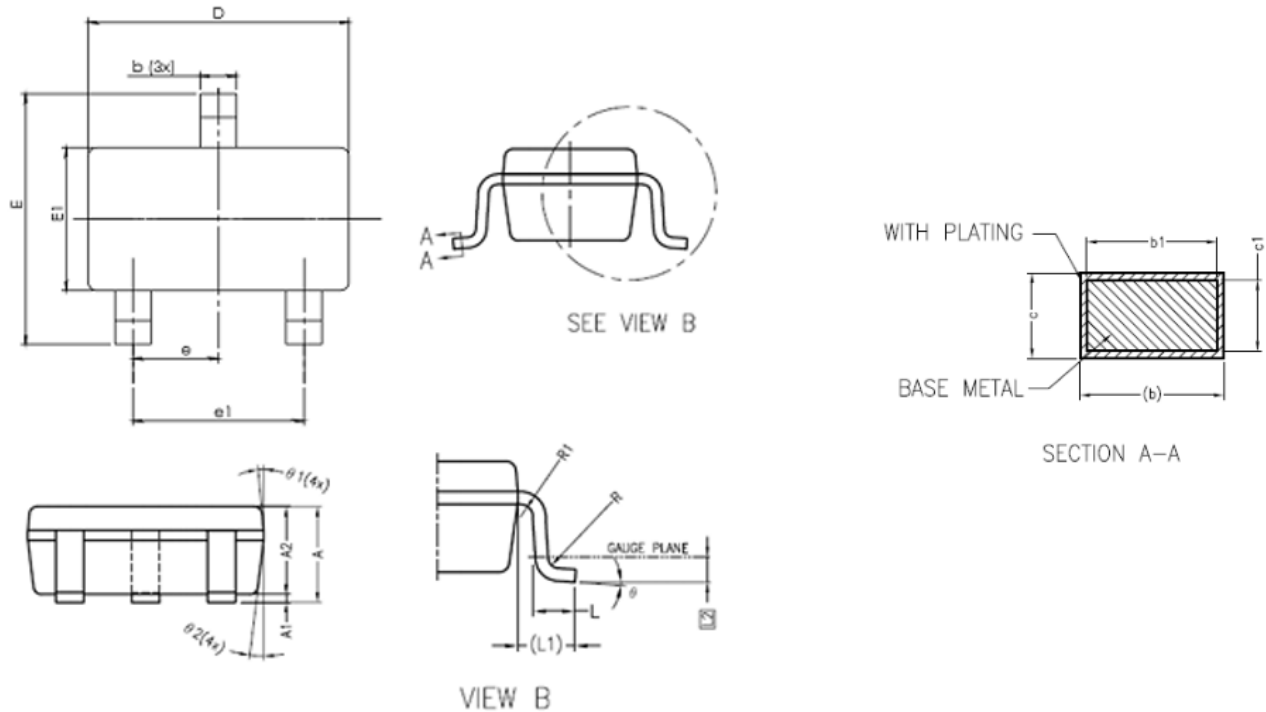
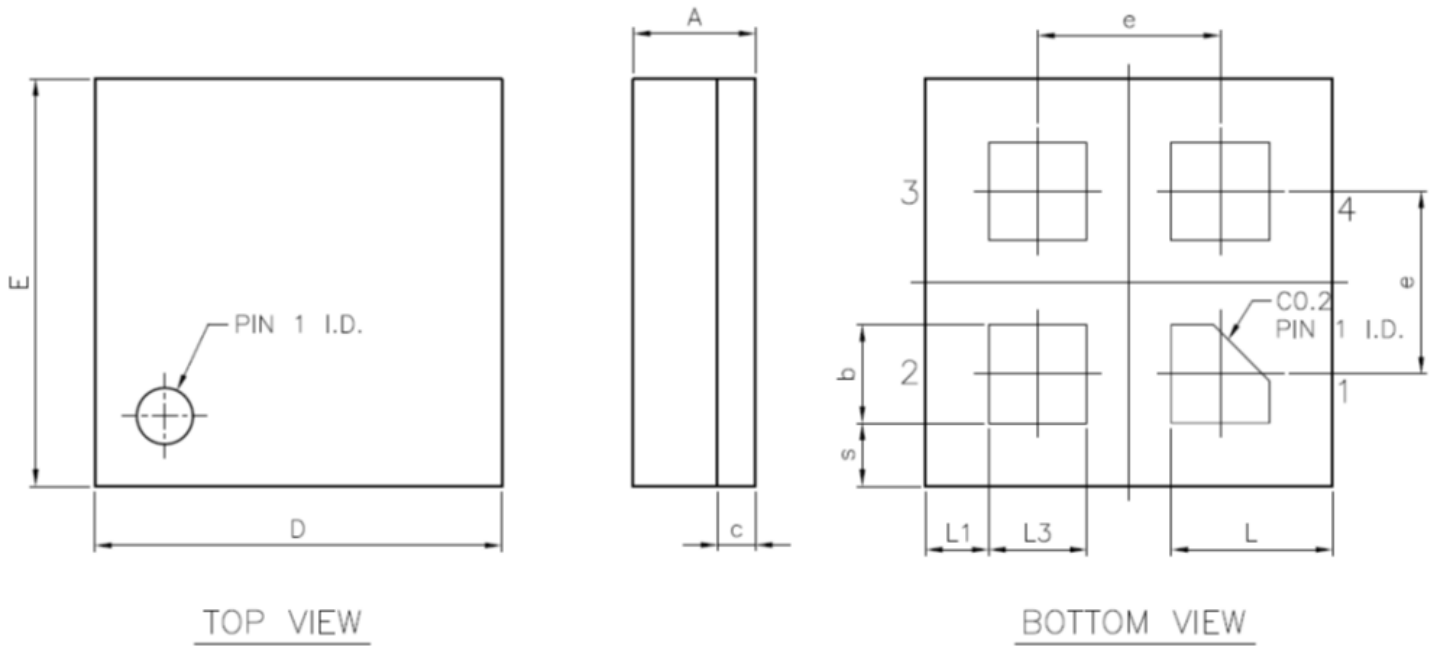

Figure 51: 3-Lead SOT23 Package Drawing

Table 3: CT813x 3-Lead SOT23 Package Dimensions

Symbol	Dimensions in Millimeters (mm)		
	Min.	Typ.	Max.
A	1.05	1.20	1.35
A1	0.00	0.10	0.15
A2	1.00	1.10	1.20
b	0.30	–	0.50
b1	0.30	0.35	0.45
c	0.08	–	0.22
c1	0.08	0.13	0.20
D	2.80	2.90	3.00
E	2.60	2.80	3.00
E1	1.50	1.60	1.70

Symbol	Dimensions in Millimeters (mm)		
	Min.	Typ.	Max.
e	0.95 BSC		
e1	1.90 BSC		
L	0.35	0.43	0.60
L1	0.50 REF		
L2	0.25 BSC		
R	0.10	–	–
R1	0.10	–	0.25
theta	0°	4°	8°
theta1	5°	6°	15°
theta2	5°	8°	15°



**NOTES:**

1. All dimensions are in millimeters.
2. Pin A1 ID is marked by ink or laser.

**Figure 52: 4-Lead LGA Package Drawing**

**Table 4: CT813x 4-Lead LGA Package Dimensions**

Symbol	Dimensions in Millimeters (mm)		
	Min.	Typ.	Max.
A	0.386	0.436	0.486
b	0.300	0.350	0.400
c	–	0.136 REF	–
D	1.400	1.450	1.500
E	1.400	1.450	1.500
e	–	0.650	–
L	0.525	0.575	0.625
L1	0.175	0.225	0.275
L3	0.300	0.350	0.400
s	0.175	0.225	0.275

TAPE AND REEL POCKET DRAWINGS AND DIMENSIONS

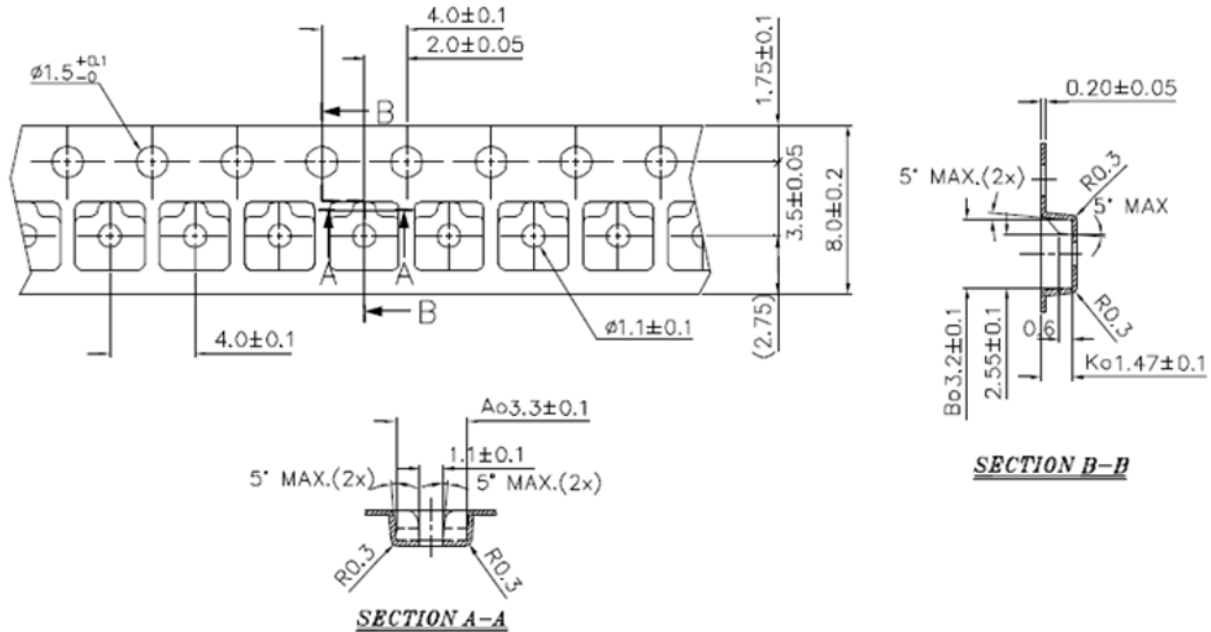

NOTES:

1. Material: Conductive Polystyrene.
2. Dimensions in mm.
3. 10 sprocket hole pitch cumulative tolerance  $\pm 0.20$  mm.
4. Camber not to exceed 1 mm in 100 mm.
5. Pocket position relative to sprocket hole measured as true position of pocket and not pocket hole.
6. (S.R.  $\Omega$ /sq) means surface electric resistivity of the carrier tape.

Figure 53: Tape and Pocket Drawing for 3-lead SOT23 Package

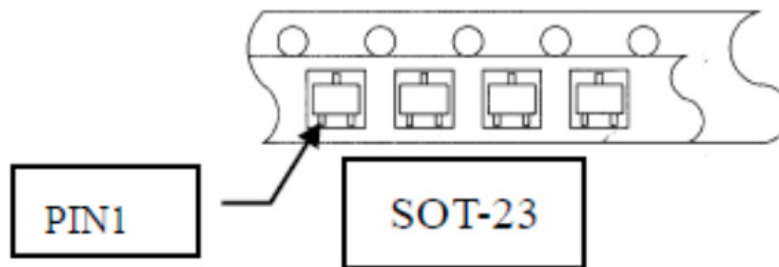

Figure 54: SOT23 Orientation in Tape Pocket

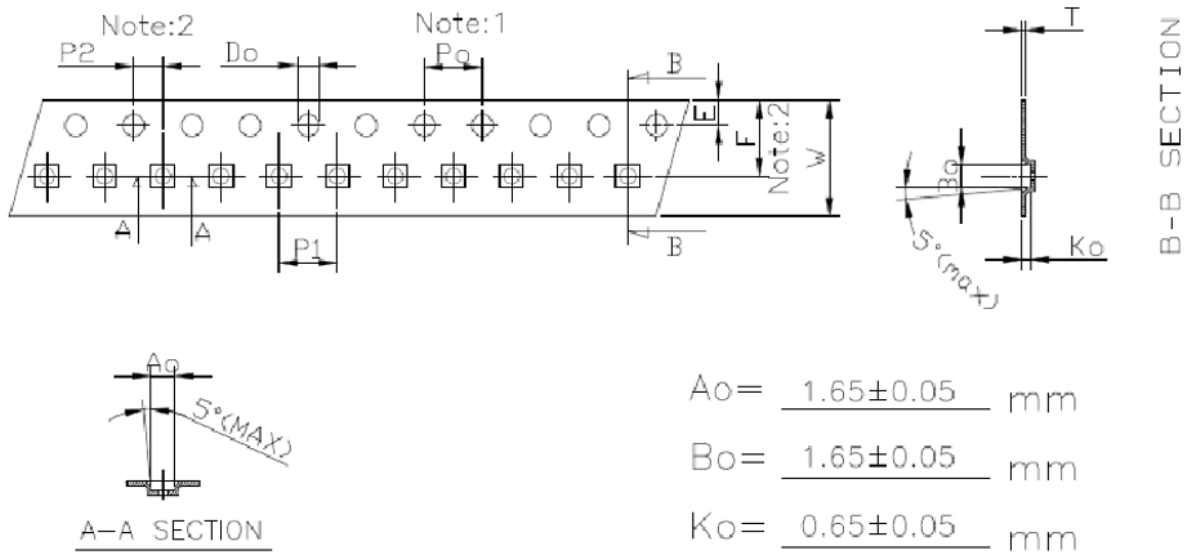

Figure 55: Tape and Pocket Drawing for LGA-4 Package

Table 5: LGA-4 Tape and Pocket Dimensions

Symbol	Specification
Po	4.00 mm ± 0.10 mm
P1	4.00 mm ± 0.10 mm
P2	2.00 mm ± 0.05 mm
Do	1.50 mm ± 0.10 mm
D1	1.10 mm ± 0.05 mm
E	1.75 mm ± 0.10 mm
F	3.50 mm ± 0.05 mm
10Po	40.00 mm ± 0.10 mm
W	8.00 mm ± 0.20 mm
T	0.25 mm ± 0.02 mm

NOTES:

- 10 sprocket hole pitch cumulative tolerance is ±0.10 mm.
- Pocket position is relative to sprocket hole measured as true position of pocket and not pocket hole.
- Ao and Bo measured on a plane of 0.3 mm above the bottom of the pocket to top surface of the carrier.
- Ko measured from a plane on the inside bottom of the pocket to the top surface of the carrier.
- Carrier camber shall not more than 1 mm per 100 mm through a length of 250 mm.

## PACKAGE INFORMATION

Table 6: CT813x Package Information

Part Number	Package Type	# of Leads	Package Quantity	Lead Finish	Eco Plan [1]	MSL Rating [2]	Operating Temperature (°C) [3]	Device Marking [4]
CT8131BV-IL4	LGA	4	3000	Sn	Green & RoHS	3	-40 to 85	L YZ
CT8131BV-HL4	LGA	4	3000	Sn	Green & RoHS	3	-40 to 125	L YZ
CT8131BV-IS3	SOT23	3	3000	Sn	Green & RoHS	1	-40 to 85	JD YWWS
CT8131BV-HS3	SOT23	3	3000	Sn	Green & RoHS	1	-40 to 125	JD YWWS
CT8132BH-IL4	LGA	4	3000	Sn	Green & RoHS	3	-40 to 85	G YZ
CT8132BH-HL4	LGA	4	3000	Sn	Green & RoHS	3	-40 to 125	G YZ
CT8132BH-IS3	SOT23	3	3000	Sn	Green & RoHS	1	-40 to 85	MG YWWS
CT8132BH-HS3	SOT23	3	3000	Sn	Green & RoHS	1	-40 to 125	MG YWWS
CT8132BL-IS3	SOT23	3	3000	Sn	Green & RoHS	1	-40 to 85	MB YWWS
CT8132BL-HS3	SOT23	3	3000	Sn	Green & RoHS	1	-40 to 125	MB YWWS
CT8132BV-IL4	LGA	4	3000	Sn	Green & RoHS	3	-40 to 85	M YZ
CT8132BV-HL4	LGA	4	3000	Sn	Green & RoHS	3	-40 to 125	M YZ
CT8132BV-IS3	SOT23	3	3000	Sn	Green & RoHS	1	-40 to 85	MA YWWS
CT8132BV-HS3	SOT23	3	3000	Sn	Green & RoHS	1	-40 to 125	MA YWWS
CT8132DM-IS3	SOT23	3	3000	Sn	Green & RoHS	1	-40 to 85	MD YWWS
CT8132DM-HS3	SOT23	3	3000	Sn	Green & RoHS	1	-40 to 125	MD YWWS
CT8132EK-IS3	SOT23	3	3000	Sn	Green & RoHS	1	-40 to 85	MF YWWS
CT8132EK-HS3	SOT23	3	3000	Sn	Green & RoHS	1	-40 to 125	MF YWWS
CT8132SK-IL4	LGA	4	3000	Au	Green & RoHS	3	-40 to 85	P YZ U YZ V YZ X YZ
CT8132SK-HL4	LGA	4	3000	Au	Green & RoHS	3	-40 to 125	
CT8132SK-IS3	SOT23	3	3000	Sn	Green & RoHS	1	-40 to 85	MC YWWS
CT8132SK-HS3	SOT23	3	3000	Sn	Green & RoHS	1	-40 to 125	MC YWWS
CT8132SL-IS3	SOT23	3	3000	Sn	Green & RoHS	1	-40 to 85	ME YWWS
CT8132SL-HS3	SOT23	3	3000	Sn	Green & RoHS	1	-40 to 125	ME YWWS

[1] RoHS is defined as semiconductor products that are compliant to the current EU RoHS requirements. It also will meet the requirement that RoHS substances do not exceed 0.1% by weight in homogeneous materials. Green is defined as the content of chlorine (Cl), bromine (Br), and antimony trioxide based flame retardants satisfy JS709B low halogen requirements of  $\leq 1,000$  ppm.

[2] MSL Rating = Moisture Sensitivity Level Rating as defined by JEDEC standard classifications.

[3] Package will withstand ambient temperature range of  $-40^{\circ}\text{C}$  to  $150^{\circ}\text{C}$  and storage temperature range of  $-65^{\circ}\text{C}$  to  $150^{\circ}\text{C}$ .

[4] Device Marking for SOT23 is defined as XZ YWWS where XZ = part number nominator, Y = year, WW = work week, and S = sequential number. LGA is defined as X where X = part number nominator and YZ = date code information.

## Revision History

Number	Date	Description
1	December 11, 2023	Document rebranded and minor editorial updates
2	February 29, 2024	Updated Selection Guide (page 2)
3	March 22, 2024	Updated Operate Point and Hysteresis values for CT8132SK (page 18)
4	May 14, 2024	Changed "latch(es)" to "switch(es)"

Copyright 2024, Allegro MicroSystems.

Allegro MicroSystems reserves the right to make, from time to time, such departures from the detail specifications as may be required to permit improvements in the performance, reliability, or manufacturability of its products. Before placing an order, the user is cautioned to verify that the information being relied upon is current.

Allegro's products are not to be used in any devices or systems, including but not limited to life support devices or systems, in which a failure of Allegro's product can reasonably be expected to cause bodily harm.

The information included herein is believed to be accurate and reliable. However, Allegro MicroSystems assumes no responsibility for its use; nor for any infringement of patents or other rights of third parties which may result from its use.

Copies of this document are considered uncontrolled documents.

For the latest version of this document, visit our website:

[www.allegromicro.com](http://www.allegromicro.com)