

# NTLUS4C16N

## MOSFET – Power, Single, N-Channel, $\mu$ Cool, UDFN6, 1.6x1.6x0.55 mm 30 V, 11.7 A

### Features

- UDFN Package with Exposed Drain Pads for Excellent Thermal Conduction
- Low Profile UDFN 1.6 x 1.6 x 0.55 mm for Board Space Saving
- Ultra Low  $R_{DS(on)}$
- These Devices are Pb-Free, Halogen Free/BFR Free and are RoHS Compliant

### Applications

- Power Load Switch
- Wireless Charging
- DC-DC Converters

### MAXIMUM RATINGS ( $T_J = 25^\circ\text{C}$ unless otherwise stated)

| Parameter   |              | Symbol                   | Value      | Unit                     |                  |
|---|--------------|--------------------------|------------|--------------------------|------------------|
| Drain-to-Source Voltage   |              | $V_{DSS}$                | 30         | V                        |                  |
| Gate-to-Source Voltage  |              | $V_{GS}$                 | $\pm 12$   | V                        |                  |
| Continuous Drain Current (Note 1)                                 | Steady State | $T_A = 25^\circ\text{C}$ | $I_D$      | 9.4                      | A                |
|   |              |                          |            | $T_A = 85^\circ\text{C}$ |                  |
|   | $t \leq 5$ s | $T_A = 25^\circ\text{C}$ | 11.7       |                          |                  |
| Power Dissipation (Note 1)  | Steady State | $T_A = 25^\circ\text{C}$ | $P_D$      | 1.53                     | W                |
|   |              |                          |            | $t \leq 5$ s             |                  |
| Continuous Drain Current (Note 2)                                 | Steady State | $T_A = 25^\circ\text{C}$ | $I_D$      | 6.1                      | A                |
|   |              | $T_A = 85^\circ\text{C}$ |            | 4.4                      |                  |
| Power Dissipation (Note 2)  |              | $T_A = 25^\circ\text{C}$ | $P_D$      | 0.65                     | W                |
| Pulsed Drain Current  |              | $t_p = 10$ $\mu$ s       | $I_{DM}$   | 28                       | A                |
| MOSFET Operating Junction and Storage Temperature                 |              | $T_J, T_{STG}$           | -55 to 150 |                          | $^\circ\text{C}$ |
| Source Current (Body Diode) (Note 1)                              |              | $I_S$                    | 2.0        |                          | A                |
| Lead Temperature for Soldering Purposes (1/8" from case for 10 s) |              | $T_L$                    | 260        |                          | $^\circ\text{C}$ |

Stresses exceeding those listed in the Maximum Ratings table may damage the device. If any of these limits are exceeded, device functionality should not be assumed, damage may occur and reliability may be affected.

1. Surface Mounted on FR4 Board using 1 in sq pad size (Cu area = 1.127 in sq [2 oz] including traces).
2. Surface-mounted on FR4 board using the minimum recommended pad size, 2 oz. Cu.



ON Semiconductor®

[www.onsemi.com](http://www.onsemi.com)

### MOSFET

| $V_{(BR)DSS}$ | $R_{DS(on)}$ MAX        | $I_D$ MAX |
|---------------|-------------------------|-----------|
| 30 V          | 11.4 m $\Omega$ @ 10 V  | 11.7 A    |
|               | 13.3 m $\Omega$ @ 4.5 V |           |
|               | 14.2 m $\Omega$ @ 3.7 V |           |
|               | 15.2 m $\Omega$ @ 3.3 V |           |
|               | 20 m $\Omega$ @ 2.5 V   |           |
|               | 40 m $\Omega$ @ 1.8 V   |           |

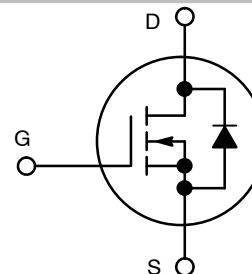

N-CHANNEL MOSFET

### MARKING DIAGRAM

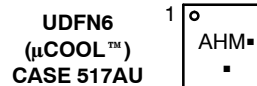
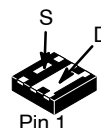

AH = Specific Device Code  
M = Date Code  
▪ = Pb-Free Package

(Note: Microdot may be in either location)

### PIN CONNECTIONS

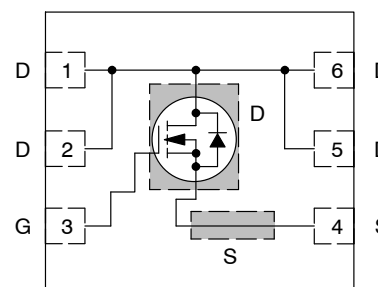

(Top View)

### ORDERING INFORMATION

See detailed ordering and shipping information on page 3 of this data sheet.

# NTLUS4C16N

## THERMAL RESISTANCE RATINGS

| Parameter   | Symbol          | Max   | Unit |
|---|-----------------|-------|------|
| Junction-to-Ambient – Steady State (Note 3)         | $R_{\theta JA}$ | 81.7  | °C/W |
| Junction-to-Ambient – $t \leq 5$ s (Note 3)         | $R_{\theta JA}$ | 52.8  |      |
| Junction-to-Ambient – Steady State min Pad (Note 4) | $R_{\theta JA}$ | 193.6 |      |

- Surface-mounted on FR4 board using 1 in sq pad size (Cu area = 1.127 in sq [2 oz] including traces).
- Surface-mounted on FR4 board using the minimum recommended pad size, 2 oz. Cu.

## ELECTRICAL CHARACTERISTICS ( $T_J = 25^\circ\text{C}$ unless otherwise specified)

| Parameter | Symbol | Test Condition | Min | Typ | Max | Units |
|-----------|--------|----------------|-----|-----|-----|-------|
|-----------|--------|----------------|-----|-----|-----|-------|

### OFF CHARACTERISTICS

|   |                   |  |                           |    |           |         |
|---|-------------------|--|---------------------------|----|-----------|---------|
| Drain-to-Source Breakdown Voltage                         | $V_{(BR)DSS}$     | $V_{GS} = 0$ V, $I_D = 250$ $\mu$ A            | 30                        |    |           | V       |
| Drain-to-Source Breakdown Voltage Temperature Coefficient | $V_{(BR)DSS}/T_J$ | $I_D = 250$ $\mu$ A, ref to $25^\circ\text{C}$ |                           | 11 |           | mV/°C   |
| Zero Gate Voltage Drain Current                           | $I_{DSS}$         | $V_{GS} = 0$ V,<br>$V_{DS} = 24$ V             | $T_J = 25^\circ\text{C}$  |    | 1         | $\mu$ A |
|   |                   |  | $T_J = 125^\circ\text{C}$ |    | 10        |         |
| Gate-to-Source Leakage Current                            | $I_{GSS}$         | $V_{DS} = 0$ V, $V_{GS} = \pm 12$ V            |                           |    | $\pm 100$ | nA      |

### ON CHARACTERISTICS (Note 5)

|                                      |                  |   |     |      |      |            |
|--------------------------------------|------------------|---|-----|------|------|------------|
| Gate Threshold Voltage               | $V_{GS(TH)}$     | $V_{GS} = V_{DS}$ , $I_D = 250$ $\mu$ A | 0.6 |      | 1.1  | V          |
| Negative Threshold Temp. Coefficient | $V_{GS(TH)}/T_J$ |   |     | 3    |      | mV/°C      |
| Drain-to-Source On Resistance        | $R_{DS(on)}$     | $V_{GS} = 10$ V, $I_D = 8.0$ A          |     | 9.3  | 11.4 | m $\Omega$ |
|                                      |                  | $V_{GS} = 4.5$ V, $I_D = 5.0$ A         |     | 10.7 | 13.3 |            |
|                                      |                  | $V_{GS} = 3.7$ V, $I_D = 3.0$ A         |     | 11.4 | 14.2 |            |
|                                      |                  | $V_{GS} = 3.3$ V, $I_D = 3.0$ A         |     | 12.0 | 15.2 |            |
|                                      |                  | $V_{GS} = 2.5$ V, $I_D = 2.5$ A         |     | 14.3 | 20   |            |
|                                      |                  | $V_{GS} = 1.8$ V, $I_D = 2.5$ A         |     | 26   | 40   |            |
| Forward Transconductance             | $g_{FS}$         | $V_{DS} = 1.5$ V, $I_D = 5.0$ A         |     | 31   |      | S          |

### CHARGES, CAPACITANCES & GATE RESISTANCE

|                              |              |   |  |     |  |    |
|------------------------------|--------------|---|--|-----|--|----|
| Input Capacitance            | $C_{ISS}$    | $V_{GS} = 0$ V, $f = 1$ MHz,<br>$V_{DS} = 15$ V     |  | 690 |  | pF |
| Output Capacitance           | $C_{OSS}$    |   |  | 305 |  |    |
| Reverse Transfer Capacitance | $C_{RSS}$    |   |  | 26  |  |    |
| Total Gate Charge            | $Q_{G(TOT)}$ | $V_{GS} = 4.5$ V, $V_{DS} = 15$ V;<br>$I_D = 5.0$ A |  | 7.5 |  | nC |
| Threshold Gate Charge        | $Q_{G(TH)}$  |   |  | 0.6 |  |    |
| Gate-to-Source Charge        | $Q_{GS}$     |   |  | 1.3 |  |    |
| Gate-to-Drain Charge         | $Q_{GD}$     |   |  | 1.4 |  |    |

### SWITCHING CHARACTERISTICS, $V_{GS} = 4.5$ V (Note 6)

|                     |              |   |  |      |  |    |
|---------------------|--------------|---|--|------|--|----|
| Turn-On Delay Time  | $t_{d(ON)}$  | $V_{GS} = 4.5$ V, $V_{DD} = 15$ V,<br>$I_D = 5.0$ A, $R_G = 1$ $\Omega$ |  | 6.0  |  | ns |
| Rise Time           | $t_r$        |   |  | 14.5 |  |    |
| Turn-Off Delay Time | $t_{d(OFF)}$ |   |  | 17.5 |  |    |
| Fall Time           | $t_f$        |   |  | 2.5  |  |    |

### DRAIN-SOURCE DIODE CHARACTERISTICS

|                       |          |                                  |                           |  |     |     |   |
|-----------------------|----------|----------------------------------|---------------------------|--|-----|-----|---|
| Forward Diode Voltage | $V_{SD}$ | $V_{GS} = 0$ V,<br>$I_S = 2.0$ A | $T_J = 25^\circ\text{C}$  |  | 0.7 | 1.0 | V |
|                       |          |                                  | $T_J = 125^\circ\text{C}$ |  | 0.5 |     |   |

Product parametric performance is indicated in the Electrical Characteristics for the listed test conditions, unless otherwise noted. Product performance may not be indicated by the Electrical Characteristics if operated under different conditions.

- Pulse Test: pulse width  $\leq 300$   $\mu$ s, duty cycle  $\leq 2\%$ .
- Switching characteristics are independent of operating junction temperatures.

# NTLUS4C16N

## ELECTRICAL CHARACTERISTICS (T<sub>J</sub> = 25°C unless otherwise specified)

| Parameter                                 | Symbol          | Test Condition   | Min | Typ  | Max | Units |
|---|-----------------|--|-----|------|-----|-------|
| <b>DRAIN-SOURCE DIODE CHARACTERISTICS</b> |                 |  |     |      |     |       |
| Reverse Recovery Time                     | t <sub>RR</sub> | V <sub>GS</sub> = 0 V, dI <sub>S</sub> /dt = 100 A/μs,<br>I <sub>S</sub> = 2.0 A |     | 21   |     | ns    |
| Charge Time                               | t <sub>a</sub>  |  |     | 11   |     |       |
| Discharge Time                            | t <sub>b</sub>  |  |     | 10   |     |       |
| Reverse Recovery Charge                   | Q <sub>RR</sub> |  |     | 10.5 |     | nC    |

Product parametric performance is indicated in the Electrical Characteristics for the listed test conditions, unless otherwise noted. Product performance may not be indicated by the Electrical Characteristics if operated under different conditions.

5. Pulse Test: pulse width ≤ 300 μs, duty cycle ≤ 2%.

6. Switching characteristics are independent of operating junction temperatures.

## DEVICE ORDERING INFORMATION

| Device        | Package            | Shipping <sup>†</sup> |
|---------------|--------------------|-----------------------|
| NTLUS4C16NTAG | UDFN6<br>(Pb-Free) | 3000 / Tape & Reel    |
| NTLUS4C16NTBG | UDFN6<br>(Pb-Free) | 3000 / Tape & Reel    |

<sup>†</sup>For information on tape and reel specifications, including part orientation and tape sizes, please refer to our Tape and Reel Packaging Specifications Brochure, BRD8011/D.

# NTLUS4C16N

## TYPICAL CHARACTERISTICS

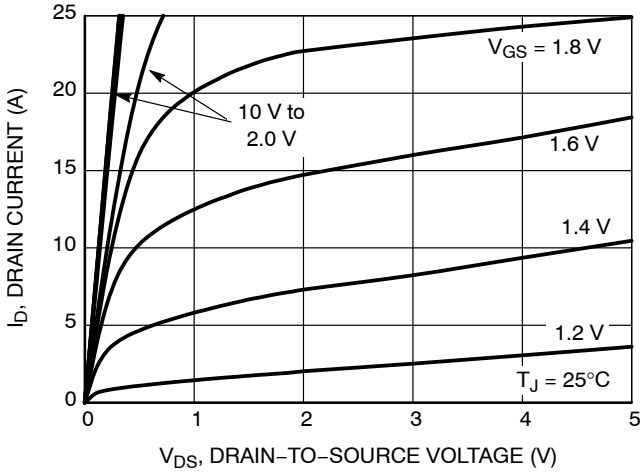

Figure 1. On-Region Characteristics

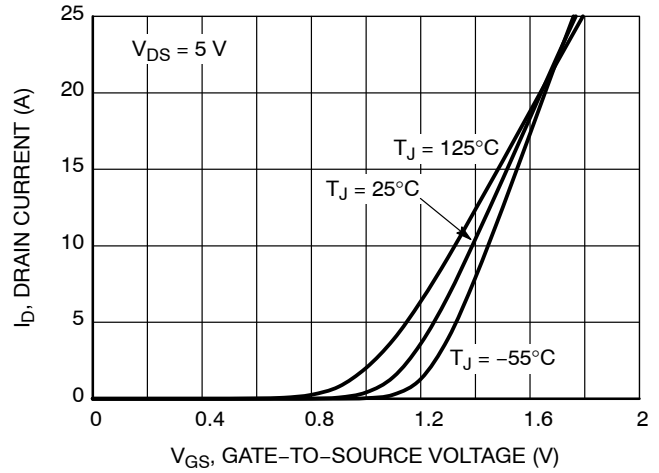

Figure 2. Transfer Characteristics

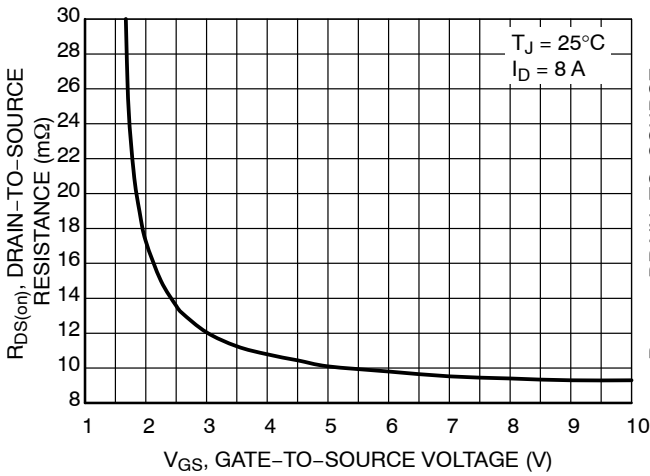

Figure 3. On-Resistance vs. Gate-to-Source Voltage

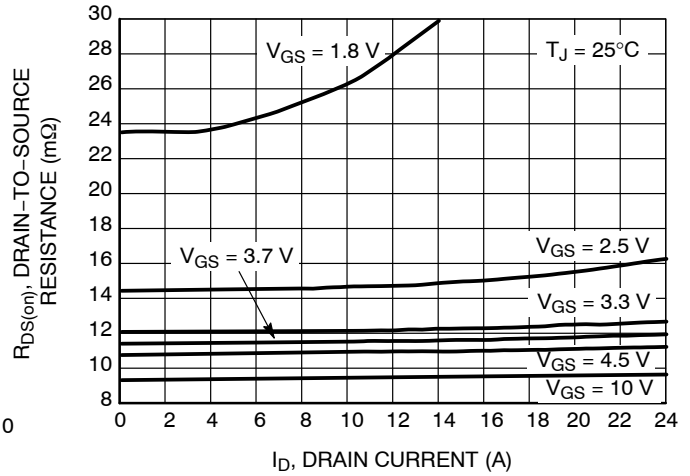

Figure 4. On-Resistance vs. Drain Current and Gate Voltage

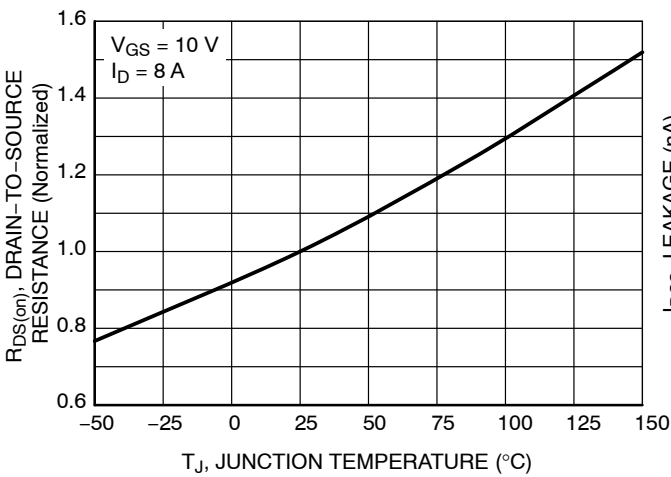

Figure 5. On-Resistance Variation with Temperature

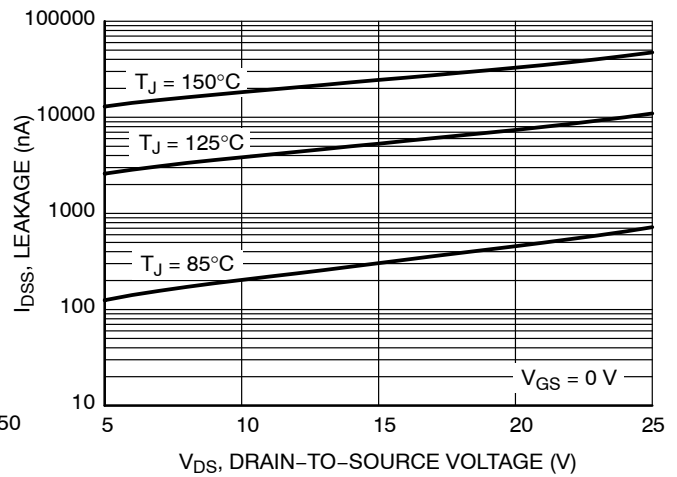

Figure 6. Drain-to-Source Leakage Current vs. Voltage

# NTLUS4C16N

## TYPICAL CHARACTERISTICS

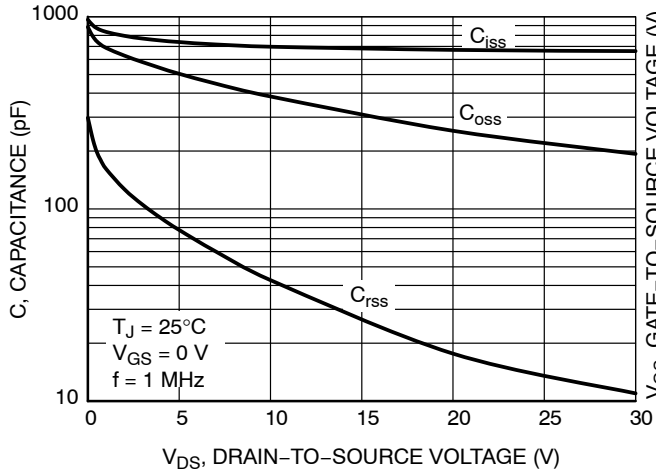

Figure 7. Capacitance Variation

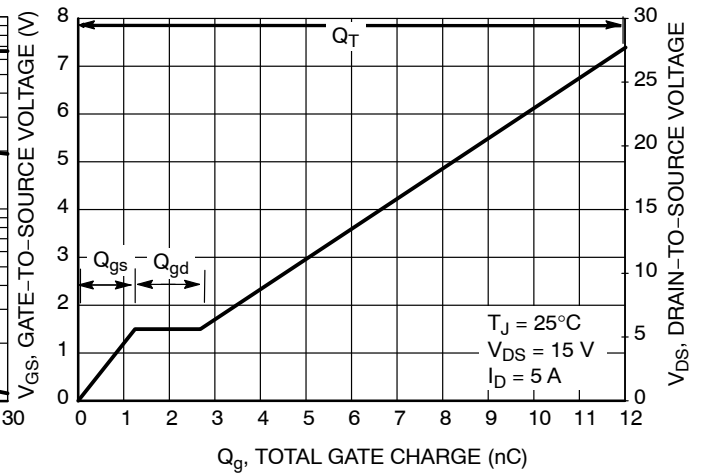

Figure 8. Gate-to-Source and Drain-to-Source Voltage vs. Total Charge

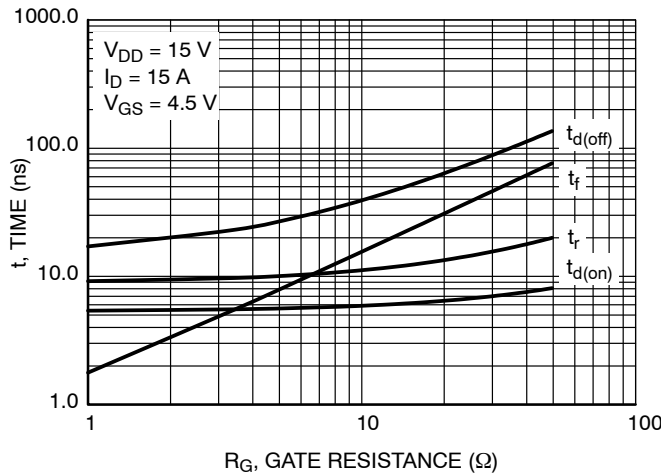

Figure 9. Resistive Switching Time Variation vs. Gate Resistance

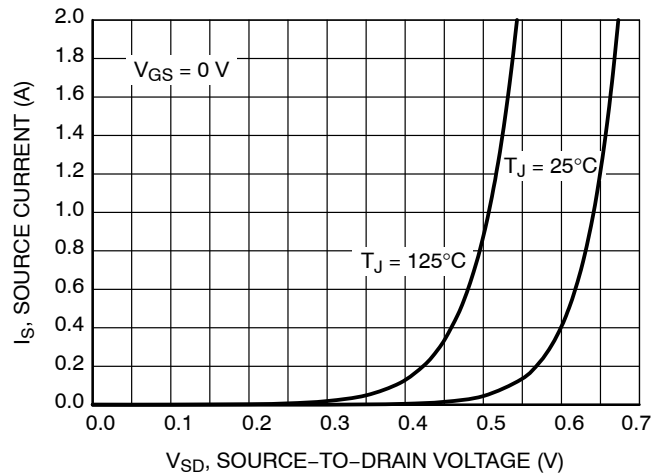

Figure 10. Diode Forward Voltage vs. Current

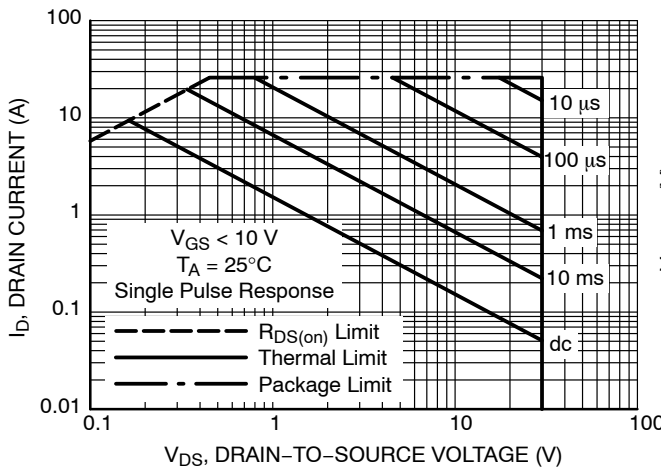

Figure 11. Maximum Rated Forward Biased Safe Operating Area

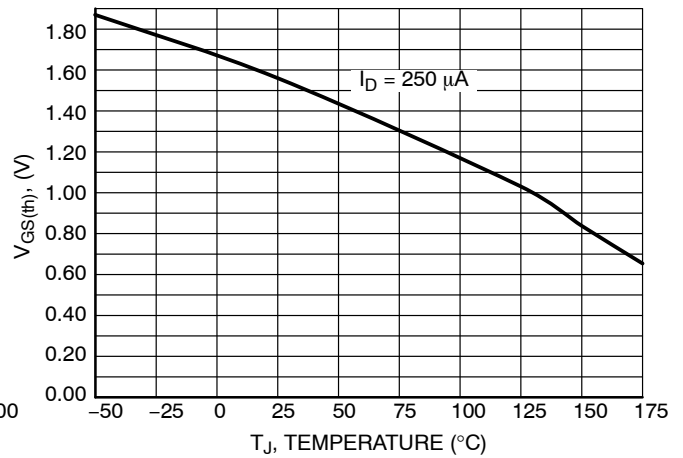

Figure 12.  $V_{GS(th)}$  vs. Temperature

# NTLUS4C16N

## TYPICAL CHARACTERISTICS

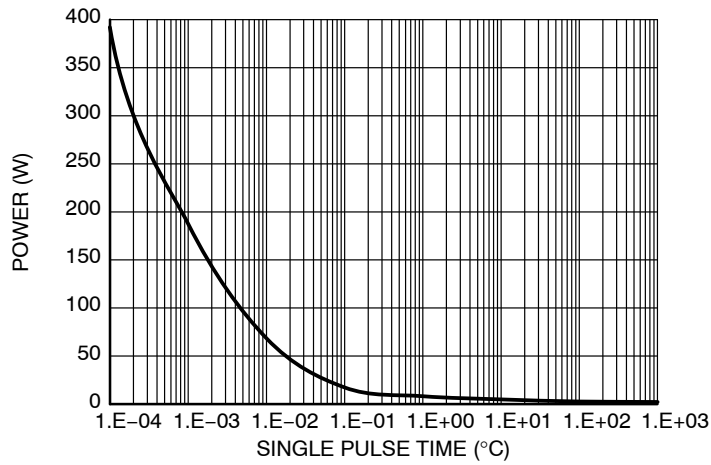

Figure 13. Single Pulse Maximum Power Dissipation

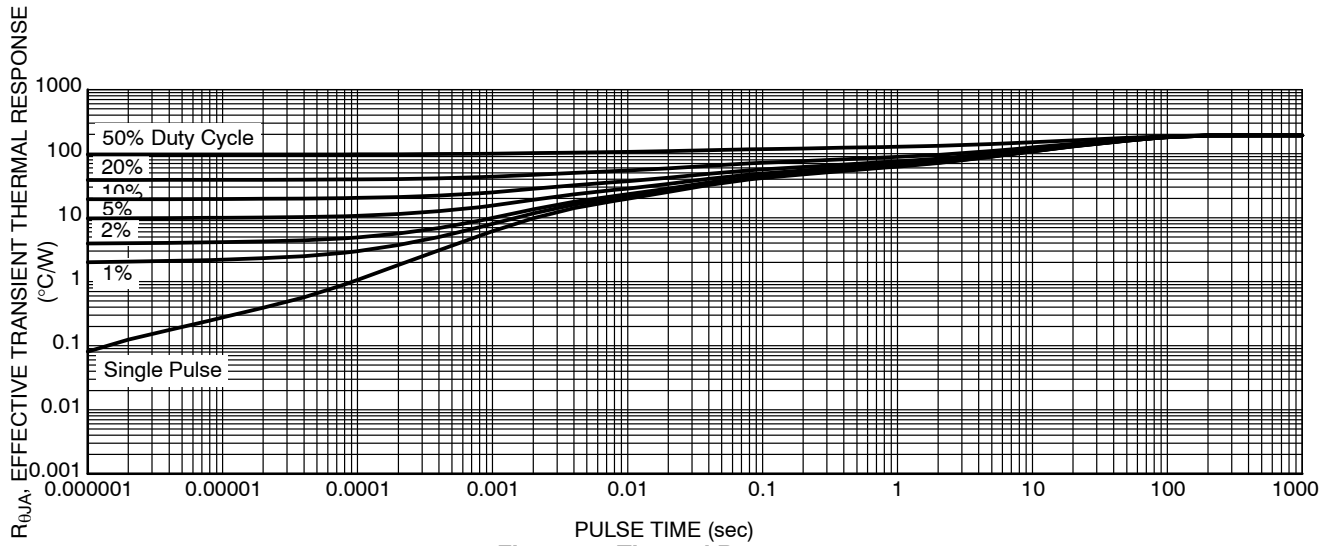

Figure 14. Thermal Response

# MECHANICAL CASE OUTLINE

## PACKAGE DIMENSIONS

ON Semiconductor®



### UDFN6 1.6x1.6, 0.5P CASE 517AU-01 ISSUE O

DATE 16 OCT 2008

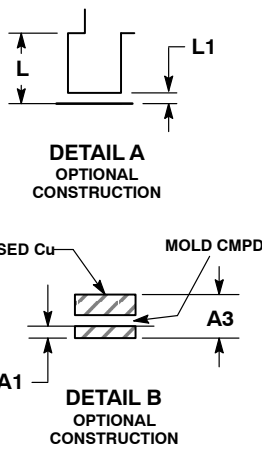
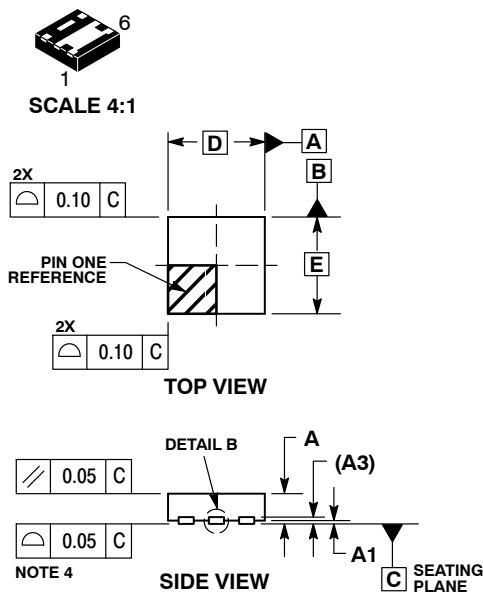

- NOTES:
1. DIMENSIONING AND TOLERANCING PER ASME Y14.5M, 1994.
  2. CONTROLLING DIMENSION: MILLIMETERS.
  3. DIMENSION b APPLIES TO PLATED TERMINAL AND IS MEASURED BETWEEN 0.15 AND 0.30 mm FROM TERMINAL.
  4. COPLANARITY APPLIES TO THE EXPOSED PAD AS WELL AS THE TERMINALS.

| MILLIMETERS |      |      |
|-------------|------|------|
| DIM         | MIN  | MAX  |
| A           | 0.45 | 0.55 |
| A1          | 0.00 | 0.05 |
| A3          | 0.13 | REF  |
| b           | 0.20 | 0.30 |
| D           | 1.60 | BSC  |
| E           | 1.60 | BSC  |
| e           | 0.50 | BSC  |
| D1          | 0.62 | 0.72 |
| D2          | 0.15 | 0.25 |
| E2          | 0.57 | 0.67 |
| F           | 0.55 | BSC  |
| G           | 0.25 | BSC  |
| L           | 0.20 | 0.30 |
| L1          | ---  | 0.15 |

### GENERIC MARKING DIAGRAM\*

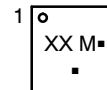

- XX = Specific Device Code
- M = Date Code
- = Pb-Free Package

(Note: Microdot may be in either location)

\*This information is generic. Please refer to device data sheet for actual part marking.

Pb-Free indicator, "G" or microdot "▪", may or may not be present.

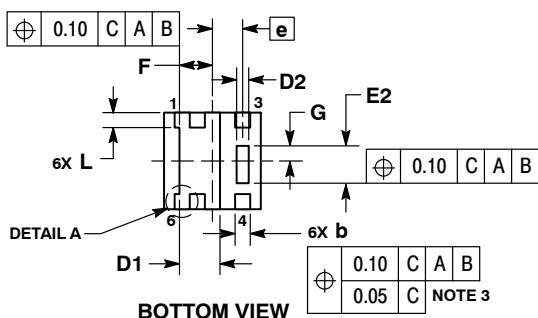

### SOLDERMASK DEFINED MOUNTING FOOTPRINT\*

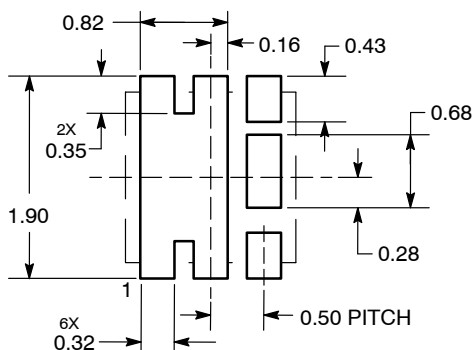

\*For additional information on our Pb-Free strategy and soldering details, please download the ON Semiconductor Soldering and Mounting Techniques Reference Manual, SOLDERRM/D.

|                         |                             |  |
|-------------------------|-----------------------------|--|
| <b>DOCUMENT NUMBER:</b> | <b>98AON35147E</b>          | Electronic versions are uncontrolled except when accessed directly from the Document Repository. Printed versions are uncontrolled except when stamped "CONTROLLED COPY" in red. |
| <b>DESCRIPTION:</b>     | <b>UDFN6, 1.6X1.6, 0.5P</b> | <b>PAGE 1 OF 1</b>   |

ON Semiconductor and ON are trademarks of Semiconductor Components Industries, LLC dba ON Semiconductor or its subsidiaries in the United States and/or other countries. ON Semiconductor reserves the right to make changes without further notice to any products herein. ON Semiconductor makes no warranty, representation or guarantee regarding the suitability of its products for any particular purpose, nor does ON Semiconductor assume any liability arising out of the application or use of any product or circuit, and specifically disclaims any and all liability, including without limitation special, consequential or incidental damages. ON Semiconductor does not convey any license under its patent rights nor the rights of others.

**onsemi**, **Onsemi**, and other names, marks, and brands are registered and/or common law trademarks of Semiconductor Components Industries, LLC dba "**onsemi**" or its affiliates and/or subsidiaries in the United States and/or other countries. **onsemi** owns the rights to a number of patents, trademarks, copyrights, trade secrets, and other intellectual property. A listing of **onsemi**'s product/patent coverage may be accessed at [www.onsemi.com/site/pdf/Patent-Marking.pdf](http://www.onsemi.com/site/pdf/Patent-Marking.pdf). **onsemi** reserves the right to make changes at any time to any products or information herein, without notice. The information herein is provided "as-is" and **onsemi** makes no warranty, representation or guarantee regarding the accuracy of the information, product features, availability, functionality, or suitability of its products for any particular purpose, nor does **onsemi** assume any liability arising out of the application or use of any product or circuit, and specifically disclaims any and all liability, including without limitation special, consequential or incidental damages. Buyer is responsible for its products and applications using **onsemi** products, including compliance with all laws, regulations and safety requirements or standards, regardless of any support or applications information provided by **onsemi**. "Typical" parameters which may be provided in **onsemi** data sheets and/or specifications can and do vary in different applications and actual performance may vary over time. All operating parameters, including "Typicals" must be validated for each customer application by customer's technical experts. **onsemi** does not convey any license under any of its intellectual property rights nor the rights of others. **onsemi** products are not designed, intended, or authorized for use as a critical component in life support systems or any FDA Class 3 medical devices or medical devices with a same or similar classification in a foreign jurisdiction or any devices intended for implantation in the human body. Should Buyer purchase or use **onsemi** products for any such unintended or unauthorized application, Buyer shall indemnify and hold **onsemi** and its officers, employees, subsidiaries, affiliates, and distributors harmless against all claims, costs, damages, and expenses, and reasonable attorney fees arising out of, directly or indirectly, any claim of personal injury or death associated with such unintended or unauthorized use, even if such claim alleges that **onsemi** was negligent regarding the design or manufacture of the part. **onsemi** is an Equal Opportunity/Affirmative Action Employer. This literature is subject to all applicable copyright laws and is not for resale in any manner.

## ADDITIONAL INFORMATION

### TECHNICAL PUBLICATIONS:

Technical Library: [www.onsemi.com/design/resources/technical-documentation](http://www.onsemi.com/design/resources/technical-documentation)  
onsemi Website: [www.onsemi.com](http://www.onsemi.com)

### ONLINE SUPPORT: [www.onsemi.com/support](http://www.onsemi.com/support)

For additional information, please contact your local Sales Representative at [www.onsemi.com/support/sales](http://www.onsemi.com/support/sales)