



# P-DUKE POWER

## PDL09W Series

DC-DC Converter  
Up to 9 Watts

### 3

YEARS  
WARRANTY

ROHS  
COMPLIANT

REACH  
COMPLIANT

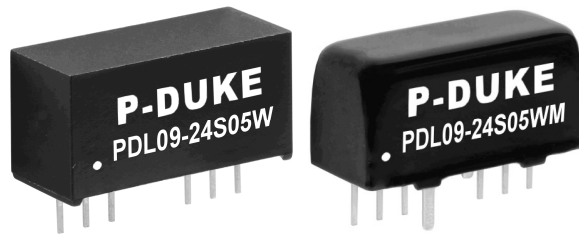

Automation



Datacom



IPC



Industry



Measurement



Telecom



Automobile



Boat



Charger



Medical



PV



Railway



1600  
VDC  
Isolation  
Voltage

4 : 1  
Wide  
Input  
Range

LOW  
Standby  
Power

NO  
Min. Load  
Required

REMOTE  
ON  
OFF

OCP

SCP

### PART NUMBER STRUCTURE

PDL09	-	48	S	05	W	M
Series Name		Input Voltage (VDC)	Output Quantity	Output Voltage (VDC)	Input Range	Case Option
		24:9~36 48:18~75	S:Single	3P3:3.3 05:5 09:9 12:12 15:15 24:24	4 : 1	M: Standard type Metal case □: Plastic case
			D: Dual	05:±5 12:±12 15:±15		

**TECHNICAL SPECIFICATION** All specifications are typical at nominal input, full load and 25°C unless otherwise noted

Model Number	Input Range	Output Voltage	Output Current @Full Load	Input Current @ No Load	Efficiency	Maximum Capacitor Load
	VDC	VDC	mA	mA	%	μF
PDL09-24S3P3WM	9 ~ 36	3.3	2000	5	82	2600
PDL09-24S05WM	9 ~ 36	5	1600	5	85	1300
PDL09-24S09WM	9 ~ 36	9	1000	5	88	800
PDL09-24S12WM	9 ~ 36	12	750	5	88	560
PDL09-24S15WM	9 ~ 36	15	600	5	89	560
PDL09-24S24WM	9 ~ 36	24	375	9	89	200
PDL09-24D05WM	9 ~ 36	±5	±800	9	86	±800
PDL09-24D12WM	9 ~ 36	±12	±375	9	88	±390
PDL09-24D15WM	9 ~ 36	±15	±300	9	88	±200
PDL09-48S3P3WM	18 ~ 75	3.3	2000	3	82	2600
PDL09-48S05WM	18 ~ 75	5	1600	3	85	1300
PDL09-48S09WM	18 ~ 75	9	1000	3	89	800
PDL09-48S12WM	18 ~ 75	12	750	3	89	560
PDL09-48S15WM	18 ~ 75	15	600	3	89	560
PDL09-48S24WM	18 ~ 75	24	375	3	89	200
PDL09-48D05WM	18 ~ 75	±5	±800	3	85	±800
PDL09-48D12WM	18 ~ 75	±12	±375	3	88	±390
PDL09-48D15WM	18 ~ 75	±15	±300	4	87	±200

## INPUT SPECIFICATIONS

Parameter	Conditions	Min.	Typ.	Max.	Unit
Operating input voltage range	24Vin(nom) 48Vin(nom)	9 18	24 48	36 75	VDC
Start up time	Constant resistive load Power up Remote ON/OFF		50 50		ms
Input surge voltage	1 second, max. 24Vin(nom) 48Vin(nom)			50 100	VDC
Input filter				Capacitor type	
Remote ON/OFF	DC-DC ON DC-DC OFF  Ctrl pin applied current via 1kΩ  Remote off input current  Application circuit DC-DC ON		Open or high impedance 2 3	4 3 2.5	mA mA mA

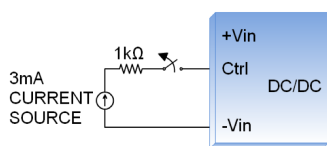
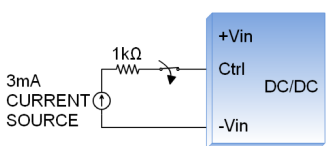
OUTPUT SPECIFICATIONS						
Parameter	Conditions		Min.	Typ.	Max.	Unit
Voltage accuracy			-1.0		+1.0	%
Line regulation	Low Line to High Line at Full Load		-0.2		+0.2	%
Load regulation	No Load to Full Load	Single	-1.0		+1.0	%
		Dual	-1.0		+1.0	
Cross regulation	Asymmetrical load 25%/100% FL	Dual	-5.0		+5.0	%
Ripple and noise	20MHz bandwidth	3.3Vout, 5Vout, 9Vout		50		mVp-p
	With a 1µF/50V X7R MLCC	12Vout, 15Vout, 24Vout		75		
Temperature coefficient			-0.02		+0.02	%/°C
Transient response recovery time	25% load step change			250		µs
Over load protection	% of Iout rated; Hiccup mode			180		%
Short circuit protection			Continuous, automatic recovery			

GENERAL SPECIFICATIONS						
Parameter	Conditions		Min.	Typ.	Max.	Unit
Isolation voltage	1 minute	Input to Output	1600			VDC
		Metal Case	1600			
		Plastic Case	1000			
Isolation resistance	Input (Output) to Case		1			GΩ
Isolation capacitance	500VDC				50	pF
		Metal Case			50	
		Plastic Case				
Switching frequency				400		kHz
		Single		500		
		Dual				
Safety approvals	IEC /UL/ EN60950-1 IEC /UL/ EN62368-1					UL:E193009 CB:UL(Demko)
Case material						Copper Non-conductive black plastic
Base material						None
Potting material						Silicone (UL94 V-0)
Weight					5.9g (0.21oz)	
		Metal Case			4.8g (0.17oz)	
		Plastic Case				
MTBF	MIL-HDBK-217F, Full load	Metal Case				2.939 x 10 <sup>6</sup> hrs
		Plastic Case				2.696 x 10 <sup>6</sup> hrs

ENVIRONMENTAL SPECIFICATIONS						
Parameter	Conditions		Min.	Typ.	Max.	Unit
Operating ambient temperature	With derating		-40		+100	°C
Storage temperature range			-55		+125	°C
Thermal shock						MIL-STD-810F
Vibration						MIL-STD-810F
Relative humidity						5% to 95% RH

EMC SPECIFICATIONS			
Parameter	Conditions		Level
EMI	EN55032	With external components	Class A · Class B
ESD	EN61000-4-2	Air ± 8kV and Contact ± 6kV	Perf. Criteria A
Radiated immunity	EN61000-4-3	20 V/m	Perf. Criteria A
Fast transient	EN61000-4-4	± 2kV	Perf. Criteria A
	PDL09-24□□□W	With an aluminum electrolytic capacitor (Nippon chemi-con KY series, 220μF/100V) and a TVS(SMDJ70A, 70V, 3000Watt peak pulse power) in parallel.	
	PDL09-48□□□W	With an aluminum electrolytic capacitor (Nippon chemi-con KY series, 220μF/100V) and a TVS (SMDJ120A, 120V, 3000Watt peak pulse power) in parallel.	
Surge	EN61000-4-5	± 2kV	Perf. Criteria A
	PDL09-24□□□W	With an aluminum electrolytic capacitor (Nippon chemi-con KY series, 220μF/100V) and a TVS(SMDJ70A, 70V, 3000Watt peak pulse power) in parallel.	
	PDL09-48□□□W	With an aluminum electrolytic capacitor (Nippon chemi-con KY series, 220μF/100V) and a TVS (SMDJ120A, 120V, 3000Watt peak pulse power) in parallel.	
Conducted immunity	EN61000-4-6	10 Vr.m.s	Perf. Criteria A
Power frequency magnetic field	EN61000-4-8	100A/m continuous; 1000A/m 1 second	Perf. Criteria A

**CAUTION:** This power module is not internally fused. An input line fuse must always be used.

**CHARACTERISTIC CURVE**

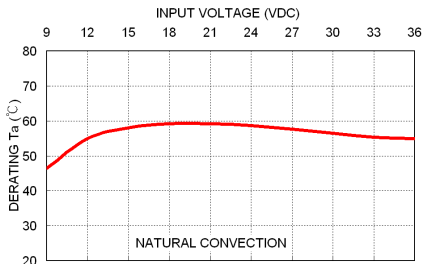

PDL09-24D12W Derating Ta v.s. Input Voltage (at Full Load)

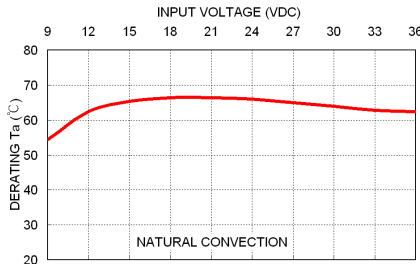

PDL09-24D12WM Derating Ta v.s. Input Voltage (at Full Load)

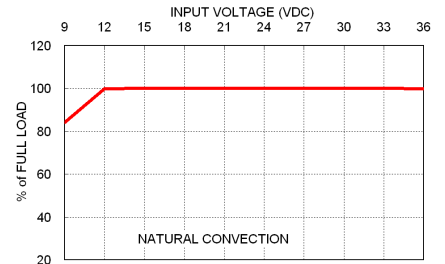

PDL09-24D12W Load Derating v.s. Input Voltage (at Ta=55°C)

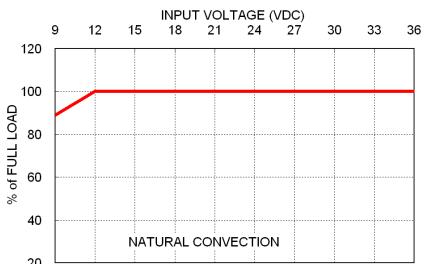

PDL09-24D12WM Load Derating v.s. Input Voltage (at Ta=60°C)

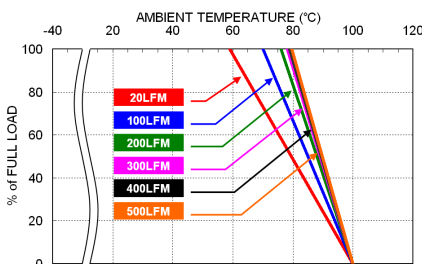

PDL09-24D12W Derating Curve

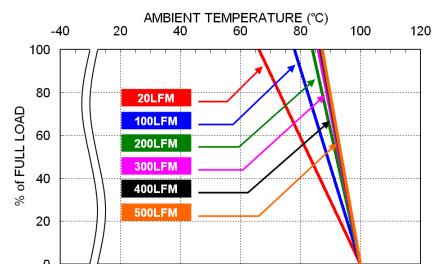

PDL09-24D12WM Derating Curve

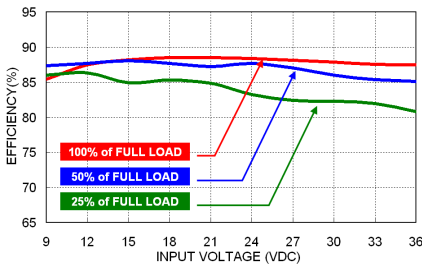

PDL09-24D12W Efficiency vs. Input Voltage

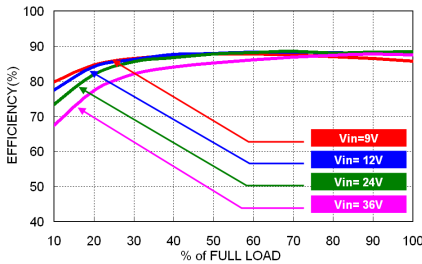

PDL09-24D12W Efficiency vs. Output Load

## FUSE CONSIDERATION

This power module is not internally fused. An input line fuse must always be used.

This encapsulated power module can be used in a wide variety of applications, ranging from simple stand-alone operation to an integrated part of sophisticated power architecture.

To maximum flexibility, internal fusing is not included; however, to achieve maximum safety and system protection, always use an input line fuse.

The input line fuse suggest as below :

Model	Fuse Rating (A)	Fuse Type
PDL09-24S□□W、PDL09-24D□□W	3.15	Slow-Blow
PDL09-48S□□W、PDL09-48D□□W	1.25	Slow-Blow

The table based on the information provided in this data sheet on inrush energy and maximum DC input current at low Vin.

## MECHANICAL DRAWING

### Standard type Metal Case

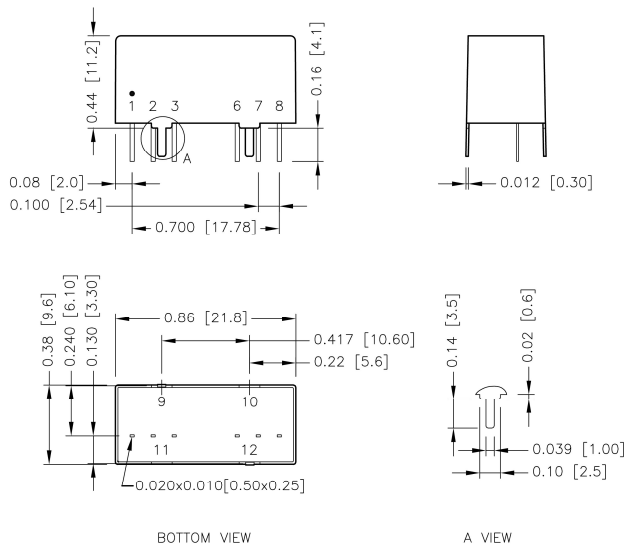

### PIN CONNECTION

PIN	SINGLE	DUAL
1	-Vin	-Vin
2	+Vin	+Vin
3	Ctrl	Ctrl
6	+Vout	+Vout
7	-Vout	Common
8	NC	-Vout
9	Case	Case
10	Stand off	Stand off
11	Stand off	Stand off
12	Case	Case

- All dimensions in inch [mm]  
 Tolerance :x.xx±0.02 [x.x±0.5]  
 x.xxx±0.01 [x.xx±0.25]
- Pin pitch tolerance ±0.01 [0.25]
- Pin dimension tolerance ±0.004[0.10]

### Plastic Case

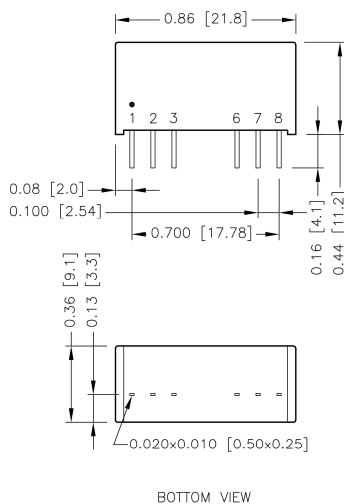

### PIN CONNECTION

PIN	SINGLE	DUAL
1	-Vin	-Vin
2	+Vin	+Vin
3	Ctrl	Ctrl
6	+Vout	+Vout
7	-Vout	Common
8	NC	-Vout

- All dimensions in inch [mm]  
 Tolerance :x.xx±0.02 [x.x±0.5]  
 x.xxx±0.01 [x.xx±0.25]
- Pin pitch tolerance ±0.01 [0.25]
- Pin dimension tolerance ±0.004[0.10]

**RECOMMENDED PAD LAYOUT**

**Standard type Metal Case**

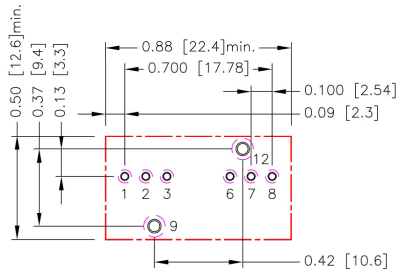

All dimensions in inch[mm]  
 Pad size(lead free recommended)  
 Through hole 1.2.3.6.7.8:  $\Phi 0.031[\Phi 0.80]$   
 Through hole 9.12:  $\Phi 0.051[\Phi 1.30]$   
 Top view pad 1.2.3.6.7.8:  $\Phi 0.039[\Phi 1.00]$   
 Top view pad 9.12:  $\Phi 0.064[\Phi 1.63]$   
 Bottom view pad 1.2.3.6.7.8:  $\Phi 0.063[\Phi 1.60]$   
 Bottom view pad 9.12:  $\Phi 0.102[\Phi 2.60]$

**Plastic Case**

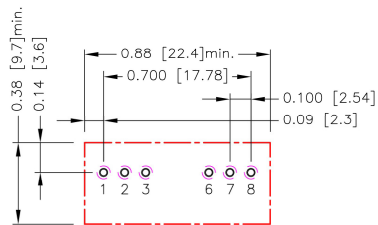

All dimensions in inch[mm]  
 Pad size(lead free recommended)  
 Through hole 1.2.3.6.7.8:  $\Phi 0.031[\Phi 0.80]$   
 Top view pad 1.2.3.6.7.8:  $\Phi 0.039[\Phi 1.00]$   
 Bottom view pad 1.2.3.6.7.8:  $\Phi 0.063[\Phi 1.60]$

**THERMAL CONSIDERATIONS**

The power module operates in a variety of thermal environments. However, sufficient cooling should be provided to help ensure reliable operation of the unit. Heat is removed by conduction, convection, and radiation to the surrounding Environment. Proper cooling can be verified by measuring the point as the figure below. The temperature at this location should not exceed 100°C. When Operating, adequate cooling must be provided to maintain the test point temperature at or below 100°C. Although the maximum point Temperature of the power modules is 100°C, you can limit this Temperature to a lower value for extremely high reliability.

- Thermal test condition with vertical direction by natural convection (20LFM).

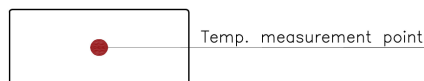

TOP VIEW