

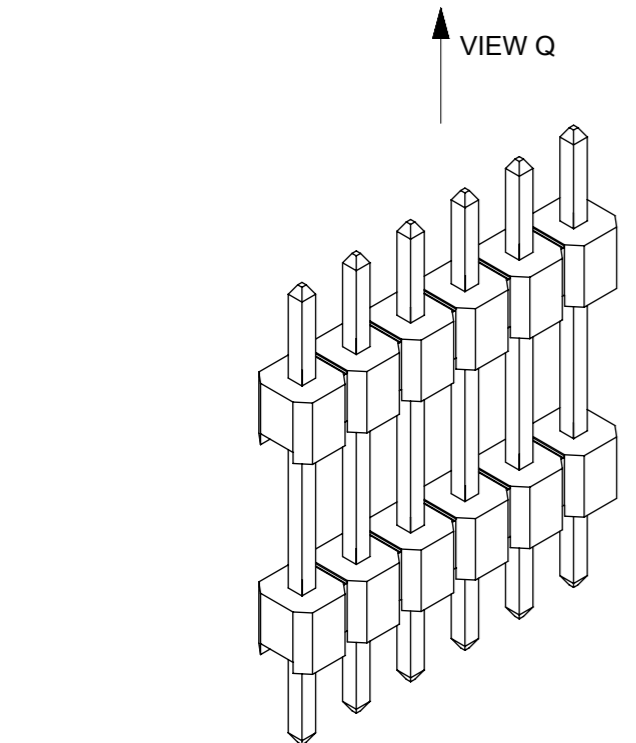

RECOMMENDED PCB HOLE LAYOUT

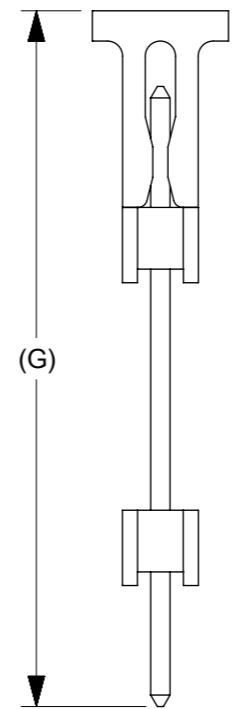
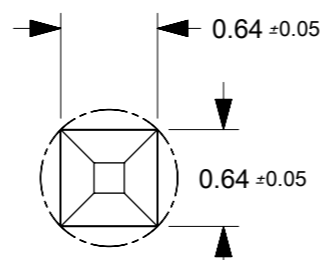
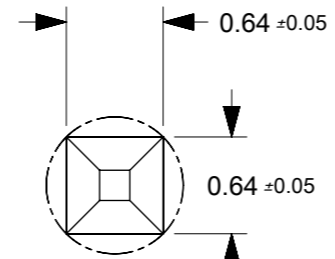
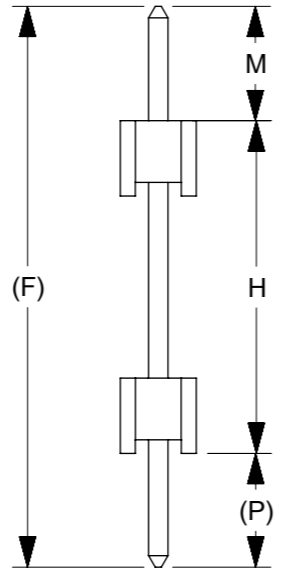
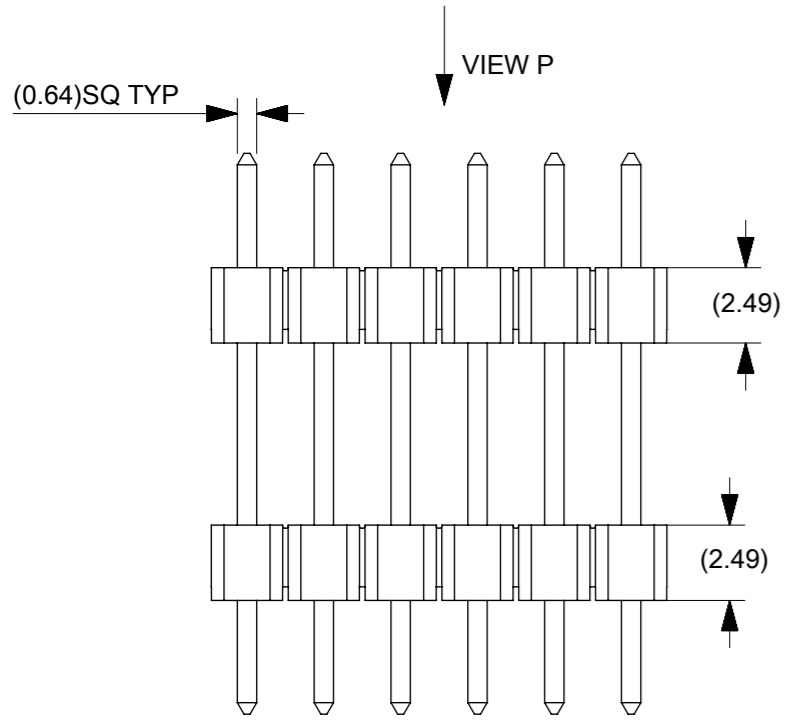

- NOTES:
- MATERIAL:  
HOUSING: NYLON, GLASS FILLED, UL94V-0,  
COLOR: BLACK  
TERMINAL: 0.64MM SQ PIN, COPPER ALLOY
  - PLATING TYPE:  
(1) : GOLD FLASH OVER  
1.25µm MIN. NICKEL OVERALL.  
(2) : 0.05 µm MIN. GOLD PLATE ON CONTACT AND  
2.50 µm MIN. TIN ON SOLDER TAIL OVER  
1.25 µm MIN. NICKEL OVERALL.  
(3) : 0.38 µm MIN. GOLD PLATE ON CONTACT AND  
2.00 µm MIN. TIN ON SOLDER TAIL OVER  
1.25 µm MIN. NICKEL OVERALL.  
(4) : 0.75 µm MIN. GOLD PLATE ON CONTACT AND  
2.00 µm MIN. TIN ON SOLDER TAIL OVER  
1.25 µm MIN. NICKEL OVERALL.  
(5) : 2.50 µm MIN. TIN OVER  
1.25 µm MIN. NICKEL OVERALL.  
(6) : 0.75 µm MIN. GOLD PLATE ON CONTACT AND  
SOLDER TAIL OVER 1.25 µm MIN. NICKEL OVERALL.
  - THE ABOVE 6 CKT IS FOR ILLUSTRATION PURPOSE ONLY.
  - PACKAGING TYPE: SEE TABLE
  - RECOMMENDED PCB THICKNESS 1.60MM.
  - PRODUCT SPECIFICATION: PS-87920-019
  - WAFER TO BE FLAT WITHIN 0.003mm/mm  
IRREGULAR CIRCUIT CUTOFF WITHIN BREAKAWAY SECTION
  - IS PERMISSIBLE. CUTTING OR CHIPPING OF THE MAIN BODY IS NOT ACCEPTABLE.
  - PARTS ARE NOT STACKABLE ON 2.54 CENTER
  - PACKAGING SPECIFICATION: SEE TABLE

THIS DRAWING CONTAINS INFORMATION THAT IS PROPRIETARY TO MOLEX ELECTRONIC TECHNOLOGIES, LLC AND SHOULD NOT BE USED WITHOUT WRITTEN PERMISSION									
DIMENSION UNITS		SCALE		CURRENT REV DESC: P/N 87937-1004 ADD				<b>molex</b>	
mm		NTS							
GENERAL TOLERANCES (UNLESS SPECIFIED)				EC NO: 624412				CUSTOM HEADER	
				DRWN: VNANDAM 2019/09/18				2.54MM PITCH SINGLE ROW DUAL WAFER HEADER, T/H	
4 PLACES ±				CHK'D: MRAMAKRISHNA 2019/09/20				PRODUCT CUSTOMER DRAWING	
3 PLACES ±				APPR: MRAMAKRISHNA 2019/09/20					
2 PLACES ± 0.2				INITIAL REVISION:				DOCUMENT NUMBER	
1 PLACE ±				DRWN: SKLIM01 2006/03/10				SD-87937-007	
0 PLACES ±				APPR: MLONG 2010/01/14				DOC TYPE DOC PART REVISION	
ANGULAR TOL ± 3.0°				DRAFT WHERE APPLICABLE MUST REMAIN WITHIN DIMENSIONS		THIRD ANGLE PROJECTION		MATERIAL NUMBER CUSTOMER SHEET NUMBER	
P1		RELEASE DATE 2019/09/20 12:14:39		A3-SIZE		87937		SEE TABLE GENERAL MARKET 1 OF 2	

F	PART NUMBERS	CKT SIZE	VOID POSITION	DIMENSION						PLATING OPTION	PACKAGING TYPE	PACKAGING SPECIFICATION	
						MATING END	STACKER HEIGHT	SOLDER TAIL					WITH CAP
				A	B	M	H	(P)	(F)				(G)
	879370106	1	----	2.54	----	3.78	11.00	3.76	18.54	----	5	TRAY PACKED	PK-89990-489
	879370202	2	----	5.08	2.54	3.50	25.00	3.50	32.00	----	5	TRAY PACKED	PK-89990-489
	879370203	2	----	5.08	2.54	2.45	15.60	2.45	20.50	----	5	BULK PACKED	PK-89990-491
	879370206	2	----	5.08	2.54	3.78	11.00	3.76	18.54	----	5	TRAY PACKED	PK-89990-489
	879370302	3	----	7.62	5.08	11.70	8.50	11.70	31.90	----	5	TRAY PACKED	PK-89990-489
	879370306	3	----	7.62	5.08	10.50	20.80	3.00	34.30	35.50	3	TUBE PACKED	PK-89990-***
	879370311	3	----	7.62	5.08	3.00	6.00	3.00	12.00	----	5	TRAY PACKED	PK-89990-489
	879370303	3	----	7.62	5.08	2.40	5.80	2.40	10.60	----	5	BULK PACKED	PK-89990-491
	879370304	3	----	7.62	5.08	4.00	12.50	4.00	20.50	----	5		
	879370305	3	----	7.62	5.08	3.00	7.00	3.00	13.00	----	5	TUBE PACKED	TBD
	879370306	3	----	7.62	5.08	10.50	20.80	3.00	34.30	35.50	3	TUBE PACKED	TBD
	879370307	3	----	7.62	5.08	2.40	17.50	3.00	22.90	27.00	5	TAPE & REEL	TBD
	879370309	3	----	7.62	5.08	6.00	9.00	3.00	18.00	----	5	TRAY PACKED	PK-89990-489
	879370406	4	----	10.16	7.62	3.78	11.00	3.76	18.54	----	5	TRAY PACKED	PK-89990-489
	879370402	4	----	10.16	7.62	2.65	11.50	2.41	16.56	----	3	TRAY PACKED	PK-89990-489
	879370502	5	----	12.70	10.16	3.78	11.00	3.76	18.54	----	5	TRAY PACKED	PK-89990-489
	879370503	5	----	12.70	10.16	4.00	12.50	4.00	20.50	----	5	BULK PACKED	PK-89990-491
	879370504	5	----	12.70	10.16	11.00	25.00	2.50	38.50	----	3	TRAY PACKED	PK-89990-489
	879370505	5	----	12.70	10.16	6.00	11.80	2.40	20.20	----	3	TRAY PACKED	PK-89990-489
	879370602	6	----	15.24	12.70	3.00	8.90	3.00	14.90	----	5	TRAY PACKED	PK-89990-489
	879370701	7	----	17.78	15.24	8.80	22.19	2.79	33.78	----	2	TRAY PACKED	PK-89990-489
	879370800	8	----	20.32	17.78	9.00	12.00	3.00	24.00	----	5	TRAY PACKED	PK-89990-489
	879370802	8	----	20.32	17.78	3.78	11.00	3.76	18.54	----	5	TRAY PACKED	PK-89990-489
	879370803	8	----	20.32	17.78	3.00	8.90	3.00	14.90	18.40	5	TAPE & REEL	TBD
	879371000	10	----	25.40	22.86	8.15	25.00	3.05	36.20	----	3	TRAY PACKED	PK-89990-489
	879371004	10	----	25.40	22.86	8.00	17.80	5.20	31.00	----	3	TRAY PACKED	PK-89990-489
	879371206	12	----	30.48	27.94	3.78	11.00	3.76	18.54	----	5	TRAY PACKED	PK-89990-489
	879371406	14	----	35.56	33.02	3.78	11.00	3.76	18.54	----	5	TRAY PACKED	PK-89990-489
	879371600	16	----	40.64	38.10	12.70	17.63	5.99	36.32	----	3	BULK PACKED	PK-89990-491
	879371601	16	----	40.64	38.10	11.94	19.05	2.79	33.78	----	3	BULK PACKED	PK-89990-491
	879371602	16	----	40.64	38.10	2.14	8.70	2.16	13.00	----	5	BULK PACKED	PK-89990-491
	879371606	16	----	40.64	38.10	3.78	11.00	3.76	18.54	----	5	TRAY PACKED	PK-89990-489
	879371801	18	----	45.72	43.18	3.00	13.20	3.00	19.20	----	5	TBD	----
	879372800	28	----	71.12	68.58	4.00	12.50	4.00	20.50	----	5	BULK PACKED	PK-89990-491

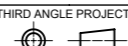
THIS DRAWING CONTAINS INFORMATION THAT IS PROPRIETARY TO MOLEX ELECTRONIC TECHNOLOGIES, LLC AND SHOULD NOT BE USED WITHOUT WRITTEN PERMISSION											
DIMENSION UNITS		SCALE		CURRENT REV DESC: P/N 87937-1004 ADD							
mm		NTS		 <p>CUSTOM HEADER 2.54MM PITCH SINGLE ROW DUAL WAFER HEADER, T/H</p>							
GENERAL TOLERANCES (UNLESS SPECIFIED)											
		MM	INCH	EC NO: 624412 DRWN: VNANDAM 2019/09/18 CHK'D: MRAMAKRISHNA 2019/09/20 APPR: MRAMAKRISHNA 2019/09/20							
4 PLACES	±	±	±								
3 PLACES	±	±	±	PRODUCT CUSTOMER DRAWING INITIAL REVISION: DRWN: SKLIM01 2006/03/10 APPR: MLONG 2010/01/14							
2 PLACES	±	0.2	±								
1 PLACE	±	±	±	DOCUMENT NUMBER		DOC TYPE	DOC PART	REVISION	SD-87937-007 PSD 000 B5		
0 PLACES	±	±	±	MATERIAL NUMBER		CUSTOMER		SHEET NUMBER			
ANGULAR TOL ± 3.0°				DRAFT WHERE APPLICABLE MUST REMAIN WITHIN DIMENSIONS		THIRD ANGLE PROJECTION		DRAWING	SERIES	SEE TABLE	
						A3-SIZE		87937	GENERAL MARKET		2 OF 2