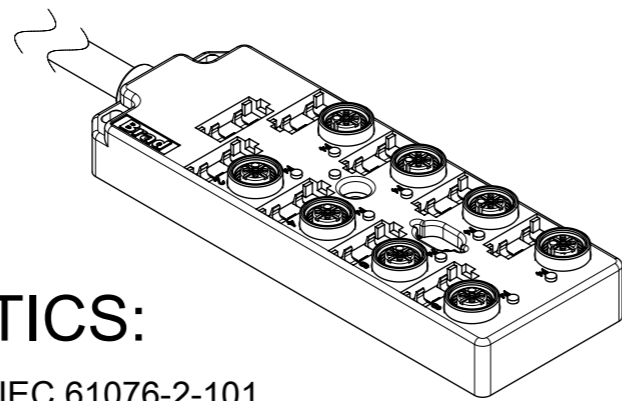
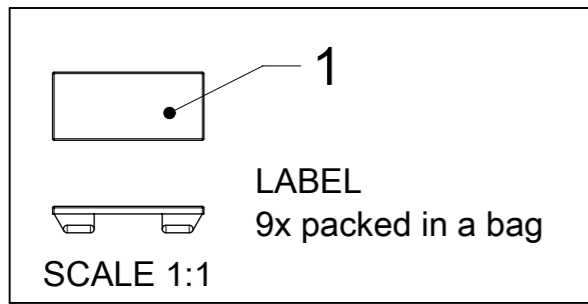
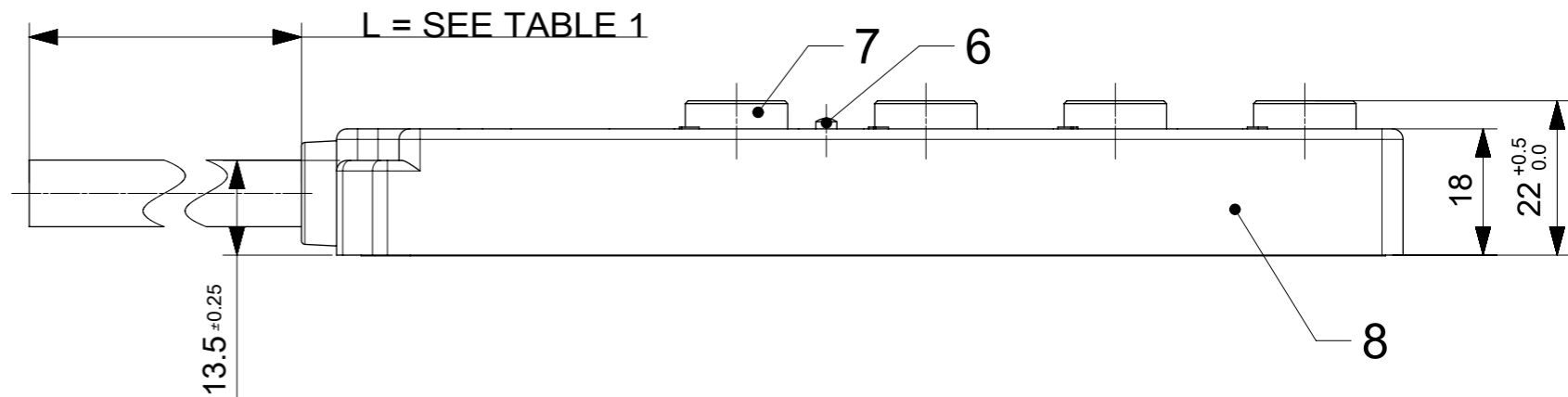
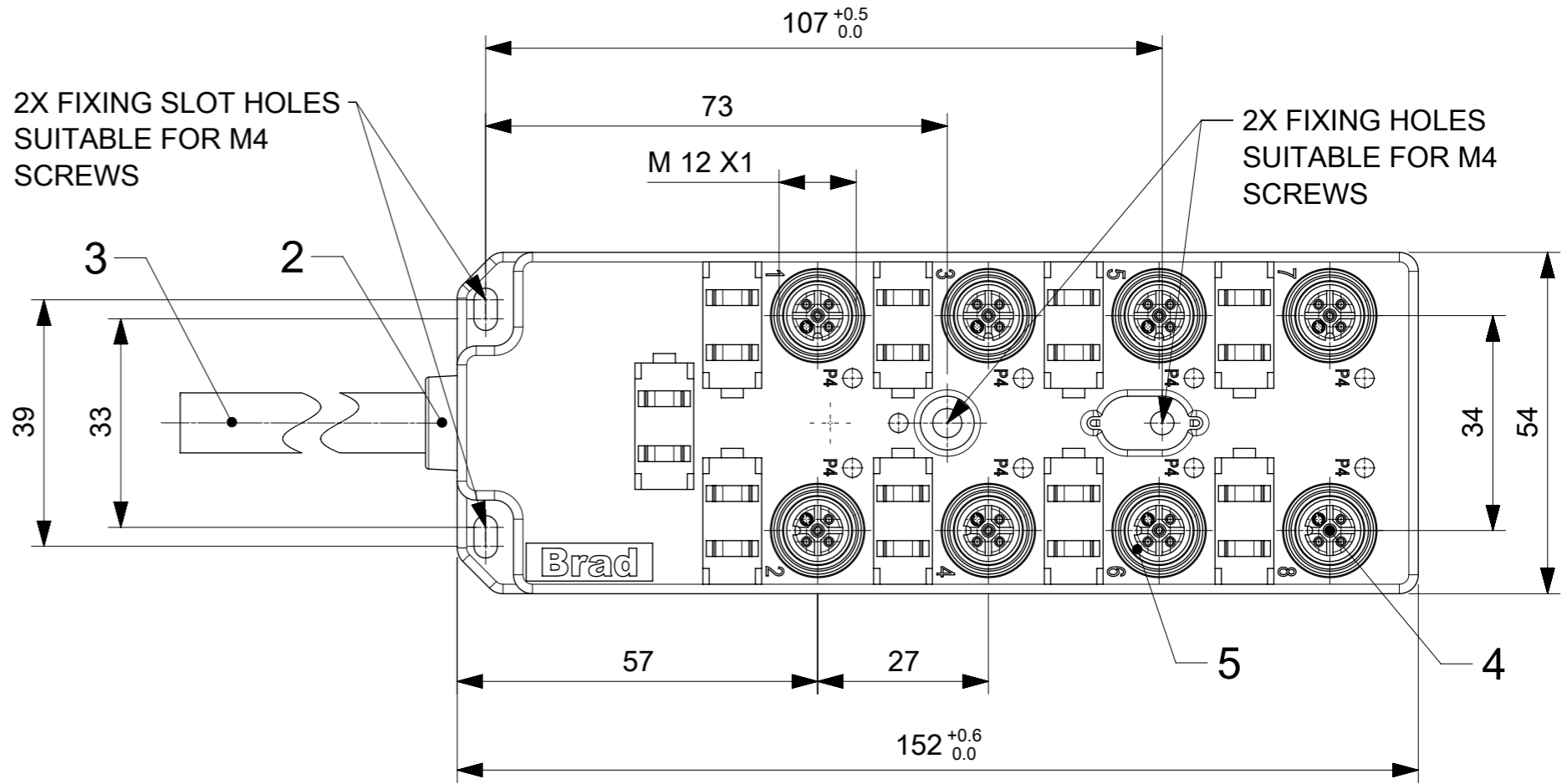

TABLE 1

MOLEX P/N	ENG. NO.	CABLE LENGTH (mm)	LED
1202480019	BTB8000-FBW-05	5000	NO
1202480020	BTB8000-FBW-10	10000	NO
1202480021	BTB8000-FBW-15	15000	NO
1202480022	BTB800P-FBW-05	5000	YES
1202480023	BTB800P-FBW-10	10000	YES
1202480024	BTB800P-FBW-15	15000	YES
1202480025	BTB800N-FBW-05	5000	YES
1202480026	BTB800N-FBW-10	10000	YES
1202480027	BTB800N-FBW-15	15000	YES

TABLE 2 BILL OF MATERIAL

ITEM	DESCRIPTION	MATERIAL	FINISH
1	LABEL	ABS	WHITE
2	CABLE PLATE	PBT	BLACK
3	CABLE	TPU BASED	BLACK
4	CONTACT	BRONZE	GOLD OVER NICKEL
5	O-RING	FPM	RED
6	LED	NO LED = PA	BLACK
		WITH LED = PA	TRANSPARENT
7	SHELL	BRASS	NICKEL PLATED
8	HOUSING	PBT	BLACK



GENERAL CHARACTERISTICS:

ELECTRICAL AND MECHANICAL DATA ACC. TO IEC 61076-2-101

NOMINAL VOLTAGE: 10-30 V DC
 AMPERE RATING: 4 A PER PORT / 12 A MAX
 AMPERE RATING WITH UL REGISTRATION: 3 A PER PORT / 9 A MAX
 IP DEGREE OF PROTECTION: IP 67
 TEMPERATURE RANGE: -25°C to + 85°C

THIS DRAWING CONTAINS INFORMATION THAT IS PROPRIETARY TO MOLEX INCORPORATED AND SHOULD NOT BE USED WITHOUT WRITTEN PERMISSION

EC DESCRIPTION EC NO: 120547 DRWN: ULETTENMEIER 2017/08/10 CHK'D: APPR: RSILLER 2017/08/23	QUALITY SYMBOLS	GENERAL TOLERANCES (UNLESS SPECIFIED)	DIMENSION UNITS	SCALE	
	▽ = 0 ▽ = 0 ▽ = 0 ▽ = 0 ▽ = 0 ▽ = 0 ▽ = 0 ▽ = 0	ANGULAR TOL ± ° 4 PLACES ± 3 PLACES ± 2 PLACES ± 1 PLACE ± 0 PLACES ± 0.25	mm	1:1	
	DRWN BY: AAHLERS DATE: 2015/04/01 CHK'D BY: DATE:	DRAFT WHERE APPLICABLE MUST REMAIN WITHIN DIMENSIONS	THIRD ANGLE PROJECTION	PRODUCT CUSTOMER DRAWING	
	APPR BY: RSILLER DATE: 2015/05/20	DRAWING SIZE: A3	SERIES: 120248 MATERIAL NUMBER: SEE TABLE 1 CUSTOMER: GENERAL MARKET	DOCUMENT NUMBER: 1202480019 DOC TYPE: PSD DOC PART: 000 SHEET NUMBER: 1 OF 2	

Wiring Diagram NON LED Single

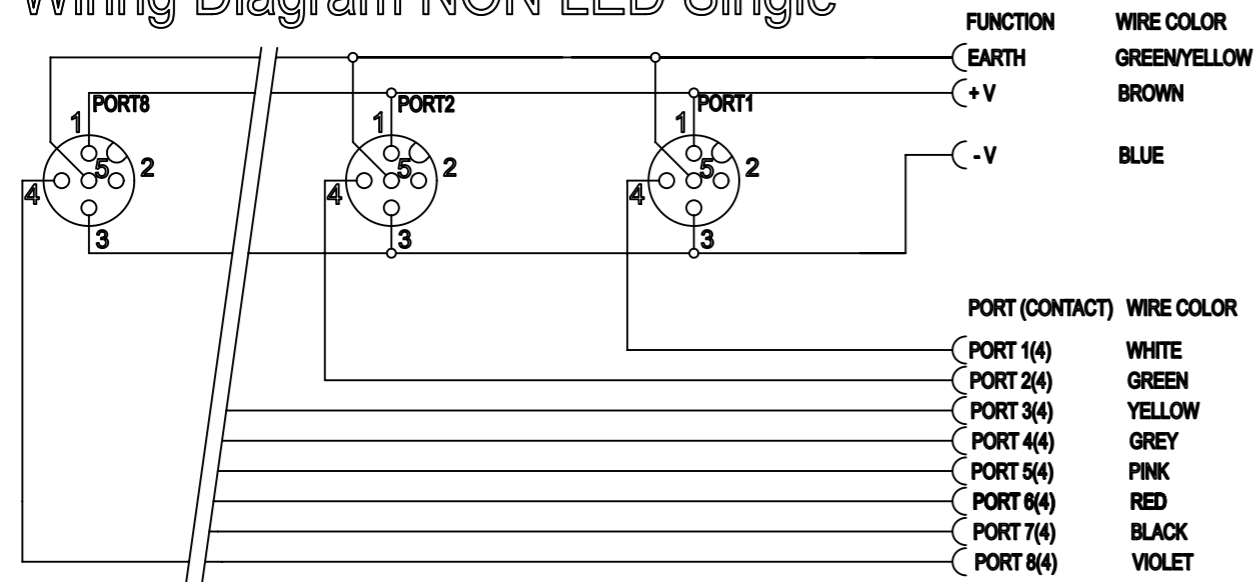

Wiring Diagram PNP Single

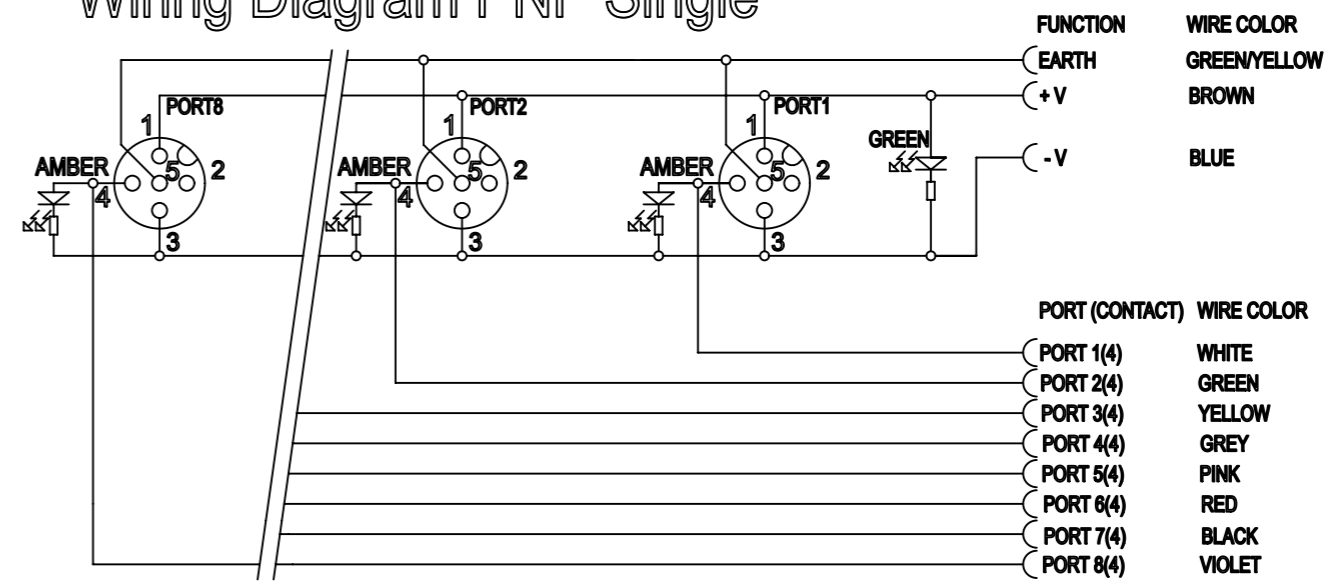

Wiring Diagram NPN Single

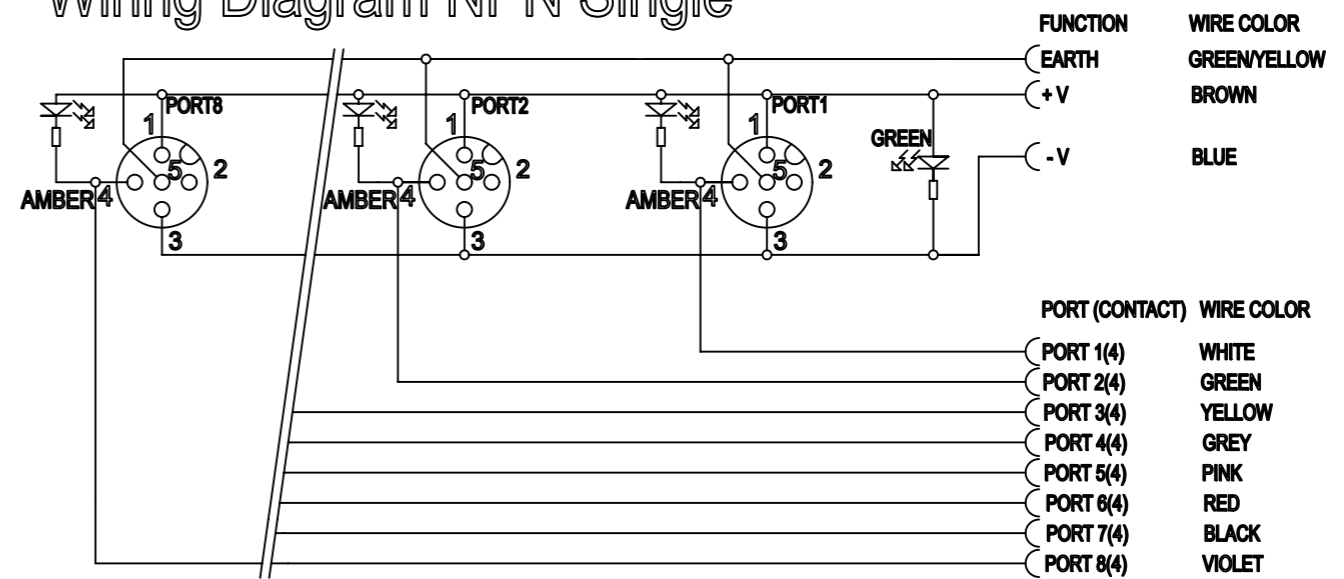

THIS DRAWING CONTAINS INFORMATION THAT IS PROPRIETARY TO MOLEX INCORPORATED AND SHOULD NOT BE USED WITHOUT WRITTEN PERMISSION

EC DESCRIPTION EC NO: 120547 DRWN: ULETTENMEIER 2017/08/10 CHK'D: APPR: RSILLER 2017/08/23	QUALITY SYMBOLS	GENERAL TOLERANCES (UNLESS SPECIFIED) ANGULAR TOL ± ° 4 PLACES ± 3 PLACES ± 2 PLACES ± 1 PLACE ± 0 PLACES ± 0.25 DRAFT WHERE APPLICABLE MUST REMAIN WITHIN DIMENSIONS	DIMENSION UNITS	SCALE			
	= 0 = 0 = 0 = 0 = 0 = 0 = 0 = 0		mm	1:1			
	DRWN BY AAHLERS		DATE	2015/04/01			
	APPR BY RSILLER		DATE	2015/05/20			
EC NO: 120547 DRWN: ULETTENMEIER 2017/08/10 CHK'D: APPR: RSILLER 2017/08/23	EC DESCRIPTION EC NO: 120547 DRWN: ULETTENMEIER 2017/08/10 CHK'D: APPR: RSILLER 2017/08/23	DIMENSION UNITS mm	SCALE 1:1	MPIS M12 PNP NPN NOS 4P 8PT AC FE STR BK XM STA SINGLE			
EC NO: 120547 DRWN: ULETTENMEIER 2017/08/10 CHK'D: APPR: RSILLER 2017/08/23	EC DESCRIPTION EC NO: 120547 DRWN: ULETTENMEIER 2017/08/10 CHK'D: APPR: RSILLER 2017/08/23	DIMENSION UNITS mm	SCALE 1:1	PRODUCT CUSTOMER DRAWING			
EC NO: 120547 DRWN: ULETTENMEIER 2017/08/10 CHK'D: APPR: RSILLER 2017/08/23	EC DESCRIPTION EC NO: 120547 DRWN: ULETTENMEIER 2017/08/10 CHK'D: APPR: RSILLER 2017/08/23	DIMENSION UNITS mm	SCALE 1:1	SERIES 120248	MATERIAL NUMBER SEE TABLE 1	CUSTOMER GENERAL MARKET	
EC NO: 120547 DRWN: ULETTENMEIER 2017/08/10 CHK'D: APPR: RSILLER 2017/08/23	EC DESCRIPTION EC NO: 120547 DRWN: ULETTENMEIER 2017/08/10 CHK'D: APPR: RSILLER 2017/08/23	DIMENSION UNITS mm	SCALE 1:1	DOCUMENT NUMBER 1202480019	DOC TYPE PSD	DOC PART 000	SHEET NUMBER 2 OF 2