

# Pushbutton Switches/Selector Switches/Indicators A22N/M22N/A30N

Control panel miniaturization through a more compact design and modified wiring direction  
 Addition of Push-In Plus terminal blocks for easy wiring  
 Workability and safety improvements

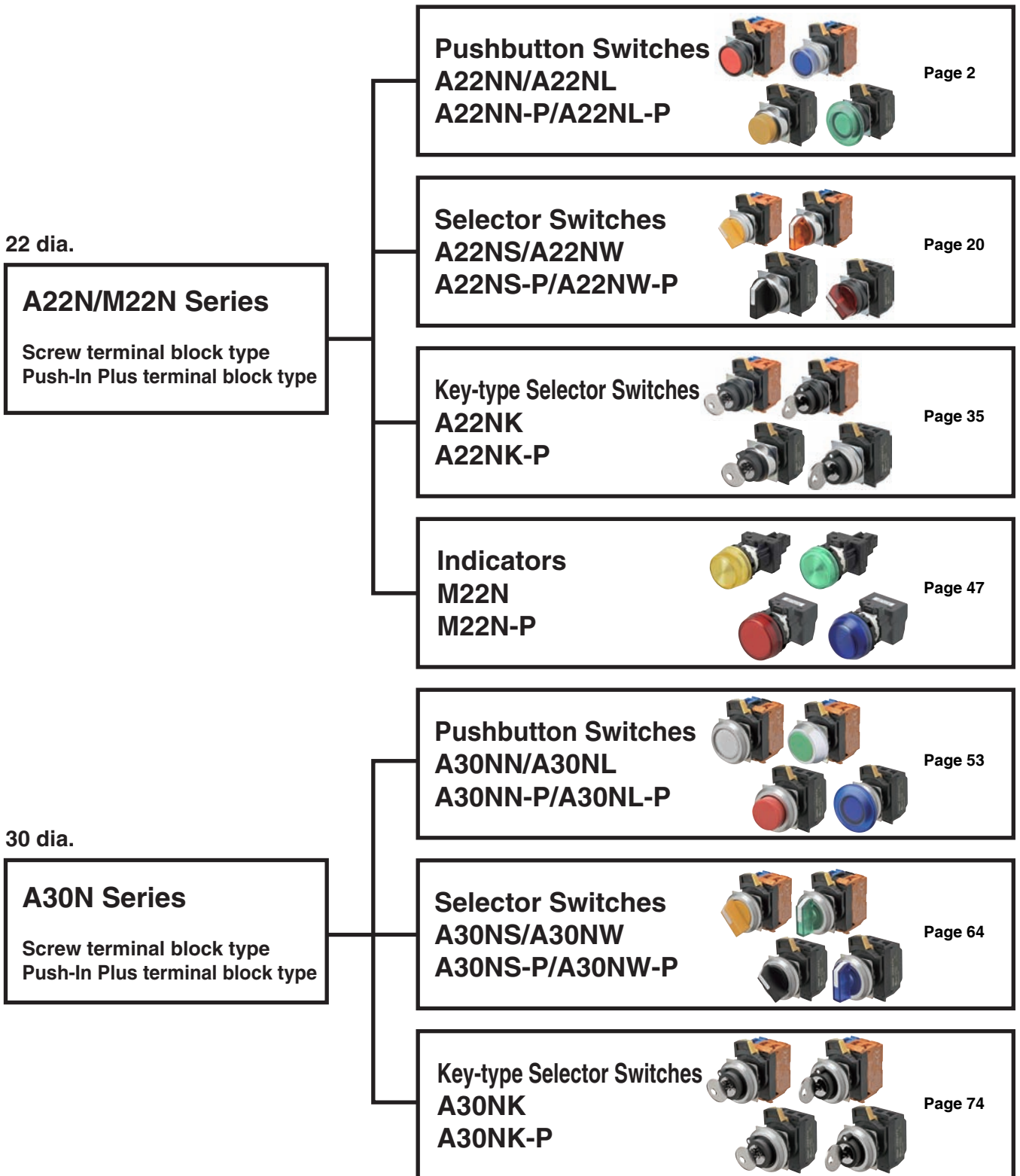

# Pushbutton Switches A22NN/A22NL

**22-mm dia. Pushbutton Switches**  
**Control panel miniaturization through a more compact design and modified wiring direction.**  
**Addition of Push-In Plus terminal blocks for easy wiring.**



### Easy to Use

- Improved wiring visibility through to a modified wiring direction. (Push-In Plus terminal block type)
- Screw terminal block structure is compatible with round crimp terminals. (Screw terminal block type)
- The terminals can be secured even when a contact block is mounted. (Screw terminal block type)
- Contact Blocks can be attached in any direction for easy assembly.

### Miniaturization

- No need for extra lateral space because of the modified wiring direction. (Push-In Plus terminal block type)
- Compact design.
- A22NL (lighted models) are the same size as A22NN (non-lighted models).

### Safety

- Easy-to-operate lock lever for secure locking.
- Easy-mounting Contact Blocks provide finger protection.
- No loose connections of wiring means maintenance-free use. (Push-In Plus terminal block type)

### Product Lineup

- Meet global safety standards.
- Can be installed in two types of panel hole dimensions: 22.3 and 25.5 dia.
- The buttons and bezels come in a wide variety of colors, shapes, and materials.
- Standard-feature degree of protection: IP66, NEMA 4X, and NEMA 13.

Refer to *Safety Precautions for All Pushbutton Switches/Indicators and Safety Precautions* on page 88.

## Button Colors

		Red	Green	Yellow	White	Blue	Black		
Non-lighted Switches	A22NN-□□□-N□ Opaque								
	A22NN-□□□-U□ Transparent								
Lighted Switches	A22NL-□□□-T□ Transparent	When not lit							
		When lit							
	A22NL-□□□-T□ Transparent	When not lit							
		When lit							

\* The colors when the Switches are lit are for transparent white buttons (code: TW) and yellow LED Lamps (code: Y).

Pushbutton Switches  
A22N

Selector Switches  
A22N

Key-Type Selector Switches  
A22N

Indicators  
M22N

Pushbutton Switches  
A30N

Selector Switches  
A30N





Key-Type Selector Switches  
A30N

Subassemblies  
(Common)

Accessories  
and Tools

Safety  
Precautions

# List of Models

Screw Terminal Blocks/Push-In Plus Terminal Blocks		
Plastic bezels	Brushed metal bezels	Metal bezels
A22N□-BN	A22N□-MN	A22N□-RN
<p>Flat</p> 	<p>Flat</p> 	<p>Flat</p> 
A22N□-BP	A22N□-MP	A22N□-RP
<p>Projected</p> 	<p>Projected</p> 	<p>Projected</p> 
A22N□-BG	A22N□-MG	
<p>Full guard</p> 	<p>Full guard</p> 	
A22N□-BM	A22N□-MM	A22N□-RM
<p>Mushroom</p> 	<p>Mushroom</p> 	<p>Mushroom</p> 

Pushbutton Switches  
A22N

Selector Switches  
A22N

Key-type Selector Switches  
A22N

Indicators  
M22N

Pushbutton Switches  
A30N

Selector Switches  
A30N

Key-type Selector Switches  
A30N

Subassemblies  
(Common)

Accessories  
and Tools

Safety  
Precautions

# A22NN/A22NL

## Model Number Structure

### Model Number Legend

----- Shipped as a set that includes the Operation Unit, LED Lamp (lighted models only), Mounting Collar, Contact Block, and Lighting Unit (lighted models only).

For information on combinations, refer to *Ordering Information* on pages 5 to 8.

### Model Numbers for Sets

A 2 2 N <sup>(1)</sup> L - <sup>(2)</sup> B N <sup>(3)</sup> M - <sup>(4)</sup> T R <sup>(5)</sup> A - <sup>(6)</sup> G <sup>(7)</sup> 1 0 0 - <sup>(8)</sup> R <sup>(9)</sup> B

#### (1) Type

Code	Description
N	Non-lighted
L	Lighted

#### (2) Bezel Material and Button Shape

Code	Bezel material	Button shape
BN	Plastic	Flat
BP	Plastic	Projected
BG	Plastic	Full guard
BM	Plastic	Mushroom
MN	Brushed metal	Flat
MP	Brushed metal	Projected
MG	Brushed metal	Full guard
MM	Brushed metal	Mushroom
RN	Metal	Flat
RP	Metal	Projected
RM	Metal	Mushroom

#### (3) Switch Action

Code	Description
M	Momentary
A	Alternate

#### (4) Button Transparency and Color and (8) LED Lamp Color

Lighted/non-lighted	Code (4)	Code (8)	Transparency	Button color	LED lamp color
Non-lighted	NR	N	Opaque	Red	---
	NG	N	Opaque	Green	
	NY	N	Opaque	Yellow	
	NW	N	Opaque	White	
	NA	N	Opaque	Blue	
	NB	N	Opaque	Black	
	UR	N	Transparent	Red	
	UG	N	Transparent	Green	
	UY	N	Transparent	Yellow	
	UW	N	Transparent	White	
	UA	N	Transparent	Blue	
	UO	N	Transparent	Orange	
Lighted	TR	R	Transparent	Red	Red
	TG	G	Transparent	Green	Green
	TY	Y	Transparent	Yellow	Yellow
	TW	W	Transparent	White	White
	TA	A	Transparent	Blue	Blue
	TO	O	Transparent	Orange	Orange
	TW	Y	Transparent	White *	Yellow

\* The color is opaque white when the Switch is lit.

#### (5) Degree of Protection

Code	Description
A	Conforming to IP66, NEMA 4X, NEMA13

#### (6) Contacts and Terminals Specifications

Code	Specification
G	General/Screw terminal block
P	General/Push-In Plus Terminal Block

#### (7) Contacts

Code	Contact Blocks		Unit position					
			Non-lighted			Lighted		
	NO	NC	1	2	3	1	2	3
100	1	0	NO	---	---	NO	Lighting Unit	---
002	0	1	---	---	NC	---	Lighting Unit	NC
101	2	0	NO	---	NO	NO	Lighting Unit	NO
102	1	1	NO	---	NC	NO	Lighting Unit	NC
202	0	2	NC	---	NC	NC	Lighting Unit	NC
111	3	0	NO	NO	NO			
112	2	1	NO	NO	NC			
122	1	2	NO	NC	NC			
222	0	3	NC	NC	NC			

Note: 1. NO (blue): Normally open, NC (orange): Normally closed.

2. Refer to the following figure for Unit positions.

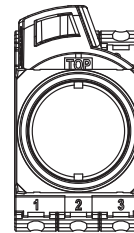

#### (9) LED Lamp Voltage

Code	LED Lamp voltage
N	Non-lighted
A	6 VAC/DC
B	12 VAC/DC
C	24 VAC/DC
D	100/110/120 VAC
E	200/220/230/240 VAC

■ Specifications: Refer to page 13.

■ Dimensions: Refer to pages 15 to 17.



■ Precautions for correct use: Refer to pages 88 to 99.

■ Accessories and tools: Refer to pages 84 to 85.



# Ordering Information

**Model Numbers for Sets** - - - Shipped as a set that includes the Operation Unit, LED Lamp (lighted models only), Mounting Collar, Contact Block, and Lighting Unit (lighted models only).

## Non-lighted, Flat Switches

Appearance	Contacts	Momentary action (self-resetting)	Alternate action (self-holding)	(4)(4) Button color	(7)(7)(7) Contacts	
		Model	Model			
	1	A22NN-BNM-(4)(4)A-G(7)(7)-NN	A22NN-BNA-(4)(4)A-G(7)(7)-NN	NR: Opaque, red NG: Opaque, green NY: Opaque, yellow NW: Opaque, white NA: Opaque, blue NB: Opaque, black UR: Transparent, red UG: Transparent, green UY: Transparent, yellow UW: Transparent, white UA: Transparent, blue UO: Transparent, orange	100 002	
		A22NN-BNM-(4)(4)A-P(7)(7)-NN	A22NN-BNA-(4)(4)A-P(7)(7)-NN			
	2	A22NN-BNM-(4)(4)A-G(7)(7)-NN	A22NN-BNA-(4)(4)A-G(7)(7)-NN		101 102 202	
		A22NN-BNM-(4)(4)A-P(7)(7)-NN	A22NN-BNA-(4)(4)A-P(7)(7)-NN			
	3	A22NN-BNM-(4)(4)A-G(7)(7)-NN	A22NN-BNA-(4)(4)A-G(7)(7)-NN		111 112 122 222	
		A22NN-BNM-(4)(4)A-P(7)(7)-NN	A22NN-BNA-(4)(4)A-P(7)(7)-NN			
	1	A22NN-MNM-(4)(4)A-G(7)(7)-NN	A22NN-MNA-(4)(4)A-G(7)(7)-NN		NR: Opaque, red NG: Opaque, green NY: Opaque, yellow NW: Opaque, white NA: Opaque, blue NB: Opaque, black UR: Transparent, red UG: Transparent, green UY: Transparent, yellow UW: Transparent, white UA: Transparent, blue UO: Transparent, orange	100 002
		A22NN-MNM-(4)(4)A-P(7)(7)-NN	A22NN-MNA-(4)(4)A-P(7)(7)-NN			
	2	A22NN-MNM-(4)(4)A-G(7)(7)-NN	A22NN-MNA-(4)(4)A-G(7)(7)-NN			101 102 202
		A22NN-MNM-(4)(4)A-P(7)(7)-NN	A22NN-MNA-(4)(4)A-P(7)(7)-NN			
	3	A22NN-MNM-(4)(4)A-G(7)(7)-NN	A22NN-MNA-(4)(4)A-G(7)(7)-NN			111 112 122 222
		A22NN-MNM-(4)(4)A-P(7)(7)-NN	A22NN-MNA-(4)(4)A-P(7)(7)-NN			
	1	A22NN-RNM-(4)(4)A-G(7)(7)-NN	A22NN-RNA-(4)(4)A-G(7)(7)-NN	NR: Opaque, red NG: Opaque, green NY: Opaque, yellow NW: Opaque, white NA: Opaque, blue NB: Opaque, black UR: Transparent, red UG: Transparent, green UY: Transparent, yellow UW: Transparent, white UA: Transparent, blue UO: Transparent, orange		100 002
		A22NN-RNM-(4)(4)A-P(7)(7)-NN	A22NN-RNA-(4)(4)A-P(7)(7)-NN			
	2	A22NN-RNM-(4)(4)A-G(7)(7)-NN	A22NN-RNA-(4)(4)A-G(7)(7)-NN			101 102 202
		A22NN-RNM-(4)(4)A-P(7)(7)-NN	A22NN-RNA-(4)(4)A-P(7)(7)-NN			
	3	A22NN-RNM-(4)(4)A-G(7)(7)-NN	A22NN-RNA-(4)(4)A-G(7)(7)-NN			111 112 122 222
		A22NN-RNM-(4)(4)A-P(7)(7)-NN	A22NN-RNA-(4)(4)A-P(7)(7)-NN			

## Lighted, Flat Switches

Appearance	Contacts	Momentary action (self-resetting)	Alternate action (self-holding)	(4)(4) Button color	(7)(7)(7) Contacts	(8) LED Lamp color	(9) LED Lamp voltage							
		Model	Model											
	1	A22NL-BNM-(4)(4)A-G(7)(7)-(8)(9)	A22NL-BNA-(4)(4)A-G(7)(7)-(8)(9)	TR: Transparent, red TG: Transparent, green TY: Transparent, yellow TW: Transparent, white TA: Transparent, blue TO: Transparent, orange	100 002	R: Red G: Green Y: Yellow W: White A: Blue O: Orange	A: 6 VAC/DC B: 12 VAC/DC C: 24 VAC/DC D: 100/110/120 VAC E: 200/220/230/240 VAC							
		A22NL-BNM-(4)(4)A-P(7)(7)-(8)(9)	A22NL-BNA-(4)(4)A-P(7)(7)-(8)(9)											
	2	A22NL-BNM-(4)(4)A-G(7)(7)-(8)(9)	A22NL-BNA-(4)(4)A-G(7)(7)-(8)(9)		101 102 202									
		A22NL-BNM-(4)(4)A-P(7)(7)-(8)(9)	A22NL-BNA-(4)(4)A-P(7)(7)-(8)(9)											
		1	A22NL-MNM-(4)(4)A-G(7)(7)-(8)(9)		A22NL-MNA-(4)(4)A-G(7)(7)-(8)(9)			TR: Transparent, red TG: Transparent, green TY: Transparent, yellow TW: Transparent, white TA: Transparent, blue TO: Transparent, orange	100 002	R: Red G: Green Y: Yellow W: White A: Blue O: Orange	A: 6 VAC/DC B: 12 VAC/DC C: 24 VAC/DC D: 100/110/120 VAC E: 200/220/230/240 VAC			
			A22NL-MNM-(4)(4)A-P(7)(7)-(8)(9)		A22NL-MNA-(4)(4)A-P(7)(7)-(8)(9)									
2		A22NL-MNM-(4)(4)A-G(7)(7)-(8)(9)	A22NL-MNA-(4)(4)A-G(7)(7)-(8)(9)		101 102 202									
		A22NL-MNM-(4)(4)A-P(7)(7)-(8)(9)	A22NL-MNA-(4)(4)A-P(7)(7)-(8)(9)											
		1	A22NL-RNM-(4)(4)A-G(7)(7)-(8)(9)		A22NL-RNA-(4)(4)A-G(7)(7)-(8)(9)				TR: Transparent, red TG: Transparent, green TY: Transparent, yellow TW: Transparent, white TA: Transparent, blue TO: Transparent, orange			100 002	R: Red G: Green Y: Yellow W: White A: Blue O: Orange	A: 6 VAC/DC B: 12 VAC/DC C: 24 VAC/DC D: 100/110/120 VAC E: 200/220/230/240 VAC
			A22NL-RNM-(4)(4)A-P(7)(7)-(8)(9)		A22NL-RNA-(4)(4)A-P(7)(7)-(8)(9)									
	2	A22NL-RNM-(4)(4)A-G(7)(7)-(8)(9)	A22NL-RNA-(4)(4)A-G(7)(7)-(8)(9)		101 102 202									
		A22NL-RNM-(4)(4)A-P(7)(7)-(8)(9)	A22NL-RNA-(4)(4)A-P(7)(7)-(8)(9)											

**Note:** Normally, the Button and LED Lamp with the same color are combined.  
 However, opaque white is available by combining a white Button and yellow LED. A22N□-□□□-TWA-□□□□-Y□

■ Subassemblies: Refer to pages 9 to 12 and 82.  
 (You can order Operation Units, LED Lamps, Mounting Collars, and Contact Blocks individually.)

■ Specifications: Refer to page 13.  
 ■ Dimensions: Refer to pages 15 to 17.  
 ■ Accessories and tools: Refer to pages 84 to 85.



Pushbutton Switches  
 A22N  
 Selector Switches  
 A22N  
 Key-type Selector Switches  
 A22N  
 Indicators  
 M22N  
 Pushbutton Switches  
 A30N  
 Selector Switches  
 A30N  
 Key-type Selector Switches  
 A30N  
 Subassemblies (Common)  
 Accessories and Tools  
 Safety Precautions

# A22NN/A22NL



## Ordering Information

**Model Numbers for Sets** - - - Shipped as a set that includes the Operation Unit, LED Lamp (lighted models only), Mounting Collar, Contact Block, and Lighting Unit (lighted models only).

### Non-lighted, Projected Switches

Appearance	Contacts	Momentary action (self-resetting)	Alternate action (self-holding)	(4)(4) Button color	(7)(7)(7) Contacts	
		Model	Model			
	1	A22NN-BPM-(4)(4)A-G(7)(7)(7)-NN	A22NN-BPA-(4)(4)A-G(7)(7)(7)-NN	<b>NR:</b> Opaque, red <b>NG:</b> Opaque, green <b>NY:</b> Opaque, yellow <b>NW:</b> Opaque, white <b>NA:</b> Opaque, blue <b>NB:</b> Opaque, black <b>UR:</b> Transparent, red <b>UG:</b> Transparent, green <b>UY:</b> Transparent, yellow <b>UW:</b> Transparent, white <b>UA:</b> Transparent, blue <b>UO:</b> Transparent, orange	100 002	
		A22NN-BPM-(4)(4)A-P(7)(7)(7)-NN	A22NN-BPA-(4)(4)A-P(7)(7)(7)-NN			
	2	A22NN-BPM-(4)(4)A-G(7)(7)(7)-NN	A22NN-BPA-(4)(4)A-G(7)(7)(7)-NN		101 102 202	
		A22NN-BPM-(4)(4)A-P(7)(7)(7)-NN	A22NN-BPA-(4)(4)A-P(7)(7)(7)-NN			
	3	A22NN-BPM-(4)(4)A-G(7)(7)(7)-NN	A22NN-BPA-(4)(4)A-G(7)(7)(7)-NN		111 112 122 222	
		A22NN-BPM-(4)(4)A-P(7)(7)(7)-NN	A22NN-BPA-(4)(4)A-P(7)(7)(7)-NN			
	1	A22NN-MPM-(4)(4)A-G(7)(7)(7)-NN	A22NN-MPA-(4)(4)A-G(7)(7)(7)-NN		<b>NR:</b> Opaque, red <b>NG:</b> Opaque, green <b>NY:</b> Opaque, yellow <b>NW:</b> Opaque, white <b>NA:</b> Opaque, blue <b>NB:</b> Opaque, black <b>UR:</b> Transparent, red <b>UG:</b> Transparent, green <b>UY:</b> Transparent, yellow <b>UW:</b> Transparent, white <b>UA:</b> Transparent, blue <b>UO:</b> Transparent, orange	100 002
		A22NN-MPM-(4)(4)A-P(7)(7)(7)-NN	A22NN-MPA-(4)(4)A-P(7)(7)(7)-NN			
	2	A22NN-MPM-(4)(4)A-G(7)(7)(7)-NN	A22NN-MPA-(4)(4)A-G(7)(7)(7)-NN			101 102 202
		A22NN-MPM-(4)(4)A-P(7)(7)(7)-NN	A22NN-MPA-(4)(4)A-P(7)(7)(7)-NN			
	3	A22NN-MPM-(4)(4)A-G(7)(7)(7)-NN	A22NN-MPA-(4)(4)A-G(7)(7)(7)-NN			111 112 122 222
		A22NN-MPM-(4)(4)A-P(7)(7)(7)-NN	A22NN-MPA-(4)(4)A-P(7)(7)(7)-NN			
	1	A22NN-RPM-(4)(4)A-G(7)(7)(7)-NN	A22NN-RPA-(4)(4)A-G(7)(7)(7)-NN	<b>NR:</b> Opaque, red <b>NG:</b> Opaque, green <b>NY:</b> Opaque, yellow <b>NW:</b> Opaque, white <b>NA:</b> Opaque, blue <b>NB:</b> Opaque, black <b>UR:</b> Transparent, red <b>UG:</b> Transparent, green <b>UY:</b> Transparent, yellow <b>UW:</b> Transparent, white <b>UA:</b> Transparent, blue <b>UO:</b> Transparent, orange		100 002
		A22NN-RPM-(4)(4)A-P(7)(7)(7)-NN	A22NN-RPA-(4)(4)A-P(7)(7)(7)-NN			
	2	A22NN-RPM-(4)(4)A-G(7)(7)(7)-NN	A22NN-RPA-(4)(4)A-G(7)(7)(7)-NN			101 102 202
		A22NN-RPM-(4)(4)A-P(7)(7)(7)-NN	A22NN-RPA-(4)(4)A-P(7)(7)(7)-NN			
	3	A22NN-RPM-(4)(4)A-G(7)(7)(7)-NN	A22NN-RPA-(4)(4)A-G(7)(7)(7)-NN			111 112 122 222
		A22NN-RPM-(4)(4)A-P(7)(7)(7)-NN	A22NN-RPA-(4)(4)A-P(7)(7)(7)-NN			

### Lighted, Projected Switches

Appearance	Contacts	Momentary action (self-resetting)	Alternate action (self-holding)	(4)(4) Button color	(7)(7)(7) Contacts	(8) LED Lamp color	(9) LED Lamp voltage							
		Model	Model											
	1	A22NL-BPM-(4)(4)A-G(7)(7)(7)-(8)(9)	A22NL-BPA-(4)(4)A-G(7)(7)(7)-(8)(9)	<b>TR:</b> Transparent, red <b>TG:</b> Transparent, green <b>TY:</b> Transparent, yellow <b>TW:</b> Transparent, white <b>TA:</b> Transparent, blue <b>TO:</b> Transparent, orange	100 002	<b>R:</b> Red <b>G:</b> Green <b>Y:</b> Yellow <b>W:</b> White <b>A:</b> Blue <b>O:</b> Orange	<b>A:</b> 6 VAC/DC <b>B:</b> 12 VAC/DC <b>C:</b> 24 VAC/DC <b>D:</b> 100/110/120 VAC <b>E:</b> 200/220/230/240 VAC							
		A22NL-BPM-(4)(4)A-P(7)(7)(7)-(8)(9)	A22NL-BPA-(4)(4)A-P(7)(7)(7)-(8)(9)											
	2	A22NL-BPM-(4)(4)A-G(7)(7)(7)-(8)(9)	A22NL-BPA-(4)(4)A-G(7)(7)(7)-(8)(9)		101 102 202									
		A22NL-BPM-(4)(4)A-P(7)(7)(7)-(8)(9)	A22NL-BPA-(4)(4)A-P(7)(7)(7)-(8)(9)											
		1	A22NL-MPM-(4)(4)A-G(7)(7)(7)-(8)(9)		A22NL-MPA-(4)(4)A-G(7)(7)(7)-(8)(9)			<b>TR:</b> Transparent, red <b>TG:</b> Transparent, green <b>TY:</b> Transparent, yellow <b>TW:</b> Transparent, white <b>TA:</b> Transparent, blue <b>TO:</b> Transparent, orange	100 002	<b>R:</b> Red <b>G:</b> Green <b>Y:</b> Yellow <b>W:</b> White <b>A:</b> Blue <b>O:</b> Orange	<b>A:</b> 6 VAC/DC <b>B:</b> 12 VAC/DC <b>C:</b> 24 VAC/DC <b>D:</b> 100/110/120 VAC <b>E:</b> 200/220/230/240 VAC			
			A22NL-MPM-(4)(4)A-P(7)(7)(7)-(8)(9)		A22NL-MPA-(4)(4)A-P(7)(7)(7)-(8)(9)									
2		A22NL-MPM-(4)(4)A-G(7)(7)(7)-(8)(9)	A22NL-MPA-(4)(4)A-G(7)(7)(7)-(8)(9)		101 102 202									
		A22NL-MPM-(4)(4)A-P(7)(7)(7)-(8)(9)	A22NL-MPA-(4)(4)A-P(7)(7)(7)-(8)(9)											
		1	A22NL-RPM-(4)(4)A-G(7)(7)(7)-(8)(9)		A22NL-RPA-(4)(4)A-G(7)(7)(7)-(8)(9)				<b>TR:</b> Transparent, red <b>TG:</b> Transparent, green <b>TY:</b> Transparent, yellow <b>TW:</b> Transparent, white <b>TA:</b> Transparent, blue <b>TO:</b> Transparent, orange			100 002	<b>R:</b> Red <b>G:</b> Green <b>Y:</b> Yellow <b>W:</b> White <b>A:</b> Blue <b>O:</b> Orange	<b>A:</b> 6 VAC/DC <b>B:</b> 12 VAC/DC <b>C:</b> 24 VAC/DC <b>D:</b> 100/110/120 VAC <b>E:</b> 200/220/230/240 VAC
			A22NL-RPM-(4)(4)A-P(7)(7)(7)-(8)(9)		A22NL-RPA-(4)(4)A-P(7)(7)(7)-(8)(9)									
	2	A22NL-RPM-(4)(4)A-G(7)(7)(7)-(8)(9)	A22NL-RPA-(4)(4)A-G(7)(7)(7)-(8)(9)		101 102 202									
		A22NL-RPM-(4)(4)A-P(7)(7)(7)-(8)(9)	A22NL-RPA-(4)(4)A-P(7)(7)(7)-(8)(9)											

**Note:** Normally, the Button and LED Lamp with the same color are combined. However, opaque white is available by combining a white Button and yellow LED. A22N□-□□□-TWA-□□□□-Y□



■ Subassemblies: Refer to pages 9 to 12 and 82.  
 (You can order Operation Units, LED Lamps, Mounting Collars, and Contact Blocks individually.)

■ Specifications: Refer to page 13.  
 ■ Dimensions: Refer to pages 15 to 17.  
 ■ Accessories and tools: Refer to pages 84 to 85.



# Ordering Information

**Model Numbers for Sets** - - - Shipped as a set that includes the Operation Unit, LED Lamp (lighted models only), Mounting Collar, Contact Block, and Lighting Unit (lighted models only).

## Non-lighted, Full-guard Switches

Appearance	Contacts	Momentary action (self-resetting)	Alternate action (self-holding)	(4)(4) Button color	(7)(7)(7) Contacts
		Model	Model		
 Plastic bezels	1	A22NN-BGM-(4)(4)A-G(7)(7)-NN	A22NN-BGA-(4)(4)A-G(7)(7)-NN	NR: Opaque, red NG: Opaque, green NY: Opaque, yellow NW: Opaque, white NA: Opaque, blue NB: Opaque, black UR: Transparent, red UG: Transparent, green UY: Transparent, yellow UW: Transparent, white UA: Transparent, blue UO: Transparent, orange	100 002
		A22NN-BGM-(4)(4)A-P(7)(7)-NN	A22NN-BGA-(4)(4)A-P(7)(7)-NN		
	2	A22NN-BGM-(4)(4)A-G(7)(7)-NN	A22NN-BGA-(4)(4)A-G(7)(7)-NN		101 102 202
		A22NN-BGM-(4)(4)A-P(7)(7)-NN	A22NN-BGA-(4)(4)A-P(7)(7)-NN		
	3	A22NN-BGM-(4)(4)A-G(7)(7)-NN	A22NN-BGA-(4)(4)A-G(7)(7)-NN		111 112 122 222
		A22NN-BGM-(4)(4)A-P(7)(7)-NN	A22NN-BGA-(4)(4)A-P(7)(7)-NN		
 Brushed metal bezels	1	A22NN-MGM-(4)(4)A-G(7)(7)-NN	A22NN-MGA-(4)(4)A-G(7)(7)-NN	UR: Transparent, red UG: Transparent, green UY: Transparent, yellow UW: Transparent, white UA: Transparent, blue UO: Transparent, orange	100 002
		A22NN-MGM-(4)(4)A-P(7)(7)-NN	A22NN-MGA-(4)(4)A-P(7)(7)-NN		
	2	A22NN-MGM-(4)(4)A-G(7)(7)-NN	A22NN-MGA-(4)(4)A-G(7)(7)-NN		101 102 202
		A22NN-MGM-(4)(4)A-P(7)(7)-NN	A22NN-MGA-(4)(4)A-P(7)(7)-NN		
	3	A22NN-MGM-(4)(4)A-G(7)(7)-NN	A22NN-MGA-(4)(4)A-G(7)(7)-NN		111 112 122 222
		A22NN-MGM-(4)(4)A-P(7)(7)-NN	A22NN-MGA-(4)(4)A-P(7)(7)-NN		

## Lighted, Full-guard Switches

Appearance	Contacts	Momentary action (self-resetting)	Alternate action (self-holding)	(4)(4) Button color	(7)(7)(7) Contacts	(8) LED Lamp color	(9) LED Lamp voltage	
		Model	Model					
 Plastic bezels	1	A22NL-BGM-(4)(4)A-G(7)(7)-(8)(9)	A22NL-BGA-(4)(4)A-G(7)(7)-(8)(9)	TR: Transparent, red TG: Transparent, green TY: Transparent, yellow TW: Transparent, white TA: Transparent, blue TO: Transparent, orange	100 002	R: Red G: Green Y: Yellow W: White A: Blue O: Orange	A: 6 VAC/DC B: 12 VAC/DC C: 24 VAC/DC D: 100/110/120 VAC E: 200/220/230/240 VAC	
		A22NL-BGM-(4)(4)A-P(7)(7)-(8)(9)	A22NL-BGA-(4)(4)A-P(7)(7)-(8)(9)					
	2	A22NL-BGM-(4)(4)A-G(7)(7)-(8)(9)	A22NL-BGA-(4)(4)A-G(7)(7)-(8)(9)		101 102 202			
		A22NL-BGM-(4)(4)A-P(7)(7)-(8)(9)	A22NL-BGA-(4)(4)A-P(7)(7)-(8)(9)					
	 Brushed metal bezels	1	A22NL-MGM-(4)(4)A-G(7)(7)-(8)(9)		A22NL-MGA-(4)(4)A-G(7)(7)-(8)(9)			100 002
			A22NL-MGM-(4)(4)A-P(7)(7)-(8)(9)		A22NL-MGA-(4)(4)A-P(7)(7)-(8)(9)			
2		A22NL-MGM-(4)(4)A-G(7)(7)-(8)(9)	A22NL-MGA-(4)(4)A-G(7)(7)-(8)(9)	101 102 202				
		A22NL-MGM-(4)(4)A-P(7)(7)-(8)(9)	A22NL-MGA-(4)(4)A-P(7)(7)-(8)(9)					

**Note:** Normally, the Button and LED Lamp with the same color are combined.  
 However, opaque white is available by combining a white Button and yellow LED. A22N□-□□□-TWA-□□□□-Y□

■ Subassemblies: Refer to pages 9 to 12 and 82.  
 (You can order Operation Units, LED Lamps, Mounting Collars, and Contact Blocks individually.)

■ Specifications: Refer to page 13.  
 ■ Dimensions: Refer to pages 15 to 17.  
 ■ Accessories and tools: Refer to pages 84 to 85.



Pushbutton Switches  
 A22N  
 Selector Switches  
 A22N  
 Key-type Selector Switches  
 A22N  
 Indicators  
 M22N  
 Pushbutton Switches  
 A30N  
 Selector Switches  
 A30N  
 Key-type Selector Switches  
 A30N  
 Subassemblies (Common)  
 Accessories and Tools  
 Safety Precautions

# A22NN/A22NL



## Ordering Information

**Model Numbers for Sets** - - - Shipped as a set that includes the Operation Unit, LED Lamp (lighted models only), Mounting Collar, Contact Block, and Lighting Unit (lighted models only).

### Non-lighted, Mushroom Switches

Appearance	Contacts	Momentary action (self-resetting)	Alternate action (self-holding)	(4)(4) Button color	(7)(7)(7) Contacts
		Model	Model		
Plastic bezels 	1	A22NN-BMM-(4)(4)A-G(7)(7)(7)-NN	A22NN-BMA-(4)(4)A-G(7)(7)(7)-NN	<b>NR:</b> Opaque, red <b>NG:</b> Opaque, green <b>NY:</b> Opaque, yellow <b>NW:</b> Opaque, white <b>NA:</b> Opaque, blue <b>NB:</b> Opaque, black <b>UR:</b> Transparent, red <b>UG:</b> Transparent, green <b>UY:</b> Transparent, yellow <b>UW:</b> Transparent, white <b>UA:</b> Transparent, blue <b>UO:</b> Transparent, orange	100 002
		A22NN-BMM-(4)(4)A-P(7)(7)(7)-NN	A22NN-BMA-(4)(4)A-P(7)(7)(7)-NN		
	2	A22NN-BMM-(4)(4)A-G(7)(7)(7)-NN	A22NN-BMA-(4)(4)A-G(7)(7)(7)-NN		101 102 202
		A22NN-BMM-(4)(4)A-P(7)(7)(7)-NN	A22NN-BMA-(4)(4)A-P(7)(7)(7)-NN		
	3	A22NN-BMM-(4)(4)A-G(7)(7)(7)-NN	A22NN-BMA-(4)(4)A-G(7)(7)(7)-NN		111 112 122 222
		A22NN-BMM-(4)(4)A-P(7)(7)(7)-NN	A22NN-BMA-(4)(4)A-P(7)(7)(7)-NN		
Brushed metal bezels 	1	A22NN-MMM-(4)(4)A-G(7)(7)(7)-NN	A22NN-MMA-(4)(4)A-G(7)(7)(7)-NN		100 002
		A22NN-MMM-(4)(4)A-P(7)(7)(7)-NN	A22NN-MMA-(4)(4)A-P(7)(7)(7)-NN		
	2	A22NN-MMM-(4)(4)A-G(7)(7)(7)-NN	A22NN-MMA-(4)(4)A-G(7)(7)(7)-NN		101 102 202
		A22NN-MMM-(4)(4)A-P(7)(7)(7)-NN	A22NN-MMA-(4)(4)A-P(7)(7)(7)-NN		
	3	A22NN-MMM-(4)(4)A-G(7)(7)(7)-NN	A22NN-MMA-(4)(4)A-G(7)(7)(7)-NN		111 112 122 222
		A22NN-MMM-(4)(4)A-P(7)(7)(7)-NN	A22NN-MMA-(4)(4)A-P(7)(7)(7)-NN		
Metal bezels 	1	A22NN-RMM-(4)(4)A-G(7)(7)(7)-NN	A22NN-RMA-(4)(4)A-G(7)(7)(7)-NN	100 002	
		A22NN-RMM-(4)(4)A-P(7)(7)(7)-NN	A22NN-RMA-(4)(4)A-P(7)(7)(7)-NN		
	2	A22NN-RMM-(4)(4)A-G(7)(7)(7)-NN	A22NN-RMA-(4)(4)A-G(7)(7)(7)-NN	101 102 202	
		A22NN-RMM-(4)(4)A-P(7)(7)(7)-NN	A22NN-RMA-(4)(4)A-P(7)(7)(7)-NN		
	3	A22NN-RMM-(4)(4)A-G(7)(7)(7)-NN	A22NN-RMA-(4)(4)A-G(7)(7)(7)-NN	111 112 122 222	
		A22NN-RMM-(4)(4)A-P(7)(7)(7)-NN	A22NN-RMA-(4)(4)A-P(7)(7)(7)-NN		

### Lighted, Mushroom Switches

Appearance	Contacts	Momentary action (self-resetting)	Alternate action (self-holding)	(4)(4) Button color	(7)(7)(7) Contacts	(8) LED Lamp color	(9) LED Lamp voltage	
		Model	Model					
Plastic bezels 	1	A22NL-BMM-(4)(4)A-G(7)(7)(7)-(8)(9)	A22NL-BMA-(4)(4)A-G(7)(7)(7)-(8)(9)	<b>TR:</b> Transparent, red <b>TG:</b> Transparent, green <b>TY:</b> Transparent, yellow <b>TW:</b> Transparent, white <b>TA:</b> Transparent, blue <b>TO:</b> Transparent, orange	100 002	<b>R:</b> Red <b>G:</b> Green <b>Y:</b> Yellow <b>W:</b> White <b>A:</b> Blue <b>O:</b> Orange	<b>A:</b> 6 VAC/DC <b>B:</b> 12 VAC/DC <b>C:</b> 24 VAC/DC <b>D:</b> 100/110/120 VAC <b>E:</b> 200/220/230/240 VAC	
		A22NL-BMM-(4)(4)A-P(7)(7)(7)-(8)(9)	A22NL-BMA-(4)(4)A-P(7)(7)(7)-(8)(9)					
	2	A22NL-BMM-(4)(4)A-G(7)(7)(7)-(8)(9)	A22NL-BMA-(4)(4)A-G(7)(7)(7)-(8)(9)		101 102 202			
		A22NL-BMM-(4)(4)A-P(7)(7)(7)-(8)(9)	A22NL-BMA-(4)(4)A-P(7)(7)(7)-(8)(9)					
	Brushed metal bezels 	1	A22NL-MMM-(4)(4)A-G(7)(7)(7)-(8)(9)		A22NL-MMA-(4)(4)A-G(7)(7)(7)-(8)(9)			100 002
			A22NL-MMM-(4)(4)A-P(7)(7)(7)-(8)(9)		A22NL-MMA-(4)(4)A-P(7)(7)(7)-(8)(9)			
2		A22NL-MMM-(4)(4)A-G(7)(7)(7)-(8)(9)	A22NL-MMA-(4)(4)A-G(7)(7)(7)-(8)(9)		101 102 202			
		A22NL-MMM-(4)(4)A-P(7)(7)(7)-(8)(9)	A22NL-MMA-(4)(4)A-P(7)(7)(7)-(8)(9)					
Metal bezels 		1	A22NL-RMM-(4)(4)A-G(7)(7)(7)-(8)(9)		A22NL-RMA-(4)(4)A-G(7)(7)(7)-(8)(9)			100 002
			A22NL-RMM-(4)(4)A-P(7)(7)(7)-(8)(9)		A22NL-RMA-(4)(4)A-P(7)(7)(7)-(8)(9)			
	2	A22NL-RMM-(4)(4)A-G(7)(7)(7)-(8)(9)	A22NL-RMA-(4)(4)A-G(7)(7)(7)-(8)(9)		101 102 202			
		A22NL-RMM-(4)(4)A-P(7)(7)(7)-(8)(9)	A22NL-RMA-(4)(4)A-P(7)(7)(7)-(8)(9)					

**Note:** Normally, the Button and LED Lamp with the same color are combined. However, opaque white is available by combining a white Button and yellow LED. A22NN□-□□□-TWA-□□□□-Y□

■ Subassemblies: Refer to pages 9 to 12 and 82.  
 (You can order Operation Units, LED Lamps, Mounting Collars, and Contact Blocks individually.)

■ Specifications: Refer to page 13.  
 ■ Dimensions: Refer to pages 15 to 17.  
 ■ Accessories and tools: Refer to pages 84 to 85.



# Ordering Information

**Switch Structure** - - - You can order Operation Units, LED Lamps (lighted models only), Mounting Collars, Contact Blocks, and Lighting Units (lighted models only) separately. Use them in combination for models that are not available as assembled Switches. They can also be used as inventory for maintenance parts.

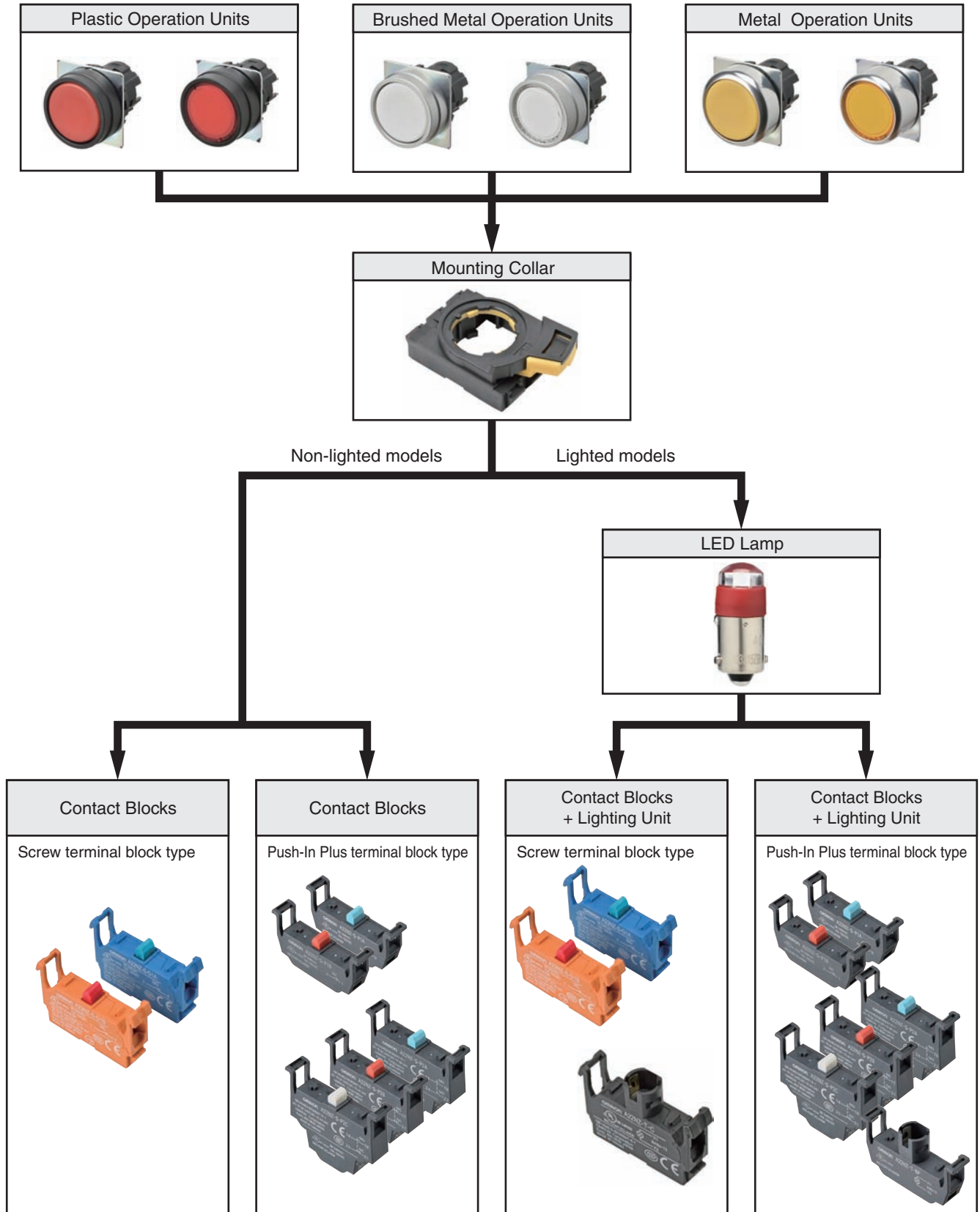

- Model numbers of sets: Refer to pages 5 to 8.
- Subassemblies (Common): Refer to page 82.

- Specifications: Refer to page 13.
- Dimensions: Refer to pages 15 to 17.
- Accessories and tools: Refer to pages 84 to 85.

Pushbutton Switches  
**A22N**  
 Selector Switches  
**A22N**  
 Key-type Selector Switches  
**A22N**  
 Indicators  
**M22N**  
 Pushbutton Switches  
**A30N**  
 Selector Switches  
**A30N**  
 Key-type Selector Switches  
**A30N**  
 Subassemblies (Common)  
 Accessories and Tools  
 Safety Precautions

# Ordering Information

## Subassemblies

----- You can order Operation Units, LED Lamps (lighted models only), Mounting Collars, Contact Blocks, and Lighting Units (lighted models only) separately. Use them in combination for models that are not available as assembled Switches. They can also be used as inventory for maintenance parts.

## Operation Units

Bezel material and button shape			Plastic, flat		Plastic, projected	
			Switch Action		Momentary	Alternate
Lighted/ non-lighted	Transparency	Color	Model		Model	
			Non-lighted	Opaque	Red	A22NZ-BNM-NRA
Opaque	Green	A22NZ-BNM-NGA		A22NZ-BNA-NGA	A22NZ-BPM-NGA	A22NZ-BPA-NGA
Opaque	Yellow	A22NZ-BNM-NYA		A22NZ-BNA-NYA	A22NZ-BPM-NYA	A22NZ-BPA-NYA
Opaque	White	A22NZ-BNM-NWA		A22NZ-BNA-NWA	A22NZ-BPM-NWA	A22NZ-BPA-NWA
Opaque	Blue	A22NZ-BNM-NAA		A22NZ-BNA-NAA	A22NZ-BPM-NAA	A22NZ-BPA-NAA
Opaque	Black	A22NZ-BNM-NBA		A22NZ-BNA-NBA	A22NZ-BPM-NBA	A22NZ-BPA-NBA
Transparent	Red	A22NZ-BNM-URA		A22NZ-BNA-URA	A22NZ-BPM-URA	A22NZ-BPA-URA
Transparent	Green	A22NZ-BNM-UGA		A22NZ-BNA-UGA	A22NZ-BPM-UGA	A22NZ-BPA-UGA
Transparent	Yellow	A22NZ-BNM-UYA		A22NZ-BNA-UYA	A22NZ-BPM-UYA	A22NZ-BPA-UYA
Transparent	White	A22NZ-BNM-UWA		A22NZ-BNA-UWA	A22NZ-BPM-UWA	A22NZ-BPA-UWA
Transparent	Blue	A22NZ-BNM-UAA		A22NZ-BNA-UAA	A22NZ-BPM-UAA	A22NZ-BPA-UAA
Transparent	Orange	A22NZ-BNM-UOA		A22NZ-BNA-UOA	A22NZ-BPM-UOA	A22NZ-BPA-UOA
Lighted	Transparent	Red	A22NZ-BNM-TRA	A22NZ-BNA-TRA	A22NZ-BPM-TRA	A22NZ-BPA-TRA
	Transparent	Green	A22NZ-BNM-TGA	A22NZ-BNA-TGA	A22NZ-BPM-TGA	A22NZ-BPA-TGA
	Transparent	Yellow	A22NZ-BNM-TYA	A22NZ-BNA-TYA	A22NZ-BPM-TYA	A22NZ-BPA-TYA
	Transparent	White	A22NZ-BNM-TWA	A22NZ-BNA-TWA	A22NZ-BPM-TWA	A22NZ-BPA-TWA
	Transparent	Blue	A22NZ-BNM-TAA	A22NZ-BNA-TAA	A22NZ-BPM-TAA	A22NZ-BPA-TAA
	Transparent	Orange	A22NZ-BNM-TOA	A22NZ-BNA-TOA	A22NZ-BPM-TOA	A22NZ-BPA-TOA

Bezel material and button shape			Plastic, full-guard		Plastic, mushroom	
			Switch Action		Momentary	Alternate
Lighted/ non-lighted	Transparency	Color	Model		Model	
			Non-lighted	Opaque	Red	A22NZ-BGM-NRA
Opaque	Green	A22NZ-BGM-NGA		A22NZ-BGA-NGA	A22NZ-BMM-NGA	A22NZ-BMA-NGA
Opaque	Yellow	A22NZ-BGM-NYA		A22NZ-BGA-NYA	A22NZ-BMM-NYA	A22NZ-BMA-NYA
Opaque	White	A22NZ-BGM-NWA		A22NZ-BGA-NWA	A22NZ-BMM-NWA	A22NZ-BMA-NWA
Opaque	Blue	A22NZ-BGM-NAA		A22NZ-BGA-NAA	A22NZ-BMM-NAA	A22NZ-BMA-NAA
Opaque	Black	A22NZ-BGM-NBA		A22NZ-BGA-NBA	A22NZ-BMM-NBA	A22NZ-BMA-NBA
Transparent	Red	A22NZ-BGM-URA		A22NZ-BGA-URA	A22NZ-BMM-URA	A22NZ-BMA-URA
Transparent	Green	A22NZ-BGM-UGA		A22NZ-BGA-UGA	A22NZ-BMM-UGA	A22NZ-BMA-UGA
Transparent	Yellow	A22NZ-BGM-UYA		A22NZ-BGA-UYA	A22NZ-BMM-UYA	A22NZ-BMA-UYA
Transparent	White	A22NZ-BGM-UWA		A22NZ-BGA-UWA	A22NZ-BMM-UWA	A22NZ-BMA-UWA
Transparent	Blue	A22NZ-BGM-UAA		A22NZ-BGA-UAA	A22NZ-BMM-UAA	A22NZ-BMA-UAA
Transparent	Orange	A22NZ-BGM-UOA		A22NZ-BGA-UOA	A22NZ-BMM-UOA	A22NZ-BMA-UOA
Lighted	Transparent	Red	A22NZ-BGM-TRA	A22NZ-BGA-TRA	A22NZ-BMM-TRA	A22NZ-BMA-TRA
	Transparent	Green	A22NZ-BGM-TGA	A22NZ-BGA-TGA	A22NZ-BMM-TGA	A22NZ-BMA-TGA
	Transparent	Yellow	A22NZ-BGM-TYA	A22NZ-BGA-TYA	A22NZ-BMM-TYA	A22NZ-BMA-TYA
	Transparent	White	A22NZ-BGM-TWA	A22NZ-BGA-TWA	A22NZ-BMM-TWA	A22NZ-BMA-TWA
	Transparent	Blue	A22NZ-BGM-TAA	A22NZ-BGA-TAA	A22NZ-BMM-TAA	A22NZ-BMA-TAA
	Transparent	Orange	A22NZ-BGM-TOA	A22NZ-BGA-TOA	A22NZ-BMM-TOA	A22NZ-BMA-TOA

- Model numbers of sets: Refer to pages 5 to 8.
- Subassemblies (Common): Refer to page 82.

- Specifications: Refer to page 13.
- Dimensions: Refer to pages 15 to 17.
- Accessories and tools: Refer to pages 84 to 85.

Pushbutton Switches A22N  
 Selector Switches A22N  
 Key-Type Selector Switches A22N  
 Indicators M22N  
 Pushbutton Switches A30N  
 Selector Switches A30N  
 Key-Type Selector Switches A30N  
 Subassemblies (Common)  
 Accessories and Tools  
 Safety Precautions

# Ordering Information

## Subassemblies

-----You can order Operation Units, LED Lamps (lighted models only), Mounting Collars, Contact Blocks, and Lighting Units (lighted models only) separately. Use them in combination for models that are not available as assembled Switches. They can also be used as inventory for maintenance parts.

Bezel material and button shape			Brushed metal, flat		Brushed metal, projected	
			Switch Action		Switch Action	
Lighted/ non-lighted	Transparency	Color	Momentary	Alternate	Momentary	Alternate
			Model	Model	Model	Model
Non-lighted	Opaque	Red	A22NZ-MNM-NRA	A22NZ-MNA-NRA	A22NZ-MPM-NRA	A22NZ-MPA-NRA
	Opaque	Green	A22NZ-MNM-NGA	A22NZ-MNA-NGA	A22NZ-MPM-NGA	A22NZ-MPA-NGA
	Opaque	Yellow	A22NZ-MNM-NYA	A22NZ-MNA-NYA	A22NZ-MPM-NYA	A22NZ-MPA-NYA
	Opaque	White	A22NZ-MNM-NWA	A22NZ-MNA-NWA	A22NZ-MPM-NWA	A22NZ-MPA-NWA
	Opaque	Blue	A22NZ-MNM-NAA	A22NZ-MNA-NAA	A22NZ-MPM-NAA	A22NZ-MPA-NAA
	Opaque	Black	A22NZ-MNM-NBA	A22NZ-MNA-NBA	A22NZ-MPM-NBA	A22NZ-MPA-NBA
	Transparent	Red	A22NZ-MNM-URA	A22NZ-MNA-URA	A22NZ-MPM-URA	A22NZ-MPA-URA
	Transparent	Green	A22NZ-MNM-UGA	A22NZ-MNA-UGA	A22NZ-MPM-UGA	A22NZ-MPA-UGA
	Transparent	Yellow	A22NZ-MNM-UYA	A22NZ-MNA-UYA	A22NZ-MPM-UYA	A22NZ-MPA-UYA
	Transparent	White	A22NZ-MNM-UWA	A22NZ-MNA-UWA	A22NZ-MPM-UWA	A22NZ-MPA-UWA
	Transparent	Blue	A22NZ-MNM-UAA	A22NZ-MNA-UAA	A22NZ-MPM-UAA	A22NZ-MPA-UAA
	Transparent	Orange	A22NZ-MNM-UOA	A22NZ-MNA-UOA	A22NZ-MPM-UOA	A22NZ-MPA-UOA
Lighted	Transparent	Red	A22NZ-MNM-TRA	A22NZ-MNA-TRA	A22NZ-MPM-TRA	A22NZ-MPA-TRA
	Transparent	Green	A22NZ-MNM-TGA	A22NZ-MNA-TGA	A22NZ-MPM-TGA	A22NZ-MPA-TGA
	Transparent	Yellow	A22NZ-MNM-TYA	A22NZ-MNA-TYA	A22NZ-MPM-TYA	A22NZ-MPA-TYA
	Transparent	White	A22NZ-MNM-TWA	A22NZ-MNA-TWA	A22NZ-MPM-TWA	A22NZ-MPA-TWA
	Transparent	Blue	A22NZ-MNM-TAA	A22NZ-MNA-TAA	A22NZ-MPM-TAA	A22NZ-MPA-TAA
	Transparent	Orange	A22NZ-MNM-TOA	A22NZ-MNA-TOA	A22NZ-MPM-TOA	A22NZ-MPA-TOA

Bezel material and button shape			Brushed metal, full-guard		Brushed metal, mushroom	
			Switch Action		Switch Action	
Lighted/ non-lighted	Transparency	Color	Momentary	Alternate	Momentary	Alternate
			Model	Model	Model	Model
Non-lighted	Opaque	Red	A22NZ-MGM-NRA	A22NZ-MGA-NRA	A22NZ-MMM-NRA	A22NZ-MMA-NRA
	Opaque	Green	A22NZ-MGM-NGA	A22NZ-MGA-NGA	A22NZ-MMM-NGA	A22NZ-MMA-NGA
	Opaque	Yellow	A22NZ-MGM-NYA	A22NZ-MGA-NYA	A22NZ-MMM-NYA	A22NZ-MMA-NYA
	Opaque	White	A22NZ-MGM-NWA	A22NZ-MGA-NWA	A22NZ-MMM-NWA	A22NZ-MMA-NWA
	Opaque	Blue	A22NZ-MGM-NAA	A22NZ-MGA-NAA	A22NZ-MMM-NAA	A22NZ-MMA-NAA
	Opaque	Black	A22NZ-MGM-NBA	A22NZ-MGA-NBA	A22NZ-MMM-NBA	A22NZ-MMA-NBA
	Transparent	Red	A22NZ-MGM-URA	A22NZ-MGA-URA	A22NZ-MMM-URA	A22NZ-MMA-URA
	Transparent	Green	A22NZ-MGM-UGA	A22NZ-MGA-UGA	A22NZ-MMM-UGA	A22NZ-MMA-UGA
	Transparent	Yellow	A22NZ-MGM-UYA	A22NZ-MGA-UYA	A22NZ-MMM-UYA	A22NZ-MMA-UYA
	Transparent	White	A22NZ-MGM-UWA	A22NZ-MGA-UWA	A22NZ-MMM-UWA	A22NZ-MMA-UWA
	Transparent	Blue	A22NZ-MGM-UAA	A22NZ-MGA-UAA	A22NZ-MMM-UAA	A22NZ-MMA-UAA
	Transparent	Orange	A22NZ-MGM-UOA	A22NZ-MGA-UOA	A22NZ-MMM-UOA	A22NZ-MMA-UOA
Lighted	Transparent	Red	A22NZ-MGM-TRA	A22NZ-MGA-TRA	A22NZ-MMM-TRA	A22NZ-MMA-TRA
	Transparent	Green	A22NZ-MGM-TGA	A22NZ-MGA-TGA	A22NZ-MMM-TGA	A22NZ-MMA-TGA
	Transparent	Yellow	A22NZ-MGM-TYA	A22NZ-MGA-TYA	A22NZ-MMM-TYA	A22NZ-MMA-TYA
	Transparent	White	A22NZ-MGM-TWA	A22NZ-MGA-TWA	A22NZ-MMM-TWA	A22NZ-MMA-TWA
	Transparent	Blue	A22NZ-MGM-TAA	A22NZ-MGA-TAA	A22NZ-MMM-TAA	A22NZ-MMA-TAA
	Transparent	Orange	A22NZ-MGM-TOA	A22NZ-MGA-TOA	A22NZ-MMM-TOA	A22NZ-MMA-TOA

- Model numbers of sets: Refer to pages 5 to 8.
- Subassemblies (Common): Refer to page 82.

- Specifications: Refer to page 13.
- Dimensions: Refer to pages 15 to 17.
- Accessories and tools: Refer to pages 84 to 85.

Pushbutton Switches  
**A22N**  
 Selector Switches  
**A22N**  
 Key-type Selector Switches  
**A22N**  
 Indicators  
**M22N**  
 Pushbutton Switches  
**A30N**  
 Selector Switches  
**A30N**  
 Key-type Selector Switches  
**A30N**  
 Subassemblies (Common)  
 Accessories and Tools  
 Safety Precautions

Ordering Information

**Subassemblies** - - - - You can order Operation Units, LED Lamps (lighted models only), Mounting Collars, Contact Blocks, and Lighting Units (lighted models only) separately. Use them in combination for models that are not available as assembled Switches. They can also be used as inventory for maintenance parts.

Bezel material and button shape			Metal, flat		Metal, projected	
			Switch Action		Momentary	Alternate
Lighted/ non-lighted	Transparency	Color	Model	Model	Model	Model
			Non-lighted	Opaque	Red	A22NZ-RNM-NRA
Opaque	Green	A22NZ-RNM-NGA		A22NZ-RNA-NGA	A22NZ-RPM-NGA	A22NZ-RPA-NGA
Opaque	Yellow	A22NZ-RNM-NYA		A22NZ-RNA-NYA	A22NZ-RPM-NYA	A22NZ-RPA-NYA
Opaque	White	A22NZ-RNM-NWA		A22NZ-RNA-NWA	A22NZ-RPM-NWA	A22NZ-RPA-NWA
Opaque	Blue	A22NZ-RNM-NAA		A22NZ-RNA-NAA	A22NZ-RPM-NAA	A22NZ-RPA-NAA
Opaque	Black	A22NZ-RNM-NBA		A22NZ-RNA-NBA	A22NZ-RPM-NBA	A22NZ-RPA-NBA
Transparent	Red	A22NZ-RNM-URA		A22NZ-RNA-URA	A22NZ-RPM-URA	A22NZ-RPA-URA
Transparent	Green	A22NZ-RNM-UGA		A22NZ-RNA-UGA	A22NZ-RPM-UGA	A22NZ-RPA-UGA
Transparent	Yellow	A22NZ-RNM-UYA		A22NZ-RNA-UYA	A22NZ-RPM-UYA	A22NZ-RPA-UYA
Transparent	White	A22NZ-RNM-UWA		A22NZ-RNA-UWA	A22NZ-RPM-UWA	A22NZ-RPA-UWA
Transparent	Blue	A22NZ-RNM-UAA		A22NZ-RNA-UAA	A22NZ-RPM-UAA	A22NZ-RPA-UAA
Transparent	Orange	A22NZ-RNM-UOA		A22NZ-RNA-UOA	A22NZ-RPM-UOA	A22NZ-RPA-UOA
Lighted	Transparent	Red	A22NZ-RNM-TRA	A22NZ-RNA-TRA	A22NZ-RPM-TRA	A22NZ-RPA-TRA
	Transparent	Green	A22NZ-RNM-TGA	A22NZ-RNA-TGA	A22NZ-RPM-TGA	A22NZ-RPA-TGA
	Transparent	Yellow	A22NZ-RNM-TYA	A22NZ-RNA-TYA	A22NZ-RPM-TYA	A22NZ-RPA-TYA
	Transparent	White	A22NZ-RNM-TWA	A22NZ-RNA-TWA	A22NZ-RPM-TWA	A22NZ-RPA-TWA
	Transparent	Blue	A22NZ-RNM-TAA	A22NZ-RNA-TAA	A22NZ-RPM-TAA	A22NZ-RPA-TAA
	Transparent	Orange	A22NZ-RNM-TOA	A22NZ-RNA-TOA	A22NZ-RPM-TOA	A22NZ-RPA-TOA

Bezel material and button shape			Metal, mushroom	
			Switch Action	
Lighted/ non-lighted	Transparency	Color	Model	Model
			Non-lighted	Opaque
Opaque	Green	A22NZ-RMM-NGA		A22NZ-RMA-NGA
Opaque	Yellow	A22NZ-RMM-NYA		A22NZ-RMA-NYA
Opaque	White	A22NZ-RMM-NWA		A22NZ-RMA-NWA
Opaque	Blue	A22NZ-RMM-NAA		A22NZ-RMA-NAA
Opaque	Black	A22NZ-RMM-NBA		A22NZ-RMA-NBA
Transparent	Red	A22NZ-RMM-URA		A22NZ-RMA-URA
Transparent	Green	A22NZ-RMM-UGA		A22NZ-RMA-UGA
Transparent	Yellow	A22NZ-RMM-UYA		A22NZ-RMA-UYA
Transparent	White	A22NZ-RMM-UWA		A22NZ-RMA-UWA
Transparent	Blue	A22NZ-RMM-UAA		A22NZ-RMA-UAA
Transparent	Orange	A22NZ-RMM-UOA		A22NZ-RMA-UOA
Lighted	Transparent	Red	A22NZ-RMM-TRA	A22NZ-RMA-TRA
	Transparent	Green	A22NZ-RMM-TGA	A22NZ-RMA-TGA
	Transparent	Yellow	A22NZ-RMM-TYA	A22NZ-RMA-TYA
	Transparent	White	A22NZ-RMM-TWA	A22NZ-RMA-TWA
	Transparent	Blue	A22NZ-RMM-TAA	A22NZ-RMA-TAA
	Transparent	Orange	A22NZ-RMM-TOA	A22NZ-RMA-TOA

■ Model numbers of sets: Refer to pages 5 to 8.  
 ■ Subassemblies (Common): Refer to page 82.

■ Specifications: Refer to page 13.  
 ■ Dimensions: Refer to pages 15 to 17.  
 ■ Accessories and tools: Refer to pages 84 to 85.

## Specifications

### Certified Safety Standard Ratings

UL 508 (File No. E76675), CSA C22.2 No.14

6 A 240 VAC, 10 A 120 VAC

TÜV (EN60947-5-1)

AC-15 3 A 240 VAC

DC-13 4 A 24 VDC

CCC (GB14048.5)

AC-15 3 A 240 VAC

DC-13 4 A 24 VDC

### Application Standards

UL1059 and UL486E (Push-In Plus terminal block type)

### Ratings

#### Contacts (Standard Load)

Rated insulation voltage		600 V				
Rated carry current		10 A				
Rated voltage		24 V	120 V	240 V	380 V	440 V
AC at 50/60 Hz	Resistive load (AC-12)	10 A	10 A	6 A	2A	2 A
	Inductive load (AC-15)	10 A	6 A	3 A	1.9 A	1.6 A
DC	Resistive load (DC-12)	8 A	2.2 A	1.1 A	---	---
	Inductive load (DC-13)	4 A	1.1 A	0.55 A	---	---

**Note:** 1. The above ratings were obtained by conducting tests under the following conditions.

(1) Ambient temperature: 20 ±2°C

(2) Ambient humidity: 65% ±5% RH

(3) Operating frequency: 30 operations/minute

2. Minimum applicable load: 10 mA at 5 VDC.

### LED Lamps

Rated voltage	Applied voltage	Rated current
6 VAC/DC	6 VAC/DC ±10%	Approx. 11 mA (red, orange, yellow, or blue) Approx. 5 mA (white or green)
12 VAC/DC	12 VAC/DC ±10%	Approx. 12 mA (red, orange, yellow, or blue) Approx. 5 mA (white or green)
24 VAC/DC	24 VAC/DC ±10%	Approx. 12 mA (red, orange, yellow, or blue) Approx. 5 mA (white or green)
100 VAC	100 VAC ±10%	Approx. 12 mA (red, orange, yellow, or blue) Approx. 5 mA (white or green)
110 VAC	110 VAC ±10%	
120 VAC	100 to 130 VAC	Approx. 12 mA (red, orange, yellow, or blue) Approx. 5 mA (white or green)
200 VAC	200 VAC ±10%	
220 VAC	220 VAC ±10%	
230 VAC	230 VAC ±10%	
240 VAC	220 to 250 VAC	

# A22NN/A22NL

## Specifications

### Characteristics

Item	Type	Pushbutton Switches	
		Non-lighted models	Lighted models
Allowable operating frequency	Mechanical	60 operations/minute max.	
	Electrical	30 operations/minute max.	
Insulation resistance		100 MΩ min. (at 500 VDC)	Not available for lighting units
Contact resistance		100 mΩ max. (initial value)	
Dielectric strength	Between terminals of same polarity	2,500 VAC at 50/60 Hz for 1 min. (initial value)	Not available for lighting units
	Between each terminal and ground	2,500 VAC at 50/60 Hz for 1 min. (initial value)	
Vibration resistance	Malfunction	10 to 55 Hz, 1.5-mm double amplitude (malfunction within 1 ms)	
Shock resistance	Malfunction	1,000 m/s <sup>2</sup> max. (malfunction within 1 ms)	
Durability	Mechanical	Momentary action: 5,000,000 operations min. Alternate action: 500,000 operations min.	
	Electrical	500,000 operations min. (250 VAC, 3 A, with an inductive load having power factor cos θ = 0.4)	
Ambient operating temperature <sup>*1</sup>		-25 to 70°C	-25 to 55°C
Ambient operating humidity		35% to 85% RH	
Ambient storage temperature <sup>*1</sup>		-40 to 80°C	
Degree of protection <sup>*2</sup>		Conforming to IP66, NEMA 4X, NEMA13	
Electric shock protection class		Class II	
PTI (tracking characteristic)		175	
Degree of contamination (application environment)		3 (EN 60947-5-1)	
Weight		Approx. 50 g (for 1NC/1NO)	Approx. 65 g (for 1NC/1NO)

\*1. With no icing or condensation.

\*2. Degree of protection from the front of the panel.

### Operating Characteristics (for SPST-NO/SPST-NC)

Item	Type	Pushbutton Switches
		Lighted/non-lighted
Total travel force (torque) (maximum TTF)		18 N
Total travel (TT)		6 mm max.
Resetting force (torque) (RF)		---

### Examples of Linked Contact Blocks (Screw terminal block type)

 Contact Blocks  Lighting Units

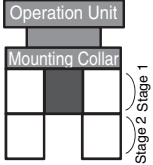
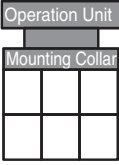
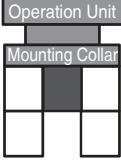
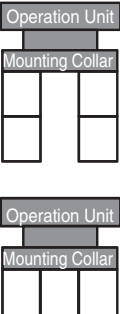
	Pushbutton Switches			
	Momentary		Alternate	
	Lighted	Non-lighted	Lighted	Non-lighted
Linking example				

**Note:** If you increase the number of Contact Blocks, evaluate the Switch under actual working conditions before permanent installation and use the Switch within a number of switching operations that will not adversely affect the Switch's performance.

# Dimensions

(Unit: mm)

## Lighted and Non-lighted Pushbutton Switches

### Flat Switches with Plastic Bezels

A22NN-BN□-N□A-G□-NN

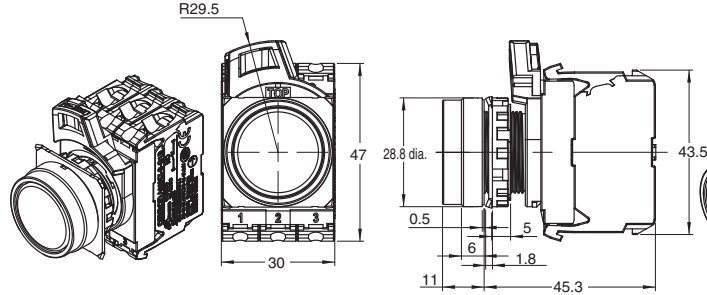

A22NN-BN□-N□A-P□-NN

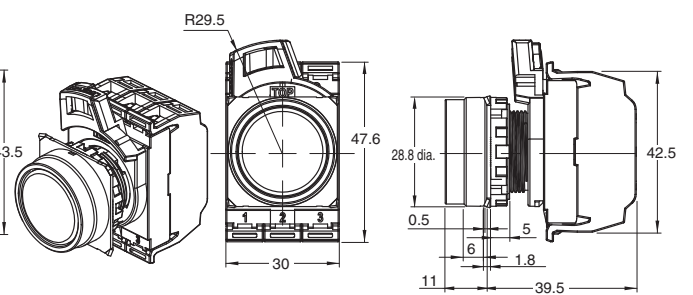

A22NL-BN□-T□A-G□-□□  
A22NN-BN□-U□A-G□-NN

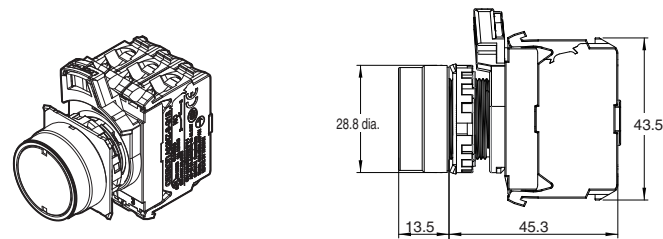

A22NL-BN□-T□A-P□-□□  
A22NN-BN□-U□A-P□-NN

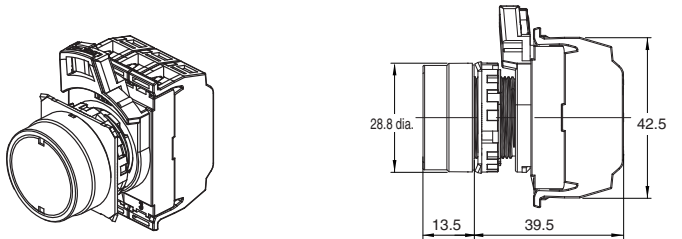

### Projected Switches with Plastic Bezels

A22N□-BP□-□A-G□-□□

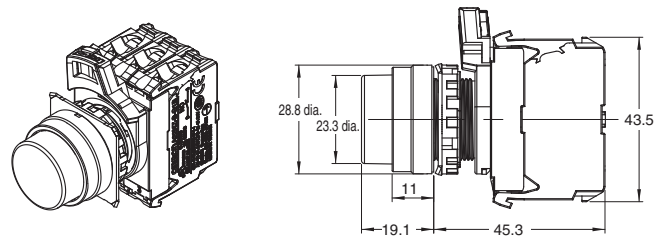

A22N□-BP□-□A-P□-□□

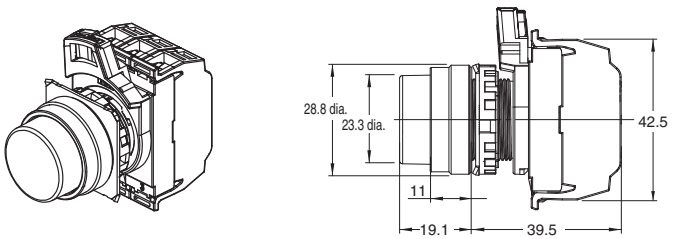

### Full-guard Switches with Plastic Bezels

A22N□-BG□-□A-G□-□□

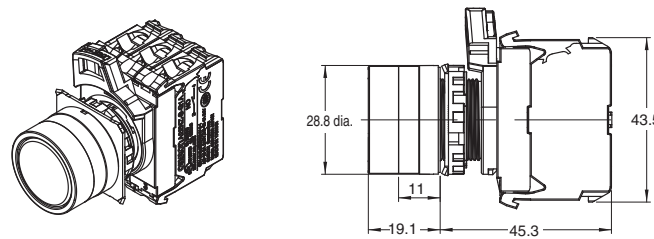

A22N□-BG□-□A-P□-□□

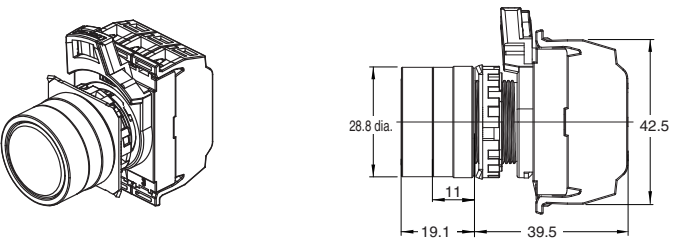

### Mushroom Switches with Plastic Bezels

A22N□-BM□-□A-G□-□□

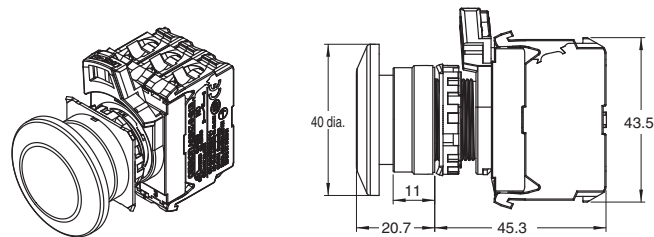

A22N□-BM□-□A-P□-□□

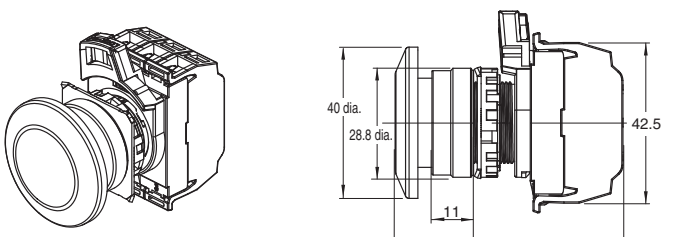

Selector Switches  
A22N

Key-type Selector Switches  
A22N

Indicators  
M22N

Pushbutton Switches  
A30N

Selector Switches  
A30N

Key-type Selector Switches  
A30N

Subassemblies  
(Common)

Accessories  
and Tools

Safety  
Precautions

# A22NN/A22NL

## Dimensions

(Unit: mm)

### Flat Switches with Brushed Metal Bezels

A22NN-MN□-N□A-G□-NN

A22NN-MN□-N□A-P□-NN

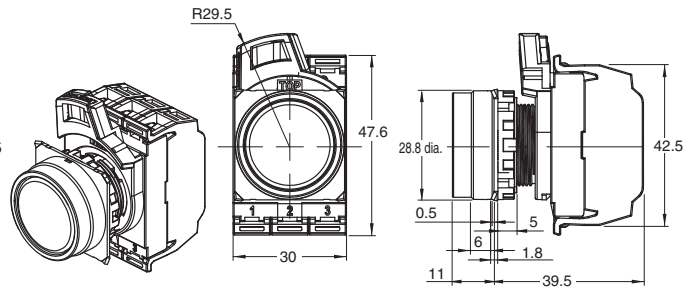
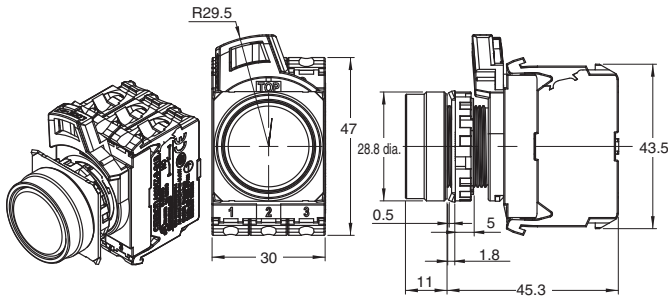

A22NL-MN□-T□A-G□-□□

A22NL-MN□-T□A-P□-□□

A22NN-MN□-U□A-G□-NN

A22NN-MN□-U□A-P□-NN

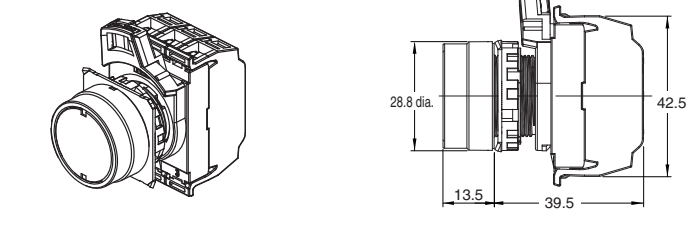
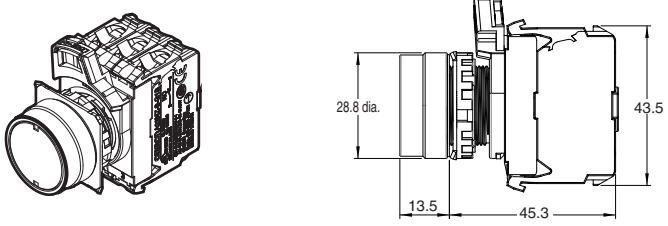

### Projected Switches with Brushed Metal Bezels

A22N□-MP□-□A-G□-□□

A22N□-MP□-□A-P□-□□

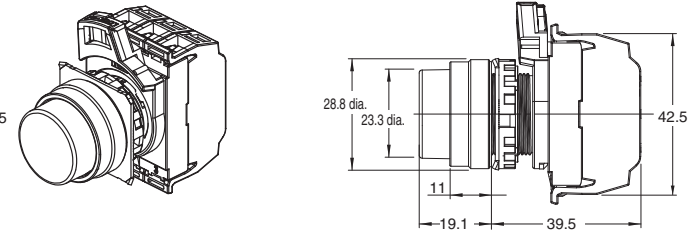
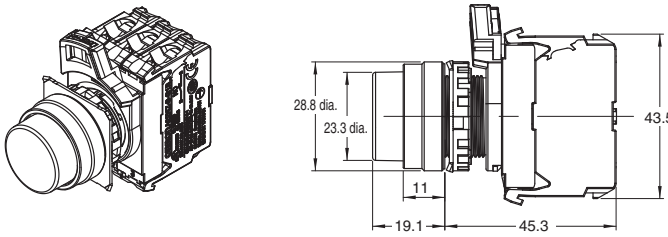

### Full-guard Switches with Brushed Metal Bezels

A22N□-MG□-□A-G□-□□

A22N□-MG□-□A-P□-□□

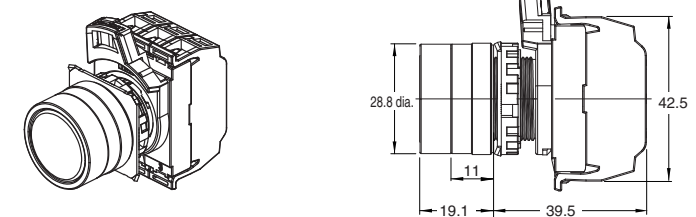
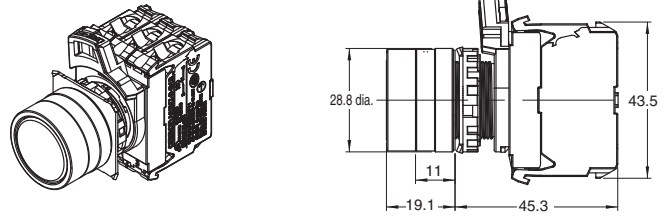

### Mushroom Switches with Brushed Metal Bezels

A22N□-MM□-□A-G□-□□

A22N□-MM□-□A-P□-□□

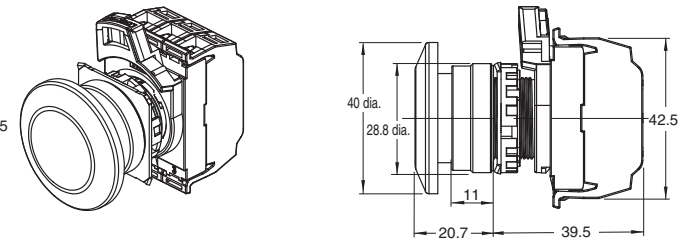
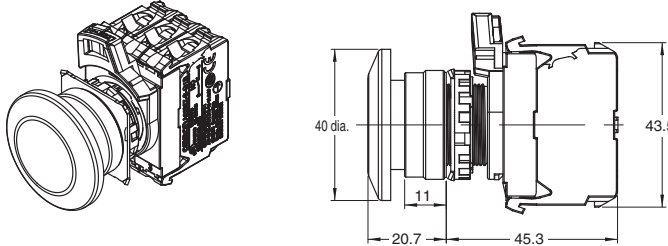

Pushbutton Switches  
A22N

Selector Switches  
A22N

Key-Type Selector Switches  
A22N

Indicators  
M22N

Pushbutton Switches  
A30N

Selector Switches  
A30N

Key-Type Selector Switches  
A30N

Subassemblies  
(Common)

Accessories  
and Tools

Safety  
Precautions



Dimensions

(Unit: mm)

Flat Switches with Metal Bezels

A22NN-RN□-N□A-G□-NN

A22NN-RN□-N□A-P□-NN

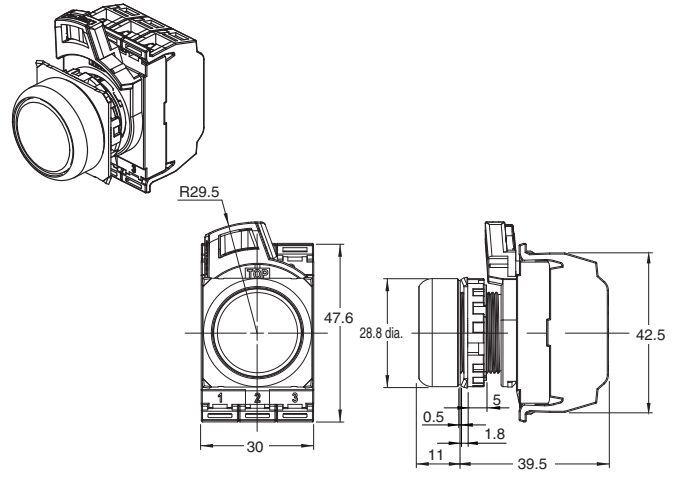
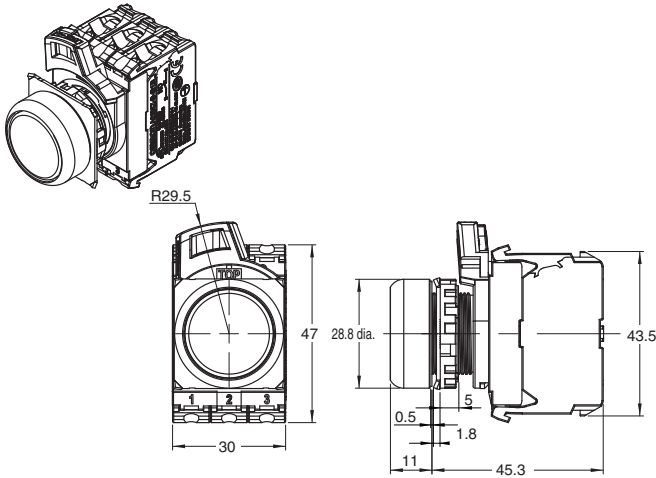

A22NL-RN□-T□A-G□-□□  
A22NN-RN□-U□A-G□-NN

A22NL-RN□-T□A-P□-□□  
A22NN-RN□-U□A-P□-NN

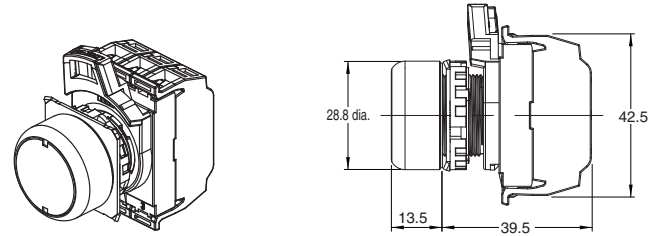
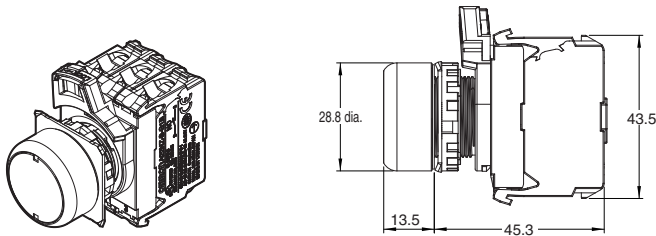

Projected Switches with Metal Bezels

A22N□-RP□-□A-G□-□□

A22N□-RP□-□A-P□-□□

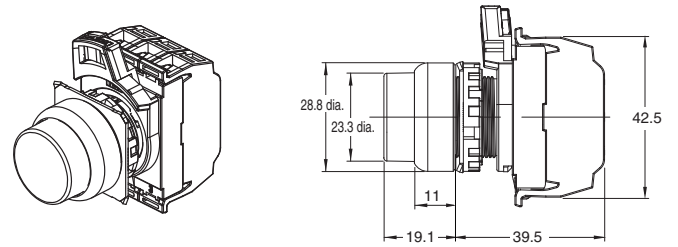
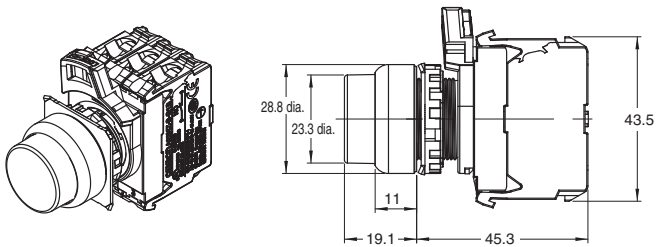

Mushroom Switches with Metal Bezels

A22N□-RM□-□A-G□-□□

A22N□-RM□-□A-P□-□□

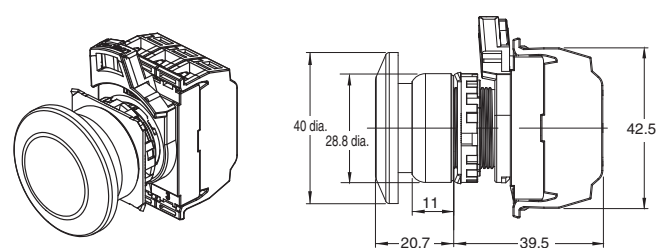
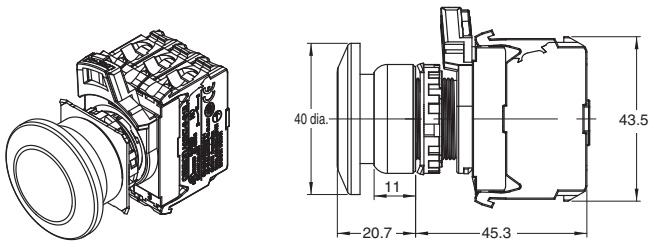

Pushbutton Switches  
A22N

Selector Switches  
A22N

Key-type Selector Switches  
A22N

Indicators  
M22N

Pushbutton Switches  
A30N

Selector Switches  
A30N

Key-type Selector Switches  
A30N

Subassemblies  
(Common)

Accessories  
and Tools

Safety  
Precautions

# A22NN/A22NL

## Depth with Linked Units (Screw terminal block type)

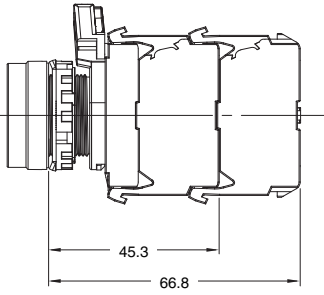

## Depth when a double-contact unit is mounted (Push-In Plus terminal block type)

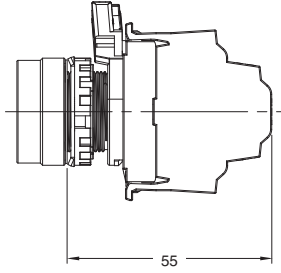

## Terminal Arrangement

### BOTTOM VIEW (Screw terminal block type)

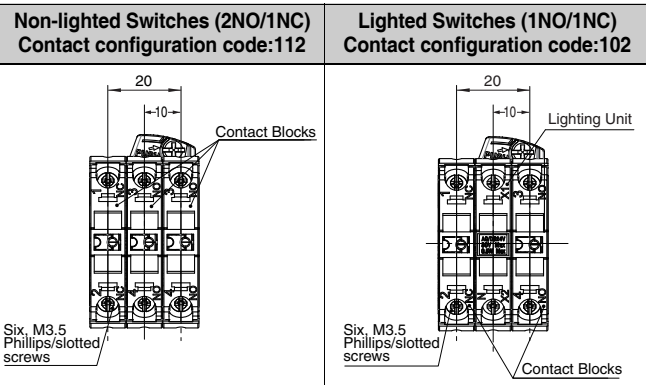

## Terminal Connection Diagrams

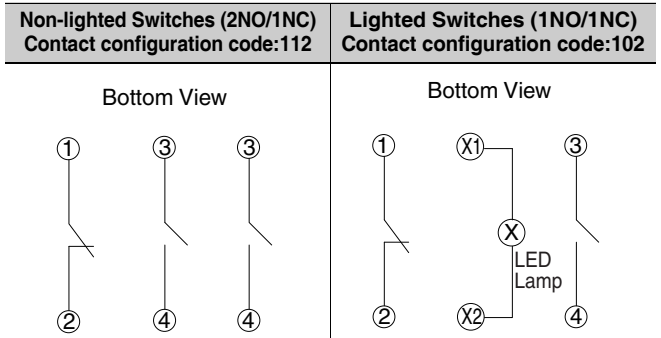

**Note:** The above shows a terminal connection diagram for a screw terminal block type.

### BOTTOM VIEW (Push-In Plus terminal block type)

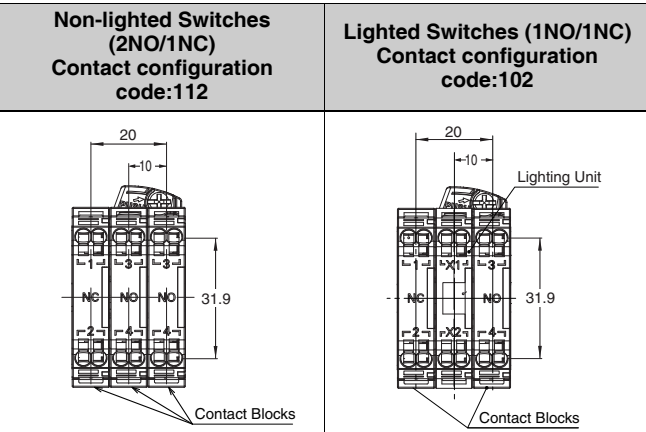

### Double-contact unit Non-lighted (2NO/2NO/2NC)

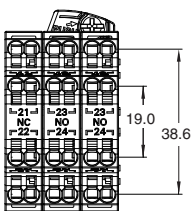

Pushbutton Switches  
A22N

Selector Switches  
A22N

Key-Type Selector Switches  
A22N

Indicators  
M22N

Pushbutton Switches  
A30N

Selector Switches  
A30N

Key-Type Selector Switches  
A30N

Subassemblies  
(Common)

Accessories  
and Tools

Safety  
Precautions



# Selector Switches A22NS/A22NW

**22-mm dia. Knob-type Selector Switches**  
**Control panel miniaturization through a more compact design and modified wiring direction.**  
**Addition of Push-In Plus terminal blocks for easy wiring.**



### Easy to Use

- Improved wiring visibility through to a modified wiring direction. (Push-In Plus terminal block type)
- Screw terminal structure is compatible with round crimp terminals. (Screw terminal block type)
- The terminals can be secured even when a contact block is mounted. (Screw terminal block type)

### Miniaturization

- No need for extra lateral space because of the modified wiring direction. (Push-In Plus terminal block type)
- Compact design.
- A22NW (lighted models) are the same size as A22NS (non-lighted models).

### Safety

- Easy-to-operate lock lever for secure locking.
- Easy-mounting Contact Blocks provide finger protection.
- No loose connections of wiring means maintenance-free use. (Push-In Plus terminal block type)

### Product Lineup

- Meets global safety standards.
- Can be installed in two types of panel hole dimensions: 22.3 and 25.5 dia.
- The buttons and bezels come in a wide variety of colors, shapes, and materials.
- Standard-feature degree of protection: IP66, NEMA 4X, and NEMA 13.

Refer to *Safety Precautions for All Pushbutton Switches/Indicators and Safety Precautions* on page 88.













## Operation Unit Colors

		Red	Green	Yellow	White	Blue	Black	
Non-lighted Switches	A22NS-□□□-N□ Opaque							
Lighted Switches	A22NW-□□□-T□ Transparent	When not lit						
		When lit						

\* The colors when the Switches are lit are for transparent white Operation Units (code: TW) and yellow LED Lamps (code: Y).

Pushbutton Switches A22N  
 Selector Switches A22N  
 Key-type Selector Switches A22N  
 Indicators M22N  
 Pushbutton Switches A30N  
 Selector Switches A30N  
 Key-type Selector Switches A30N  
 Subassemblies (Common)  
 Accessories and Tools  
 Safety Precautions

List of Models

Screw Terminal Blocks/Push-In Plus Terminal Blocks			
Plastic bezels			
A22NS-□B		A22NW-□B	
Non-lighted Two Positions	Three Positions	Lighted Two Positions	Three Positions
			
Screw Terminal Blocks/Push-In Plus Terminal Blocks			
Brushed Metal bezels			
A22NS-□M		A22NW-□M	
Non-lighted Two Positions	Three Positions	Lighted Two Positions	Three Positions
			
Screw Terminal Blocks/Push-In Plus Terminal Blocks			
Metal bezels			
A22NS-□R		A22NW-□R	
Non-lighted Two Positions	Three Positions	Lighted Two Positions	Three Positions
			

Pushbutton Switches  
A22N

Selector Switches  
A22N

Key-type Selector Switches  
A22N

Indicators  
M22N

Pushbutton Switches  
A30N

Selector Switches  
A30N

Key-type Selector Switches  
A30N

Subassemblies  
(Common)

Accessories  
and Tools

Safety  
Precautions

# A22NS/A22NW

## Model Number Structure

### Model Number Legend

-- Shipped as a set that includes the Operation Unit, LED Lamp (lighted models only), Mounting Collar, Contact Block, and Lighting Unit (lighted models only).  
For information on combinations, refer to *Ordering Information* on pages 25 to 27.

### Model Numbers for Sets

A 22 N <sup>(1)</sup> W - <sup>(2)</sup> 2 <sup>(3)</sup> B <sup>(4)</sup> M <sup>(5)</sup> - <sup>(6)</sup> N <sup>(7)</sup> R <sup>(8)</sup> A - <sup>(9)</sup> G 1 0 1 - <sup>(8)</sup> R <sup>(9)</sup> A

#### (1) Type

Code	Type
S	Non-lighted
W	Lighted

#### (5) Degree of Protection

Code	Protection
A	Conforming to IP66, NEMA 4X, NEMA13

#### (6) Contacts and Terminals Specifications

Code	Specification
G	General/Screw Terminal Block
P	General/Push-In Plus Terminal Block

#### (2) Number of Positions and Bezel Material

Code	No. of positions	Bezel material
2B	2	Plastic
2M	2	Brushed metal
2R	2	Metal
3B	3	Plastic
3M	3	Brushed metal
3R	3	Metal

#### (7) Contact Configuration

Code	Contact Blocks		Non-lighted						Lighted				
			Unit position			No. of positions			Unit position			No. of positions	
			NO	NC	1	2	3	Two positions	Three positions	1	2	3	Two positions
100	1	0	NO	---	---	Yes		NO	Lighting Unit	---	Yes		
002	0	1	---	---	NC	Yes		---	Lighting Unit	NC	Yes		
101	2	0	NO	---	NO	Yes	Yes	NO	Lighting Unit	NO	Yes	Yes	
102	1	1	NO	---	NC	Yes	Yes	NO	Lighting Unit	NC	Yes	Yes	
201	1	1	NC	---	NO		Yes	NC	Lighting Unit	NO		Yes	
202	0	2	NC	---	NC	Yes	Yes	NC	Lighting Unit	NC	Yes	Yes	
110	2	0	NO	NO	---		Yes						
111	3	0	NO	NO	NO	Yes	Yes						
112	2	1	NO	NO	NC	Yes	Yes						
210	1	1	NC	NO	---		Yes						
211	2	1	NC	NO	NO		Yes						
212	1	2	NC	NO	NC		Yes						
011	2	0	---	NO	NO		Yes						
012	1	1	---	NO	NC		Yes						
120	1	1	NO	NC	---		Yes						
121	2	1	NO	NC	NO		Yes						
122	1	2	NO	NC	NC	Yes	Yes						
220	0	2	NC	NC	---		Yes						
221	1	2	NC	NC	NO		Yes						
222	0	3	NC	NC	NC	Yes	Yes						
021	1	1	---	NC	NO		Yes						
022	0	2	---	NC	NC		Yes						

#### (3) Reset Method

Code	Reset method		
M	Manual	Two-position manual	
		Three-position manual	
L	Automatic reset on left	Two-position automatic	
		Three-position left automatic	
R	Automatic reset on right	Three-position right automatic	
B	Automatic reset on left and right	Three-position left or right automatic	

#### (4) Operation Unit Transparency and Color and (8) LED Lamp Color

Lighted/non-lighted	Code (4)	Code (8)	Transparency	Operation Unit color	LED Lamp color
Non-lighted	NR	N	Opaque	Red	---
	NG				
	NY				
	NW				
	NA				
	NB				
Lighted	TR	R	Transparent	Red	Red
	TG	G		Green	Green
	TY	Y		Yellow	Yellow
	TW	W		White	White
	TA	A		Blue	Blue
	TO	O		Orange	Orange
	TW	Y		White*	Yellow

**Note:** 1. NO (blue): Normally open, NC (orange): Normally closed.  
2. Refer to the following figure for the Unit positions.

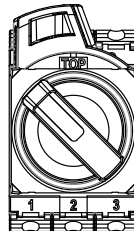

#### (9) LED Lamp Voltage

Code	LED Lamp voltage
N	Non-lighted
A	6 VAC/DC
B	12 VAC/DC
C	24 VAC/DC
D	100/110/120 VAC
E	200/220/230/240 VAC

\* The color is opaque white when the Switch is lit.

■ Specifications: Refer to page 13  
■ Dimensions: Refer to page 33.

■ Characteristics: Refer to page 32.  
■ Precautions for correct use: Refer to pages 88 to 99.

# Structure

## Contact Configuration Table

### Two Positions

No. of outputs	Code	Contact configuration	Unit position	Contacts	Position	
					1	2
1	100	SPST-NO	1	NO		ON
			2	---	---	---
			3	---	---	---
1	002	SPST-NC	1	---	---	---
			2	---	---	---
			3	NC	ON	
2	102	SPST-NO/ SPST-NC	1	NO		ON
			2	---	---	---
			3	NC	ON	
2	101	DPST-NO	1	NO		ON
			2	---	---	---
			3	NO		ON
2	202	DPST-NC	1	NC	ON	
			2	---	---	---
			3	NC	ON	
3	111	3PST-NO	1	NO		ON
			2	NO		ON
			3	NO		ON
3	222	3PST-NC	1	NC	ON	
			2	NC	ON	
			3	NC	ON	
3	122	SPST-NO/ DPST-NC	1	NO		ON
			2	NC	ON	
			3	NC	ON	
3	112	DPST-NO/ SPST-NC	1	NO		ON
			2	NO		ON
			3	NC	ON	

### Three Positions

No. of outputs	Code	Contact configuration	Unit position	Contacts	Position		
					1	0	2
2	110	DPST-NO	1	NO	ON		
			2	NO	ON		ON
			3	---	---	---	---
2	011	DPST-NO	1	---	---	---	---
			2	NO	ON		ON
			3	NO			ON
2	101	DPST-NO	1	NO	ON		
			2	---	---	---	---
			3	NO			ON
2	220	DPST-NC	1	NC		ON	ON
			2	NC		ON	
			3	---	---	---	---
2	022	DPST-NC	1	---	---	---	---
			2	NC		ON	
			3	NC	ON	ON	

## Operation Angle

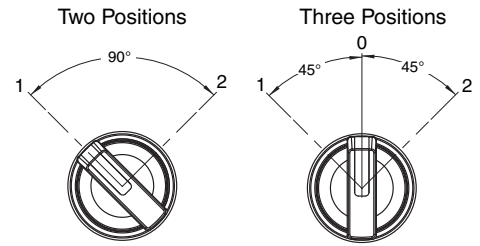

Pushbutton Switches  
A22N

Selector Switches  
A22N

Key-type Selector Switches  
A22N

Indicators  
M22N

Pushbutton Switches  
A30N

Selector Switches  
A30N

Key-type Selector Switches  
A30N

Subassemblies  
(Common)

Accessories  
and Tools

Safety  
Precautions

# A22NS/A22NW

## Operation Angle

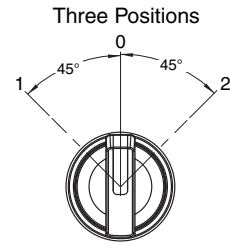



No. of outputs	Code	Contact configuration	Unit position	Contacts	Position		
					1	0	2
2	202	DPST-NC	1	NC		ON	ON
			2	---	---	---	---
			3	NC	ON	ON	
2	120	SPST-NO/ SPST-NC	1	NO	ON		
			2	NC		ON	
			3	---	---	---	---
2	102	SPST-NO/ SPST-NC	1	NO	ON		
			2	---	---	---	---
			3	NC	ON	ON	
2	210	SPST-NO/ SPST-NC	1	NC		ON	ON
			2	NO	ON		ON
			3	---	---	---	---
2	201	SPST-NO/ SPST-NC	1	NC		ON	ON
			2	---	---	---	---
			3	NO			ON
2	012	SPST-NO/ SPST-NC	1	---	---	---	---
			2	NO	ON		ON
			3	NC	ON	ON	
2	021	SPST-NO/ SPST-NC	1	---	---	---	---
			2	NC		ON	
			3	NO			ON
3	111	3PST-NO	1	NO	ON		
			2	NO			ON
			3	NO			ON
3	222	3PST-NC	1	NC		ON	ON
			2	NC		ON	
			3	NC	ON	ON	
3	122	SPST-NO/ DPST-NC	1	NO	ON		
			2	NC		ON	
			3	NC	ON	ON	
3	212	SPST-NO/ DPST-NC	1	NC		ON	ON
			2	NO	ON		ON
			3	NC	ON	ON	
3	221	SPST-NO/ DPST-NC	1	NC		ON	ON
			2	NC		ON	
			3	NO	ON		ON
3	211	DPST-NO/ SPST-NC	1	NC		ON	ON
			2	NO	ON		ON
			3	NO			ON
3	121	DPST-NO/ SPST-NC	1	NO	ON		
			2	NC		ON	
			3	NO			ON
3	112	DPST-NO/ SPST-NC	1	NO	ON		
			2	NO	ON		ON
			3	NC	ON	ON	



# Ordering Information

**Model Numbers for Sets** --- Shipped as a set that includes the Operation Unit, Mounting Collar, and Contact Block.  
**Non-lighted, Two-position, Selector Switches**

Appearance	Bezel material	No. of outputs	Model	(3) Reset method	(4)(4) Operation Unit color	(7)(7)(7) Contact configuration		
Plastic bezels 	2B	1	A22NS-2B(3)-(4)(4)A-G(7)(7)(7)-NN	M: Manual L: Automatic reset on left	NR: Opaque red NG: Opaque green NY: Opaque yellow NW: Opaque white NA: Opaque blue NB: Opaque black	100 002		
			A22NS-2B(3)-(4)(4)A-P(7)(7)(7)-NN					
		2	A22NS-2B(3)-(4)(4)A-G(7)(7)(7)-NN			102 101 202		
			A22NS-2B(3)-(4)(4)A-P(7)(7)(7)-NN					
		3	A22NS-2B(3)-(4)(4)A-G(7)(7)(7)-NN			111 222 122 112		
			A22NS-2B(3)-(4)(4)A-P(7)(7)(7)-NN					
Brushed metal bezels 	2M	1	A22NS-2M(3)-(4)(4)A-G(7)(7)(7)-NN			M: Manual L: Automatic reset on left	NR: Opaque red NG: Opaque green NY: Opaque yellow NW: Opaque white NA: Opaque blue NB: Opaque black	100 002
			A22NS-2M(3)-(4)(4)A-P(7)(7)(7)-NN					
		2	A22NS-2M(3)-(4)(4)A-G(7)(7)(7)-NN					102 101 202
			A22NS-2M(3)-(4)(4)A-P(7)(7)(7)-NN					
		3	A22NS-2M(3)-(4)(4)A-G(7)(7)(7)-NN					111 222 122 112
			A22NS-2M(3)-(4)(4)A-P(7)(7)(7)-NN					
Metal bezels 	2R	1	A22NS-2R(3)-(4)(4)A-G(7)(7)(7)-NN	M: Manual L: Automatic reset on left	NR: Opaque red NG: Opaque green NY: Opaque yellow NW: Opaque white NA: Opaque blue NB: Opaque black			100 002
			A22NS-2R(3)-(4)(4)A-P(7)(7)(7)-NN					
		2	A22NS-2R(3)-(4)(4)A-G(7)(7)(7)-NN					102 101 202
			A22NS-2R(3)-(4)(4)A-P(7)(7)(7)-NN					
		3	A22NS-2R(3)-(4)(4)A-G(7)(7)(7)-NN					111 222 122 112
			A22NS-2R(3)-(4)(4)A-P(7)(7)(7)-NN					

Pushbutton Switches  
A22N

Selector Switches  
A22N

Key-type Selector Switches  
A22N

Indicators  
M22N

Pushbutton Switches  
A30N

Selector Switches  
A30N

Key-type Selector Switches  
A30N



Subassemblies  
(Common)

Accessories  
and Tools

Safety  
Precautions

# A22NS/A22NW

## Non-lighted, Three-position, Selector Switches



Appearance	Bezel material	No. of outputs	Model	(3) Reset method	(4)(4) Operation Unit color	(7)(7)(7) Contact configuration
Plastic bezels 	3B	2	A22NS-3B(3)-(4)(4)A-G(7)(7)-NN	M: Manual L: Automatic reset on left R: Automatic reset on right B: Automatic reset on left and right	NR: Opaque red NG: Opaque green NY: Opaque yellow NW: Opaque white NA: Opaque blue NB: Opaque black	110
			011			
		3	A22NS-3B(3)-(4)(4)A-P(7)(7)-NN			101
			220			
	3M	A22NS-3B(3)-(4)(4)A-G(7)(7)-NN	022			
		A22NS-3B(3)-(4)(4)A-P(7)(7)-NN	202			
Brushed metal bezels 	3M	2	A22NS-3M(3)-(4)(4)A-G(7)(7)-NN	120		
			102			
		3	A22NS-3M(3)-(4)(4)A-P(7)(7)-NN	210		
			A22NS-3M(3)-(4)(4)A-P(7)(7)-NN	201		
	Metal bezels 	3R	2	A22NS-3R(3)-(4)(4)A-G(7)(7)-NN	012	
				021		
3			A22NS-3R(3)-(4)(4)A-G(7)(7)-NN	111		
			A22NS-3R(3)-(4)(4)A-P(7)(7)-NN	222		

Pushbutton Switches A22N  
 Selector Switches A22N  
 Key-type Selector Switches A22N  
 Indicators M22N  
 Pushbutton Switches A30N  
 Selector Switches A30N  
 Key-type Selector Switches A30N  
 Subassemblies (Common)  
 Accessories and Tools  
 Safety Precautions



# Ordering Information

**Model Numbers for Sets** - - - Shipped as a set that includes the Operation Unit, LED Lamp, Mounting Collar, Contact Block, and Lighting Unit.

## Lighted, Two-position, Selector Switches

Appearance	Bezel material	No. of outputs	Model	(3) Reset method	(4)(4) Operation Unit color	(7)(7)(7) Contact Configuration	(8) LED Lamp color	(9) LED Lamp voltage				
Plastic bezels 	2B	1	A22NW-2B(3)-(4)(4)A-G(7)(7)-(8)(9)	M: Manual L: Automatic reset on left	TR: Transparent red TG: Transparent green TY: Transparent yellow TW: Transparent white TA: Transparent blue TO: Transparent orange	100 002	R: Red G: Green Y: Yellow A: Blue O: Orange W: White	A: 6 VAC/DC B: 12 VAC/DC C: 24 VAC/DC D: 100/110/120 VAC E: 200/220/230/240 VAC				
			A22NW-2B(3)-(4)(4)A-P(7)(7)-(8)(9)						102 101 202			
		2	A22NW-2B(3)-(4)(4)A-G(7)(7)-(8)(9)			100 002						
			A22NW-2B(3)-(4)(4)A-P(7)(7)-(8)(9)						102 101 202			
Brushed metal bezels 	2M	1	A22NW-2M(3)-(4)(4)A-G(7)(7)-(8)(9)			M: Manual L: Automatic reset on left				TR: Transparent red TG: Transparent green TY: Transparent yellow TW: Transparent white TA: Transparent blue TO: Transparent orange	100 002	R: Red G: Green Y: Yellow A: Blue O: Orange W: White
			A22NW-2M(3)-(4)(4)A-P(7)(7)-(8)(9)						102 101 202			
		2	A22NW-2M(3)-(4)(4)A-G(7)(7)-(8)(9)								100 002	
			A22NW-2M(3)-(4)(4)A-P(7)(7)-(8)(9)						102 101 202			
Metal bezels 	2R	1	A22NW-2R(3)-(4)(4)A-G(7)(7)-(8)(9)	M: Manual L: Automatic reset on left	TR: Transparent red TG: Transparent green TY: Transparent yellow TW: Transparent white TA: Transparent blue TO: Transparent orange		100 002	R: Red G: Green Y: Yellow A: Blue O: Orange W: White			A: 6 VAC/DC B: 12 VAC/DC C: 24 VAC/DC D: 100/110/120 VAC E: 200/220/230/240 VAC	
			A22NW-2R(3)-(4)(4)A-P(7)(7)-(8)(9)						102 101 202			
		2	A22NW-2R(3)-(4)(4)A-G(7)(7)-(8)(9)				100 002					
			A22NW-2R(3)-(4)(4)A-P(7)(7)-(8)(9)						102 101 202			

## Lighted, Three-position, Selector Switches

Appearance	Bezel material	No. of outputs	Model	(3) Reset method	(4)(4) Operation Unit color	(7)(7)(7) Contact Configuration	(8) LED Lamp color	(9) LED Lamp voltage								
Plastic bezels 	3B	2	A22NW-3B(3)-(4)(4)A-G(7)(7)-(8)(9)	M: Manual L: Automatic reset on left R: Automatic reset on right B: Automatic reset on left and right	TR: Transparent red TG: Transparent green TY: Transparent yellow TW: Transparent white TA: Transparent blue TO: Transparent orange	101 202 102 201	R: Red G: Green Y: Yellow A: Blue O: Orange W: White	A: 6 VAC/DC B: 12 VAC/DC C: 24 VAC/DC D: 100/110/120 VAC E: 200/220/230/240 VAC								
			A22NW-3B(3)-(4)(4)A-P(7)(7)-(8)(9)						101 202 102 201							
Brushed metal bezels 	3M	2	A22NW-3M(3)-(4)(4)A-G(7)(7)-(8)(9)			M: Manual L: Automatic reset on left R: Automatic reset on right B: Automatic reset on left and right				TR: Transparent red TG: Transparent green TY: Transparent yellow TW: Transparent white TA: Transparent blue TO: Transparent orange	101 202 102 201	R: Red G: Green Y: Yellow A: Blue O: Orange W: White	A: 6 VAC/DC B: 12 VAC/DC C: 24 VAC/DC D: 100/110/120 VAC E: 200/220/230/240 VAC			
			A22NW-3M(3)-(4)(4)A-P(7)(7)-(8)(9)						101 202 102 201							
Metal bezels 	3R	2	A22NW-3R(3)-(4)(4)A-G(7)(7)-(8)(9)								M: Manual L: Automatic reset on left R: Automatic reset on right B: Automatic reset on left and right			TR: Transparent red TG: Transparent green TY: Transparent yellow TW: Transparent white TA: Transparent blue TO: Transparent orange	101 202 102 201	R: Red G: Green Y: Yellow A: Blue O: Orange W: White
			A22NW-3R(3)-(4)(4)A-P(7)(7)-(8)(9)						101 202 102 201							

**Note:** Normally, the Operation Unit and LED Lamp with the same color are combined. However, opaque white is available by combining a white Operation Unit and yellow LED. A22N□-□□□-TWA-□□□□-Y□

■ Subassemblies: Refer to pages 28 to 30 and 82. (You can order Operation Units, LED Lamps, Mounting Collars, and Contact Blocks individually.)

■ Specifications: Refer to page 13 ■ Characteristics: Refer to page 32.  
 ■ Dimensions: Refer to page 33.  
 ■ Accessories and tools: Refer to pages 84 to 85.

Pushbutton Switches A22N  
 Selector Switches A22N  
 Key-type Selector Switches A22N  
 Indicators M22N  
 Pushbutton Switches A30N  
 Selector Switches A30N  
 Key-type Selector Switches A30N  
 Subassemblies (Common)  
 Accessories and Tools  
 Safety Precautions

# Ordering Information

**Subassemblies** ----- You can order Operation Units, LED Lamps (lighted models only), Mounting Collars, Contact Blocks, and Lighting Units (lighted models only) separately. Use them in combination for models that are not available as assembled Switches. They can also be used as inventory for maintenance parts.

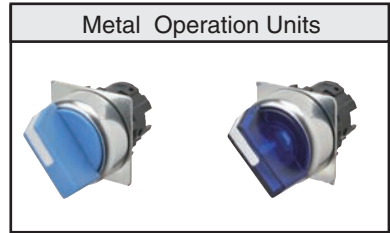
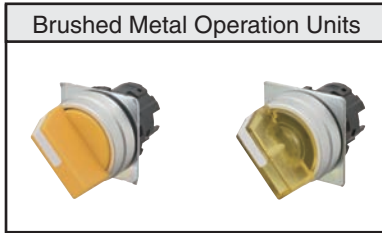
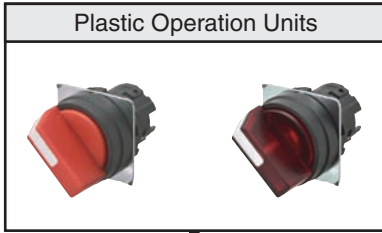

Non-lighted models

Lighted models

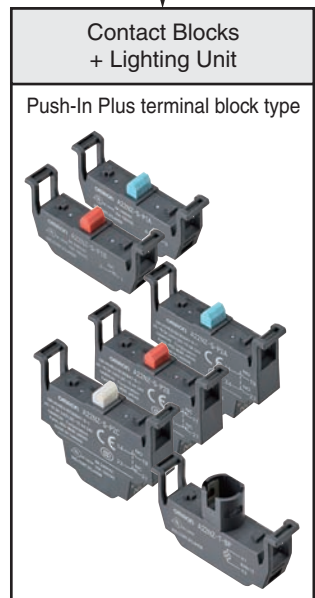
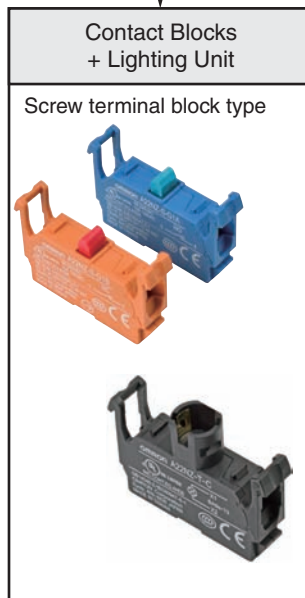
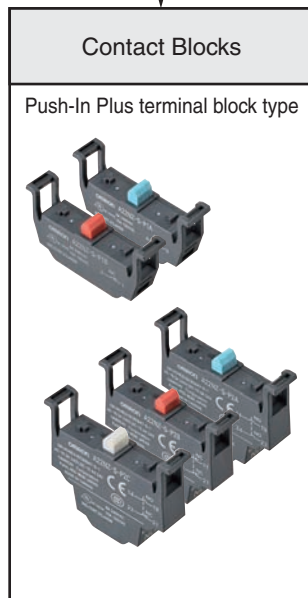
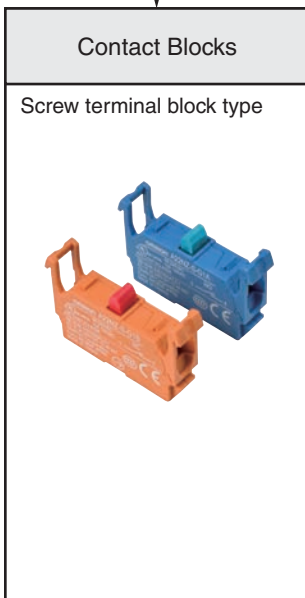

- Model numbers of sets: Refer to pages 25 to 27.
- Specifications: Refer to page 13.
- Characteristics: Refer to page 32.

- Dimensions: Refer to page 33.
- Subassemblies (Common): Refer to page 82.
- Accessories and tools: Refer to pages 84 to 85.

Pushbutton Switches  
A22N

Selector Switches  
A22N

Key-type Selector Switches  
A22N

Indicators  
M22N

Pushbutton Switches  
A30N

Selector Switches  
A30N

Key-type Selector Switches  
A30N

Subassemblies (Common)





Accessories and Tools

Safety Precautions

# Ordering Information

**Subassemblies** - - - - You can order Operation Units, Mounting Collars, and Contact Blocks individually. Use them in combination for models that are not available as assembled Switches. They can also be used as inventory for maintenance parts.

## Operation Unit Non-lighted Switches

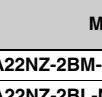
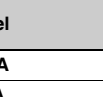
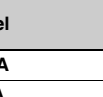
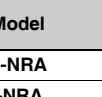
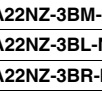
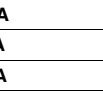
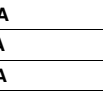
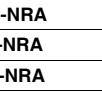
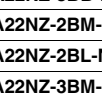
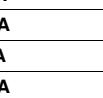
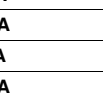
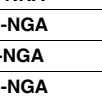
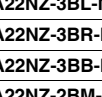
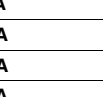
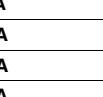
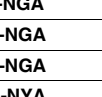
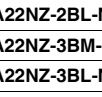
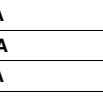
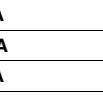
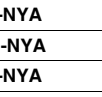
No. of positions	Reset method	Operation Unit color	Bezel material and shape		Model	Model	Model
			Plastic	Brushed metal			
2	Manual	Opaque red			A22NZ-2BM-NRA	A22NZ-2MM-NRA	A22NZ-2RM-NRA
	Automatic reset on left				A22NZ-2BL-NRA	A22NZ-2ML-NRA	A22NZ-2RL-NRA
3	Manual		A22NZ-3BM-NRA	A22NZ-3MM-NRA	A22NZ-3RM-NRA		
	Automatic reset on left		A22NZ-3BL-NRA	A22NZ-3ML-NRA	A22NZ-3RL-NRA		
	Automatic reset on right		A22NZ-3BR-NRA	A22NZ-3MR-NRA	A22NZ-3RR-NRA		
	Automatic reset on left and right		A22NZ-3BB-NRA	A22NZ-3MB-NRA	A22NZ-3RB-NRA		
2	Manual	Opaque green			A22NZ-2BM-NGA	A22NZ-2MM-NGA	A22NZ-2RM-NGA
	Automatic reset on left				A22NZ-2BL-NGA	A22NZ-2ML-NGA	A22NZ-2RL-NGA
3	Manual		A22NZ-3BM-NGA	A22NZ-3MM-NGA	A22NZ-3RM-NGA		
	Automatic reset on left		A22NZ-3BL-NGA	A22NZ-3ML-NGA	A22NZ-3RL-NGA		
	Automatic reset on right		A22NZ-3BR-NGA	A22NZ-3MR-NGA	A22NZ-3RR-NGA		
	Automatic reset on left and right		A22NZ-3BB-NGA	A22NZ-3MB-NGA	A22NZ-3RB-NGA		
2	Manual	Opaque yellow			A22NZ-2BM-NYA	A22NZ-2MM-NYA	A22NZ-2RM-NYA
	Automatic reset on left				A22NZ-2BL-NYA	A22NZ-2ML-NYA	A22NZ-2RL-NYA
3	Manual		A22NZ-3BM-NYA	A22NZ-3MM-NYA	A22NZ-3RM-NYA		
	Automatic reset on left		A22NZ-3BL-NYA	A22NZ-3ML-NYA	A22NZ-3RL-NYA		
	Automatic reset on right		A22NZ-3BR-NYA	A22NZ-3MR-NYA	A22NZ-3RR-NYA		
	Automatic reset on left and right		A22NZ-3BB-NYA	A22NZ-3MB-NYA	A22NZ-3RB-NYA		
2	Manual	Opaque white			A22NZ-2BM-NWA	A22NZ-2MM-NWA	A22NZ-2RM-NWA
	Automatic reset on left				A22NZ-2BL-NWA	A22NZ-2ML-NWA	A22NZ-2RL-NWA
3	Manual		A22NZ-3BM-NWA	A22NZ-3MM-NWA	A22NZ-3RM-NWA		
	Automatic reset on left		A22NZ-3BL-NWA	A22NZ-3ML-NWA	A22NZ-3RL-NWA		
	Automatic reset on right		A22NZ-3BR-NWA	A22NZ-3MR-NWA	A22NZ-3RR-NWA		
	Automatic reset on left and right		A22NZ-3BB-NWA	A22NZ-3MB-NWA	A22NZ-3RB-NWA		
2	Manual	Opaque blue			A22NZ-2BM-NAA	A22NZ-2MM-NAA	A22NZ-2RM-NAA
	Automatic reset on left				A22NZ-2BL-NAA	A22NZ-2ML-NAA	A22NZ-2RL-NAA
3	Manual		A22NZ-3BM-NAA	A22NZ-3MM-NAA	A22NZ-3RM-NAA		
	Automatic reset on left		A22NZ-3BL-NAA	A22NZ-3ML-NAA	A22NZ-3RL-NAA		
	Automatic reset on right		A22NZ-3BR-NAA	A22NZ-3MR-NAA	A22NZ-3RR-NAA		
	Automatic reset on left and right		A22NZ-3BB-NAA	A22NZ-3MB-NAA	A22NZ-3RB-NAA		
2	Manual	Opaque black			A22NZ-2BM-NBA	A22NZ-2MM-NBA	A22NZ-2RM-NBA
	Automatic reset on left				A22NZ-2BL-NBA	A22NZ-2ML-NBA	A22NZ-2RL-NBA
3	Manual		A22NZ-3BM-NBA	A22NZ-3MM-NBA	A22NZ-3RM-NBA		
	Automatic reset on left		A22NZ-3BL-NBA	A22NZ-3ML-NBA	A22NZ-3RL-NBA		
	Automatic reset on right		A22NZ-3BR-NBA	A22NZ-3MR-NBA	A22NZ-3RR-NBA		
	Automatic reset on left and right		A22NZ-3BB-NBA	A22NZ-3MB-NBA	A22NZ-3RB-NBA		

- Model numbers of sets: Refer to pages 25 to 27.
- Specifications: Refer to page 13.
- Characteristics: Refer to page 32.

- Dimensions: Refer to page 33.
- Subassemblies (Common): Refer to page 82.
- Accessories and tools: Refer to pages 84 to 85.

Pushbutton Switches  
A22N

Selector Switches  
A22N

Key-type Selector Switches  
A22N

Indicators  
M22N

Pushbutton Switches  
A30N

Selector Switches  
A30N

Key-type Selector Switches  
A30N

Subassemblies (Common)

Accessories and Tools

Safety Precautions



# A22NS/A22NW

## Ordering Information

### Subassemblies

----- You can order Operation Units, LED Lamps, Mounting Collars, Contact Blocks, and Lighting Units separately. Use them in combination for models that are not available as assembled Switches. They can also be used as inventory for maintenance parts.

### Lighted Switches

Bezel material and shape			Plastic	Brushed metal	Metal	
						
No. of positions	Reset method	Operation Unit color	Model	Model	Model	
2	Manual	Transparent red	A22NZ-2BM-TRA	A22NZ-2MM-TRA	A22NZ-2RM-TRA	
	Automatic reset on left		A22NZ-2BL-TRA	A22NZ-2ML-TRA	A22NZ-2RL-TRA	
3	Manual		A22NZ-3BM-TRA	A22NZ-3MM-TRA	A22NZ-3RM-TRA	
	Automatic reset on left		A22NZ-3BL-TRA	A22NZ-3ML-TRA	A22NZ-3RL-TRA	
	Automatic reset on right		A22NZ-3BR-TRA	A22NZ-3MR-TRA	A22NZ-3RR-TRA	
	Automatic reset on left and right		A22NZ-3BB-TRA	A22NZ-3MB-TRA	A22NZ-3RB-TRA	
2	Manual		Transparent green	A22NZ-2BM-TGA	A22NZ-2MM-TGA	A22NZ-2RM-TGA
	Automatic reset on left			A22NZ-2BL-TGA	A22NZ-2ML-TGA	A22NZ-2RL-TGA
3	Manual			A22NZ-3BM-TGA	A22NZ-3MM-TGA	A22NZ-3RM-TGA
	Automatic reset on left			A22NZ-3BL-TGA	A22NZ-3ML-TGA	A22NZ-3RL-TGA
	Automatic reset on right			A22NZ-3BR-TGA	A22NZ-3MR-TGA	A22NZ-3RR-TGA
	Automatic reset on left and right			A22NZ-3BB-TGA	A22NZ-3MB-TGA	A22NZ-3RB-TGA
2	Manual	Transparent yellow		A22NZ-2BM-TYA	A22NZ-2MM-TYA	A22NZ-2RM-TYA
	Automatic reset on left			A22NZ-2BL-TYA	A22NZ-2ML-TYA	A22NZ-2RL-TYA
3	Manual			A22NZ-3BM-TYA	A22NZ-3MM-TYA	A22NZ-3RM-TYA
	Automatic reset on left			A22NZ-3BL-TYA	A22NZ-3ML-TYA	A22NZ-3RL-TYA
	Automatic reset on right			A22NZ-3BR-TYA	A22NZ-3MR-TYA	A22NZ-3RR-TYA
	Automatic reset on left and right			A22NZ-3BB-TYA	A22NZ-3MB-TYA	A22NZ-3RB-TYA
2	Manual		Transparent white	A22NZ-2BM-TWA	A22NZ-2MM-TWA	A22NZ-2RM-TWA
	Automatic reset on left			A22NZ-2BL-TWA	A22NZ-2ML-TWA	A22NZ-2RL-TWA
3	Manual			A22NZ-3BM-TWA	A22NZ-3MM-TWA	A22NZ-3RM-TWA
	Automatic reset on left			A22NZ-3BL-TWA	A22NZ-3ML-TWA	A22NZ-3RL-TWA
	Automatic reset on right			A22NZ-3BR-TWA	A22NZ-3MR-TWA	A22NZ-3RR-TWA
	Automatic reset on left and right			A22NZ-3BB-TWA	A22NZ-3MB-TWA	A22NZ-3RB-TWA
2	Manual	Transparent blue		A22NZ-2BM-TAA	A22NZ-2MM-TAA	A22NZ-2RM-TAA
	Automatic reset on left			A22NZ-2BL-TAA	A22NZ-2ML-TAA	A22NZ-2RL-TAA
3	Manual			A22NZ-3BM-TAA	A22NZ-3MM-TAA	A22NZ-3RM-TAA
	Automatic reset on left			A22NZ-3BL-TAA	A22NZ-3ML-TAA	A22NZ-3RL-TAA
	Automatic reset on right			A22NZ-3BR-TAA	A22NZ-3MR-TAA	A22NZ-3RR-TAA
	Automatic reset on left and right			A22NZ-3BB-TAA	A22NZ-3MB-TAA	A22NZ-3RB-TAA
2	Manual		Transparent orange	A22NZ-2BM-TOA	A22NZ-2MM-TOA	A22NZ-2RM-TOA
	Automatic reset on left			A22NZ-2BL-TOA	A22NZ-2ML-TOA	A22NZ-2RL-TOA
3	Manual			A22NZ-3BM-TOA	A22NZ-3MM-TOA	A22NZ-3RM-TOA
	Automatic reset on left			A22NZ-3BL-TOA	A22NZ-3ML-TOA	A22NZ-3RL-TOA
	Automatic reset on right			A22NZ-3BR-TOA	A22NZ-3MR-TOA	A22NZ-3RR-TOA
	Automatic reset on left and right			A22NZ-3BB-TOA	A22NZ-3MB-TOA	A22NZ-3RB-TOA

- Model numbers of sets: Refer to pages 25 to 27.
- Specifications: Refer to page 13.
- Characteristics: Refer to page 32.

- Dimensions: Refer to page 33.
- Subassemblies (Common): Refer to page 82.
- Accessories and tools: Refer to pages 84 to 85.

## Specifications

### Certified Safety Standard Ratings

UL 508 (File No. E76675), CSA C22.2 No.14

6 A 240 VAC, 10 A 120 VAC

TÜV (EN60947-5-1)

AC-15 3 A 240 VAC

DC-13 4 A 24 VDC

CCC (GB14048.5)

AC-15 3 A 240 VAC

DC-13 4 A 24 VDC

### Application Standards

UL1059 and UL486E (Push-In Plus terminal block type)

### Ratings

#### Contacts (Standard Load)

Rated insulation voltage		600 V				
Rated carry current		10 A				
Rated voltage		24 V	120 V	240 V	380 V	440 V
AC at 50/60 Hz	Resistive load (AC-12)	10 A	10 A	6 A	2A	2 A
	Inductive load (AC-15)	10 A	6 A	3 A	1.9 A	1.6 A
DC	Resistive load (DC-12)	8 A	2.2 A	1.1 A	---	---
	Inductive load (DC-13)	4 A	1.1 A	0.55 A	---	---

**Note:** 1. The above ratings were obtained by conducting tests under the following conditions.

(1) Ambient temperature: 20 ±2°C

(2) Ambient humidity: 65% ±5% RH

(3) Operating frequency: 30 operations/minute

2. Minimum applicable load: 10 mA at 5 VDC.

### LED Lamps

Rated voltage	Applied voltage	Rated current
6 VAC/DC	6 VAC/DC ±10%	Approx. 11 mA (red, orange, yellow, or blue) Approx. 5 mA (white or green)
12 VAC/DC	12 VAC/DC ±10%	Approx. 12 mA (red, orange, yellow, or blue) Approx. 5 mA (white or green)
24 VAC/DC	24 VAC/DC ±10%	Approx. 12 mA (red, orange, yellow, or blue) Approx. 5 mA (white or green)
100 VAC	100 VAC ±10%	Approx. 12 mA (red, orange, yellow, or blue) Approx. 5 mA (white or green)
110 VAC	110 VAC ±10%	
120 VAC	100 to 130 VAC	Approx. 12 mA (red, orange, yellow, or blue) Approx. 5 mA (white or green)
200 VAC	200 VAC ±10%	
220 VAC	220 VAC ±10%	
230 VAC	230 VAC ±10%	
240 VAC	220 to 250 VAC	

# A22NS/A22NW

## Specifications

### Characteristics

Item	Type	Selector Switches	
		Non-lighted models	Lighted models
Allowable operating frequency	Mechanical	30 operations/minute max.	
	Electrical	30 operations/minute max.	
Insulation resistance		100 MΩ min. (at 500 VDC)	Not available for lighting units
Contact resistance		100 mΩ max. (initial value)	
Dielectric strength	Between terminals of same polarity	2,500 VAC at 50/60 Hz for 1 min. (initial value)	Not available for lighting units
	Between each terminal and ground	2,500 VAC at 50/60 Hz for 1 min. (initial value)	
Vibration resistance	Malfunction	10 to 55 Hz, 1.5-mm double amplitude (malfunction within 1 ms)	
Shock resistance	Malfunction	1,000 m/s <sup>2</sup> max. (malfunction within 1 ms)	
Durability	Mechanical	500,000 operations min. (Switches with 3 positions: 300,000 operations min.)	
	Electrical	500,000 operations min. (Switches with 3 positions: 300,000 operations min.) (250 VAC, 3 A, with an inductive load having power factor cos θ = 0.4)	
Ambient operating temperature <sup>*1</sup>		-25 to 70°C	-25 to 55°C
Ambient operating humidity		35% to 85% RH	
Ambient storage temperature <sup>*1</sup>		-40 to 80°C	
Degree of protection <sup>*2</sup>		Conforming to IP66, NEMA 4X, NEMA 13	
Electric shock protection class		Class II	
PTI (tracking characteristic)		175	
Degree of contamination (application environment)		3 (EN 60947-5-1)	
Weight		Approx. 50 g (for 1NC/1NO)	Approx. 60 g (for 1NC/1NO)

\*1. With no icing or condensation.

\*2. Degree of protection from the front of the panel.

### Operating Characteristics (for SPST-NO/SPST-NC)

Item	Type	Selector Switches	
		Manual reset	Automatic reset
Total travel force (torque) (maximum TTF)		0.6 N·m	0.6 N·m
Total travel (TT)		2 positions: Approx. 90°, 3 positions: Approx. 45°	
Resetting force (torque) (RF)		0.5 N·m max.	---

### Examples of Linked Contact Blocks (Screw terminal block type)

Contact Blocks

Lighting Units

	Selector Switches			
	2 positions		3 positions	
	Lighted	Non-lighted	Lighted	Non-lighted
Linking example				

\* If you use three Contact Blocks in stage 1, you can add one more Contact Block in the middle of stage 2.

**Note:** If you increase the number of Contact Blocks, evaluate the Switch under actual working conditions before permanent installation and use the Switch within a number of switching operations that will not adversely affect the Switch's performance.



Dimensions

Lighted and Non-lighted Selection Switches

Two-position Switches with Plastic Bezels  
A22N□-2B□-□□A-G

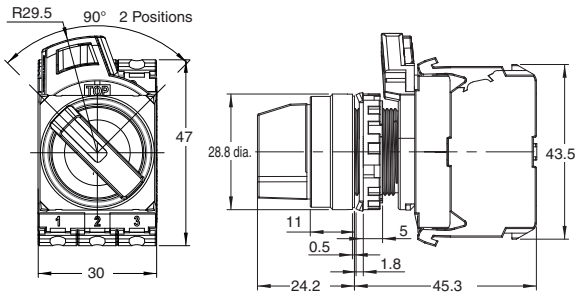
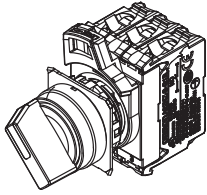

A22N□-2B□-□□A-P

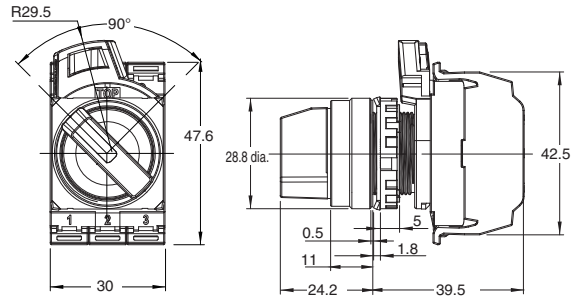
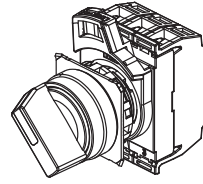

Three-position Switches with Plastic Bezels  
A22N□-3B□-□□A-G

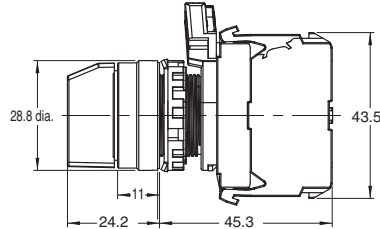
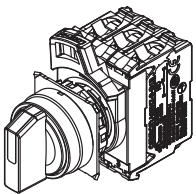

A22N□-3B□-□□A-P

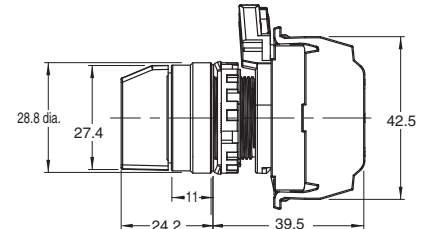
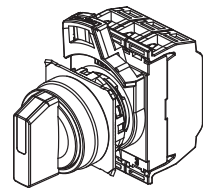

Two-position Switches with Brushed Metal Bezels  
A22N□-2M□-□□A-G

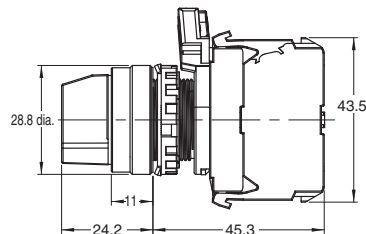
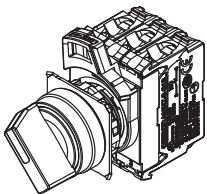

A22N□-2M□-□□A-P

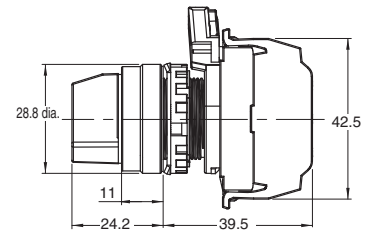
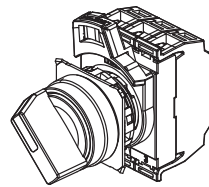

Three-position Switches with Brushed Metal Bezels  
A22N□-3M□-□□A-G

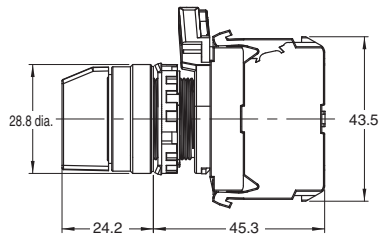
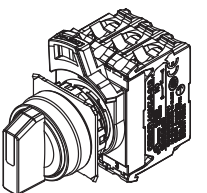

A22N□-3M□-□□A-P

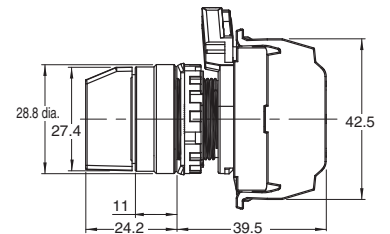
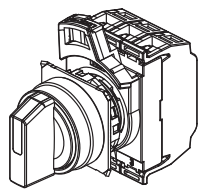

Pushbutton Switches  
A22N

Selector Switches  
A22N

Key-type Selector Switches  
A22N

Indicators  
M22N

Pushbutton Switches  
A30N

Selector Switches  
A30N

Key-type Selector Switches  
A30N

Subassemblies  
(Common)

Accessories  
and Tools

Safety  
Precautions

# A22NS/A22NW

Pushbutton Switches  
A22N

Selector Switches  
A22N

Key-Type Selector Switches  
A22N

Indicators  
M22N

Pushbutton Switches  
A30N

Selector Switches  
A30N

Key-Type Selector Switches  
A30N

Subassemblies  
(Common)

Accessories  
and Tools

Safety  
Precautions

## Two-position Switches with Metal Bezels

A22N□-2R□-□□A-G

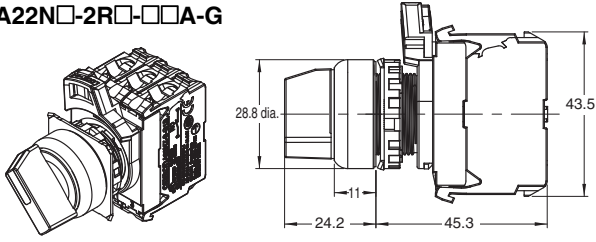

A22N□-2R□-□□A-P

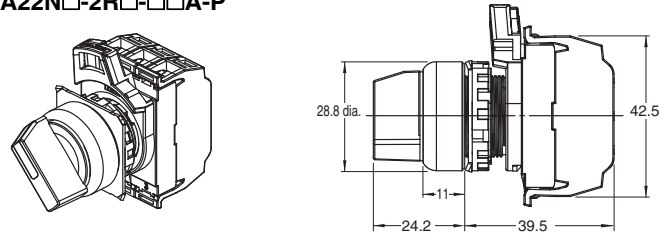

## Three-position Switches with Metal Bezels

A22N□-3R□-□□A-G

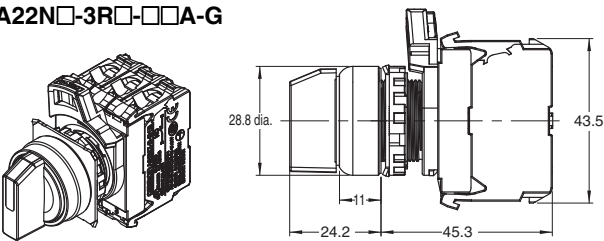

A22N□-3R□-□□A-P

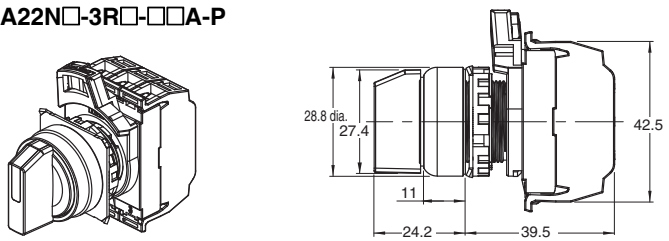

## Depth with Linked Units (Screw terminal block type)

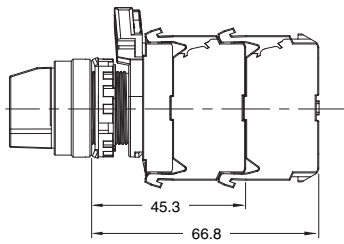

## Depth when a double-contact unit is mounted (Push-In Plus terminal block type)

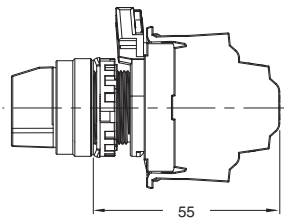

## Terminal Arrangement

### BOTTOM VIEW (Screw terminal block type)

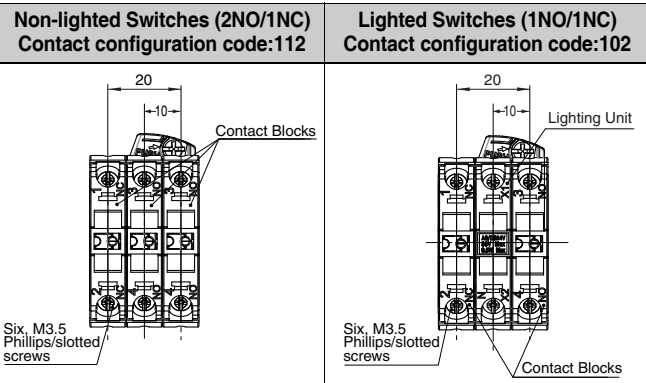

## Terminal Connection Diagrams

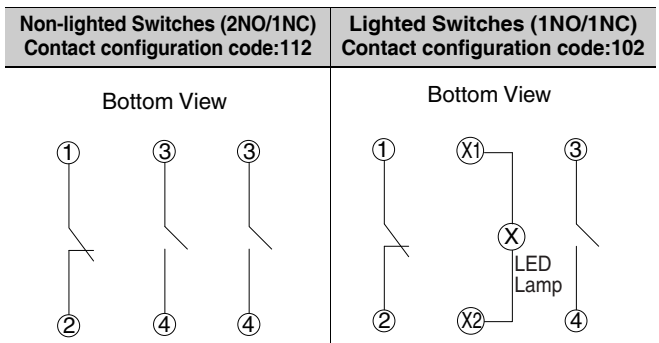

**Note:** The above shows a terminal connection diagram for a screw terminal block type.

### BOTTOM VIEW (Push-In Plus terminal block type)

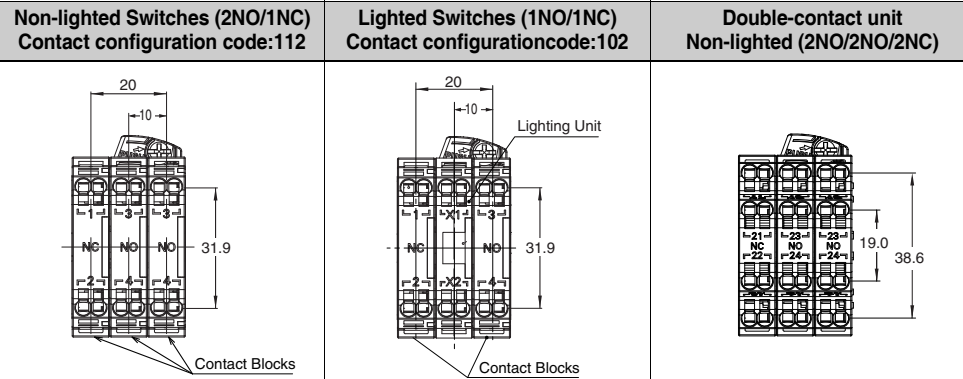

# Key-type Selector Switches A22NK

**22-mm dia. Key-type Selector Switches**  
**Control panel miniaturization through a more compact design and modified wiring direction.**  
**Addition of Push-In Plus terminal blocks for easy wiring.**



### Easy to Use

- You can connect up to three Contact Blocks in one stage for multistage expansion.
- Screw terminal structure is compatible with round crimp terminals. (Screw terminal block type)
- The terminals can be secured even when a contact block is mounted. (Screw terminal block type)
- Contact Blocks can be attached in any direction for easy assembly.

### Miniaturization

- No need for extra lateral space because of the modified wiring direction. (Push-In Plus terminal block type)
- Compact design.

### Safety

- Easy-to-operate lock lever for secure locking.
- Easy-mounting Contact Blocks provide finger protection.
- No loose connections of wiring means maintenance-free use. (Push-In Plus terminal block type)

### Product Lineup

- Meet global safety standards.
- Can be installed in two types of panel hole dimensions: 22.3 and 25.5 dia.
- The buttons and bezels come in a wide variety of colors, shapes, and materials.
- Standard-feature degree of protection: IP66 and NEMA 13.

Refer to *Safety Precautions for All Pushbutton Switches/Indicators and Safety Precautions* on page 88.

## List of Models

Screw Terminal Blocks/Push-In Plus Terminal Blocks	
Plastic bezels	
A22NK-□B	

Two Positions



Three Positions



Screw Terminal Blocks/Push-In Plus Terminal Blocks	
Brushed metal bezels	
A22NK-□M	

Two Positions



Three Positions



Screw Terminal Blocks/Push-In Plus Terminal Blocks	
Metal bezels	
A22NK-□R	

Two Positions



Three Positions



Pushbutton Switches  
A22N

Selector Switches  
A22N

Key-type Selector Switches  
A22N

Indicators  
M22N

Pushbutton Switches  
A30N

Selector Switches  
A30N

Key-type Selector Switches  
A30N

Subassemblies  
(Common)

Accessories  
and Tools

Safety  
Precautions

# A22NK

## Model Number Structure

### Model Number Legend

----- Shipped as a set that includes the Operation Unit, Mounting Collar, and Contact Block.  
For information on combinations, refer to *Ordering Information* on pages 39 to 40.

### Model Numbers for Sets

A 2 2 N <sup>(1)</sup> **K** - <sup>(2)</sup> **2B** <sup>(3)</sup> **M** - <sup>(4)</sup> **01** <sup>(5)</sup> **A** <sup>(6)</sup> **A** - <sup>(7)</sup> **G** <sup>(8)</sup> **100**

#### (1) Type

Code	Type
K	Key-type Selector Switch

#### (4) Key Number

Code	No.
01	No.1

#### (2) Number of Positions and Bezel Material

Code	No. of positions	Bezel material
2B	2	Plastic
2M	2	Brushed metal
2R	2	Metal
3B	3	Plastic
3M	3	Brushed metal
3R	3	Metal

#### (5) Key Release Position \*

Code	Release position	Two positions	Three positions
A	All positions		
B	Left		
C	Right		
D	Center	---	
G	Left and right	---	

○: Release position    ●: Locked position  
\* The key can only be removed when in the free position for automatic reset models.

#### (3) Reset Method

Code	Reset method	
M	Manual	Two-positions manual
		Three-positions manual
L	Automatic reset on left	Two-positions automatic
		Three-positions left automatic
R	Automatic reset on right	Three-positions right automatic
B	Automatic reset on left and right	Three-positions left or right automatic

#### (6) Degree of Protection

Code	Protection
A	Conforming to IP66, NEMA13

#### (7) Contacts and Terminals Specifications

Code	Specification
G	General/Screw Terminal Block
P	General/Push-In Plus Terminal Block

#### (8) Contact Configuration

Code	Contact Blocks		Unit position			Two positions	Three positions
	NO	NC	1	2	3		
100	1	0	NO	---	---	Yes	---
002	0	1	---	---	NC	Yes	---
101	2	0	NO	---	NO	Yes	Yes
102	1	1	NO	---	NC	Yes	Yes
201	1	1	NC	---	NO	---	Yes
202	0	2	NC	---	NC	Yes	Yes
110	2	0	NO	NO	---	---	Yes
111	3	0	NO	NO	NO	Yes	Yes
112	2	1	NO	NO	NC	Yes	Yes
210	1	1	NC	NO	---	---	Yes
211	2	1	NC	NO	NO	---	Yes
212	1	2	NC	NO	NC	---	Yes
011	2	0	---	NO	NO	---	Yes
012	1	1	---	NO	NC	---	Yes
120	1	1	NO	NC	---	---	Yes
121	2	1	NO	NC	NO	---	Yes
122	1	2	NO	NC	NC	Yes	Yes
220	0	2	NC	NC	---	---	Yes
221	1	2	NC	NC	NO	---	Yes
222	0	3	NC	NC	NC	Yes	Yes
021	1	1	---	NC	NO	---	Yes
022	0	2	---	NC	NC	---	Yes

**Note:** 1. NO (blue): Normally open, NC (orange): Normally closed.  
2. Refer to the following figure for Unit positions.

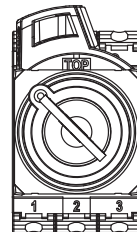

#### Operation Angle

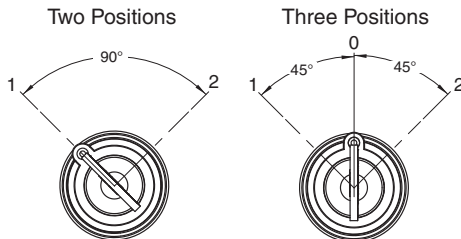

- Specifications: Refer to page 13.
- Dimensions: Refer to page 45.

- Characteristics: Refer to page 44.
- Precautions for correct use: Refer to pages 88 to 99.

Structure

Contact Configuration Table

Two Positions

No. of outputs	Code	Contact configuration	Unit position	Contacts	Position	
					1	2
1	100	SPST-NO	1	NO		ON
			2	---	---	---
			3	---	---	---
1	002	SPST-NC	1	---	---	---
			2	---	---	---
			3	NC	ON	
2	102	SPST-NO/ SPST-NC	1	NO		ON
			2	---	---	---
			3	NC	ON	
2	101	DPST-NO	1	NO		ON
			2	---	---	---
			3	NO		ON
2	202	DPST-NC	1	NC	ON	
			2	---	---	---
			3	NC	ON	
3	111	3PST-NO	1	NO		ON
			2	NO		ON
			3	NO		ON
3	222	3PST-NC	1	NC	ON	
			2	NC	ON	
			3	NC	ON	
3	122	SPST-NO/ DPST-NC	1	NO		ON
			2	NC	ON	
			3	NC	ON	
3	112	DPST-NO/ SPST-NC	1	NO		ON
			2	NO		ON
			3	NC	ON	

Three Positions

No. of outputs	Code	Contact configuration	Unit position	Contacts	Position		
					1	0	2
2	110	DPST-NO	1	NO	ON		
			2	NO	ON		ON
			3	---	---	---	---
2	011	DPST-NO	1	---	---	---	---
			2	NO	ON		ON
			3	NO			ON
2	101	DPST-NO	1	NO	ON		
			2	---	---	---	---
			3	NO			ON
2	220	DPST-NC	1	NC		ON	ON
			2	NC		ON	
			3	---	---	---	---
2	022	DPST-NC	1	---	---	---	---
			2	NC		ON	
			3	NC	ON	ON	

Operation Angle

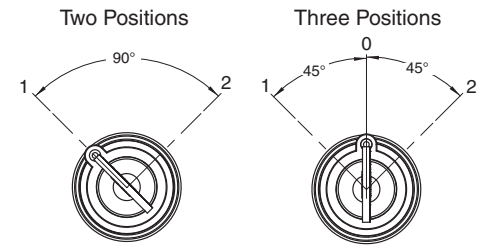

Pushbutton Switches  
A22N

Selector Switches  
A22N

Key-type Selector Switches  
A22N

Indicators  
M22N

Pushbutton Switches  
A30N

Selector Switches  
A30N

Key-type Selector Switches  
A30N

Subassemblies  
(Common)

Accessories  
and Tools

Safety  
Precautions

# A22NK

## Operation Angle

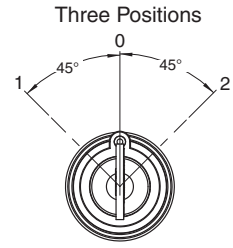



No. of outputs	Code	Contact configuration	Unit position	Contacts	Position		
					1	0	2
2	202	DPST-NC	1	NC		ON	ON
			2	---	---	---	---
			3	NC	ON	ON	
2	120	SPST-NO/ SPST-NC	1	NO	ON		
			2	NC		ON	
			3	---	---	---	---
2	102	SPST-NO/ SPST-NC	1	NO	ON		
			2	---	---	---	---
			3	NC	ON	ON	
2	210	SPST-NO/ SPST-NC	1	NC		ON	ON
			2	NO	ON		ON
			3	---	---	---	---
2	201	SPST-NO/ SPST-NC	1	NC		ON	ON
			2	---	---	---	---
			3	NO			ON
2	012	SPST-NO/ SPST-NC	1	---	---	---	---
			2	NO	ON		ON
			3	NC	ON	ON	
2	021	SPST-NO/ SPST-NC	1	---	---	---	---
			2	NC		ON	
			3	NO			ON
3	111	3PST-NO	1	NO	ON		
			2	NO	ON		ON
			3	NO			ON
3	222	3PST-NC	1	NC		ON	ON
			2	NC		ON	
			3	NC	ON	ON	
3	122	SPST-NO/ DPST-NC	1	NO	ON		
			2	NC		ON	
			3	NC	ON	ON	
3	212	SPST-NO/ DPST-NC	1	NC		ON	ON
			2	NO	ON		ON
			3	NC	ON	ON	
3	221	SPST-NO/ DPST-NC	1	NC		ON	ON
			2	NC		ON	
			3	NO	ON		ON
3	211	DPST-NO/ SPST-NC	1	NC		ON	ON
			2	NO	ON		ON
			3	NO			ON
3	121	DPST-NO/ SPST-NC	1	NO	ON		
			2	NC		ON	
			3	NO			ON
3	112	DPST-NO/ SPST-NC	1	NO	ON		
			2	NO	ON		ON
			3	NC	ON	ON	

■ Specifications: Refer to page 13.      ■ Characteristics: Refer to page 44.  
 ■ Dimensions: Refer to page 45.        ■ Precautions for correct use: Refer to pages 88 to 99.

# Ordering Information

**Model Numbers for Sets** - - - Shipped as a set that includes the Operation Unit, Mounting Collar, and Contact Block.  
**Two-position, Key-type Selector Switches**

Appearance	Bezel material	No. of outputs	Model	(3) Reset method	(5) Key release positions	(8)(8)(8) Contact configuration	
Plastic bezels 	2B	1	A22NK-2B(3)-01(5)A-G(8)(8)(8)	M: Manual L: Automatic reset on left	A: All positions B: Left C: Right	100 002	
			A22NK-2B(3)-01(5)A-P(8)(8)(8)			102 101 202	
		2	A22NK-2B(3)-01(5)A-G(8)(8)(8)			111 222 122 112	
			A22NK-2B(3)-01(5)A-P(8)(8)(8)				
		3	A22NK-2B(3)-01(5)A-G(8)(8)(8)				
			A22NK-2B(3)-01(5)A-P(8)(8)(8)				
Brushed metal bezels 	2M	1	A22NK-2M(3)-01(5)A-G(8)(8)(8)				100 002
			A22NK-2M(3)-01(5)A-P(8)(8)(8)			102 101 202	
		2	A22NK-2M(3)-01(5)A-G(8)(8)(8)			111 222 122 112	
			A22NK-2M(3)-01(5)A-P(8)(8)(8)				
		3	A22NK-2M(3)-01(5)A-G(8)(8)(8)				
			A22NK-2M(3)-01(5)A-P(8)(8)(8)				
Metal bezels 	2R	1	A22NK-2R(3)-01(5)A-G(8)(8)(8)		100 002		
			A22NK-2R(3)-01(5)A-P(8)(8)(8)	102 101 202			
		2	A22NK-2R(3)-01(5)A-G(8)(8)(8)	111 222 122 112			
			A22NK-2R(3)-01(5)A-P(8)(8)(8)				
		3	A22NK-2R(3)-01(5)A-G(8)(8)(8)				
			A22NK-2R(3)-01(5)A-P(8)(8)(8)				

Pushbutton Switches  
A22N

Selector Switches  
A22N

Key-type Selector Switches  
A22N

Indicators  
M22N

Pushbutton Switches  
A30N

Selector Switches  
A30N

Key-type Selector Switches  
A30N

Subassemblies  
(Common)

Accessories  
and Tools

Safety  
Precautions

# A22NK

## Three-position, Key-type Selector Switches

Appearance	Bezel material	No. of outputs	Model	(3) Reset method	(5) Key release positions	(8)(8)(8) Contact configuration
Plastic bezels 	3B	2	A22NK-3B(3)-01(5)A-G(8)(8)(8)	M: Manual L: Automatic reset on left R: Automatic reset on right B: Automatic reset on left and right	A: All positions B: Left C: Right D: Center G: Left and right	110
			011			
		3	A22NK-3B(3)-01(5)A-P(8)(8)(8)			101
			A22NK-3B(3)-01(5)A-G(8)(8)(8)			220
			A22NK-3B(3)-01(5)A-P(8)(8)(8)			022
			A22NK-3B(3)-01(5)A-P(8)(8)(8)			202
Brushed metal bezels 	3M	2	A22NK-3M(3)-01(5)A-G(8)(8)(8)	M: Manual L: Automatic reset on left R: Automatic reset on right B: Automatic reset on left and right	A: All positions B: Left C: Right D: Center G: Left and right	120
			102			
		3	A22NK-3M(3)-01(5)A-P(8)(8)(8)			210
			A22NK-3M(3)-01(5)A-G(8)(8)(8)			201
			A22NK-3M(3)-01(5)A-P(8)(8)(8)			012
			A22NK-3M(3)-01(5)A-P(8)(8)(8)			021
Metal bezels 	3R	2	A22NK-3R(3)-01(5)A-G(8)(8)(8)	M: Manual L: Automatic reset on left R: Automatic reset on right B: Automatic reset on left and right	A: All positions B: Left C: Right D: Center G: Left and right	111
			011			
		3	A22NK-3R(3)-01(5)A-P(8)(8)(8)			101
			A22NK-3R(3)-01(5)A-G(8)(8)(8)			220
			A22NK-3R(3)-01(5)A-P(8)(8)(8)			022
			A22NK-3R(3)-01(5)A-P(8)(8)(8)			202
Subassemblies (Common)		2	A22NK-3R(3)-01(5)A-G(8)(8)(8)	M: Manual L: Automatic reset on left R: Automatic reset on right B: Automatic reset on left and right	A: All positions B: Left C: Right D: Center G: Left and right	120
			102			
		3	A22NK-3R(3)-01(5)A-P(8)(8)(8)			210
			A22NK-3R(3)-01(5)A-G(8)(8)(8)			201
			A22NK-3R(3)-01(5)A-P(8)(8)(8)			012
			A22NK-3R(3)-01(5)A-P(8)(8)(8)			021

■ Subassemblies: Refer to pages 41 to 42 and 82.  
 (You can order Operation Units, Mounting Collars, and Contact Blocks individually.)

■ Specifications: Refer to page 13 ■ Characteristics: Refer to page 44.  
 ■ Dimensions: Refer to page 45.  
 ■ Accessories and tools: Refer to pages 84 to 85.



# Ordering Information

**Subassemblies** - - - - You can order Operation Units, Mounting Collars, and Contact Blocks individually. Use them in combination for models that are not available as assembled Switches. They can also be used as inventory for maintenance parts.

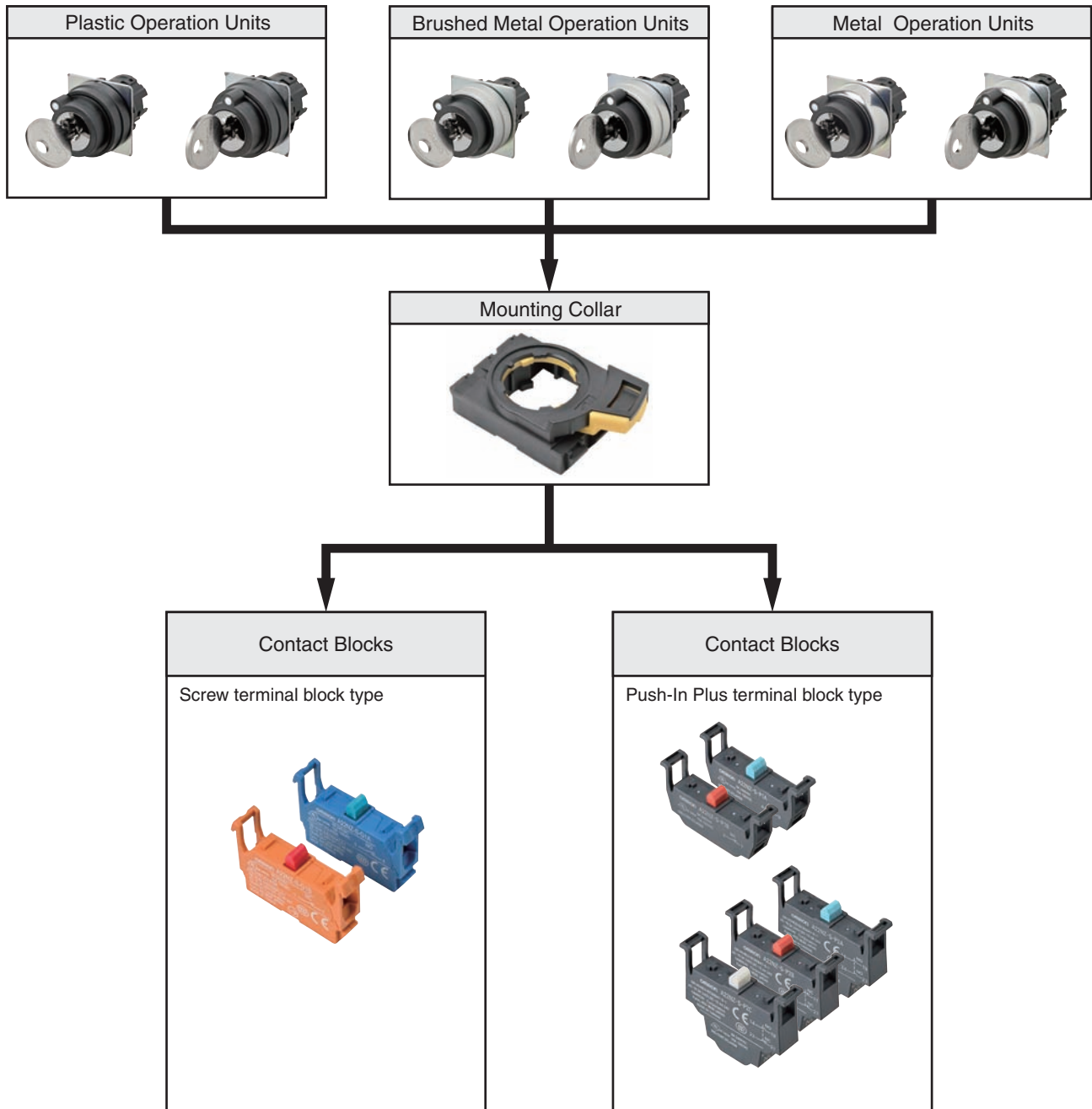

- Model numbers of sets: Refer to pages 39 to 40.
- Specifications: Refer to page 13.
- Characteristics: Refer to page 44.

- Dimensions: Refer to page 45.
- Subassemblies (Common): Refer to page 82.
- Accessories and tools: Refer to pages 84 to 85.

Pushbutton Switches  
A22N

Selector Switches  
A22N

Key-type Selector Switches  
A22N

Indicators  
M22N

Pushbutton Switches  
A30N

Selector Switches  
A30N

Key-type Selector Switches  
A30N

Subassemblies (Common)

Accessories and Tools



Safety Precautions

# A22NK

## Ordering Information

**Subassemblies** - - - - You can order Operation Units, Mounting Collars, and Contact Blocks individually. Use them in combination for models that are not available as assembled Switches. They can also be used as inventory for maintenance parts.

### Operation Units

Bezel material and shape		Plastic	Brushed metal	Metal	(1) Key release positions
					
No. of positions	Reset method	Model	Model	Model	
	2	Manual	A22NZ-2BM-01(1)A	A22NZ-2MM-01(1)A	
Automatic reset on left		A22NZ-2BL-01(1)A	A22NZ-2ML-01(1)A	A22NZ-2RL-01(1)A	
3	Manual	A22NZ-3BM-01(1)A	A22NZ-3MM-01(1)A	A22NZ-3RM-01(1)A	A: All positions B: Left C: Right D: Center G: Left and right
	Automatic reset on left	A22NZ-3BL-01(1)A	A22NZ-3ML-01(1)A	A22NZ-3RL-01(1)A	
	Automatic reset on right	A22NZ-3BR-01(1)A	A22NZ-3MR-01(1)A	A22NZ-3RR-01(1)A	
	Automatic reset on left and right	A22NZ-3BB-01(1)A	A22NZ-3MB-01(1)A	A22NZ-3RB-01(1)A	

■ Model numbers of sets: Refer to pages 39 to 40.  
 ■ Specifications: Refer to page 13.  
 ■ Characteristics: Refer to page 44.

■ Dimensions: Refer to page 45.  
 ■ Subassemblies (Common): Refer to page 82.  
 ■ Accessories and tools: Refer to pages 84 to 85.

Pushbutton Switches  
A22N

Selector Switches  
A22N

Key-type Selector Switches  
A22N

Indicators  
M22N

Pushbutton Switches  
A30N

Selector Switches  
A30N

Key-type Selector Switches  
A30N

Subassemblies  
(Common)

Accessories  
and Tools

Safety  
Precautions

## Specifications

### Certified Safety Standard Ratings

UL 508 (File No. E76675), CSA C22.2 No.14

6 A 240 VAC, 10 A 120 VAC

TÜV (EN60947-5-1)

AC-15 3 A 240 VAC

DC-13 4 A 24 VDC

CCC (GB14048.5)

AC-15 3 A 240 VAC

DC-13 4 A 24 VDC

### Application Standards

UL1059 and UL486E (Push-In Plus terminal block type)

### Ratings

#### Contacts (Standard Load)

Rated insulation voltage		600 V				
Rated carry current		10 A				
Rated voltage		24 V	120 V	240 V	380 V	440 V
AC at 50/60 Hz	Resistive load (AC-12)	10 A	10 A	6 A	2A	2 A
	Inductive load (AC-15)	10 A	6 A	3 A	1.9 A	1.6 A
DC	Resistive load (DC-12)	8 A	2.2 A	1.1 A	---	---
	Inductive load (DC-13)	4 A	1.1 A	0.55 A	---	---

**Note:** 1. The above ratings were obtained by conducting tests under the following conditions.

(1) Ambient temperature: 20 ±2°C

(2) Ambient humidity: 65% ±5% RH

(3) Operating frequency: 30 operations/minute

2. Minimum applicable load: 10 mA at 5 VDC.

Pushbutton Switches  
A22NSelector Switches  
A22NKey-type Selector Switches  
A22NIndicators  
M22NPushbutton Switches  
A30NSelector Switches  
A30NKey-type Selector Switches  
A30NSubassemblies  
(Common)Accessories  
and ToolsSafety  
Precautions

# A22NK

## Specifications

### Characteristics

Item	Type	Key-type Selector Switches	
		Manual reset	Automatic reset
Allowable operating frequency	Mechanical	30 operations/minute max.	
	Electrical	30 operations/minute max.	
Insulation resistance		100 MΩ min. (at 500 VDC)	
Contact resistance		100 mΩ max. (initial value)	
Dielectric strength	Between terminals of same polarity	2,500 VAC at 50/60 Hz for 1 min. (initial value)	
	Between each terminal and ground	2,500 VAC at 50/60 Hz for 1 min. (initial value)	
Vibration resistance	Malfunction	10 to 55 Hz, 1.5-mm double amplitude (malfunction within 1 ms)	
Shock resistance	Malfunction	1,000 m/s <sup>2</sup> max. (malfunction within 1 ms)	
Durability	Mechanical	500,000 operations min. (Switches with 3 positions: 300,000 operations min.)	
	Electrical	500,000 operations min. (Switches with 3 positions: 300,000 operations min.) (250 VAC, 3 A, with an inductive load having power factor cos θ = 0.4)	
Ambient operating temperature <sup>*1</sup>		-25 to 70°C	
Ambient operating humidity		35% to 85% RH	
Ambient storage temperature <sup>*1</sup>		-40 to 80°C	
Degree of protection <sup>*2</sup>		Conforming to IP66, NEMA13	
Electric shock protection class		Class II	
PTI (tracking characteristic)		175	
Degree of contamination (application environment)		3 (EN 60947-5-1)	
Weight		Approx. 65 g (for 1NC/1NO)	

\*1. With no icing or condensation.

\*2. Degree of protection from the front of the panel.

### Operating Characteristics (for SPST-NO/SPST-NC)

Item	Type	Key-type Selector Switches	
		Manual reset	Automatic reset
Total travel force (torque) (maximum TTF)		0.6 N·m	0.6 N·m
Total travel (TT)		2 positions: Approx. 90°, 3 positions: Approx. 45°	
Resetting force (torque) (RF)		0.5 N·m max.	---

### Examples of Linked Contact Blocks

#### (Screw terminal block type)

 Contact Blocks

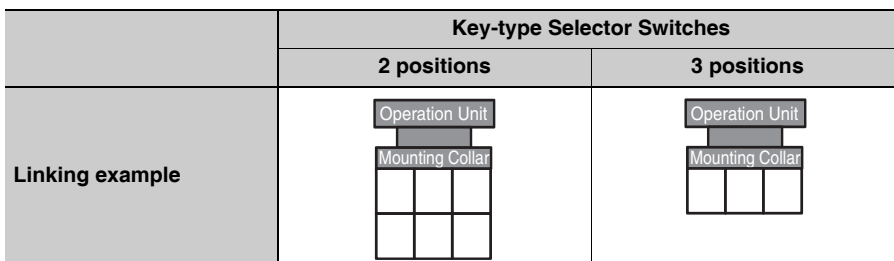

**Note:** If you increase the number of Contact Blocks, evaluate the Switch under actual working conditions before permanent installation and use the Switch within a number of switching operations that will not adversely affect the Switch's performance.

# Dimensions

(Unit: mm)

## Lighted and Non-lighted Key-type Selection Switches

### Two-position Switches with Plastic Bezels

A22NK-2B□-01□A-G

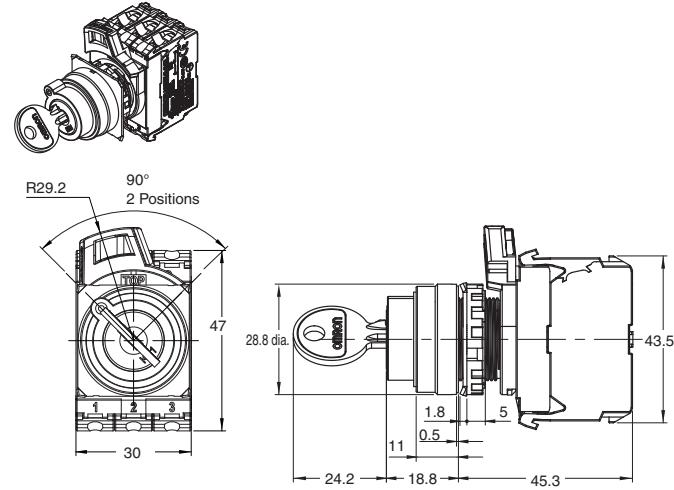

A22NK-2B□-01□A-P

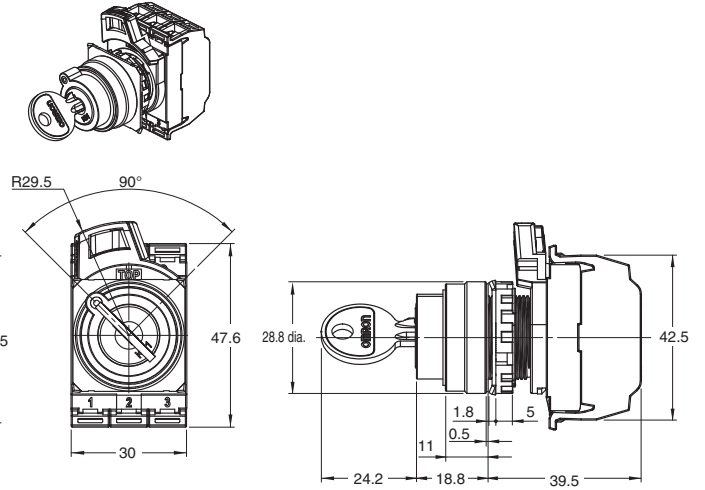

### Three-position Switches with Plastic Bezels

A22NK-3B□-01□A-G

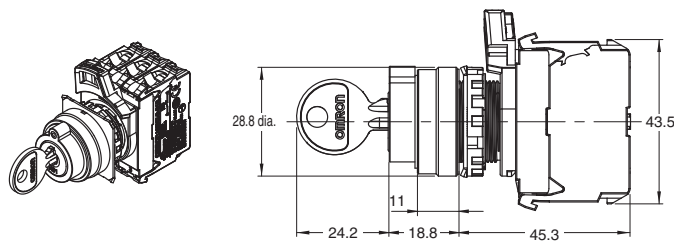

A22NK-3B□-01□A-P

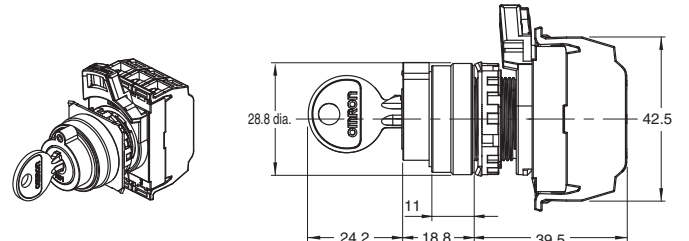

### Two-position Switches with Brushed Metal Bezels

A22NK-2M□-01□A-G

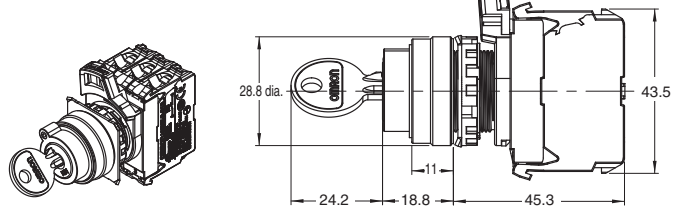

A22NK-2M□-01□A-P

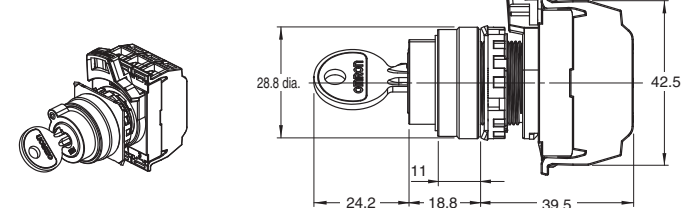

### Three-position Switches with Brushed Metal Bezels

A22NK-3M□-01□A-G

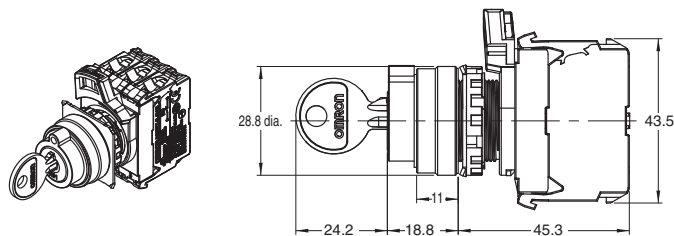

A22NK-3M□-01□A-P

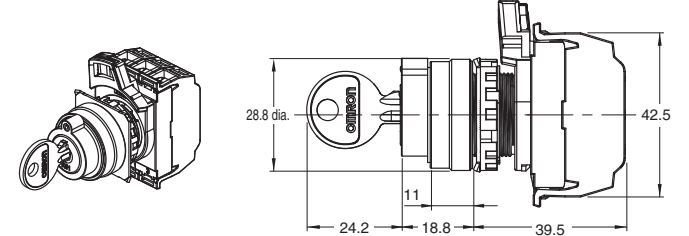

# A22NK

## Two-position Switches with Metal Bezels

A22NK-2R□-01□A-G

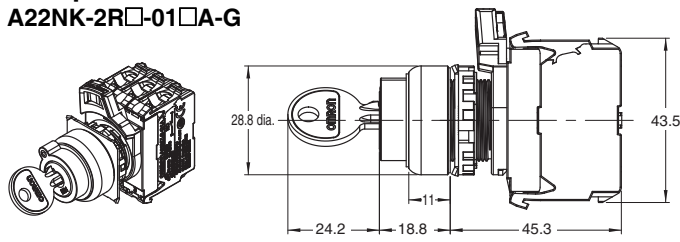

A22NK-2R□-01□A-P

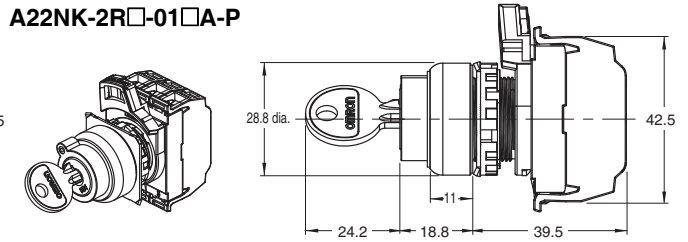

## Three-position Switches with Metal Bezels

A22NK-3R□-01□A-G

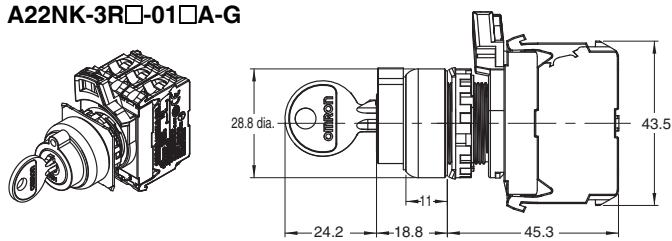

A22NK-3R□-01□A-P

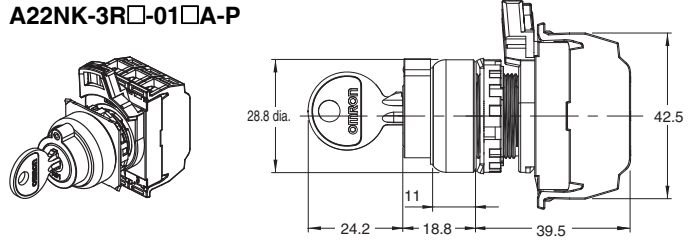

## Depth with Linked Units (Screw terminal block type)

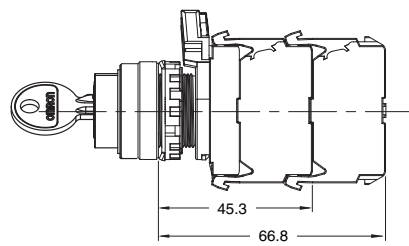

## Depth when a double-contact unit is mounted (Push-In Plus terminal block type)

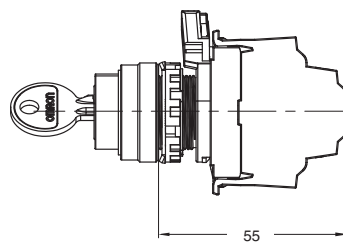

## Terminal Arrangement

**BOTTOM VIEW**  
(Screw terminal block type)

**2NO/1NC**  
Contact configuration code:112

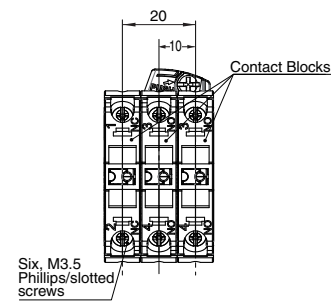

**BOTTOM VIEW**  
(Push-in Plus terminal block type)

**2NO/1NC**  
Contact configuration code:112

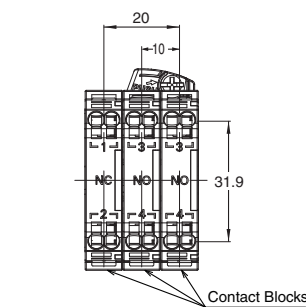

**Double-contact unit**  
(2NO/2NO/2NC)

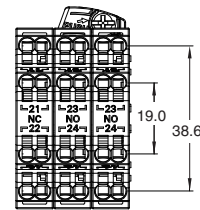

## Terminal Connection Diagrams

**2NO/1NC**  
Contact configuration code:112

Bottom View

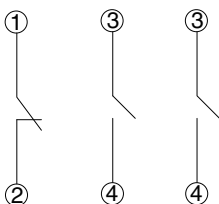

**Note:** The above shows a terminal connection diagram for a screw terminal block type.

# Indicators M22N

**22-mm dia. Indicators**  
**Control panel miniaturization through a more compact design and modified wiring direction.**  
**Addition of Push-In Plus terminal blocks for easy wiring.**



**Easy to Use**

- Improved wiring visibility through to a modified wiring direction. (Push-In Plus terminal block type)
- Screw terminal structure is compatible with round crimp terminals. (Screw terminal block type)

**Miniaturization**

- No need for extra lateral space because of the modified wiring direction. (Push-In Plus terminal block type)
- Compact design.

**Product Lineup**

- Meet global safety standards.
- Can be installed in two types of panel hole dimensions: 22.3 and 25.5 dia.
- The indicators come in a wide variety of colors and shapes.
- Standard-feature degree of protection: IP66, NEMA 4X, and NEMA 13.

 Refer to *Safety Precautions for All Pushbutton Switches/Indicators and Safety Precautions* on page 88.

## Indicator Unit Colors

	Red	Green	Yellow	White	Blue	Orange	White
When not lit							
When lit	Red	Green	Yellow	White	Blue	Orange	Opaque white*

\* The colors when the Switches are lit are for transparent white Indicator Units (code: TW) and yellow LED Lamps (code: Y).

# M22N

## List of Models

Screw Terminal Blocks/Push-In Plus Terminal Blocks	
Appearance	Model
Plastic flat 	M22N-BN
Plastic projected 	M22N-BP
Plastic semi-spherical 	M22N-BG
Plastic flat etched 	M22N-BC

Pushbutton Switches  
A22N

Selector Switches  
A22N

Key-type Selector Switches  
A22N

Indicators  
M22N

Pushbutton Switches  
A30N

Selector Switches  
A30N

Key-type Selector Switches  
A30N

Subassemblies  
(Common)

Accessories  
and Tools

Safety  
Precautions



## Model Number Structure

**Model Number Legend** - -Shipped as a set that includes the Indicator Unit, LED Lamp, and Socket Unit.  
For information on combinations, refer to *Ordering Information* on page 50.

### Model Numbers for Sets

M 2 2 N - <sup>(1)</sup>BN - <sup>(2)</sup>TR <sup>(3)</sup>A - <sup>(4)</sup>R <sup>(5)</sup>A - <sup>(6)</sup>

#### (1) Indicator Unit Shape

Code	Shape
BN	Plastic flat
BP	Plastic projected
BG	Plastic semi-spherical
BC	Plastic flat etched

#### (2) Indicator Color and (4) LED Lamp Color

Code (2)	Code (4)	Indicator color	LED Lamp color
TR	R	Red	Red
TG	G	Green	Green
TY	Y	Yellow	Yellow
TW	W	White	White
TA	A	Blue	Blue
TO	O	Orange	Orange
TW	Y	White*	Yellow

\* The color is opaque white when the Indicator is lit.

#### (3) Degree of Protection

Code	Protection
A	Conforming to IP66, NEMA 4X, NEMA13

#### (5) LED Lamp Voltage

Code	LED Lamp voltage
A	6 VAC/DC
B	12 VAC/DC
C	24 VAC/DC
D	100/110/120 VAC
E	200/220/230/240 VAC

#### (6) Terminals Specifications

Code	Specification
No Code	Screw Terminal Block
P	Push-In Plus Terminal Block

■ Specifications: Refer to page 51.

■ Accessories and tools: Refer to pages 84 to 85.

■ Dimensions: Refer to page 52.





■ Precautions for correct use: Refer to pages 88 to 99.

# M22N

## Ordering Information

**Model Numbers for Sets** - - - - Shipped as a set that includes the Indicator Unit, LED Lamp, and Socket Unit.

### Indicators

Appearance	Rated voltage	Model	(2)(2) Indicator color	(4) LED lamp color
Plastic flat 	6 VAC/DC	M22N-BN-(2)(2)A-(4)A	TR: Transparent red TG: Transparent green TY: Transparent yellow TW: Transparent white TA: Transparent blue TO: Transparent orange	
		M22N-BN-(2)(2)A-(4)A-P		
	12 VAC/DC	M22N-BN-(2)(2)A-(4)B		
		M22N-BN-(2)(2)A-(4)B-P		
	24 VAC/DC	M22N-BN-(2)(2)A-(4)C		
		M22N-BN-(2)(2)A-(4)C-P		
	100, 110, or 120 VAC	M22N-BN-(2)(2)A-(4)D		
		M22N-BN-(2)(2)A-(4)D-P		
	200, 220, 230, or 240 VAC	M22N-BN-(2)(2)A-(4)E		
		M22N-BN-(2)(2)A-(4)E-P		
Plastic projected 	6 VAC/DC	M22N-BP-(2)(2)A-(4)A		
		M22N-BP-(2)(2)A-(4)A-P		
	12 VAC/DC	M22N-BP-(2)(2)A-(4)B		
		M22N-BP-(2)(2)A-(4)B-P		
	24 VAC/DC	M22N-BP-(2)(2)A-(4)C		
		M22N-BP-(2)(2)A-(4)C-P		
	100, 110, or 120 VAC	M22N-BP-(2)(2)A-(4)D		
		M22N-BP-(2)(2)A-(4)D-P		
	200, 220, 230, or 240 VAC	M22N-BP-(2)(2)A-(4)E		
		M22N-BP-(2)(2)A-(4)E-P		
Plastic semi-spherical 	6 VAC/DC	M22N-BG-(2)(2)A-(4)A		
		M22N-BG-(2)(2)A-(4)A-P		
	12 VAC/DC	M22N-BG-(2)(2)A-(4)B		
		M22N-BG-(2)(2)A-(4)B-P		
	24 VAC/DC	M22N-BG-(2)(2)A-(4)C		
		M22N-BG-(2)(2)A-(4)C-P		
	100, 110, or 120 VAC	M22N-BG-(2)(2)A-(4)D		
		M22N-BG-(2)(2)A-(4)D-P		
	200, 220, 230, or 240 VAC	M22N-BG-(2)(2)A-(4)E		
		M22N-BG-(2)(2)A-(4)E-P		
Plastic flat etched 	6 VAC/DC	M22N-BC-(2)(2)A-(4)A		
		M22N-BC-(2)(2)A-(4)A-P		
	12 VAC/DC	M22N-BC-(2)(2)A-(4)B		
		M22N-BC-(2)(2)A-(4)B-P		
	24 VAC/DC	M22N-BC-(2)(2)A-(4)C		
		M22N-BC-(2)(2)A-(4)C-P		
	100, 110, or 120 VAC	M22N-BC-(2)(2)A-(4)D		
		M22N-BC-(2)(2)A-(4)D-P		
	200, 220, 230, or 240 VAC	M22N-BC-(2)(2)A-(4)E		
		M22N-BC-(2)(2)A-(4)E-P		

**Note:** Normally, the Indicator Unit and LED Lamp with the same color are combined.  
 However, opaque white is available by combining a white Indicator Unit and yellow LED. M22N-B□-TWA-Y□-□

- Specifications: Refer to page 51.
- Dimensions: Refer to page 52.
- Accessories and tools: Refer to pages 84 to 85.
- Precautions for correct use: Refer to pages 88 to 99.

# Ratings and Specifications

## Certified Standard Ratings

### UL508 (File No.E76675), CSA C22.2 No.14

12 mA 6 VAC/DC  
 12 mA 12 VAC/DC  
 12 mA 24 VAC/DC  
 12 mA 100-120 VAC  
 12 mA 200-240 VAC

### TÜV (EN60947-5-1)

80 mA 6 VAC/DC  
 40 mA 12 VAC/DC  
 20 mA 24 VAC/DC  
 10 mA 100-120 VAC  
 5 mA 200-240 VAC

### CCC (GB14048.5)

6, 12, 24 VAC/DC  
 100-120, 200-240 VAC

## Application Standards

UL1059 and UL486E (Push-In Plus terminal block type)

## Ratings

### LED Lamps

Rated voltage	Applied voltage	Current
6 VAC/DC	6 VAC/DC $\pm 10\%$	Approx. 11 mA (red, orange, yellow, or blue) Approx. 5 mA (white or green)
12 VAC/DC	12 VAC/DC $\pm 10\%$	Approx. 12 mA (red, orange, yellow, or blue) Approx. 5 mA (white or green)
24 VAC/DC	24 VAC/DC $\pm 10\%$	Approx. 12 mA (red, orange, yellow, or blue) Approx. 5 mA (white or green)
100 VAC	100 VAC $\pm 10\%$	Approx. 12 mA (red, orange, yellow, or blue) Approx. 5 mA (white or green)
110 VAC	110 VAC $\pm 10\%$	
120 VAC	100-130 VAC	
200 VAC	200 VAC $\pm 10\%$	Approx. 12 mA (red, orange, yellow, or blue) Approx. 5 mA (white or green)
220 VAC	220 VAC $\pm 10\%$	
230 VAC	230 VAC $\pm 10\%$	
240 VAC	220-250 VAC	

## Characteristics

Item	Type	Indicator
Allowable operating frequency	Mechanical	---
	Electrical	---
Insulation resistance		---
Contact resistance		---
Dielectric strength	Between terminals of same polarity	---
	Between each terminal and ground	2,500 VAC at 50/60 Hz for 1 min. (initial value)
Vibration resistance	Malfunction	10 to 55 Hz, 1.5-mm double amplitude
Shock resistance	Malfunction	1,000 m/s <sup>2</sup> max.
Durability	Mechanical	---
	Electrical	---
Ambient operating temperature <sup>*1</sup>		-25 to 55°C
Ambient operating humidity		35% to 85% RH
Ambient storage temperature <sup>*1</sup>		-40 to 80°C
Degree of protection <sup>*2</sup>		Conforming to IP66, NEMA 4X, NEMA13
Electric shock protection class		Class II
PTI (tracking characteristic)		175
Degree of contamination (application environment)		3 (EN 60947-5-1)
Weight		Approx. 30 g

\*1. With no icing or condensation.

\*2. Degree of protection from the front of the panel.

# M22N

## Dimensions

(Unit: mm)

### Indicators

#### Plastic Flat Indicators

M22N-BN-□□A-□□

M22N-BN-□□A-□□-P

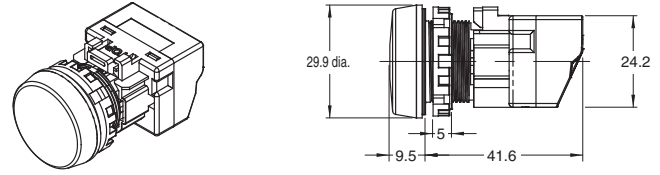
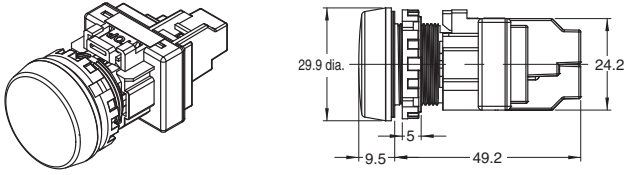

#### Plastic Semi-spherical Indicators

M22N-BG-□□A-□□

M22N-BG-□□A-□□-P

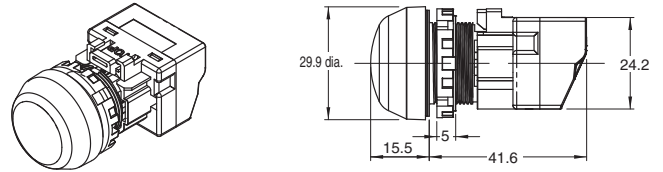
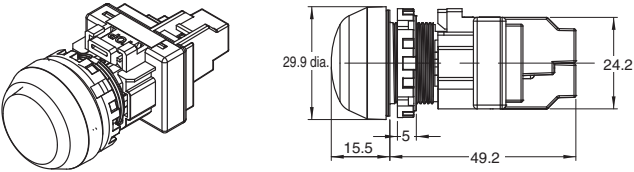

#### Plastic Projected Indicators

M22N-BP-□□A-□□

M22N-BP-□□A-□□-P

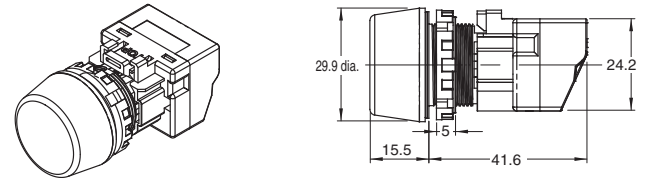
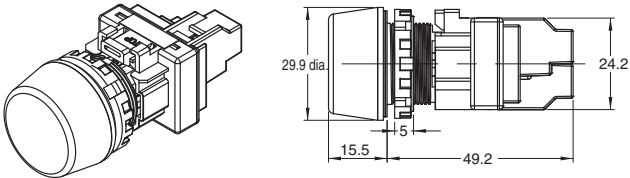

#### Plastic Flat Etched Indicators

M22N-BC-□□A-□□

M22N-BC-□□A-□□-P

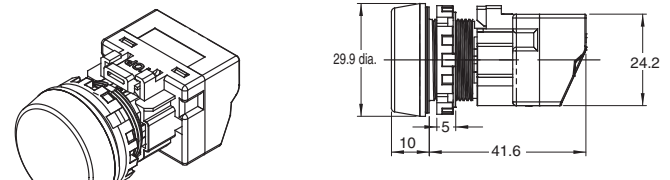
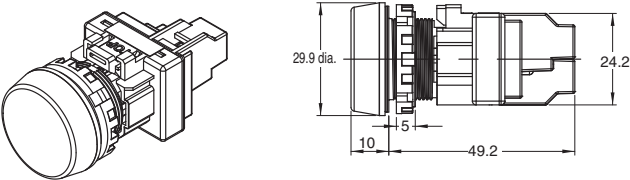

Pushbutton Switches  
A22N

Selector Switches  
A22N

Key-Type Selector Switches  
A22N

Indicators  
M22N

Pushbutton Switches  
A30N

Selector Switches  
A30N

Key-Type Selector Switches  
A30N

Subassemblies  
(Common)

Accessories  
and Tools

Safety  
Precautions

# Pushbutton Switches A30NN/A30NL

**30-mm dia. Pushbutton Switches**  
**Control panel miniaturization through a more compact design and modified wiring direction.**  
**Addition of Push-In Plus terminal blocks for easy wiring.**  
**Workability and safety improvements.**



### Easy to Use

- You can connect up to three Contact Blocks in one stage for multistage expansion. (Screw terminal block type)
- Screw terminal structure is compatible with round crimp terminals. (Screw terminal block type)
- The terminals can be secured even when a contact block is mounted. (Screw terminal block type)
- Contact Blocks can be attached in any direction for easy assembly.

### Safety

- Easy-to-operate lock lever for secure locking.
- Easy-mounting Contact Blocks provide finger protection.
- No loose connections of wiring means maintenance-free use. (Push-In Plus terminal block type)

### Product Lineup

- The buttons and bezels come in a wide variety of colors and shapes.

Refer to *Safety Precautions for All Pushbutton Switches/Indicators and Safety Precautions* on page 88.

## Button Colors

Non-lighted Switches	A30NN-□□□-N□ Opaque		Red	Green	Yellow	White	Blue	Black	
	A30NN-□□□-U□ Transparent		Red	Green	Yellow	White	Blue	Orange	
Lighted Switches	A30NL-□□□-T□ Transparent	When not lit	Red	Green	Yellow	White	Blue	Orange	White
			Red	Green	Yellow	White	Blue	Orange	Opaque white*
		When lit	Red	Green	Yellow	White	Blue	Orange	Opaque white*
			Red	Green	Yellow	White	Blue	Orange	Opaque white*

\* The colors when the Switches are lit are for transparent white buttons (code: TW) and yellow LED Lamps (code: Y).

Pushbutton Switches  
A22N

Selector Switches  
A22N

Key-type Selector Switches  
A22N

Indicators  
M22N

Pushbutton Switches  
A30N

Selector Switches  
A30N

Key-type Selector Switches  
A30N

Subassemblies (Common)

Accessories and Tools

Safety Precautions

# A30NN/A30NL

## List of Models

### Screw Terminal Blocks/Push-In Plus Terminal Blocks

Brushed metal bezels

A30N□-MN

Flat



A30N□-MP

Projected

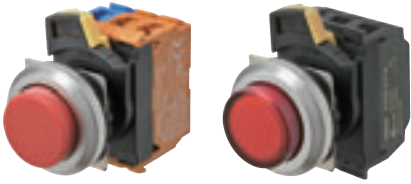

A30N□-MG

Full guard



A30N□-MM

Mushroom



Pushbutton Switches  
A22N

Selector Switches  
A22N

Key-Type Selector Switches  
A22N

Indicators  
M22N

Pushbutton Switches  
A30N

Selector Switches  
A30N

Key-Type Selector Switches  
A30N

Subassemblies  
(Common)

Accessories  
and Tools

Safety  
Precautions

# Model Number Structure

**Model Number Legend** - - - - Please order Operation Units, LED lamps (lighted models only), Mounting Collars, Contact Blocks, and Lighting Units (lighted models only) separately. LED lamps, Mounting Collars, Contact Blocks, and Lighting Units can also be used with the A22N series.

## Model Numbers for Sets

A 30N <sup>(1)</sup> L - <sup>(2)</sup> MN <sup>(3)</sup> M - <sup>(4)</sup> TR <sup>(5)</sup> A - <sup>(6)</sup> G <sup>(7)</sup> 100 - <sup>(8)</sup> R <sup>(9)</sup> B

### (1) Type

Code	Description
N	Non-lighted
L	Lighted

### (2) Bezel Material and Button Shape

Code	Bezel material	Button shape
MN	Brushed metal	Flat
MP	Brushed metal	Projected
MG	Brushed metal	Full guard
MM	Brushed metal	Mushroom

### (3) Switch Action

Code	Function
M	Momentary Action: Self-Resetting
A	Alternate Action: Self-Holding

### (4) Button Transparency and Color and (8) LED Lamp Color

Lighted/non-lighted	Code (4)	Code (8)	Transparency	Button color	LED lamp color	
Non-lighted	NR	N	Opaque	Red	---	
	NG	N	Opaque	Green		
	NY	N	Opaque	Yellow		
	NW	N	Opaque	White		
	NA	N	Opaque	Blue		
	NB	N	Opaque	Black		
	UR	N	Transparent	Red		
	UG	N	Transparent	Green		
	UY	N	Transparent	Yellow		
	UW	N	Transparent	White		
Lighted	UA	N	Transparent	Blue	---	
	UO	N	Transparent	Orange		
	TR	R	Transparent	Red		Red
	TG	G	Transparent	Green		Green
	TY	Y	Transparent	Yellow		Yellow
	TW	W	Transparent	White		White
	TA	A	Transparent	Blue		Blue
TO	O	Transparent	Orange	Orange		
TW	Y	Transparent	White *	Yellow		

\* The color is opaque white when the Switch is lit.

### (5) Degree of Protection

Code	Description
A	Conforming to IP66, NEMA 4X, NEMA13

### (6) Contacts and Terminals Specifications

Code	Specification
G	General/Screw Terminal Block
P	General/Push-In Plus Terminal Block

### (7) Contacts

Code	Contact Blocks		Unit position					
			Non-lighted			Lighted		
	NO	NC	1	2	3	1	2	3
100	1	0	NO	---	---	NO	Lighting Unit	---
002	0	1	---	---	NC	---	Lighting Unit	NC
101	2	0	NO	---	NO	NO	Lighting Unit	NO
102	1	1	NO	---	NC	NO	Lighting Unit	NC
202	0	2	NC	---	NC	NC	Lighting Unit	NC
111	3	0	NO	NO	NO			
112	2	1	NO	NO	NC			
122	1	2	NO	NC	NC			
222	0	3	NC	NC	NC			

**Note:** 1. NO (blue): Normally open, NC (orange): Normally closed.  
 2. Refer to the following figure for Unit positions.

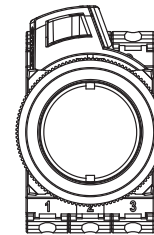

### (9) LED Lamp Voltage

Code	LED Lamp voltage
N	Non-lighted
A	6 VAC/DC
B	12 VAC/DC
C	24 VAC/DC
D	100/110/120 VAC
E	200/220/230/240 VAC

- Specifications: Refer to page 60.
- Subassemblies (Common): Refer to page 82.
- Precautions for correct use: Refer to pages 88 to 99.

- Dimensions: Refer to page 62.
- Accessories and tools: Refer to pages 84 to 85.

Pushbutton Switches A22N  
 Selector Switches A22N  
 Key-type Selector Switches A22N  
 Indicators M22N  
 Pushbutton Switches A30N  
 Selector Switches A30N  
 Key-type Selector Switches A30N  
 Subassemblies (Common)  
 Accessories and Tools  
 Safety Precautions

# A30NN/A30NL

## Ordering Information

**Model Numbers for Sets** - - - Shipped as a set that includes the Operation Unit, LED Lamp (lighted models only), Mounting Collar, Contact Block, and Lighting Unit (lighted models only).

### Non-lighted, Flat Switches

Appearance	Contacts	Momentary action (self-resetting)	Alternate action (self-holding)	(4)(4) Button color	(7)(7)(7) Contacts
		Model	Model		
 Brushed metal bezels	1	A30NN-MNM-(4)(4)A-G(7)(7)(7)-NN	A30NN-MNA-(4)(4)A-G(7)(7)(7)-NN	<b>NR:</b> Opaque, red <b>NG:</b> Opaque, green <b>NY:</b> Opaque, yellow <b>NW:</b> Opaque, white <b>NA:</b> Opaque, blue <b>NB:</b> Opaque, black <b>UR:</b> Transparent, red <b>UG:</b> Transparent, green <b>UY:</b> Transparent, yellow <b>UW:</b> Transparent, white <b>UA:</b> Transparent, blue <b>UO:</b> Transparent, orange	100 002
		A30NN-MNM-(4)(4)A-P(7)(7)(7)-NN	A30NN-MNA-(4)(4)A-P(7)(7)(7)-NN		
	2	A30NN-MNM-(4)(4)A-G(7)(7)(7)-NN	A30NN-MNA-(4)(4)A-G(7)(7)(7)-NN		101 102 202
		A30NN-MNM-(4)(4)A-P(7)(7)(7)-NN	A30NN-MNA-(4)(4)A-P(7)(7)(7)-NN		
	3	A30NN-MNM-(4)(4)A-G(7)(7)(7)-NN	A30NN-MNA-(4)(4)A-G(7)(7)(7)-NN		111 112 122 222
		A30NN-MNM-(4)(4)A-P(7)(7)(7)-NN	A30NN-MNA-(4)(4)A-P(7)(7)(7)-NN		

### Lighted, Flat Switches

Appearance	Contacts	Momentary action (self-resetting)	Alternate action (self-holding)	(4)(4) Button color	(7)(7)(7) Contacts	(8) LED Lamp color	(9) LED Lamp voltage
		Model	Model				
 Brushed metal bezels	1	A30NL-MNM-(4)(4)A-G(7)(7)(7)-(8)(9)	A30NL-MNA-(4)(4)A-G(7)(7)(7)-(8)(9)	<b>TR:</b> Transparent, red <b>TG:</b> Transparent, green <b>TY:</b> Transparent, yellow <b>TW:</b> Transparent, white <b>TA:</b> Transparent, blue <b>TO:</b> Transparent, orange	100 002	<b>R:</b> Red <b>G:</b> Green <b>Y:</b> Yellow <b>W:</b> White <b>A:</b> Blue <b>O:</b> Orange	<b>A:</b> 6 VAC/DC <b>B:</b> 12 VAC/DC <b>C:</b> 24 VAC/DC <b>D:</b> 100/110/120 VAC <b>E:</b> 200/220/230/240 VAC
		A30NL-MNM-(4)(4)A-P(7)(7)(7)-(8)(9)	A30NL-MNA-(4)(4)A-P(7)(7)(7)-(8)(9)				
	2	A30NL-MNM-(4)(4)A-G(7)(7)(7)-(8)(9)	A30NL-MNA-(4)(4)A-G(7)(7)(7)-(8)(9)		101 102 202		
		A30NL-MNM-(4)(4)A-P(7)(7)(7)-(8)(9)	A30NL-MNA-(4)(4)A-P(7)(7)(7)-(8)(9)				

### Non-lighted, Projected Switches

Appearance	Contacts	Momentary action (self-resetting)	Alternate action (self-holding)	(4)(4) Button color	(7)(7)(7) Contacts
		Model	Model		
 Brushed metal bezels	1	A30NN-MPM-(4)(4)A-G(7)(7)(7)-NN	A30NN-MPA-(4)(4)A-G(7)(7)(7)-NN	<b>NR:</b> Opaque, red <b>NG:</b> Opaque, green <b>NY:</b> Opaque, yellow <b>NW:</b> Opaque, white <b>NA:</b> Opaque, blue <b>NB:</b> Opaque, black <b>UR:</b> Transparent, red <b>UG:</b> Transparent, green <b>UY:</b> Transparent, yellow <b>UW:</b> Transparent, white <b>UA:</b> Transparent, blue <b>UO:</b> Transparent, orange	100 002
		A30NN-MPM-(4)(4)A-P(7)(7)(7)-NN	A30NN-MPA-(4)(4)A-P(7)(7)(7)-NN		
	2	A30NN-MPM-(4)(4)A-G(7)(7)(7)-NN	A30NN-MPA-(4)(4)A-G(7)(7)(7)-NN		101 102 202
		A30NN-MPM-(4)(4)A-P(7)(7)(7)-NN	A30NN-MPA-(4)(4)A-P(7)(7)(7)-NN		
	3	A30NN-MPM-(4)(4)A-G(7)(7)(7)-NN	A30NN-MPA-(4)(4)A-G(7)(7)(7)-NN		111 112 122 222
		A30NN-MPM-(4)(4)A-P(7)(7)(7)-NN	A30NN-MPA-(4)(4)A-P(7)(7)(7)-NN		

### Lighted, Projected Switches

Appearance	Contacts	Momentary action (self-resetting)	Alternate action (self-holding)	(4)(4) Button color	(7)(7)(7) Contacts	(8) LED Lamp color	(9) LED Lamp voltage
		Model	Model				
 Brushed metal bezels	1	A30NL-MPM-(4)(4)A-G(7)(7)(7)-(8)(9)	A30NL-MPA-(4)(4)A-G(7)(7)(7)-(8)(9)	<b>TR:</b> Transparent, red <b>TG:</b> Transparent, green <b>TY:</b> Transparent, yellow <b>TW:</b> Transparent, white <b>TA:</b> Transparent, blue <b>TO:</b> Transparent, orange	100 002	<b>R:</b> Red <b>G:</b> Green <b>Y:</b> Yellow <b>W:</b> White <b>A:</b> Blue <b>O:</b> Orange	<b>A:</b> 6 VAC/DC <b>B:</b> 12 VAC/DC <b>C:</b> 24 VAC/DC <b>D:</b> 100/110/120 VAC <b>E:</b> 200/220/230/240 VAC
		A30NL-MPM-(4)(4)A-P(7)(7)(7)-(8)(9)	A30NL-MPA-(4)(4)A-P(7)(7)(7)-(8)(9)				
	2	A30NL-MPM-(4)(4)A-G(7)(7)(7)-(8)(9)	A30NL-MPA-(4)(4)A-G(7)(7)(7)-(8)(9)		101 102 202		
		A30NL-MPM-(4)(4)A-P(7)(7)(7)-(8)(9)	A30NL-MPA-(4)(4)A-P(7)(7)(7)-(8)(9)				

**Note:** Normally, the Button and LED Lamp with the same color are combined. However, opaque white is available by combining a white Button and yellow LED. A30NN□-□□□-TWA-□□□□-Y□

■ Subassemblies: Refer to pages 59 and 82.  
 (You can order Operation Units, LED Lamps, Mounting Collars, and Contact Blocks individually.)

■ Specifications: Refer to page 60. ■ Dimensions: Refer to page 62.  
 ■ Accessories and tools: Refer to pages 84 to 85.



## Ordering Information

**Model Numbers for Sets** - - - Shipped as a set that includes the Operation Unit, LED Lamp (lighted models only), Mounting Collar, Contact Block, and Lighting Unit (lighted models only).

### Non-lighted, Full-guard Switches

Appearance	Contacts	Momentary action (self-resetting)	Alternate action (self-holding)	(4)(4) Button color	(7)(7)(7) Contacts
		Model	Model		
Brushed metal bezels 	1	A30NN-MGM-(4)(4)A-G(7)(7)-NN	A30NN-MGA-(4)(4)A-G(7)(7)-NN	<b>NR:</b> Opaque, red <b>NG:</b> Opaque, green <b>NY:</b> Opaque, yellow <b>NW:</b> Opaque, white <b>NA:</b> Opaque, blue <b>NB:</b> Opaque, black <b>UR:</b> Transparent, red <b>UG:</b> Transparent, green <b>UY:</b> Transparent, yellow <b>UW:</b> Transparent, white <b>UA:</b> Transparent, blue <b>UO:</b> Transparent, orange	100 002
		A30NN-MGM-(4)(4)A-P(7)(7)-NN	A30NN-MGA-(4)(4)A-P(7)(7)-NN		
	2	A30NN-MGM-(4)(4)A-G(7)(7)-NN	A30NN-MGA-(4)(4)A-G(7)(7)-NN		101 102 202
		A30NN-MGM-(4)(4)A-P(7)(7)-NN	A30NN-MGA-(4)(4)A-P(7)(7)-NN		
	3	A30NN-MGM-(4)(4)A-G(7)(7)-NN	A30NN-MGA-(4)(4)A-G(7)(7)-NN		111 112 122 222
		A30NN-MGM-(4)(4)A-P(7)(7)-NN	A30NN-MGA-(4)(4)A-P(7)(7)-NN		

### Lighted, Full-guard Switches

Appearance	Contacts	Momentary action (self-resetting)	Alternate action (self-holding)	(4)(4) Button color	(7)(7)(7) Contacts	(8) LED Lamp color	(9) LED Lamp voltage
		Model	Model				
Brushed metal bezels 	1	A30NL-MGM-(4)(4)A-G(7)(7)-(8)(9)	A30NL-MGA-(4)(4)A-G(7)(7)-(8)(9)	<b>TR:</b> Transparent, red <b>TG:</b> Transparent, green <b>TY:</b> Transparent, yellow <b>TW:</b> Transparent, white <b>TA:</b> Transparent, blue <b>TO:</b> Transparent, orange	100 002	<b>R:</b> Red <b>G:</b> Green <b>Y:</b> Yellow <b>W:</b> White <b>A:</b> Blue <b>O:</b> Orange	<b>A:</b> 6 VAC/DC <b>B:</b> 12 VAC/DC <b>C:</b> 24 VAC/DC <b>D:</b> 100/110/120 VAC <b>E:</b> 200/220/230/240 VAC
		A30NL-MGM-(4)(4)A-P(7)(7)-(8)(9)	A30NL-MGA-(4)(4)A-P(7)(7)-(8)(9)				
	2	A30NL-MGM-(4)(4)A-G(7)(7)-(8)(9)	A30NL-MGA-(4)(4)A-G(7)(7)-(8)(9)		101 102 202		
		A30NL-MGM-(4)(4)A-P(7)(7)-(8)(9)	A30NL-MGA-(4)(4)A-P(7)(7)-(8)(9)				

### Non-lighted, Mushroom Switches

Appearance	Contacts	Momentary action (self-resetting)	Alternate action (self-holding)	(4)(4) Button color	(7)(7)(7) Contacts
		Model	Model		
Brushed metal bezels 	1	A30NN-MMM-(4)(4)A-G(7)(7)-NN	A30NN-MMA-(4)(4)A-G(7)(7)-NN	<b>NR:</b> Opaque, red <b>NG:</b> Opaque, green <b>NY:</b> Opaque, yellow <b>NW:</b> Opaque, white <b>NA:</b> Opaque, blue <b>NB:</b> Opaque, black <b>UR:</b> Transparent, red <b>UG:</b> Transparent, green <b>UY:</b> Transparent, yellow <b>UW:</b> Transparent, white <b>UA:</b> Transparent, blue <b>UO:</b> Transparent, orange	100 002
		A30NN-MMM-(4)(4)A-P(7)(7)-NN	A30NN-MMA-(4)(4)A-P(7)(7)-NN		
	2	A30NN-MMM-(4)(4)A-G(7)(7)-NN	A30NN-MMA-(4)(4)A-G(7)(7)-NN		101 102 202
		A30NN-MMM-(4)(4)A-P(7)(7)-NN	A30NN-MMA-(4)(4)A-P(7)(7)-NN		
	3	A30NN-MMM-(4)(4)A-G(7)(7)-NN	A30NN-MMA-(4)(4)A-G(7)(7)-NN		111 112 122 222
		A30NN-MMM-(4)(4)A-P(7)(7)-NN	A30NN-MMA-(4)(4)A-P(7)(7)-NN		

### Lighted, Mushroom Switches

Appearance	Contacts	Momentary action (self-resetting)	Alternate action (self-holding)	(4)(4) Button color	(7)(7)(7) Contacts	(8) LED Lamp color	(9) LED Lamp voltage
		Model	Model				
Brushed metal bezels 	1	A30NL-MMM-(4)(4)A-G(7)(7)-(8)(9)	A30NL-MMA-(4)(4)A-G(7)(7)-(8)(9)	<b>TR:</b> Transparent, red <b>TG:</b> Transparent, green <b>TY:</b> Transparent, yellow <b>TW:</b> Transparent, white <b>TA:</b> Transparent, blue <b>TO:</b> Transparent, orange	100 002	<b>R:</b> Red <b>G:</b> Green <b>Y:</b> Yellow <b>W:</b> White <b>A:</b> Blue <b>O:</b> Orange	<b>A:</b> 6 VAC/DC <b>B:</b> 12 VAC/DC <b>C:</b> 24 VAC/DC <b>D:</b> 100/110/120 VAC <b>E:</b> 200/220/230/240 VAC
		A30NL-MMM-(4)(4)A-P(7)(7)-(8)(9)	A30NL-MMA-(4)(4)A-P(7)(7)-(8)(9)				
	2	A30NL-MMM-(4)(4)A-G(7)(7)-(8)(9)	A30NL-MMA-(4)(4)A-G(7)(7)-(8)(9)		101 102 202		
		A30NL-MMM-(4)(4)A-P(7)(7)-(8)(9)	A30NL-MMA-(4)(4)A-P(7)(7)-(8)(9)				

**Note:** Normally, the Button and LED Lamp with the same color are combined.  
 However, opaque white is available by combining a white Button and yellow LED. A30N□-□□□-TWA-□□□□-Y□

■ Subassemblies: Refer to pages 59 and 82.  
 (You can order Operation Units, LED Lamps, Mounting Collars, and Contact Blocks individually.)

■ Specifications: Refer to page 60. ■ Dimensions: Refer to page 62.  
 ■ Accessories and tools: Refer to pages 84 to 85.

Pushbutton Switches A22N  
 Selector Switches A22N  
 Key-type Selector Switches A22N  
 Indicators M22N  
 Pushbutton Switches A30N  
 Selector Switches A30N  
 Key-type Selector Switches A30N  
 Subassemblies (Common)  
 Accessories and Tools  
 Safety Precautions

# Ordering Information

## Switch Structure

--- You can order Operation Units, LED Lamps (lighted models only), Mounting Collars, Contact Blocks, and Lighting Units (lighted models only) separately. The same LED Lamps, Mounting Collars, and Contact Blocks are also used for the A22N Series.

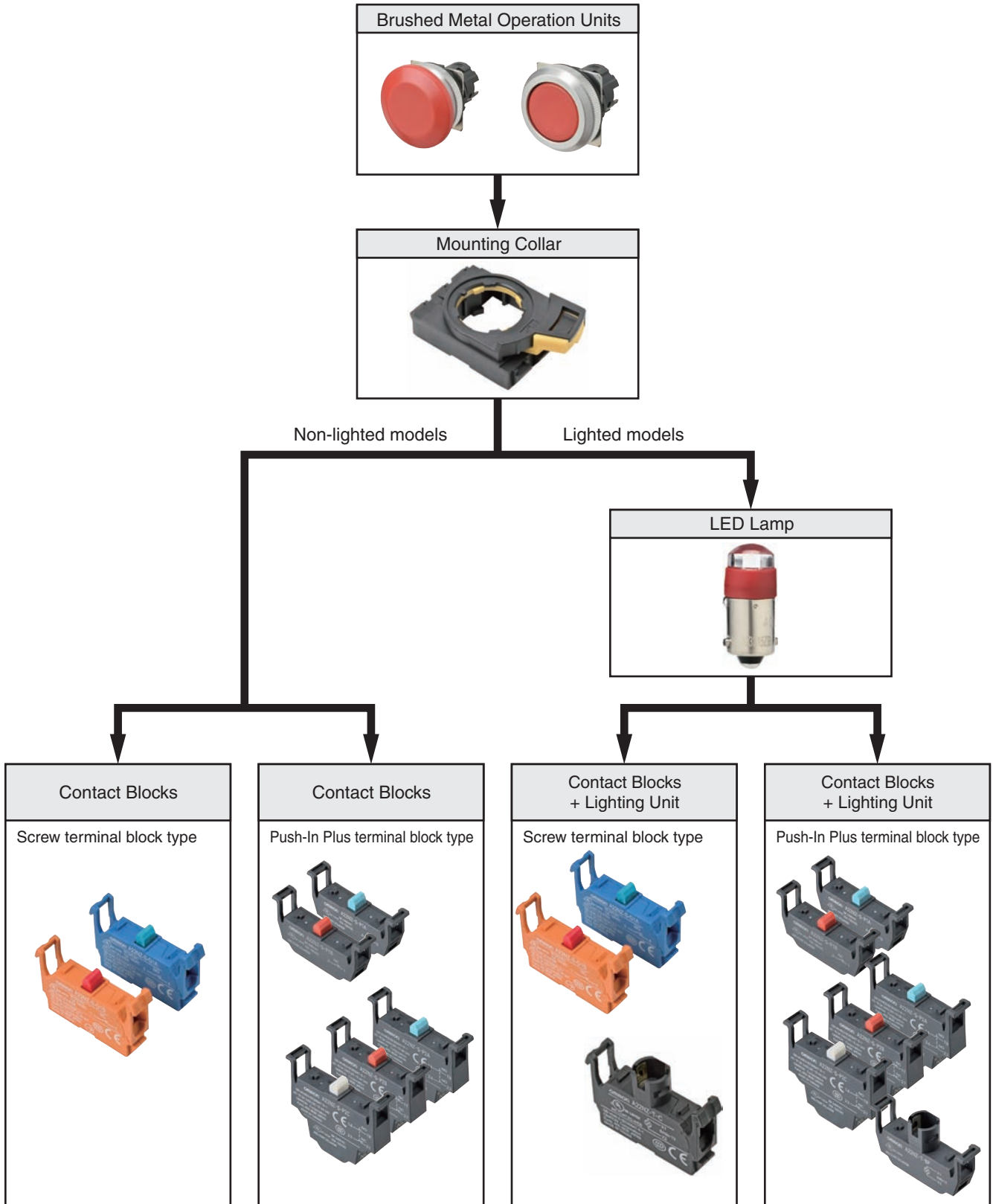

- Specifications: Refer to page 60.
- Subassemblies (Common): Refer to page 82.
- Precautions for correct use: Refer to pages 88 to 99.
- Dimensions: Refer to page 62.
- Accessories and tools: Refer to pages 84 to 85.

Pushbutton Switches A22N  
 Selector Switches A22N  
 Key-type Selector Switches A22N  
 Indicators M22N  
 Pushbutton Switches A30N  
 Selector Switches A30N  
 Key-type Selector Switches A30N  
 Subassemblies (Common)  
 Accessories and Tools  
 Safety Precautions

# Ordering Information

## Subassemblies

-----Please order Operation Units, LED lamps (lighted models only), Mounting Collars, Contact Blocks, and Lighting Units (lighted models only) separately. LED lamps, Mounting Collars, Contact Blocks, and Lighting Units can also be used with the A22N series.

## Operation Units

Bezel material and button shape			Brushed metal, flat		Brushed metal, projected	
			Switch Action		Momentary	Alternate
Lighted/ non-lighted	Transparency	Color	Model	Model	Model	Model
			Non-lighted	Opaque	Red	A30NZ-MNM-NRA
Opaque	Green	A30NZ-MNM-NGA		A30NZ-MNA-NGA	A30NZ-MPM-NGA	A30NZ-MPA-NGA
Opaque	Yellow	A30NZ-MNM-NYA		A30NZ-MNA-NYA	A30NZ-MPM-NYA	A30NZ-MPA-NYA
Opaque	White	A30NZ-MNM-NWA		A30NZ-MNA-NWA	A30NZ-MPM-NWA	A30NZ-MPA-NWA
Opaque	Blue	A30NZ-MNM-NAA		A30NZ-MNA-NAA	A30NZ-MPM-NAA	A30NZ-MPA-NAA
Opaque	Black	A30NZ-MNM-NBA		A30NZ-MNA-NBA	A30NZ-MPM-NBA	A30NZ-MPA-NBA
Transparent	Red	A30NZ-MNM-URA		A30NZ-MNA-URA	A30NZ-MPM-URA	A30NZ-MPA-URA
Transparent	Green	A30NZ-MNM-UGA		A30NZ-MNA-UGA	A30NZ-MPM-UGA	A30NZ-MPA-UGA
Transparent	Yellow	A30NZ-MNM-UYA		A30NZ-MNA-UYA	A30NZ-MPM-UYA	A30NZ-MPA-UYA
Transparent	White	A30NZ-MNM-UWA		A30NZ-MNA-UWA	A30NZ-MPM-UWA	A30NZ-MPA-UWA
Transparent	Blue	A30NZ-MNM-UAA		A30NZ-MNA-UAA	A30NZ-MPM-UAA	A30NZ-MPA-UAA
Lighted	Transparent	Red	A30NZ-MNM-TRA	A30NZ-MNA-TRA	A30NZ-MPM-TRA	A30NZ-MPA-TRA
	Transparent	Green	A30NZ-MNM-TGA	A30NZ-MNA-TGA	A30NZ-MPM-TGA	A30NZ-MPA-TGA
	Transparent	Yellow	A30NZ-MNM-TYA	A30NZ-MNA-TYA	A30NZ-MPM-TYA	A30NZ-MPA-TYA
	Transparent	White	A30NZ-MNM-TWA	A30NZ-MNA-TWA	A30NZ-MPM-TWA	A30NZ-MPA-TWA
	Transparent	Blue	A30NZ-MNM-TAA	A30NZ-MNA-TAA	A30NZ-MPM-TAA	A30NZ-MPA-TAA
	Transparent	Orange	A30NZ-MNM-TOA	A30NZ-MNA-TOA	A30NZ-MPM-TOA	A30NZ-MPA-TOA

Bezel material and button shape			Brushed metal, full-guard		Brushed metal, mushroom	
			Switch Action		Momentary	Alternate
Lighted/ non-lighted	Transparency	Color	Model	Model	Model	Model
			Non-lighted	Opaque	Red	A30NZ-MGM-NRA
Opaque	Green	A30NZ-MGM-NGA		A30NZ-MGA-NGA	A30NZ-MMM-NGA	A30NZ-MMA-NGA
Opaque	Yellow	A30NZ-MGM-NYA		A30NZ-MGA-NYA	A30NZ-MMM-NYA	A30NZ-MMA-NYA
Opaque	White	A30NZ-MGM-NWA		A30NZ-MGA-NWA	A30NZ-MMM-NWA	A30NZ-MMA-NWA
Opaque	Blue	A30NZ-MGM-NAA		A30NZ-MGA-NAA	A30NZ-MMM-NAA	A30NZ-MMA-NAA
Opaque	Black	A30NZ-MGM-NBA		A30NZ-MGA-NBA	A30NZ-MMM-NBA	A30NZ-MMA-NBA
Transparent	Red	A30NZ-MGM-URA		A30NZ-MGA-URA	A30NZ-MMM-URA	A30NZ-MMA-URA
Transparent	Green	A30NZ-MGM-UGA		A30NZ-MGA-UGA	A30NZ-MMM-UGA	A30NZ-MMA-UGA
Transparent	Yellow	A30NZ-MGM-UYA		A30NZ-MGA-UYA	A30NZ-MMM-UYA	A30NZ-MMA-UYA
Transparent	White	A30NZ-MGM-UWA		A30NZ-MGA-UWA	A30NZ-MMM-UWA	A30NZ-MMA-UWA
Transparent	Blue	A30NZ-MGM-UAA		A30NZ-MGA-UAA	A30NZ-MMM-UAA	A30NZ-MMA-UAA
Lighted	Transparent	Red	A30NZ-MGM-TRA	A30NZ-MGA-TRA	A30NZ-MMM-TRA	A30NZ-MMA-TRA
	Transparent	Green	A30NZ-MGM-TGA	A30NZ-MGA-TGA	A30NZ-MMM-TGA	A30NZ-MMA-TGA
	Transparent	Yellow	A30NZ-MGM-TYA	A30NZ-MGA-TYA	A30NZ-MMM-TYA	A30NZ-MMA-TYA
	Transparent	White	A30NZ-MGM-TWA	A30NZ-MGA-TWA	A30NZ-MMM-TWA	A30NZ-MMA-TWA
	Transparent	Blue	A30NZ-MGM-TAA	A30NZ-MGA-TAA	A30NZ-MMM-TAA	A30NZ-MMA-TAA
	Transparent	Orange	A30NZ-MGM-TOA	A30NZ-MGA-TOA	A30NZ-MMM-TOA	A30NZ-MMA-TOA

- Specifications: Refer to page 60.
- Subassemblies (Common): Refer to page 82.
- Precautions for correct use: Refer to pages 88 to 99.
- Dimensions: Refer to page 62.
- Accessories and tools: Refer to pages 84 to 85.

Pushbutton Switches A22N  
 Selector Switches A22N  
 Key-type Selector Switches A22N  
 Indicators M22N  
 Pushbutton Switches A30N  
 Selector Switches A30N  
 Key-type Selector Switches A30N  
 Subassemblies (Common)  
 Accessories and Tools  
 Safety Precautions

# A30NN/A30NL

## Specifications (When the Operation Unit, LED Lamp, Mounting Collar, Contact Blocks, and Lighting Unit Are Combined)

### Certified Safety Standard Ratings

UL 508 (File No. E76675), CSA C22.2 No.14

6 A 240 VAC, 10 A 120 VAC

TÜV (EN60947-5-1)

AC-15 3 A 240 VAC

DC-13 4 A 24 VDC

CCC (GB14048.5)

AC-15 3 A 240 VAC

DC-13 4 A 24 VDC

### Application Standards

UL1059 and UL486E (Push-In Plus terminal block type)

### Ratings

#### Contacts (Standard Load)

<b>Rated insulation voltage</b>		600 V				
<b>Rated carry current</b>		10 A				
<b>Rated voltage</b>		24 V	120 V	240 V	380 V	440 V
<b>AC at 50/60 Hz</b>	Resistive load (AC-12)	10 A	10 A	6 A	2A	2 A
	Inductive load (AC-15)	10 A	6 A	3 A	1.9 A	1.6 A
<b>DC</b>	Resistive load (DC-12)	8 A	2.2 A	1.1 A	---	---
	Inductive load (DC-13)	4 A	1.1 A	0.55 A	---	---

**Note: 1.** The above ratings were obtained by conducting tests under the following conditions.

(1) Ambient temperature: 20 ±2°C

(2) Ambient humidity: 65% ±5% RH

(3) Operating frequency: 30 operations/minute

**2.** Minimum applicable load: 10 mA at 5 VDC.

### LED Lamps

Rated voltage	Applied voltage	Rated current
6 VAC/DC	6 VAC/DC ±10%	Approx. 11 mA (red, orange, yellow, or blue) Approx. 5 mA (white or green)
12 VAC/DC	12 VAC/DC ±10%	Approx. 12 mA (red, orange, yellow, or blue) Approx. 5 mA (white or green)
24 VAC/DC	24 VAC/DC ±10%	Approx. 12 mA (red, orange, yellow, or blue) Approx. 5 mA (white or green)
100 VAC	100 VAC ±10%	Approx. 12 mA (red, orange, yellow, or blue) Approx. 5 mA (white or green)
110 VAC	110 VAC ±10%	
120 VAC	100 to 130 VAC	Approx. 12 mA (red, orange, yellow, or blue) Approx. 5 mA (white or green)
200 VAC	200 VAC ±10%	
220 VAC	220 VAC ±10%	Approx. 12 mA (red, orange, yellow, or blue) Approx. 5 mA (white or green)
230 VAC	230 VAC ±10%	
240 VAC	220 to 250 VAC	

Pushbutton Switches  
A22N

Selector Switches  
A22N

Key-Type Selector Switches  
A22N

Indicators  
M22N

Pushbutton Switches  
A30N

Selector Switches  
A30N

Key-Type Selector Switches  
A30N

Subassemblies  
(Common)

Accessories  
and Tools

Safety  
Precautions

**Specifications** (When the Operation Unit, LED Lamp, Mounting Collar, Contact Blocks, and Lighting Unit Are Combined)

**Characteristics**

Item	Type	Pushbutton Switches	
		Non-lighted models	Lighted models
Allowable operating frequency	Mechanical	60 operations/minute max.	
	Electrical	30 operations/minute max.	
Insulation resistance		100 MΩ min. (at 500 VDC)	Not available for lighting units
Contact resistance		100 mΩ max. (initial value)	
Dielectric strength	Between terminals of same polarity	2,500 VAC at 50/60 Hz for 1 min. (initial value)	Not available for lighting units
	Between each terminal and ground	2,500 VAC at 50/60 Hz for 1 min. (initial value)	
Vibration resistance	Malfunction	10 to 55 Hz, 1.5-mm double amplitude (malfunction within 1 ms)	
Shock resistance	Malfunction	1,000 m/s <sup>2</sup> max. (malfunction within 1 ms)	
Durability	Mechanical	Momentary action: 5,000,000 operations min. Alternate action: 500,000 operations min.	
	Electrical	500,000 operations min. (250 VAC, 3 A, with an inductive load having power factor cos θ = 0.4)	
Ambient operating temperature <sup>*1</sup>		-25 to 70°C	-25 to 55°C
Ambient operating humidity		35% to 85% RH	
Ambient storage temperature <sup>*1</sup>		-40 to 80°C	
Degree of protection <sup>*2</sup>		Conforming to IP66	
Electric shock protection class		Class II	
PTI (tracking characteristic)		175	
Degree of contamination (application environment)		3 (EN 60947-5-1)	
Weight		Approx. 60 g (for 1NC/1NO)	Approx. 75 g (for 1NC/1NO)

\*1. With no icing or condensation.

\*2. Degree of protection from the front of the panel.

**Operating Characteristics (for SPST-NO/SPST-NC)**

Item	Type	Pushbutton Switches
		Lighted/non-lighted
Total travel force (torque) (maximum TTF)		18 N
Total travel (TT)		6 mm max.
Resetting force (torque) (RF)		---

**Examples of Linked Contact Blocks (Screw terminal block type)**

 Contact Blocks

 Lighting Units

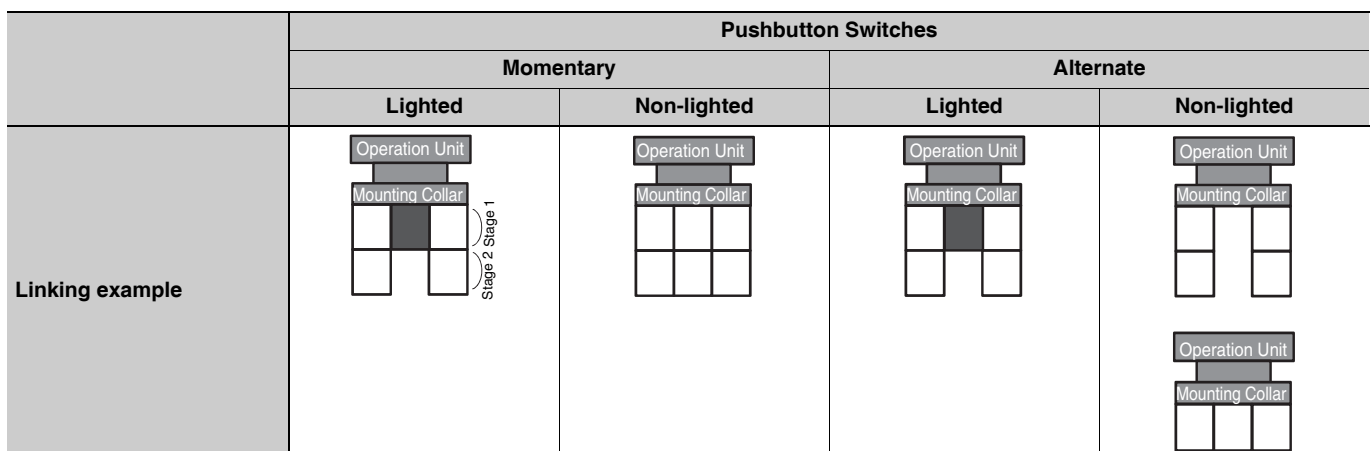

**Note:** If you increase the number of Contact Blocks, evaluate the Switch under actual working conditions before permanent installation and use the Switch within a number of switching operations that will not adversely affect the Switch's performance.

Pushbutton Switches A22N  
 Selector Switches A22N  
 Key-type Selector Switches A22N  
 Indicators M22N  
 Pushbutton Switches A30N  
 Selector Switches A30N  
 Key-type Selector Switches A30N  
 Subassemblies (Common)  
 Accessories and Tools  
 Safety Precautions

# A30NN/A30NL

## Dimensions

(Unit: mm)

### Lighted and Non-lighted Pushbutton Switches

#### Flat Switches with Brushed Metal Bezels

A30N□-MN□-N□A-G□-□□

A30N□-MN□-N□A-P□-□□

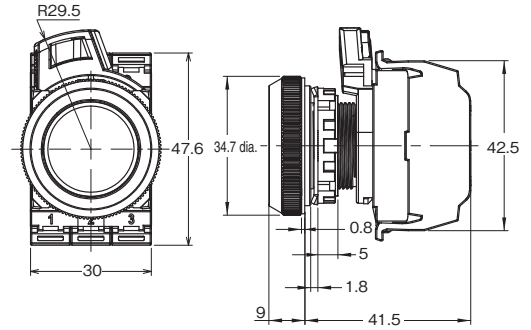
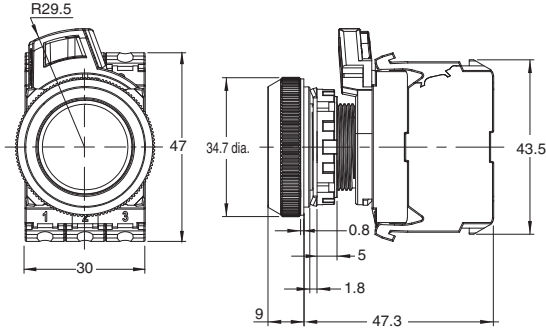
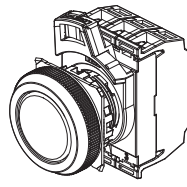
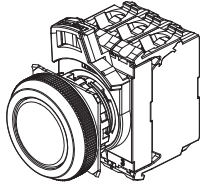

A30N□-MN□-T□A-G□-□□  
A30N□-MN□-U□A-G□-□□

A30N□-MN□-T□A-P□-□□  
A30N□-MN□-U□A-P□-□□

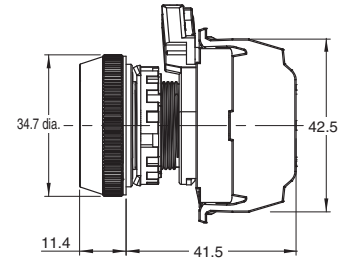
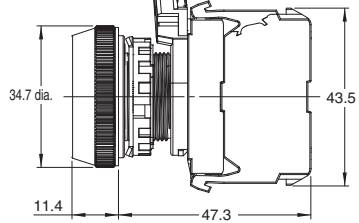
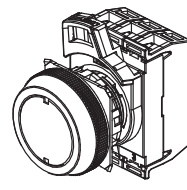
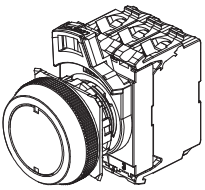

#### Projected Switches with Brushed Metal Bezels

A30N□-MP□-□□A-G□-□□

A30N□-MP□-□□A-P□-□□

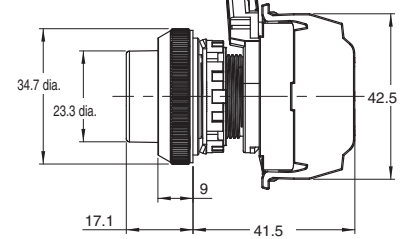
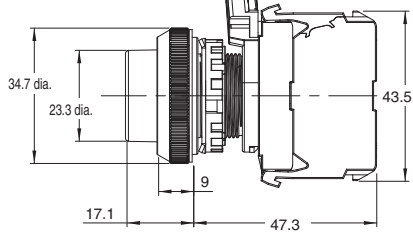
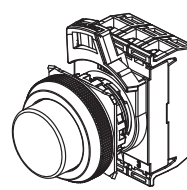
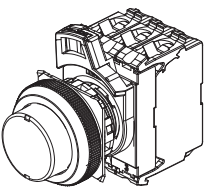

#### Full-guard Switches with Brushed Metal Bezels

A30N□-MG□-□□A-G□-□□

A30N□-MG□-□□A-P□-□□

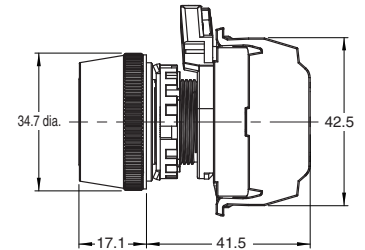
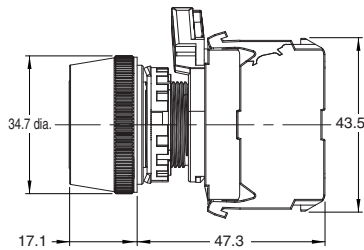
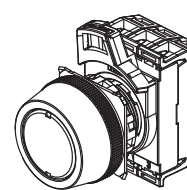
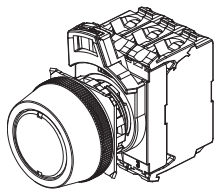

Pushbutton Switches  
A22N

Selector Switches  
A22N

Key-Type Selector Switches  
A22N

Indicators  
M22N

Pushbutton Switches  
A30N

Selector Switches  
A30N

Key-Type Selector Switches  
A30N

Subassemblies  
(Common)

Accessories  
and Tools

Safety  
Precautions

Mushroom Switches with Brushed Metal Bezels

A30N□-MM□-□□A-G□-□□

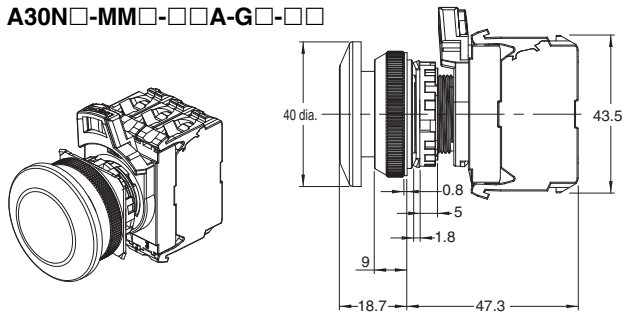

A30N□-MM□-□□A-P□-□□

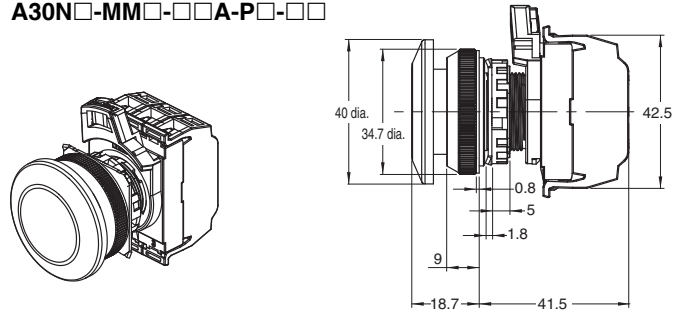

Depth with Linked Units  
(Screw terminal block type)

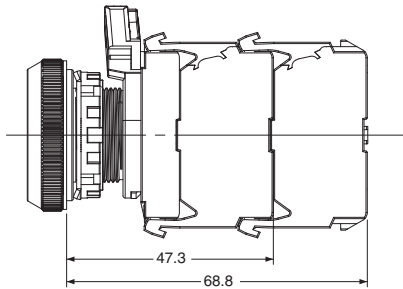

Depth when a double-contact unit is mounted  
(Push-In Plus terminal block type)

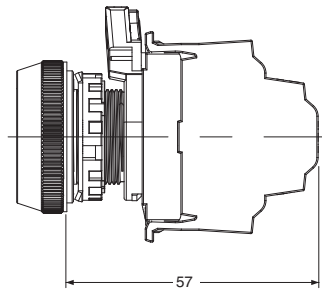

Terminal Arrangement

BOTTOM VIEW (Screw terminal block type)

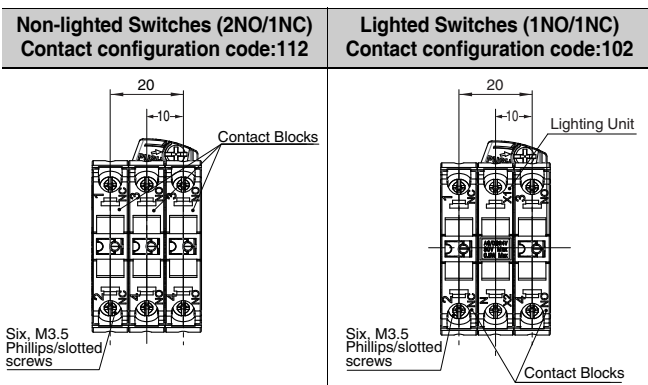

Terminal Connection Diagrams

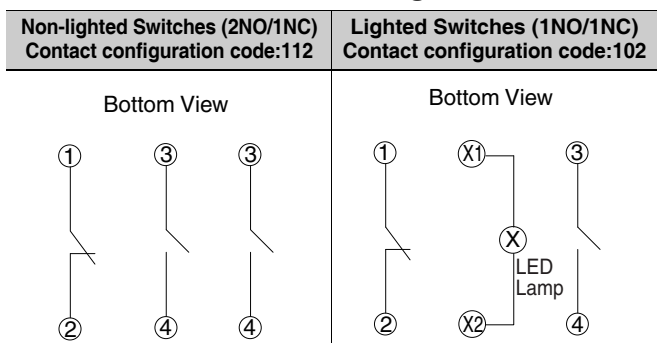

Note: The above shows a terminal connection diagram for a screw terminal block type.

BOTTOM VIEW (Push-In Plus terminal block type)

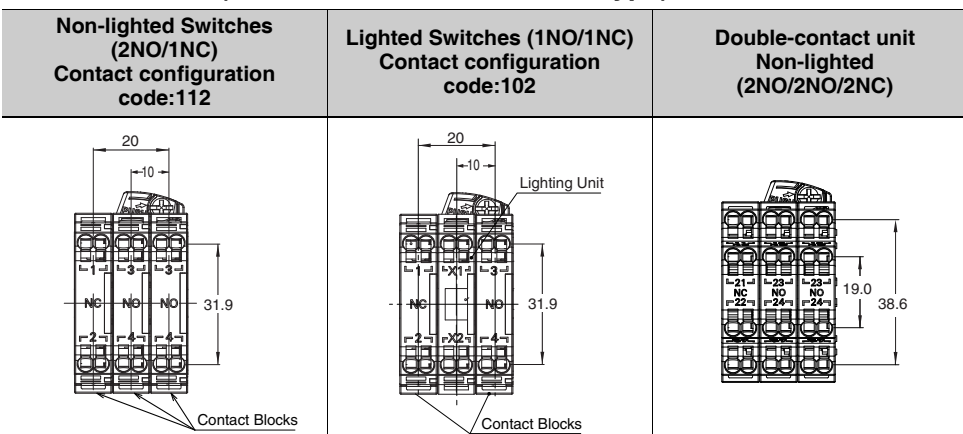

Pushbutton Switches  
A22N

Selector Switches  
A22N

Key-type Selector Switches  
A22N

Indicators  
M22N

Pushbutton Switches  
A30N

Selector Switches  
A30N

Key-type Selector Switches  
A30N

Subassemblies (Common)

Accessories and Tools

Safety Precautions

# Selector Switches A30NS/A30NW

**30-mm dia. Knob-type Selector Switches**  
Control panel miniaturization through a more compact design and modified wiring direction.  
**Addition of Push-In Plus terminal blocks for easy wiring.**  
**Workability and safety improvements.**



### Easy to Use

- You can connect up to three Contact Blocks in one stage for multistage expansion. (Screw terminal block type)
- Screw terminal structure is compatible with round crimp terminals. (Screw terminal block type)

### Safety

- Easy-to-operate lock lever for secure locking.
- Easy-mounting Contact Blocks provide finger protection.
- No loose connections of wiring means maintenance-free use. (Push-In Plus terminal block type)

Refer to *Safety Precautions for All Pushbutton Switches/Indicators and Safety Precautions* on page 88.

### Product Lineup

- The buttons and bezels come in a wide variety of colors and shapes.

## Operation Unit Colors

Non-lighted Switches	A30NS-□□□-N□ Opaque	Operation Unit Colors							
		Red	Green	Yellow	White	Blue	Black		
Lighted Switches	A30NW-□□□-T□ Transparent	When not lit	Red	Green	Yellow	White	Blue	Orange	White
			Red	Green	Yellow	White	Blue	Orange	Opaque white*
		When lit	Red	Green	Yellow	White	Blue	Orange	Opaque white*
			Red	Green	Yellow	White	Blue	Orange	Opaque white*

\* The colors when the Switches are lit are for transparent white Operation Units (code: TW) and yellow LED Lamps (code: Y).

## List of Models

Screw Terminal Blocks/Push-In Plus Terminal Blocks			
Brushed metal bezels			
A30NS		A30NW	
Non-lighted	Lighted	Non-lighted	Lighted
Two Positions	Three Positions	Two Positions	Three Positions

Pushbutton Switches  
A22N

Selector Switches  
A22N

Key-type Selector Switches  
A22N

Indicators  
M22N

Pushbutton Switches  
A30N

Selector Switches  
A30N

Key-type Selector Switches  
A30N

Subassemblies  
(Common)

Accessories  
and Tools

Safety  
Precautions



# Model Number Structure

**Model Number Legend** - Please order Operation Units, LED lamps (lighted models only), Mounting Collars, Contact Blocks, and Lighting Units (lighted models only) separately. LED lamps, Mounting Collars, Contact Blocks, and Lighting Units can also be used with the A22N series.

## Model Numbers for Sets

A30N <sup>(1)</sup>W - <sup>(2)</sup>2M <sup>(3)</sup>M - <sup>(4)</sup>NR <sup>(5)</sup>A - <sup>(6)</sup>G <sup>(7)</sup>101 - <sup>(8)</sup>R <sup>(9)</sup>A

### (1) Type

Code	Type
S	Non-lighted
W	Lighted

### (2) Number of Positions and Bezel Material

Code	No. of positions	Bezel material
2M	2	Brushed metal
3M	3	Brushed metal

### (3) Reset Method

Code	Reset method		
M	Manual	Two-position manual	
		Three-position manual	
L	Automatic reset on left	Two-position automatic	
		Three-position left automatic	
R	Automatic reset on right	Three-position right automatic	
B	Automatic reset on left and right	Three-position left or right automatic	

### (4) Operation Unit Transparency and Color and (8) LED Lamp Color

Lighted/non-lighted	Code (4)	Code (8)	Transparency	Operation Unit color	LED Lamp color
Non-lighted	NR	N	Opaque	Red	---
	NG			Green	
	NY			Yellow	
	NW			White	
	NA			Blue	
	NB			Black	
Lighted	TR	R	Transparent	Red	Red
	TG	G		Green	Green
	TY	Y		Yellow	Yellow
	TW	W		White	White
	TA	A		Blue	Blue
	TO	O		Orange	Orange
	TW	Y		White*	Yellow

\* The color is opaque white when the Switch is lit.

### (5) Degree of Protection

Code	Protection
A	Conforming to IP66, NEMA 4X, NEMA13

### (6) Contacts and Terminals Specifications

Code	Specification
G	General/Screw Terminal Block
P	General/Push-In Plus Terminal Block

### (7) Contact Configuration

Code	Contact Blocks		Non-lighted						Lighted				
			Unit position			No. of positions			Unit position			No. of positions	
	NO	NC	1	2	3	Two positions	Three positions	1	2	3	Two positions	Three positions	
100	1	0	NO	---	---	Yes		NO	Lighting Unit	---	Yes		
002	0	1	---	---	NC	Yes		---	Lighting Unit	NC	Yes		
101	2	0	NO	---	NO	Yes	Yes	NO	Lighting Unit	NO	Yes	Yes	
102	1	1	NO	---	NC	Yes	Yes	NO	Lighting Unit	NC	Yes	Yes	
201	1	1	NC	---	NO		Yes	NC	Lighting Unit	NO		Yes	
202	0	2	NC	---	NC	Yes	Yes	NC	Lighting Unit	NC	Yes	Yes	
110	2	0	NO	NO	---		Yes						
111	3	0	NO	NO	NO	Yes	Yes						
112	2	1	NO	NO	NC	Yes	Yes						
210	1	1	NC	NO	---		Yes						
211	2	1	NC	NO	NO		Yes						
212	1	2	NC	NO	NC		Yes						
011	2	0	---	NO	NO		Yes						
012	1	1	---	NO	NC		Yes						
120	1	1	NO	NC	---		Yes						
121	2	1	NO	NC	NO		Yes						
122	1	2	NO	NC	NC	Yes	Yes						
220	0	2	NC	NC	---		Yes						
221	1	2	NC	NC	NO		Yes						
222	0	3	NC	NC	NC	Yes	Yes						
021	1	1	---	NC	NO		Yes						
022	0	2	---	NC	NC		Yes						

**Note:** 1. NO (blue): Normally open, NC (orange): Normally closed.  
2. Refer to the following figure for the Unit positions.

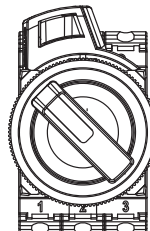

### (9) LED Lamp Voltage

Code	LED Lamp voltage
N	Non-lighted
A	6 VAC/DC
B	12 VAC/DC
C	24 VAC/DC
D	100/110/120 VAC
E	200/220/230/240 VAC

- Specifications: Refer to page 60.
- Dimensions: Refer to page 72.
- Accessories and tools: Refer to pages 84 to 85.

- Characteristics: Refer to page 71.
- Subassemblies (Common): Refer to page 82.
- Precautions for correct use: Refer to pages 88 to 99.

Pushbutton Switches  
A22N  
Selector Switches  
A22N  
Key-type Selector Switches  
A22N  
Indicators  
M22N  
Pushbutton Switches  
A30N  
Selector Switches  
A30N  
Key-type Selector Switches  
A30N  
Subassemblies (Common)  
Accessories and Tools  
Safety Precautions

# A30NS/A30NW

## Ordering Information

**Model Numbers for Sets** - - - Shipped as a set that includes the Operation Unit, Mounting Collar, and Contact Block.

### Non-lighted, Two-position, Selector Switches

Appearance	Bezel material	No. of outputs	Model	(3) Reset method	(4)(4) Operation Unit color	(7)(7)(7) Contact configuration					
Brushed metal bezels 	2M	1	A30NS-2M(3)-(4)(4)A-G(7)(7)-NN	M: Manual L: Automatic reset on left	NR: Opaque red NG: Opaque green NY: Opaque yellow NW: Opaque white NA: Opaque blue NB: Opaque black	100 002					
			A30NS-2M(3)-(4)(4)A-P(7)(7)-NN								
		2	A30NS-2M(3)-(4)(4)A-G(7)(7)-NN			M: Manual L: Automatic reset on left	NR: Opaque red NG: Opaque green NY: Opaque yellow NW: Opaque white NA: Opaque blue NB: Opaque black	102 101 202			
			A30NS-2M(3)-(4)(4)A-P(7)(7)-NN								
			3					A30NS-2M(3)-(4)(4)A-G(7)(7)-NN	M: Manual L: Automatic reset on left	NR: Opaque red NG: Opaque green NY: Opaque yellow NW: Opaque white NA: Opaque blue NB: Opaque black	111 222 122 112
								A30NS-2M(3)-(4)(4)A-P(7)(7)-NN			

### Non-lighted, Three-position, Selector Switches

Appearance	Bezel material	No. of outputs	Model	(3) Reset method	(4)(4) Operation Unit color	(7)(7)(7) Contact configuration				
Brushed metal bezels 	3M	2	A30NS-3M(3)-(4)(4)A-G(7)(7)-NN	M: Manual L: Automatic reset on left R: Automatic reset on right B: Automatic reset on left and right	NR: Opaque red NG: Opaque green NY: Opaque yellow NW: Opaque white NA: Opaque blue NB: Opaque black	110 011 101 220 022 202 120 102 210 201 012 021				
			A30NS-3M(3)-(4)(4)A-P(7)(7)-NN							
			3				A30NS-3M(3)-(4)(4)A-G(7)(7)-NN	M: Manual L: Automatic reset on left R: Automatic reset on right B: Automatic reset on left and right	NR: Opaque red NG: Opaque green NY: Opaque yellow NW: Opaque white NA: Opaque blue NB: Opaque black	111 222 122 212 221 211 121 112
							A30NS-3M(3)-(4)(4)A-P(7)(7)-NN			

■ Subassemblies: Refer to pages 69 and 82.  
 (You can order Operation Units, LED Lamps, Mounting Collars, and Contact Blocks individually.)

■ Specifications: Refer to page 60. ■ Characteristics: Refer to page 71.  
 ■ Dimensions: Refer to page 72.  
 ■ Accessories and tools: Refer to pages 84 to 85.

Pushbutton Switches A22N  
 Selector Switches A22N  
 Key-Type Selector Switches A22N  
 Indicators M22N  
 Pushbutton Switches A30N  
 Selector Switches A30N  
 Key-Type Selector Switches A30N  
 Subassemblies (Common)  
 Accessories and Tools  
 Safety Precautions

## Ordering Information

**Model Numbers for Sets** - - - Shipped as a set that includes the Operation Unit, LED Lamp, Mounting Collar, Contact Block, and Lighting Unit.

### Lighted, Two-position, Selector Switches

Appearance	Bezel material	No. of outputs	Model	(3) Reset method	(4)(4) Operation Unit color	(7)(7)(7) Contact Configuration	(8) LED Lamp color	(9) LED Lamp voltage
Brushed metal bezels 	2M	1	A30NW-2M(3)-(4)(4)A-G(7)(7)-(8)(9)	M: Manual L: Automatic reset on left	TR: Transparent red TG: Transparent green TY: Transparent yellow TW: Transparent white TA: Transparent blue TO: Transparent orange	100 002	R: Red G: Green Y: Yellow A: Blue O: Orange W: White	A: 6 VAC/DC B: 12 VAC/DC C: 24 VAC/DC D: 100/110/120 VAC E: 200/220/230/240 VAC
			A30NW-2M(3)-(4)(4)A-P(7)(7)-(8)(9)					
		2	A30NW-2M(3)-(4)(4)A-G(7)(7)-(8)(9)					
			A30NW-2M(3)-(4)(4)A-P(7)(7)-(8)(9)					

### Lighted, Three-position, Selector Switches

Appearance	Bezel material	No. of outputs	Model	(3) Reset method	(4)(4) Operation Unit color	(7)(7)(7) Contact Configuration	(8) LED Lamp color	(9) LED Lamp voltage
Brushed metal bezels 	3M	2	A30NW-3M(3)-(4)(4)A-G(7)(7)-(8)(9)	M: Manual L: Automatic reset on left R: Automatic reset on right B: Automatic reset on left and right	TR: Transparent red TG: Transparent green TY: Transparent yellow TW: Transparent white TA: Transparent blue TO: Transparent orange	101 202 102 201	R: Red G: Green Y: Yellow A: Blue O: Orange W: White	A: 6 VAC/DC B: 12 VAC/DC C: 24 VAC/DC D: 100/110/120 VAC E: 200/220/230/240 VAC
			A30NW-3M(3)-(4)(4)A-P(7)(7)-(8)(9)					

**Note:** Normally, the Operation Unit and LED Lamp with the same color are combined.  
 However, opaque white is available by combining a white Operation Unit and yellow LED. A30N□-□□□-TWA-□□□□-Y□

■ Subassemblies: Refer to pages 69 and 82.  
 (You can order Operation Units, LED Lamps, Mounting Collars, and Contact Blocks individually.)

■ Specifications: Refer to page 60. ■ Characteristics: Refer to page 71.  
 ■ Dimensions: Refer to page 72.  
 ■ Accessories and tools: Refer to pages 84 to 85.

Pushbutton Switches  
A22N  
Selector Switches  
A22N  
Key-type Selector Switches  
A22N  
Indicators  
M22N  
Pushbutton Switches  
A30N  
Selector Switches  
A30N  
Key-type Selector Switches  
A30N  
Subassemblies (Common)  
Accessories and Tools  
Safety Precautions

# Ordering Information

**Subassemblies** - - - - Please order Operation Units, LED lamps (lighted models only), Mounting Collars, Contact Blocks, and Lighting Units (lighted models only) separately. LED lamps, Mounting Collars, Contact Blocks, and Lighting Units can also be used with the A22N series.

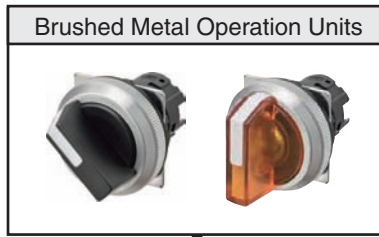

Non-lighted models      Lighted models

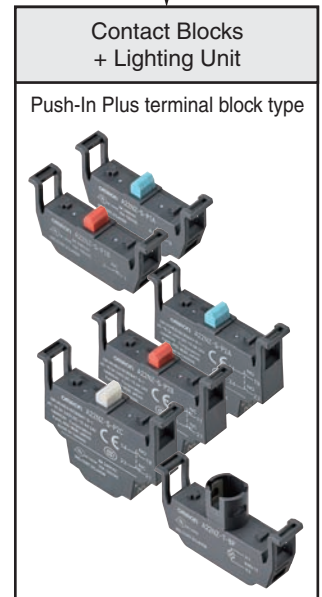
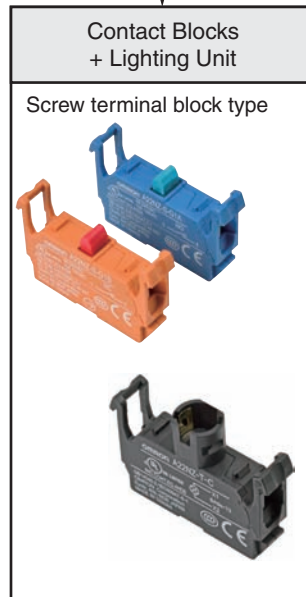
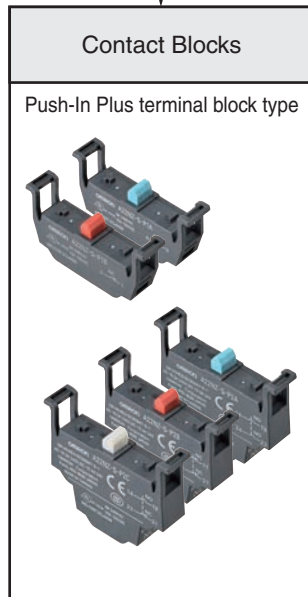
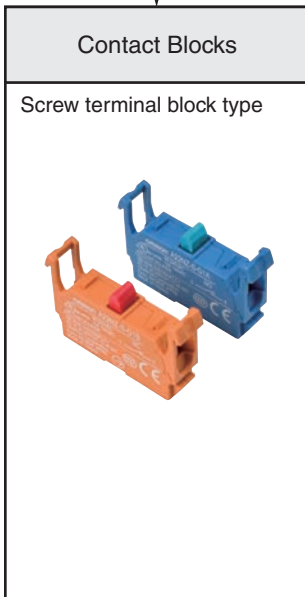

- Specifications: Refer to page 60.
- Dimensions: Refer to page 72.
- Accessories and tools: Refer to pages 84 to 85.
- Characteristics: Refer to page 71.
- Subassemblies (Common): Refer to page 82.
- Precautions for correct use: Refer to pages 88 to 99.

Pushbutton Switches  
A22N

Selector Switches  
A22N

Key-type Selector Switches  
A22N

Indicators  
M22N

Pushbutton Switches  
A30N

Selector Switches  
A30N

Key-type Selector Switches  
A30N

Subassemblies  
(Common)







Accessories  
and Tools

Safety  
Precautions







# Ordering Information

**Subassemblies** - - - - - Please order Operation Units, LED lamps (lighted models only), Mounting Collars, Contact Blocks, and Lighting Units (lighted models only) separately. LED lamps, Mounting Collars, Contact Blocks, and Lighting Units can also be used with the A22N series.

## Operation Units Non-lighted Switches

No. of positions	Reset method	Operation Unit color	Bezel material and shape	Model		
						
2	Manual	Opaque red		A30NZ-2MM-NRA		
	Automatic reset on left			A30NZ-2ML-NRA		
3	Manual			A30NZ-3MM-NRA		
	Automatic reset on left			A30NZ-3ML-NRA		
	Automatic reset on right			A30NZ-3MR-NRA		
	Automatic reset on left and right			A30NZ-3MB-NRA		
2	Manual			Opaque green		A30NZ-2MM-NGA
	Automatic reset on left					A30NZ-2ML-NGA
3	Manual					A30NZ-3MM-NGA
	Automatic reset on left					A30NZ-3ML-NGA
	Automatic reset on right					A30NZ-3MR-NGA
	Automatic reset on left and right					A30NZ-3MB-NGA
2	Manual	Opaque yellow				A30NZ-2MM-NYA
	Automatic reset on left					A30NZ-2ML-NYA
3	Manual					A30NZ-3MM-NYA
	Automatic reset on left					A30NZ-3ML-NYA
	Automatic reset on right					A30NZ-3MR-NYA
	Automatic reset on left and right					A30NZ-3MB-NYA
2	Manual			Opaque white		A30NZ-2MM-NWA
	Automatic reset on left					A30NZ-2ML-NWA
3	Manual					A30NZ-3MM-NWA
	Automatic reset on left					A30NZ-3ML-NWA
	Automatic reset on right					A30NZ-3MR-NWA
	Automatic reset on left and right					A30NZ-3MB-NWA
2	Manual	Opaque blue				A30NZ-2MM-NAA
	Automatic reset on left					A30NZ-2ML-NAA
3	Manual					A30NZ-3MM-NAA
	Automatic reset on left					A30NZ-3ML-NAA
	Automatic reset on right					A30NZ-3MR-NAA
	Automatic reset on left and right					A30NZ-3MB-NAA
2	Manual			Opaque black		A30NZ-2MM-NBA
	Automatic reset on left					A30NZ-2ML-NBA
3	Manual					A30NZ-3MM-NBA
	Automatic reset on left					A30NZ-3ML-NBA
	Automatic reset on right					A30NZ-3MR-NBA
	Automatic reset on left and right					A30NZ-3MB-NBA

## Lighted Switches

No. of positions	Reset method	Operation Unit color	Bezel material and shape	Model		
						
2	Manual	Transparent red		A30NZ-2MM-TRA		
	Automatic reset on left			A30NZ-2ML-TRA		
3	Manual			A30NZ-3MM-TRA		
	Automatic reset on left			A30NZ-3ML-TRA		
	Automatic reset on right			A30NZ-3MR-TRA		
	Automatic reset on left and right			A30NZ-3MB-TRA		
2	Manual			Transparent green		A30NZ-2MM-TGA
	Automatic reset on left					A30NZ-2ML-TGA
3	Manual					A30NZ-3MM-TGA
	Automatic reset on left					A30NZ-3ML-TGA
	Automatic reset on right					A30NZ-3MR-TGA
	Automatic reset on left and right					A30NZ-3MB-TGA
2	Manual	Transparent yellow				A30NZ-2MM-TYA
	Automatic reset on left					A30NZ-2ML-TYA
3	Manual					A30NZ-3MM-TYA
	Automatic reset on left					A30NZ-3ML-TYA
	Automatic reset on right					A30NZ-3MR-TYA
	Automatic reset on left and right					A30NZ-3MB-TYA
2	Manual			Transparent white		A30NZ-2MM-TWA
	Automatic reset on left					A30NZ-2ML-TWA
3	Manual					A30NZ-3MM-TWA
	Automatic reset on left					A30NZ-3ML-TWA
	Automatic reset on right					A30NZ-3MR-TWA
	Automatic reset on left and right					A30NZ-3MB-TWA
2	Manual	Transparent blue				A30NZ-2MM-TAA
	Automatic reset on left					A30NZ-2ML-TAA
3	Manual					A30NZ-3MM-TAA
	Automatic reset on left					A30NZ-3ML-TAA
	Automatic reset on right					A30NZ-3MR-TAA
	Automatic reset on left and right					A30NZ-3MB-TAA
2	Manual			Transparent orange		A30NZ-2MM-TOA
	Automatic reset on left					A30NZ-2ML-TOA
3	Manual					A30NZ-3MM-TOA
	Automatic reset on left					A30NZ-3ML-TOA
	Automatic reset on right					A30NZ-3MR-TOA
	Automatic reset on left and right					A30NZ-3MB-TOA

- Specifications: Refer to page 60.
- Dimensions: Refer to page 72.
- Accessories and tools: Refer to pages 84 to 85.

- Characteristics: Refer to page 71.
- Subassemblies (Common): Refer to page 82.
- Precautions for correct use: Refer to pages 88 to 99.

Pushbutton Switches  
A22N

Selector Switches  
A22N

Key-type Selector Switches  
A22N

Indicators  
M22N

Pushbutton Switches  
A30N

Selector Switches  
A30N

Key-type Selector Switches  
A30N

Subassemblies (Common)

Accessories and Tools

Safety Precautions

# A30NS/A30NW

## Specifications

### Certified Safety Standard Ratings

UL 508 (File No. E76675), CSA C22.2 No.14

6 A 240 VAC, 10 A 120 VAC

TÜV (EN60947-5-1)

AC-15 3 A 240 VAC

DC-13 4 A 24 VDC

CCC (GB14048.5)

AC-15 3 A 240 VAC

DC-13 4 A 24 VDC

### Application Standards

UL1059 and UL486E (Push-In Plus terminal block type)

### Ratings

#### Contacts (Standard Load)

Rated insulation voltage		600 V				
Rated carry current		10 A				
Rated voltage		24 V	120 V	240 V	380 V	440 V
AC at 50/60 Hz	Resistive load (AC-12)	10 A	10 A	6 A	2A	2 A
	Inductive load (AC-15)	10 A	6 A	3 A	1.9 A	1.6 A
DC	Resistive load (DC-12)	8 A	2.2 A	1.1 A	---	---
	Inductive load (DC-13)	4 A	1.1 A	0.55 A	---	---

**Note: 1.** The above ratings were obtained by conducting tests under the following conditions.

(1) Ambient temperature: 20 ±2°C

(2) Ambient humidity: 65% ±5% RH

(3) Operating frequency: 30 operations/minute

**2.** Minimum applicable load: 10 mA at 5 VDC.

### LED Lamps

Rated voltage	Applied voltage	Rated current
6 VAC/DC	6 VAC/DC ±10%	Approx. 11 mA (red, orange, yellow, or blue) Approx. 5 mA (white or green)
12 VAC/DC	12 VAC/DC ±10%	Approx. 12 mA (red, orange, yellow, or blue) Approx. 5 mA (white or green)
24 VAC/DC	24 VAC/DC ±10%	Approx. 12 mA (red, orange, yellow, or blue) Approx. 5 mA (white or green)
100 VAC	100 VAC ±10%	Approx. 12 mA (red, orange, yellow, or blue) Approx. 5 mA (white or green)
110 VAC	110 VAC ±10%	
120 VAC	100 to 130 VAC	
200 VAC	200 VAC ±10%	
220 VAC	220 VAC ±10%	Approx. 12 mA (red, orange, yellow, or blue) Approx. 5 mA (white or green)
230 VAC	230 VAC ±10%	
240 VAC	220 to 250 VAC	

Pushbutton Switches  
A22N

Selector Switches  
A22N

Key-Type Selector Switches  
A22N

Indicators  
M22N

Pushbutton Switches  
A30N

Selector Switches  
A30N

Key-Type Selector Switches  
A30N

Subassemblies  
(Common)

Accessories  
and Tools

Safety  
Precautions

**Specifications** (When the Operation Unit, LED Lamp, Mounting Collar, Contact Blocks, and Lighting Unit Are Combined)

**Characteristics**

Item	Type	Selector Switches	
		Non-lighted models	Lighted models
Allowable operating frequency	Mechanical	30 operations/minute max.	
	Electrical	30 operations/minute max.	
Insulation resistance		100 MΩ min. (at 500 VDC)	Not available for lighting units
Contact resistance		100 mΩ max. (initial value)	
Dielectric strength	Between terminals of same polarity	2,500 VAC at 50/60 Hz for 1 min. (initial value)	Not available for lighting units
	Between each terminal and ground	2,500 VAC at 50/60 Hz for 1 min. (initial value)	
Vibration resistance	Malfunction	10 to 55 Hz, 1.5-mm double amplitude (malfunction within 1 ms)	
Shock resistance	Malfunction	1,000 m/s <sup>2</sup> max. (malfunction within 1 ms)	
Durability	Mechanical	500,000 operations min. (Switches with 3 positions: 300,000 operations min.)	
	Electrical	500,000 operations min. (Switches with 3 positions: 300,000 operations min.) (250 VAC, 3 A, with an inductive load having power factor cos θ = 0.4)	
Ambient operating temperature <sup>*1</sup>		-25 to 70°C	-25 to 55°C
Ambient operating humidity		35% to 85% RH	
Ambient storage temperature <sup>*1</sup>		-40 to 80°C	
Degree of protection <sup>*2</sup>		Conforming to IP66	
Electric shock protection class		Class II	
PTI (tracking characteristic)		175	
Degree of contamination (application environment)		3 (EN 60947-5-1)	
Weight		Approx. 60 g (for 1NC/1NO)	Approx. 75 g (for 1NC/1NO)

\*1. With no icing or condensation.

\*2. Degree of protection from the front of the panel.

**Operating Characteristics (for SPST-NO/SPST-NC)**

Item	Type	Selector Switches	
		Manual reset	Automatic reset
Total travel force (torque) (maximum TTF)		0.6 N·m	0.6 N·m
Total travel (TT)		2 positions: Approx. 90°, 3 positions: Approx. 45°	
Resetting force (torque) (RF)		0.5 N·m max.	---

**Examples of Linked Contact Blocks (Screw terminal block type)**

 Contact Blocks  Lighting Units

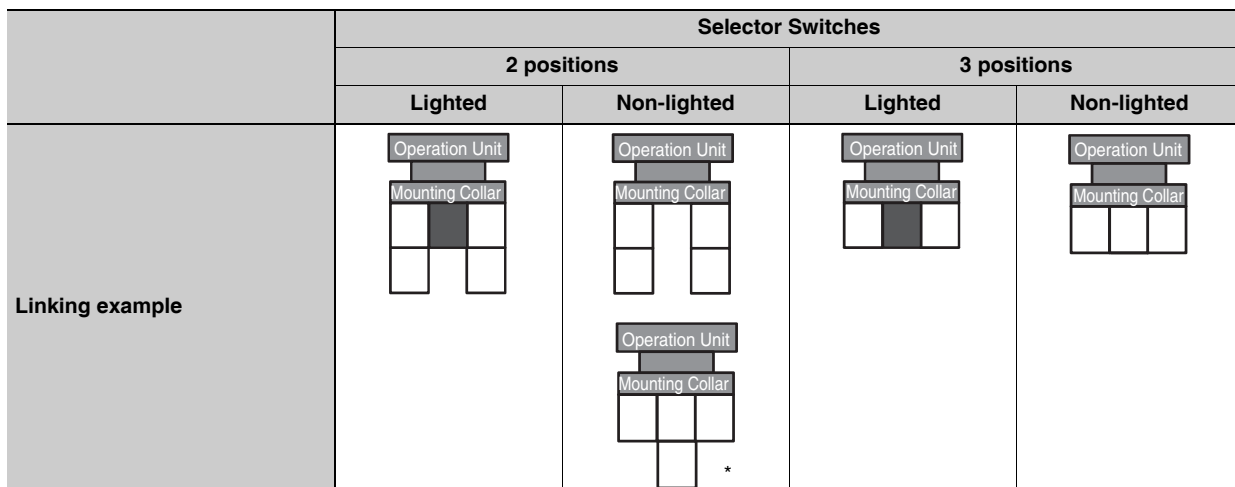

\* If you use three Contact Blocks in stage 1, you can add one more Contact Block in the middle of stage 2.

**Note:** If you increase the number of Contact Blocks, evaluate the Switch under actual working conditions before permanent installation and use the Switch within a number of switching operations that will not adversely affect the Switch's performance.

Pushbutton Switches  
A22N  
Selector Switches  
A22N  
Key-type Selector Switches  
A22N  
Indicators  
M22N  
Pushbutton Switches  
A30N  
Selector Switches  
A30N  
Key-type Selector Switches  
A30N  
Subassemblies (Common)  
Accessories and Tools  
Safety Precautions

# A30NS/A30NW

## Dimensions

(Unit: mm)

### Lighted and Non-lighted Selection Switches

#### Two-position Switches with Brushed Metal Bezels

A30N□-2M□-□□A-G□-□□

A30N□-2M□-□□A-P□-□□

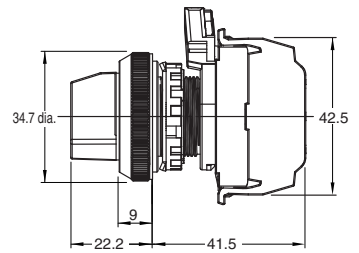
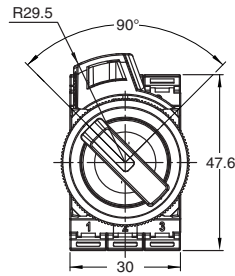
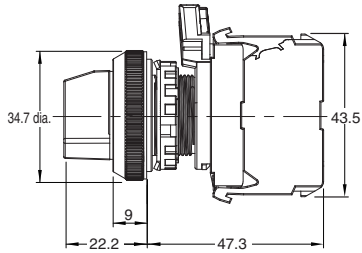
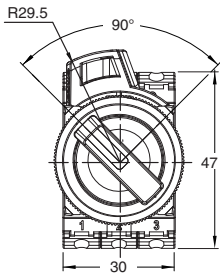
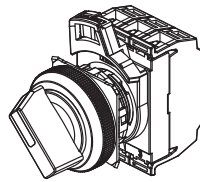
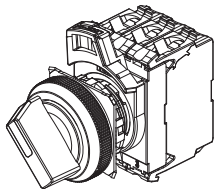

#### Three-position Switches with Brushed Metal Bezels

A30N□-3M□-□□A-G□-□□

A30N□-3M□-□□A-P□-□□

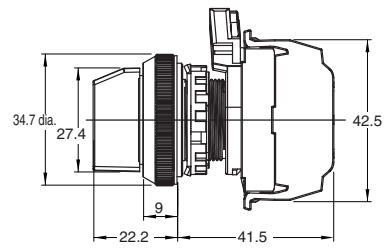
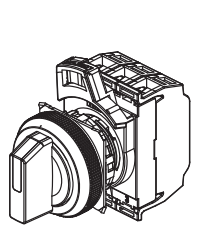
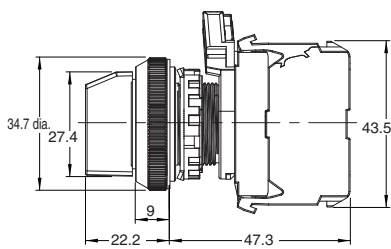
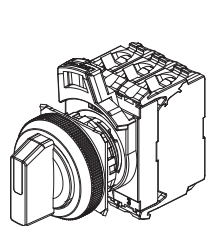

#### Depth with Linked Units (Screw terminal block type)

#### Depth when a double-contact unit is mounted (Push-In Plus terminal block type)

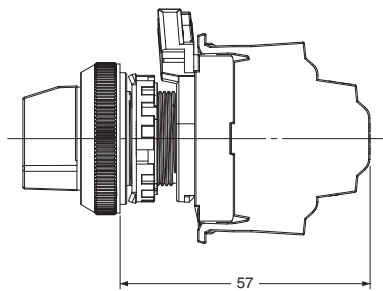
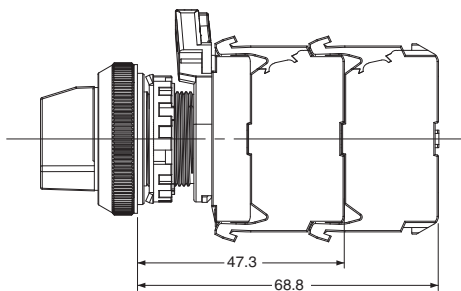

Pushbutton Switches  
A22N

Selector Switches  
A22N

Key-type Selector Switches  
A22N

Indicators  
M22N

Pushbutton Switches  
A30N

Selector Switches  
A30N

Key-type Selector Switches  
A30N

Subassemblies  
(Common)

Accessories  
and Tools

Safety  
Precautions



### Terminal Arrangement

#### BOTTOM VIEW (Screw terminal block type)

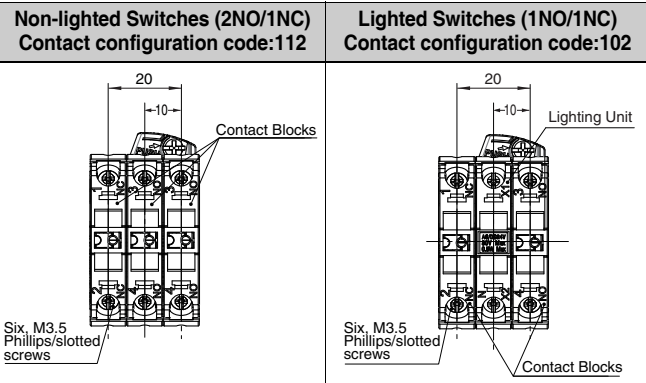

#### BOTTOM VIEW (Push-In Plus terminal block type)

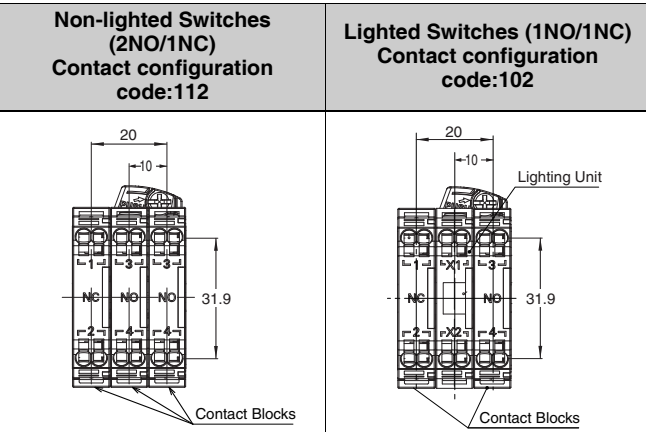

#### Double-contact unit Non-lighted (2NO/2NO/2NC)

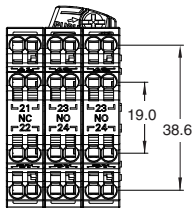

### Terminal Connection Diagrams

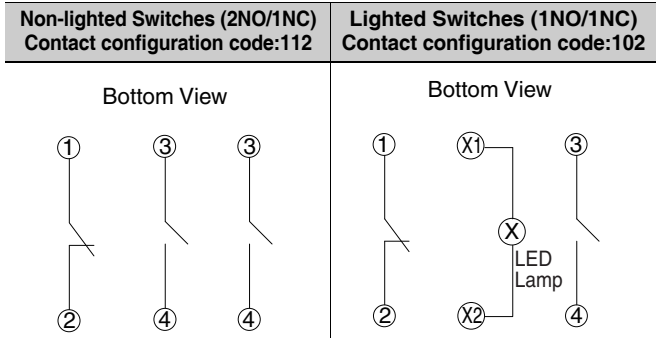

**Note:** The above shows a terminal connection diagram for a screw terminal block type.

Pushbutton Switches  
A22N

Selector Switches  
A22N

Key-type Selector Switches  
A22N

Indicators  
M22N

Pushbutton Switches  
A30N

Selector Switches  
A30N

Key-type Selector Switches  
A30N

Subassemblies (Common)

Accessories and Tools

Safety Precautions

# Key-type Selector Switches A30NK

**30-mm dia. Key-type Selector Switches**  
Control panel miniaturization through a more compact design and modified wiring direction.  
Addition of Push-In Plus terminal blocks for easy wiring.

**Workability and safety improvements.**

### Easy to Use

- You can connect up to three Contact Blocks in one stage for multistage expansion. (Screw terminal block type)
- Screw terminal structure is compatible with round crimp terminals. (Screw terminal block type)
- The terminals can be secured even when a contact block is mounted. (Screw terminal block type)
- Contact Blocks can be attached in any direction for easy assembly.

### Safety

- Easy-to-operate lock lever for secure locking.
- Easy-mounting Contact Blocks provide finger protection.
- No loose connections of wiring means maintenance-free use. (Push-In Plus terminal block type)



### Product Lineup

- The buttons and bezels come in a wide variety of colors and shapes.



**!** Refer to *Safety Precautions for All Pushbutton Switches/Indicators* and *Safety Precautions* on page 88.

## List of Models

Screw Terminal Blocks/Push-In Plus Terminal Blocks	
Brushed metal bezels	
A30NK	
Two Positions	Three Positions
	

- Specifications: Refer to page 60.
- Dimensions: Refer to page 80.
- Accessories and tools: Refer to pages 84 to 85.
- Characteristics: Refer to page 79.
- Subassemblies (Common): Refer to page 82.
- Precautions for correct use: Refer to pages 88 to 99.

Pushbutton Switches  
A22N  
Selector Switches  
A22N  
Key-type Selector Switches  
A22N  
Indicators  
M22N  
Pushbutton Switches  
A30N  
Selector Switches  
A30N  
Key-type Selector Switches  
A30N  
Subassemblies (Common)  
Accessories and Tools  
Safety Precautions

# Model Number Structure

## Model Number Legend

----- Shipped as a set that includes the Operation Unit, Mounting Collar, and Contact Block.  
For information on combinations, refer to *Ordering Information* on page 76.

### Model Numbers for Sets

A 30 N <sup>(1)</sup> **K** - <sup>(2)</sup> **2M** <sup>(3)</sup> **M** - <sup>(4)</sup> **01** <sup>(5)</sup> **A** <sup>(6)</sup> **A** - <sup>(7)</sup> **G** <sup>(8)</sup> **100**

#### (1) Type

Code	Type
K	Key-type Selector Switch

#### (4) Key Number

Code	No.
01	No.1

#### (2) Number of Positions and Bezel Material

Code	No. of positions	Bezel material
2M	2	Brushed metal
3M	3	Brushed metal

#### (5) Key Release Position

Code	Release position	Two positions		Three positions	
		Diagram	Diagram	Diagram	Diagram
A	All positions				
B	Left				
C	Right				
D	Center	---			
G	Left and right	---			

○: Release position      ●: Locked position  
\* The key can only be removed when in the free position for automatic reset models.

#### (3) Reset Method

Code	Reset method		
M	Manual	Two-positions manual	
		Three-positions manual	
L	Automatic reset on left	Two-positions automatic	
		Three-positions left automatic	
R	Automatic reset on right	Three-positions right automatic	
B	Automatic reset on left and right	Three-positions left or right automatic	

#### (6) Degree of Protection

Code	Protection
A	Conforming to IP66, NEMA13

#### (7) Contacts and Terminals Specifications

Code	Specification
G	General/Screw Terminal Block
P	General/Push-In Plus Terminal Block

#### (8) Contact Configuration

Code	Contact Blocks		Unit position			Two positions	Three positions
	NO	NC	1	2	3		
100	1	0	NO	---	---	Yes	---
002	0	1	---	---	NC	Yes	---
101	2	0	NO	---	NO	Yes	Yes
102	1	1	NO	---	NC	Yes	Yes
201	1	1	NC	---	NO	---	Yes
202	0	2	NC	---	NC	Yes	Yes
110	2	0	NO	NO	---	---	Yes
111	3	0	NO	NO	NO	Yes	Yes
112	2	1	NO	NO	NC	Yes	Yes
210	1	1	NC	NO	---	---	Yes
211	2	1	NC	NO	NO	---	Yes
212	1	2	NC	NO	NC	---	Yes
011	2	0	---	NO	NO	---	Yes
012	1	1	---	NO	NC	---	Yes
120	1	1	NO	NC	---	---	Yes
121	2	1	NO	NC	NO	---	Yes
122	1	2	NO	NC	NC	Yes	Yes
220	0	2	NC	NC	---	---	Yes
221	1	2	NC	NC	NO	---	Yes
222	0	3	NC	NC	NC	Yes	Yes
021	1	1	---	NC	NO	---	Yes
022	0	2	---	NC	NC	---	Yes

**Note:** 1. NO (blue): Normally open, NC (orange): Normally closed.  
2. Refer to the following figure for Unit positions.

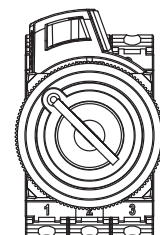

### Operation Angle

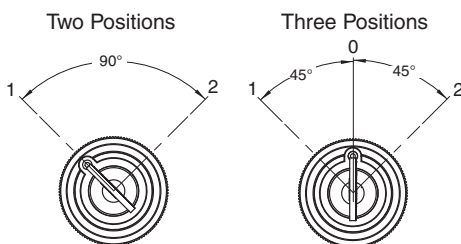

- Specifications: Refer to page 60.
- Dimensions: Refer to page 80.
- Accessories and tools: Refer to pages 84 to 85.

- Characteristics: Refer to page 79.
- Subassemblies (Common): Refer to page 82.
- Precautions for correct use: Refer to pages 88 to 99.

Pushbutton Switches A22N  
 Selector Switches A22N  
 Key-type Selector Switches A22N  
 Indicators M22N  
 Pushbutton Switches A30N  
 Selector Switches A30N  
 Key-type Selector Switches A30N  
 Subassemblies (Common)  
 Accessories and Tools  
 Safety Precautions

# A30NK

## Ordering Information

**Model Numbers for Sets** --- Shipped as a set that includes the Operation Unit, Mounting Collar, and Contact Block.

### Two-position, Key-type Selector Switches

Appearance	Bezel material	No. of outputs	Model	(3) Reset method	(5) Key release positions	(8)(8)(8) Contact configuration
Brushed metal bezels 	2M	1	A30NK-2M(3)-01(5)A-G(8)(8)(8)	M:Manual L:Automatic reset on left	A: All positions B: Left C: Right	100
			A30NK-2M(3)-01(5)A-P(8)(8)(8)			002
		2	A30NK-2M(3)-01(5)A-G(8)(8)(8)			102
			A30NK-2M(3)-01(5)A-P(8)(8)(8)			101
		3	A30NK-2M(3)-01(5)A-G(8)(8)(8)			202
			A30NK-2M(3)-01(5)A-P(8)(8)(8)			111
		222				
		122				
		112				

### Three-position, Key-type Selector Switches

Appearance	Bezel material	No. of outputs	Model	(3) Reset method	(5) Key release positions	(8)(8)(8) Contact configuration
Brushed metal bezels 	3M	2	A30NK-3M(3)-01(5)A-G(8)(8)(8)	M: Manual L: Automatic reset on left R: Automatic reset on right B: Automatic reset on left and right	A: All positions B: Left C: Right D: Center G: Left and right	110
			011			
			101			
			220			
		3	A30NK-3M(3)-01(5)A-P(8)(8)(8)			202
			A30NK-3M(3)-01(5)A-G(8)(8)(8)			120
			A30NK-3M(3)-01(5)A-G(8)(8)(8)			102
			A30NK-3M(3)-01(5)A-P(8)(8)(8)			210
		201				
		012				
		021				
		111				
		222				
		122				
		212				
		221				
		211				
		121				
		112				

Pushbutton Switches A22N  
 Selector Switches A22N  
 Key-type Selector Switches A22N  
 Indicators M22N  
 Pushbutton Switches A30N  
 Selector Switches A30N  
 Key-type Selector Switches A30N  
 Subassemblies (Common)  
 Accessories and Tools  
 Safety Precautions

# Ordering Information

**Subassemblies** - - - - Order Operation Units, Mounting Collars, and Contact Blocks individually. The same Mounting Collars and Contact Blocks are also used for the A22N Series.

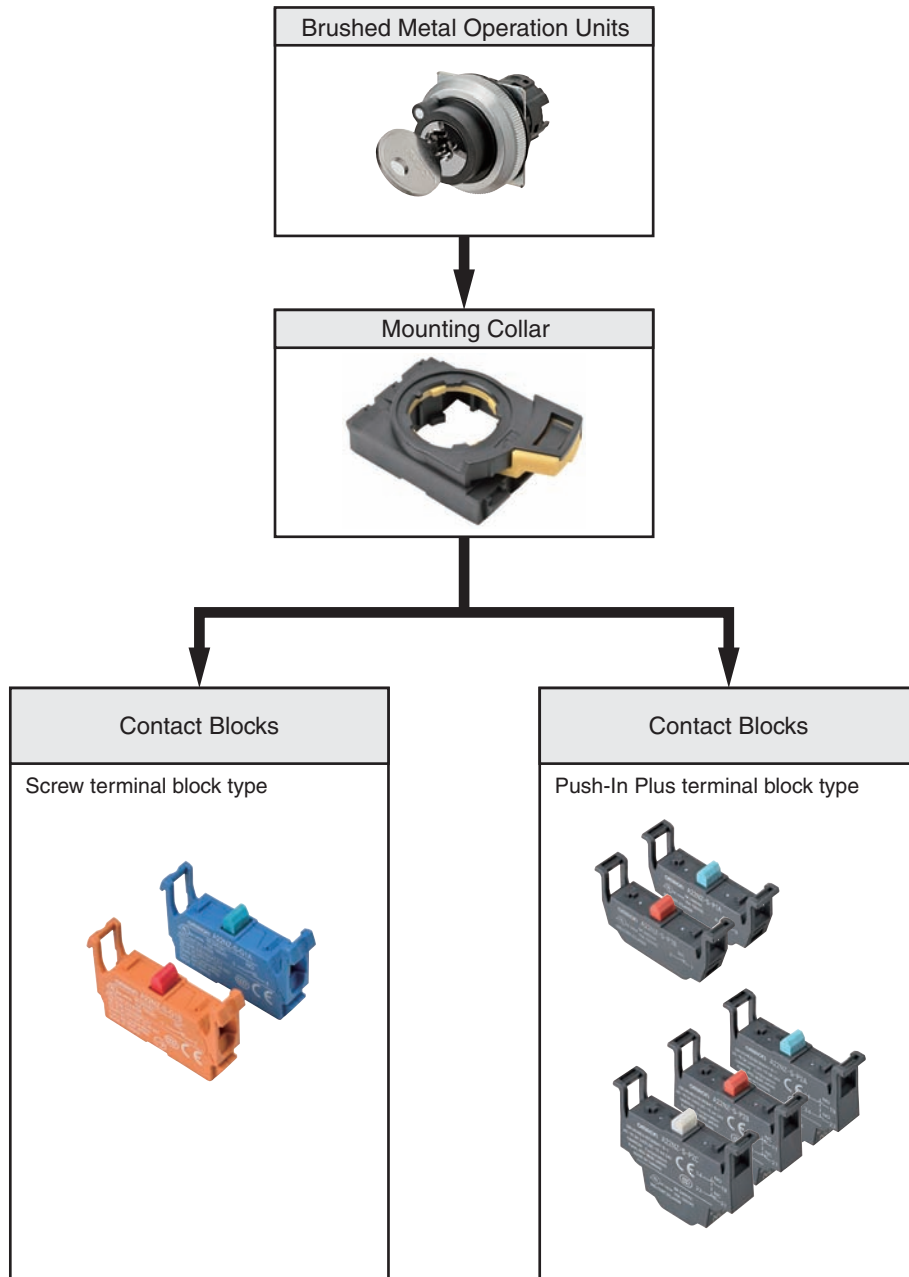

- Specifications: Refer to page 60.
- Dimensions: Refer to page 80.
- Accessories and tools: Refer to pages 84 to 85.
- Characteristics: Refer to page 79.
- Subassemblies (Common): Refer to page 82.
- Precautions for correct use: Refer to pages 88 to 99.

Pushbutton Switches A22N
Selector Switches A22N
Key-type Selector Switches A22N
Indicators M22N
Pushbutton Switches A30N
Selector Switches A30N
Key-type Selector Switches A30N
Subassemblies (Common)
Accessories and Tools
Safety Precautions

# A30NK

**Subassemblies** - - - - Order Operation Units, Mounting Collars, and Contact Blocks individually. The same Mounting Collars and Contact Blocks are also used for the A22N Series.

## Operation Units

Bezel material and shape		Brushed metal	(5) Key release positions
No. of positions	Reset method	Model	
2	Manual	A30NZ-2MM-01(5)A	A: All positions B: Left C: Right
	Automatic reset on left	A30NZ-2ML-01(5)A	
3	Manual	A30NZ-3MM-01(5)A	A: All positions B: Left C: Right D: Center G: Left and right
	Automatic reset on left	A30NZ-3ML-01(5)A	
	Automatic reset on right	A30NZ-3MR-01(5)A	
	Automatic reset on left and right	A30NZ-3MB-01(5)A	

## Specifications

### Certified Safety Standard Ratings

**UL 508 (File No. E76675), CSA C22.2 No.14**

6 A 240 VAC, 10 A 120 VAC

**TÜV (EN60947-5-1)**

AC-15 3 A 240 VAC

DC-13 4 A 24 VDC

**CCC (GB14048.5)**

AC-15 3 A 240 VAC

DC-13 4 A 24 VDC

### Application Standards

UL1059 and UL486E (Push-In Plus terminal block type)

### Ratings

#### Contacts (Standard Load)

Rated insulation voltage		600 V				
Rated carry current		10 A				
Rated voltage		24 V	120 V	240 V	380 V	440 V
AC at 50/60 Hz	Resistive load (AC-12)	10 A	10 A	6 A	2A	2 A
	Inductive load (AC-15)	10 A	6 A	3 A	1.9 A	1.6 A
DC	Resistive load (DC-12)	8 A	2.2 A	1.1 A	---	---
	Inductive load (DC-13)	4 A	1.1 A	0.55 A	---	---

**Note:** 1. The above ratings were obtained by conducting tests under the following conditions.

(1) Ambient temperature: 20 ±2°C

(2) Ambient humidity: 65% ±5% RH

(3) Operating frequency: 30 operations/minute

2. Minimum applicable load: 10 mA at 5 VDC.

## Specifications (When Operation Unit, Mounting Collar, and Contact Blocks Are Combined)

### Characteristics

Item	Type	Key-type Selector Switches	
		Manual reset	Automatic reset
Allowable operating frequency	Mechanical	30 operations/minute max.	
	Electrical	30 operations/minute max.	
Insulation resistance		100 MΩ min. (at 500 VDC)	
Contact resistance		100 mΩ max. (initial value)	
Dielectric strength	Between terminals of same polarity	2,500 VAC at 50/60 Hz for 1 min. (initial value)	
	Between each terminal and ground	2,500 VAC at 50/60 Hz for 1 min. (initial value)	
Vibration resistance	Malfunction	10 to 55 Hz, 1.5-mm double amplitude (malfunction within 1 ms)	
Shock resistance	Malfunction	1,000 m/s <sup>2</sup> max. (malfunction within 1 ms)	
Durability	Mechanical	500,000 operations min. (Switches with 3 positions: 300,000 operations min.)	
	Electrical	500,000 operations min. (Switches with 3 positions: 300,000 operations min.) (250 VAC, 3 A, with an inductive load having power factor cos θ = 0.4)	
Ambient operating temperature <sup>*1</sup>		-25 to 70°C	
Ambient operating humidity		35% to 85% RH	
Ambient storage temperature <sup>*1</sup>		-40 to 80°C	
Degree of protection <sup>*2</sup>		Conforming to IP66	
Electric shock protection class		Class II	
PTI (tracking characteristic)		175	
Degree of contamination (application environment)		3 (EN 60947-5-1)	
Weight		Approx. 75 g (for 1NC/1NO)	

\*1. With no icing or condensation.

\*2. Degree of protection from the front of the panel.

### Operating Characteristics (for SPST-NO/SPST-NC)

Item	Type	Key-type Selector Switches	
		Manual reset	Automatic reset
Total travel force (torque) (maximum TTF)		0.6 N·m	0.6 N·m
Total travel (TT)		2 positions: Approx. 90°, 3 positions: Approx. 45°	
Resetting force (torque) (RF)		0.5 N·m max.	---

### Examples of Linked Contact Blocks (Screw terminal block type)

Contact Blocks

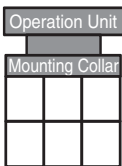
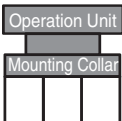
	Key-type Selector Switches	
	2 positions	3 positions
Linking example		

**Note:** If you increase the number of Contact Blocks, evaluate the Switch under actual working conditions before permanent installation and use the Switch within a number of switching operations that will not adversely affect the Switch's performance.

# A30NK

## Dimensions

(Unit: mm)

### Key-type Selection Switches

#### Two-position Switches with Brushed Metal Bezels

A30NK-2M□-01□A-G□

A30NK-2M□-01□A-P□

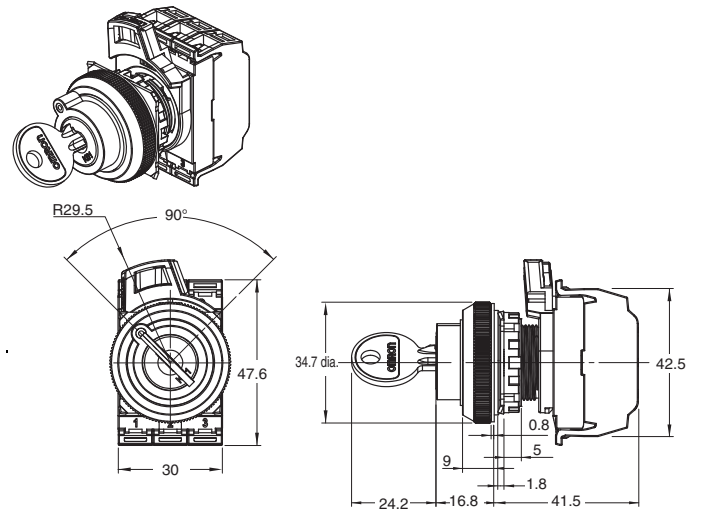
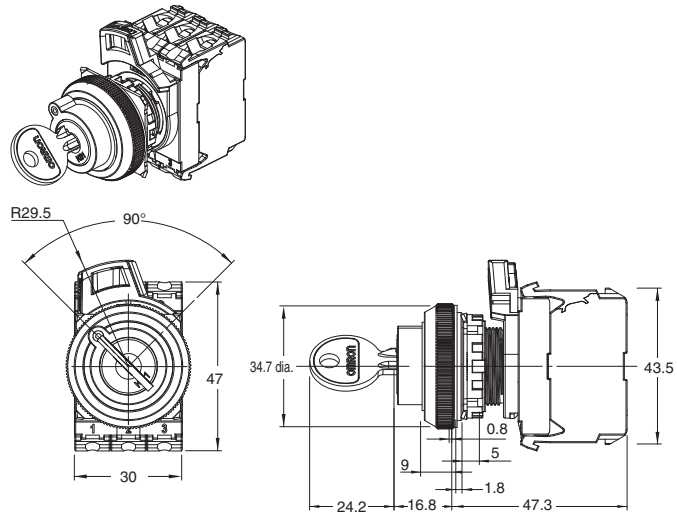

#### Three-position Switches with Brushed Metal Bezels

A30NK-3M□-01□A-G□

A30NK-3M□-01□A-P□

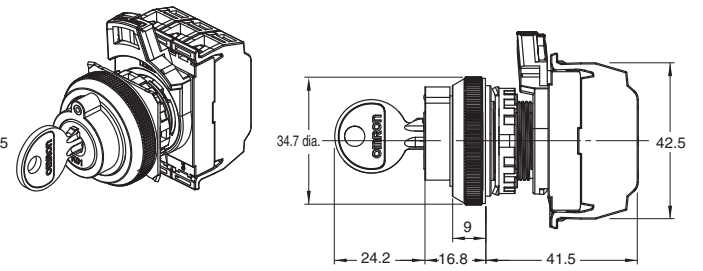
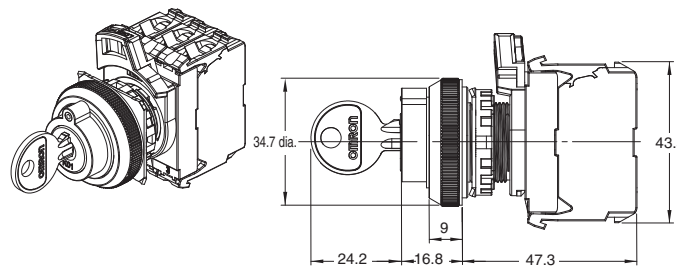

#### Depth with Linked Units (Screw terminal block type)

#### Depth when a double-contact unit is mounted (Push-In Plus terminal block type)

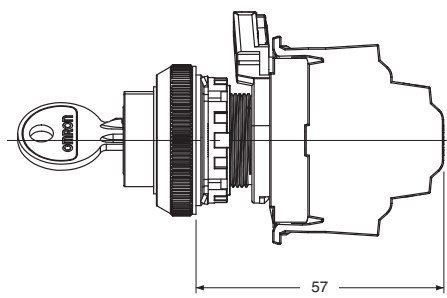
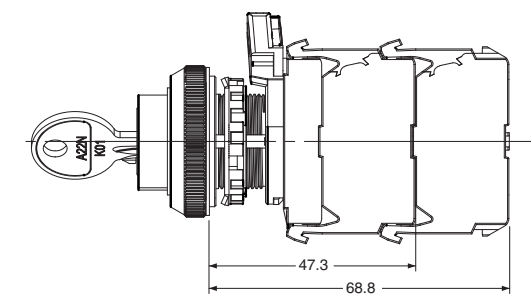

Pushbutton Switches  
A22N  
Selector Switches  
A22N  
Key-type Selector Switches  
A22N  
Indicators  
M22N  
Pushbutton Switches  
A30N  
Selector Switches  
A30N  
Key-type Selector Switches  
A30N  
Subassemblies  
(Common)  
Accessories  
and Tools  
Safety  
Precautions



### Terminal Arrangement BOTTOM VIEW (Screw terminal block type)

**2NO/1NC**  
Contact configuration code:112

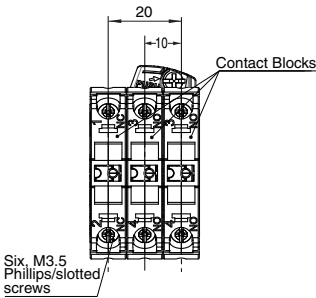

### Terminal Connection Diagrams

**2NO/1NC**  
Contact configuration code:112

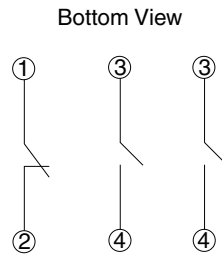

**Note:** The above shows a terminal connection diagram for a screw terminal block type.

### BOTTOM VIEW (Push-In Plus terminal block type)

**2NO/1NC**      **Double-contact unit**  
Contact configuration code:112      **(2NO/2NO/2NC)**

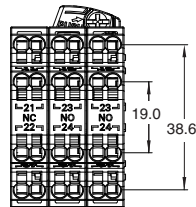
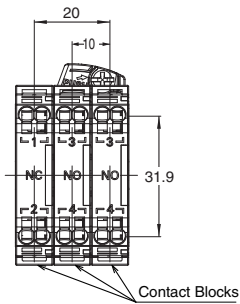

Pushbutton Switches  
A22N

Selector Switches  
A22N

Key-type Selector Switches  
A22N

Indicators  
M22N

Pushbutton Switches  
A30N

Selector Switches  
A30N

Key-type Selector Switches  
A30N

Subassemblies  
(Common)

Accessories  
and Tools

Safety  
Precautions

# A22N/M22N/A30N

## Subassemblies (Common)

## Ordering Information

**Subassemblies** --- You can order Operation Units, LED Lamps, Mounting Collars, and Contact Blocks individually. Use them in combination for models that are not available as assembled Units. These can also be used as inventory for maintenance parts.



### LED Lamps

Appearance	Rated voltage	Model				
	Color	6 VAC/DC	12 VAC/DC	24 VAC/DC	100/110/120 VAC	200/220/230/240 VAC
	Red	A22NZ-L-RA	A22NZ-L-RB	A22NZ-L-RC	A22NZ-L-RD	A22NZ-L-RE
	Green	A22NZ-L-GA	A22NZ-L-GB	A22NZ-L-GC	A22NZ-L-GD	A22NZ-L-GE
	Yellow	A22NZ-L-YA	A22NZ-L-YB	A22NZ-L-YC	A22NZ-L-YD	A22NZ-L-YE
	White	A22NZ-L-WA	A22NZ-L-WB	A22NZ-L-WC	A22NZ-L-WD	A22NZ-L-WE
	Blue	A22NZ-L-AA	A22NZ-L-AB	A22NZ-L-AC	A22NZ-L-AD	A22NZ-L-AE
	Orange	A22NZ-L-OA	A22NZ-L-OB	A22NZ-L-OC	A22NZ-L-OD	A22NZ-L-OE



### Mounting Collar

Appearance	Model
	A22NZ-H-01

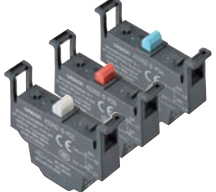
### Contact Blocks

Appearance	Terminals Specifications	Contacts	Model
	Screw terminal block	SPST-NO (blue)	A22NZ-S-G1A
		SPST-NC (orange)	A22NZ-S-G1B
	Push-In Plus terminal block	SPST-NO (blue)	A22NZ-S-P1A
		SPST-NC (red)	A22NZ-S-P1B
	Push-In Plus terminal block	DPST-NO (blue)	A22NZ-S-P2A
		DPST-NC (red)	A22NZ-S-P2B
		SPST-NO/SPST-NC (white)	A22NZ-S-P2C

### Lighting Units

Appearance	Terminals Specifications	Rated voltage	Model
	Screw terminal block	6 VAC/DC	A22NZ-T-A
		12 VAC/DC	A22NZ-T-B
		24 VAC/DC	A22NZ-T-C
		100/110/120 VAC	A22NZ-T-D
		200/220/230/240 VAC	A22NZ-T-E
	Push-In Plus terminal block	6 VAC/DC	A22NZ-T-AP
		12 VAC/DC	A22NZ-T-BP
		24 VAC/DC	A22NZ-T-CP
		100/110/120 VAC	A22NZ-T-DP
		200/220/230/240 VAC	A22NZ-T-EP

**Subassemblies (Common)**

**Dimensions**

(Unit: mm)

**LED Lamps**  
A22NZ-L-□□

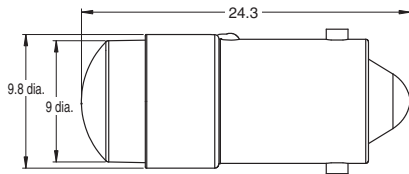
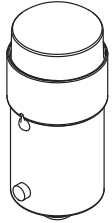

**Mounting Collar**  
A22NZ-H-01

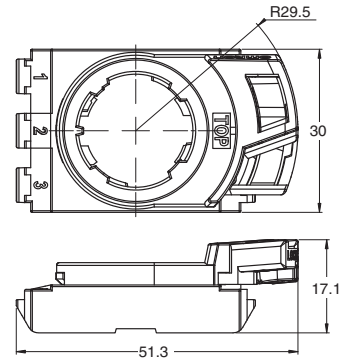
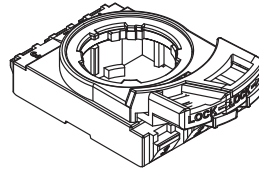

**Screw terminal block**

**Contact Blocks**  
A22NZ-S-G1□

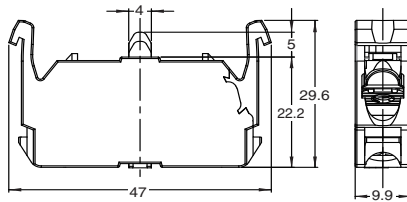
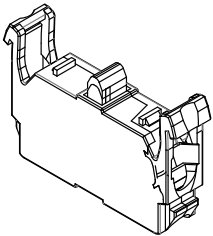

**Lighting Units**  
A22NZ-T-□

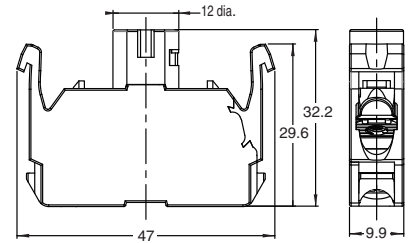
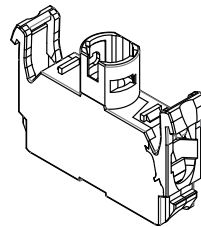

**Push-In Plus Terminal Blocks**

**Contact Blocks (Single Contact)**  
A22NZ-S-P1□

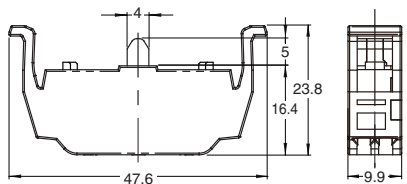
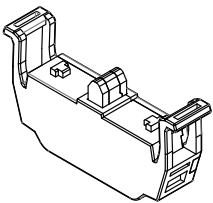

**Contact Blocks (Double Contact)**  
A22NZ-S-P2□

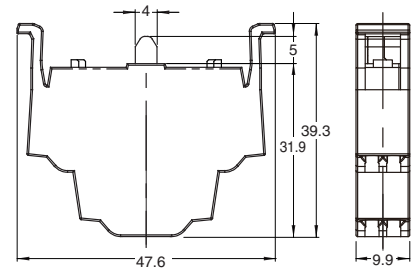
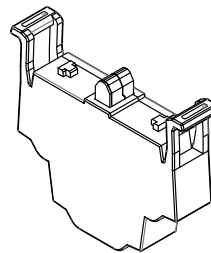

**Lighting Units**  
A22NZ-T-□P

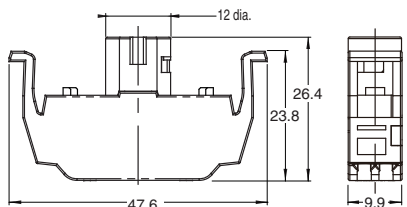
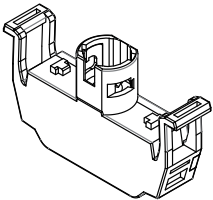

Pushbutton Switches  
A22N

Selector Switches  
A22N

Key-type Selector Switches  
A22N

Indicators  
M22N

Pushbutton Switches  
A30N

Selector Switches  
A30N

Key-type Selector Switches  
A30N

Subassemblies (Common)

Accessories and Tools









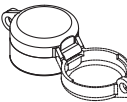

Safety Precautions

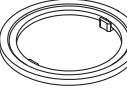
# A22N/M22N/A30N

## Accessories and Tools

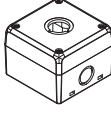



### Ordering Information

#### Accessories and Tools (Order Separately)

Item	Appearance	Classification		Model	Remarks
Protective Cover		---		<b>A22NZ-A-303</b>	A protector designed to prevent incorrect operation. Cannot be used together with other accessories. (Rubber seal included.) For 22.3 and 25.5-mm panel holes diameter. Key-type selector switches cannot be used.
Plastic Hole Plug		Round		<b>A22NZ-A-401</b>	Can be plugged into precut panel holes for future expansion. Applicable panel thickness: 0.8 to 3.0 mm For 22.3-mm panel hole diameter.
Metal Hole Plug		Round		<b>A22NZ-A-402</b>	Can be plugged into precut panel holes for future expansion. Applicable panel thickness: 0.8 to 6.0 mm (Rubber seal included.) For 22.3-mm panel hole diameter.
Lock Ring		Round		<b>A22NZ-A-403</b>	Used when a more secure lock is required to prevent rotation inside the Operation Unit. (Rubber seal included.) For 22.3-mm panel hole diameter. Can be used together with the A22NZ-A-50501 Lock Ring.
Lock Ring		---		<b>A22NZ-A-50501</b>	Used when a more secure lock is required to prevent rotation of the Operation Unit. Can be used together with the A22NZ-A-403 Lock Ring.
Reinforcement Plate		---		<b>A22NZ-A-C01</b>	Used to reinforce Contact Blocks and Lighting Units. Refer to page 95 for mounting instructions.
Key		---		<b>A22NZ-K-01</b>	Used with a key-type selector switch.
Control Box		1 hole		<b>A22NZ-A-B01Y</b>	Applicable Range <ul style="list-style-type: none"> <li>Type with Screw Terminal Block One Switch can be linked.</li> <li>Type with Push-in Plus Terminal Block Compatible only with Switches with a Single-contact Unit.</li> </ul> For 22.3-mm panel hole diameter.
Connector		Suitable Cable Diameter (mm)	7 to 9 dia.	<b>A22Z-3500-1</b>	Plastic connector used to extend a cable from the switch box. Refer to page 98 for details.
			9 to 11 dia.	<b>A22Z-3500-2</b>	
Sealing Caps		For flat models		<b>A22Z-3600F</b>	Used to prevent dust or water from entering the Operation Unit. Color: opaque Material: silicon For 22.3 and 25.5-mm panel holes diameter. Knob-type and key-type selector switches cannot be used.
		For projection models		<b>A22Z-3600T</b>	
		For full-guard models		<b>A22Z-3600G</b>	
Resin Attachment for 30 dia.		Round		<b>A22Z-A30</b>	Use when mounting to a panel with a 30-dia. hole. Refer to page 99 for details. Purchase and mount a separate Lock Ring when using an indicator.

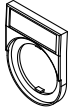
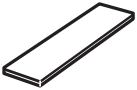
**Accessories and Tools**

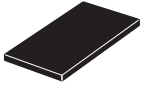
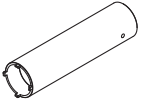
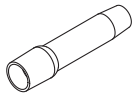
**Ordering Information**

Item	Appearance	Classification	Model	Remarks
Small Legend Plate Frame		Black	<b>A22NZ-A-50103</b>	Legend Plate with no text on black background included. For 22.3-mm panel hole diameter.
Small Legend Plates (Standard Size)		Without text	<b>A22Z-3443B</b>	Black
			<b>A22Z-3443R</b>	Red
			<b>A22Z-3443W</b>	White
			<b>A22Z-3443C</b>	Transparent
		○	<b>A22Z-3443R-2</b>	White text on red background
		STOP	<b>A22Z-3443R-4</b>	
			<b>A22Z-3443B-1</b>	White text on black background
		START	<b>A22Z-3443B-3</b>	
		ON	<b>A22Z-3443B-5</b>	
		OFF	<b>A22Z-3443B-6</b>	
		UP	<b>A22Z-3443B-7</b>	
		DOWN	<b>A22Z-3443B-8</b>	
POWER ON	<b>A22Z-3443B-9</b>			
OFF-ON	<b>A22Z-3443B-10</b>			
Large Legend Plate Frame		Black	<b>A22NZ-A-51103</b>	Legend Plate with no text on black background included. For 22.3-mm panel hole diameter.
Large Legend Plates		Without text	<b>A22Z-3453B</b>	Black
			<b>A22Z-3453R</b>	Red
			<b>A22Z-3453W</b>	White
			<b>A22Z-3453C</b>	Transparent
Tightening Wrench		---	<b>A22NZ-A-301</b>	Used to tighten Mounting Nuts from the back of the panel.
LED Lamp Extractor		---	<b>A22NZ-A-302</b>	Made of rubber and used to easily remove and attach LED Lamps.
Cap Tightening Wrench		---	<b>A22Z-3908</b>	Used to replace the Caps on Flat, Projected, and Full-guard Pushbutton Switches.

Pushbutton Switches  
A22N

Selector Switches  
A22N

Key-type Selector Switches  
A22N

Indicators  
M22N

Pushbutton Switches  
A30N

Selector Switches  
A30N

Key-type Selector Switches  
A30N

Subassemblies (Common)

Accessories and Tools

Safety Precautions

# A22N/M22N/A30N

## Accessories and Tools

### Dimensions

(Unit: mm)

#### Protective Cover A22NZ-A303

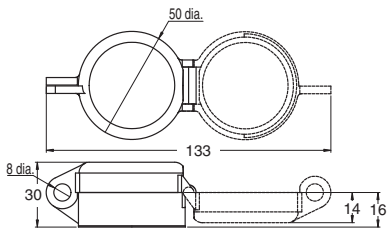
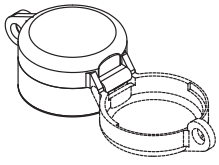

#### Plastic Hole Plug A22NZ-A-401

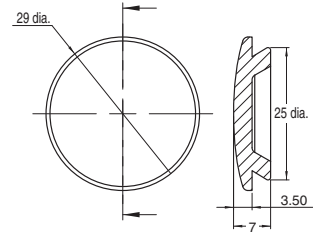
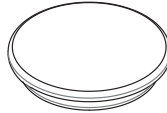

#### Metal Hole Plug A22NZ-A-402

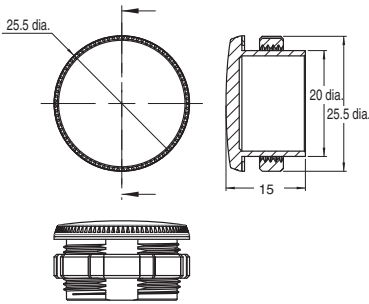
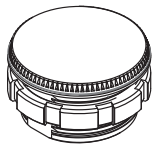

#### Lock Ring A22NZ-A-403

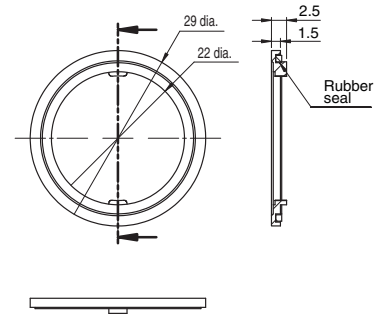
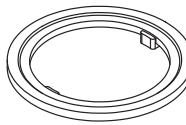

#### Lock Ring A22NZ-A-50501

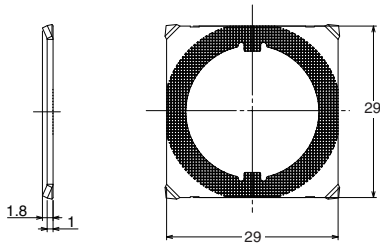
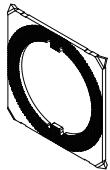

#### Reinforcement Plate A22NZ-A-C01

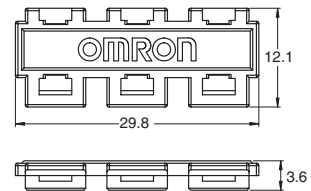
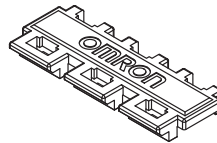

#### Control Box A22NZ-A-B01Y

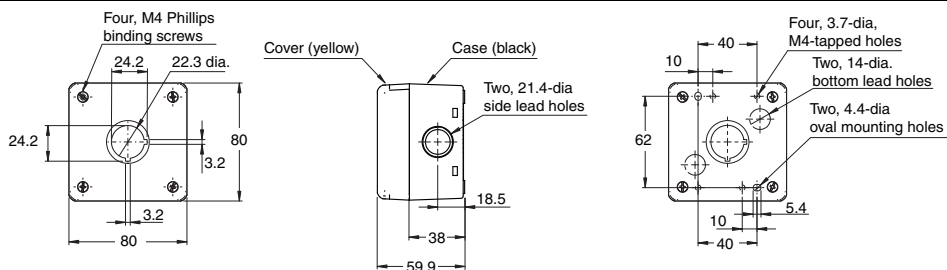
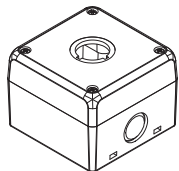

#### Sealing cap

##### For Flat Models A22Z-3600F

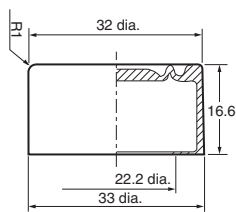
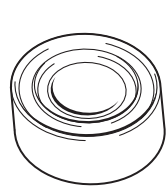

##### For projection models A22Z-3600T

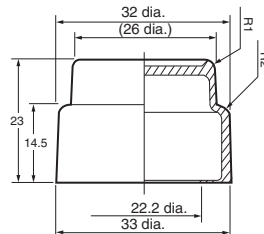

##### For full-guard models A22Z-3600G

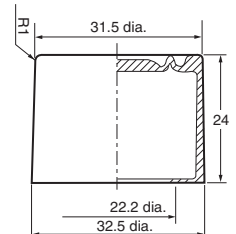

#### Resin Attachment for 30 dia. A22Z-A30

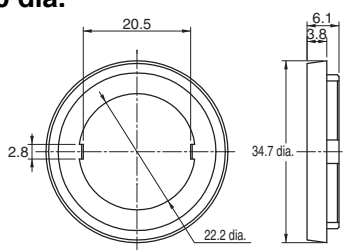

Accessories and Tools

Dimensions

(Unit: mm)

Legend Plate Frames  
General A22NZ-A-50103

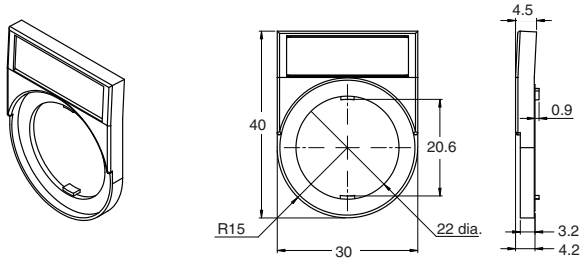

Large A22NZ-A-51103

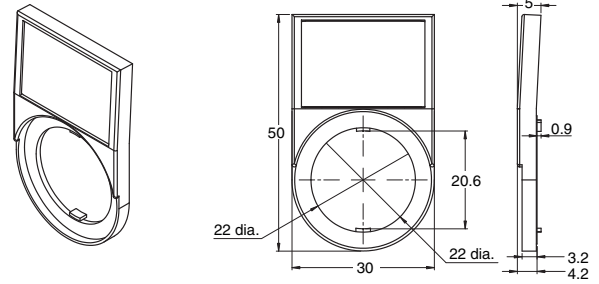

Legend Plates  
General A22Z-3443□-□

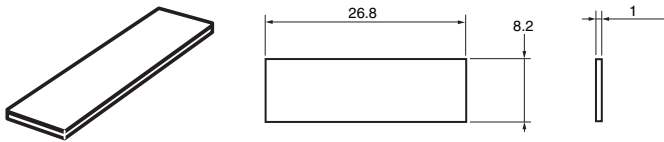

Large A22Z-3453□

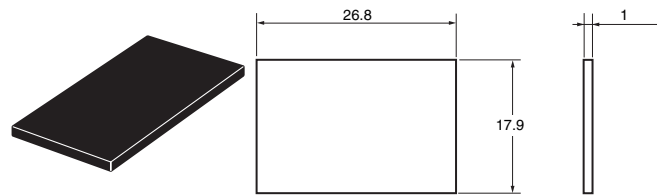

Tightening Wrench  
A22NZ-A-301

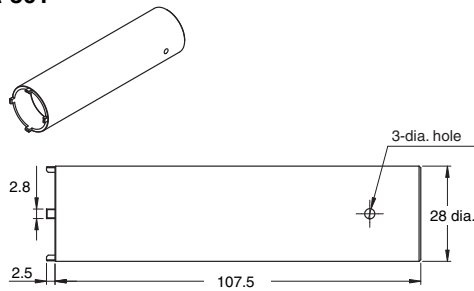

LED Lamp Extractor  
A22NZ-A-302

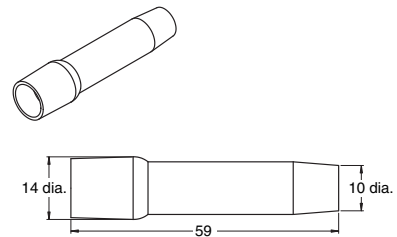

Cap Tightening Wrench  
A22Z-3908

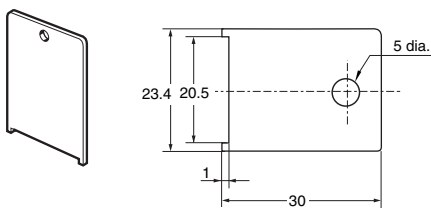

Pushbutton Switches  
A22N

Selector Switches  
A22N

Key-type Selector Switches  
A22N

Indicators  
M22N

Pushbutton Switches  
A30N

Selector Switches  
A30N

Key-type Selector Switches  
A30N

Subassemblies  
(Common)

Accessories  
and Tools

Safety  
Precautions

# A22N/M22N/A30N

## Safety Precautions

Refer to Safety Precautions for All Pushbutton Switches/Indicators.

### Signal Word Definitions

<b>Precautions for Safe Use</b>	Supplementary comments on what to do or avoid doing, to use the product safely.
<b>Precautions for Correct Use</b>	Supplementary comments on what to do or avoid doing, to prevent failure to operate, malfunction, or undesirable effects on product performance.

### Precautions for Safe Use

#### For both the Screw terminal block type and the Push-In Plus terminal block type

- Do not perform wiring with power supplied to the Switch/Indicator. Do not touch the terminals or other charged parts while power is being supplied. Doing so may result in electric shock.
- Do not disassemble or modify the Switch/Indicator under any circumstances.
- Doing so may prevent the Switch/Indicator from functioning to its full capability. Do not drop the Switch/Indicator. Do not apply pressure that may deform or alter the Switch/Indicator.
- The durability of the Switch varies considerably depending on the switching conditions. Always test the Switch/Indicator under actual working conditions before application and use the Switch/Indicator only for the number of switching operations allowed.
- Do not allow the load voltage and current to exceed the rated value. This may damage or burn out the Switch/Indicator.
- Do not use the Switch/Indicator in locations where explosive or flammable gases or liquid may be present or scattered. The electric arc or the heat caused by switching contacts may cause a fire or explosion.
- Do not use the Switch/Indicator in locations where toxic gases, such as H<sub>2</sub>S, SO<sub>2</sub>, NH<sub>3</sub>, HNO<sub>3</sub>, and Cl<sub>2</sub>, may be present, or in locations subject to high temperature or humidity. Doing so may damage the Switch/Indicator due to contact failure or corrosion.
- Do not use the Switch/Indicator submersed in oil or water, or in locations continuously subject to splashes of oil or water. Doing so may result in oil or water entering and damaging the Switch/Indicator.
- Do not use or keep the Switch/Indicator under the following conditions:
  - Subject to severe temperature changes.
  - Subject to high humidity or condensation.
  - Subject to severe vibration or shock.
  - Where direct rays of the sun strike.
  - Where sea breeze may be present.
- Make sure that a rubber washer is present between the Operation Unit and the panel. Otherwise, the specifications of the protective structure may not be satisfied.
- Do not apply excessive force to the Switch or wiring. A damaged or deformed contact block may cause contact failure.
- Use an appropriate wire and ferrule.
- Exercise caution to avoid wiring errors when connecting the terminals.

- To prevent wiring materials from smoking or igniting, confirm wire ratings and use the wiring materials given in the following table.

Model	Wire Type	Wire	Recommended Wires	Stripped length
A22N, M22N (Screw terminal block)	Solid wire/ stranded wire	Copper	1.25 to 2.5 mm <sup>2</sup> / AWG 16 to 14	8 mm
A22N-P, M22N-P (Push-In Plus terminal block)			0.25 to 1.5 mm <sup>2</sup> / AWG 24 to 16	Ferrules not used : 8 mm

Use wiring crimp terminals and ferrule terminals of the specified size.

- For Push-In Plus terminal blocks, use only one wire per terminal. For screw terminal blocks, use no more than two wires of the same size and type with no more than two crimp terminals per terminal.
- After storing the product for a long time exceeding 1 year, perform, at a minimum, inspections of the operating characteristics, contact resistance, insulation resistance, and dielectric strength as well as evaluate the product under the working conditions.
- This Switch/Indicator is intended for indoor use only. Using the Switch/Indicator outdoors may result in failure.

#### Push-In Plus Terminal Blocks

- Do not wire anything to the release holes.
- Do not tilt or twist a flat-blade screwdriver while it is inserted into a release hole on the terminal block. The terminal block may be damaged.
- Insert a flat-blade screwdriver into the release holes at an angle. The terminal block may be damaged if you insert the screwdriver straight in.
- Do not allow the flat-blade screwdriver to fall out while it is inserted into a release hole.
- Do not bend a wire past its natural bending radius or pull on it with excessive force. Doing so may cause the wire disconnection.
- Do not insert more than one wire into each terminal insertion hole.
- Do not mount A22N-P Push-In Plus terminal contact blocks on A22N screw terminal blocks. Doing so may result in unsatisfactory performance.



## Precautions for Correct Use

### Mounting

- Do not tighten the Mounting Nut more than necessary using tools such as pointed-nose pliers. Doing so will damage the Mounting Nut. (The tightening torque of the Mounting Nut is 1.0 to 2.0 N·m.)

### Wiring (Screw terminal block)

- Terminal screws must be M3.5 Phillips or slotted screws with a square washer.
- The terminal screw tightening torque is 1.0 to 1.3 N·m.
- Solid wires, stranded wires, and crimp terminals can be connected to the Switch/Indicator.

#### Bare Crimp Terminals

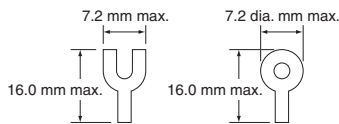

#### Crimp Terminals with Insulating Sheathes

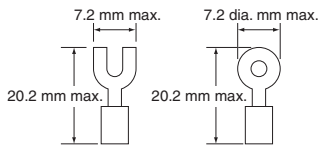

### Wiring (Push-in Plus terminal block)

#### 1. Connecting Wires to the Push-In Plus Terminal Block

##### Part Names of the Terminal Block

##### <A22N>

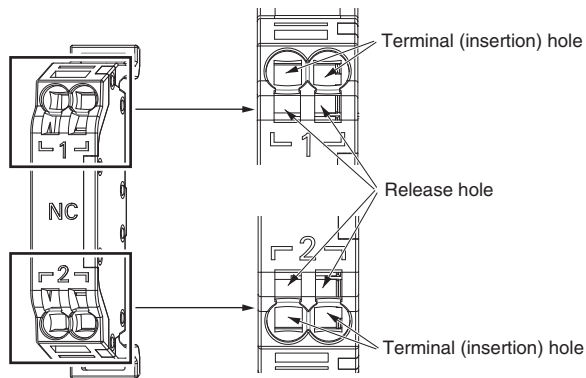

##### <M22N>

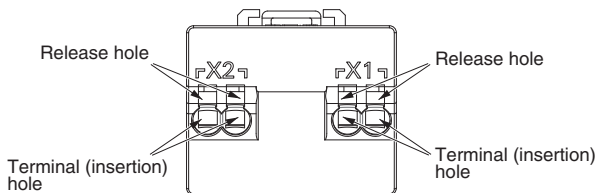

### Connecting Wires with Ferrules and Solid Wires

- Insert the solid wire or ferrule straight into the terminal block until the end strikes the terminal block. The angle should be approximately 6°.
- If a wire is difficult to connect because it is too thin, use a flat-blade screwdriver in the same way as when connecting stranded wires.

##### <A22N>

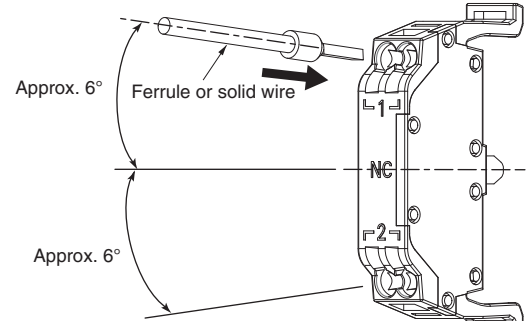

The wiring for the Lighting Unit and Contact Block (2 contacts) are the same as for the Contact Block (1 contact) shown in the above illustration.

##### <M22N>

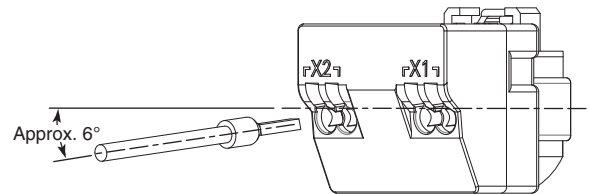

# A22N/M22N/A30N

## Connecting Stranded Wires

Use the following procedure to connect the wires to the terminal block.

1. Hold a flat-blade screwdriver at an angle and insert it into the release hole.
2. With the flat-blade screwdriver still inserted into the release hole, insert the wire into the terminal hole until the end strikes the terminal block.
3. Remove the flat-blade screwdriver from the release hole.

### <A22N>

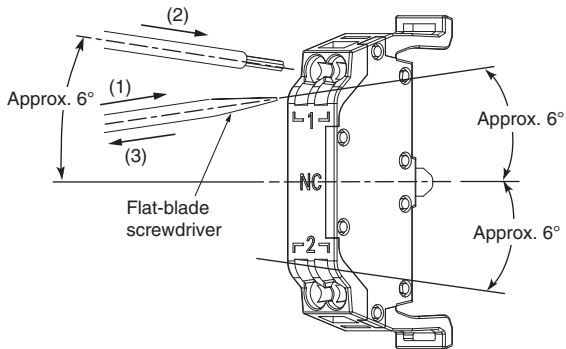

The wiring and screwdriver angles for the Lighting Unit and Contact Block (2 contacts) are the same as for the Contact Block (1 contact) shown in the above illustration.

### <M22N>

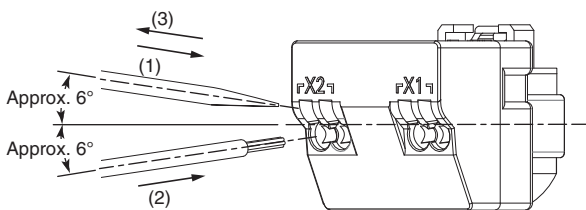

## Checking Connections

- After the insertion, pull gently on the wire to make sure that it will not come off and it is securely fastened to the terminal block.
- If you use a ferrule with a conductor length of 10 mm, part of the conductor may be visible after the ferrule is inserted into the terminal block, but the product insulation distance will still be satisfied.

## 2. Removing Wires from the Push-In Plus Terminal Block

Use the following procedure to remove wires from the terminal block. The same method is used to remove stranded wires, solid wires, and ferrules.

1. Hold a flat-blade screwdriver at an angle and insert it into the release hole. The angle should be approximately 6°.
2. With the flat-blade screwdriver still inserted into the release hole, remove the wire from the terminal insertion hole.
3. Remove the flat-blade screwdriver from the release hole.

### <A22N>

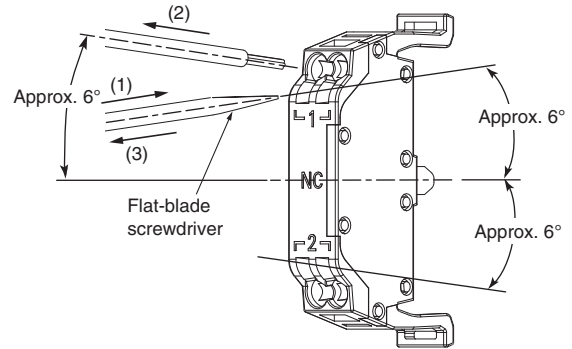

The wiring and screwdriver angles for the Lighting Unit and Contact Block (2 contacts) are the same as for the Contact Block (1 contact) shown in the above illustration.

### <M22N>

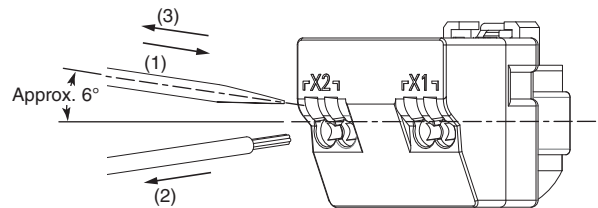

**3. Recommended Ferrules and Crimp Tools**  
**Recommended ferrules**

Applicable wire		Ferrule Conductor Length (mm)	Stripped length (mm) (Ferrules used)	Recommended ferrules		
(mm <sup>2</sup> )	(AWG)			Phoenix Contact product	Weidmuller product	Wago product
0.25	24	8	10	AI 0,25-8	H0.25/12	216-301
		10	12	AI 0,25-10	---	---
0.34	22	8	10	AI 0,34-8	H0.34/12	216-302
		10	12	AI 0,34-10	---	---
0.5	20	8	10	AI 0,5-8	H0.5/14	216-201
		10	12	AI 0,5-10	H0.5/16	216-241
0.75	18	8	10	AI 0,75-8	H0.75/14	216-202
		10	12	AI 0,75-10	H0.75/16	216-242
1/1.25	18/17	8	10	AI 1-8	H1.0/14	216-203
		10	12	AI 1-10	H1.0/16	216-243
1.25/1.5	17/16	8	10	AI 1,5-8	H1.5/14	216-204
		10	12	AI 1,5-10	H1.5/16	216-244
Recommended Crimp Tools				CRIMPFOX6 CRIMPFOX6T-F CRIMPFOX10S	PZ6 roto	Variocrimp4

- Note:**
1. Make sure that the outer diameter of the wire coating is smaller than the inner diameter of the insulation sleeve of the recommended ferrule.
  2. Make sure that the ferrule processing dimensions conform to the following figures.

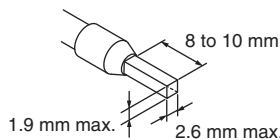

**Recommended Flat-Blade Screwdrivers**

Use a flat-blade screwdriver to connect and remove wires. Use one of the following flat-blade screwdrivers. The following table shows manufacturers and models as of 2015/Dec.

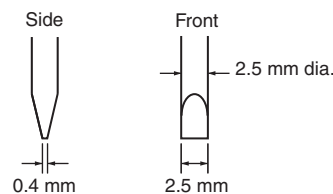

Model	Manufacturer
ESD 0,40 x 2,5	Wera
SZS 0,4 x 2,5 SZF 0-0,4 x 2,5 *	Phoenix Contact
0.4 x 2.5 x 75 302	Wiha
AEF.2,5 x 75	Facom
210-719	Wago
SDI 0.4 x 2.5 x 75	Weidmuller

\* OMRON's exclusive purchase model XW4Z-00B is available to order as SZF 0-0,4 x 2,5 (manufactured by Phoenix Contact).  
 • After wiring the Switch/Indicator, provide a sufficient insulation distance.

The following information applies to both screw terminal blocks and Push-In Plus terminal blocks.

**LED Lamps**

- A current-limiting resistor is built in the LED lamp, so the installation of an external resistance is not required.
- Lighting malfunction of the LED lamp  
 A micro-current of approximately 0.1 mA or less is sufficient to turn on the LED lamps. Take a countermeasure like adding a resistor to prevent mis-lighting in parallel to the LED lamp. The micro-current varies with the machine (leak current or stray capacity between cables, etc.). Select resistance value and allowable power consumption that meet the actual current.

**(Example of lighting malfunction prevention circuit)**  
 When using a 24-VAC/VDC lighted unit

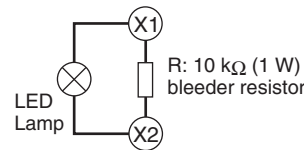

**Key-Type Selector Switches**

- Make sure to insert the key to the bottom of the cylinder before turning it.

**Button Operation**

- Do not rotate or pull on the button on a Mushroom Switch. The button may come off, preventing operation.

Pushbutton Switches  
A22N

Selector Switches  
A22N

Key-Type Selector Switches  
A22N

Indicators  
M22N

Pushbutton Switches  
A30N

Selector Switches  
A30N

Key-Type Selector Switches  
A30N

Subassemblies (Common)

Accessories and Tools

Safety Precautions

## Application

### Mounting to the Panel

#### Panel Hole Dimensions

##### <A22N>

- Panel hole dimensions are given below.
- The recommended panel thicknesses are given below.

Panel hole dimension	Panel thickness
22.3 dia.	0.8 to 5 mm
25.5 dia.	0.8 to 6 mm

- If outer surface treatment such as coating is performed for the panel, the panel dimensions after outer surface treatment must meet the specified panel dimensions.
- The following figure gives pitch dimension A and pitch dimension B between the centers of the mounting holes.

#### Panel Hole Dimensions for 22.3 Diameter

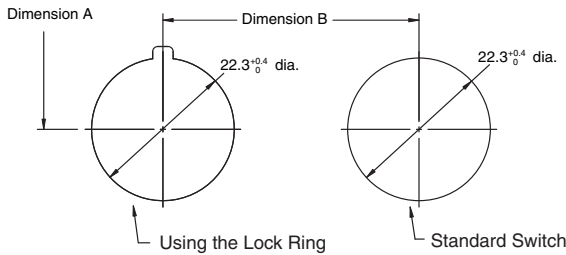
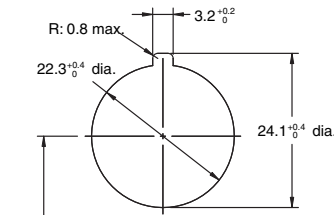

#### Panel Hole Dimensions for 25.5 Diameter

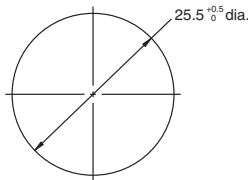

#### Dimension A

Wire type	Number of linked Contact Blocks	Number of wires per terminal	Minimum allowable pitch Dimension A (mm) or larger
Leads (stranded wire / solid wire)	1	1	50
Bare crimp terminals	1	1	50
Crimp terminals with insulating sheaths	1	1	60

**Note:** The minimum mounting pitch is based on three Contact Blocks in stage 1 with one wire attached to each terminal.  
If the Mounting Collar lock levers all face the same direction at the minimum mounting pitch, be sure to note the order the mounting collars are attached to the Operation Unit.  
If you attach two wires or link Units, determine the mounting pitch based on the dimensions diagrams and ease of operation and wiring.

#### Dimension A When Using Accessory

- Dimension A is 50 mm minimum when a Standard Legend Plate Frame is attached.
- Dimension A is 51 mm minimum when a Large Legend Plate Frame is attached.
- Dimension A is 75 mm minimum when a Protective Cover is attached.

#### Dimension B

Operation Unit shape	Dimension B
Mushroom	40 mm min.
Other than the above	30 mm min.

##### <M22N>

- Panel hole dimensions are given below.
- Acceptable panel thickness is between 0.8 and 6 mm.
- If outer surface treatment such as coating is performed for the panel, the panel dimensions after outer surface treatment must meet the specified panel dimensions.

#### Panel Hole Dimensions for 22.3 Diameter

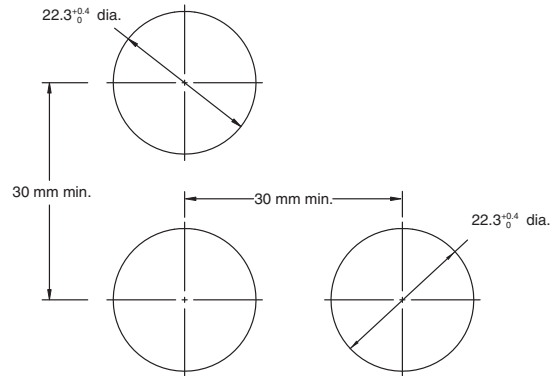

#### Panel Hole Dimensions for 25.5 Diameter

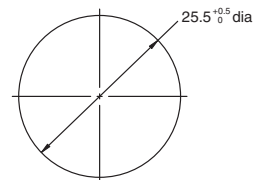

##### <A30N>

- Panel hole dimensions are given below.
- Acceptable panel thickness is between 0.8 and 7 mm.
- If outer surface treatment such as coating is performed for the panel, the panel dimensions after outer surface treatment must meet the specified panel dimensions.
- The following figure gives pitch dimension A and pitch dimension B between the centers of the mounting holes.

#### Panel Hole Dimensions

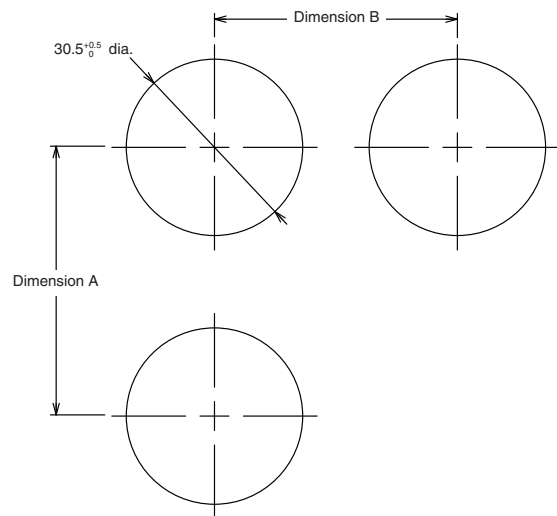

## Dimension A

Wire type	Number of linked Contact Blocks	Number of wires per terminal	Minimum allowable pitch Dimension A (mm) or larger
Leads (stranded wire / solid wire)	1	1	50
Bare crimp terminals	1	1	50
Crimp terminals with insulating sheaths	1	1	60

**Note:** The minimum mounting pitch is based on three Contact Blocks in stage 1 with one wire attached to each terminal. If the Mounting Collar lock levers all face the same direction at the minimum mounting pitch, be sure to note the order the mounting collars are attached to the Operation Unit. If you attach two wires or link Units, determine the mounting pitch based on the dimensions diagrams and ease of operation and wiring.

## Dimension B

Operation Unit shape	Dimension B
Mushroom	40 mm min.
Other than the above	35 mm min.

## Mounting the Operation Unit

### <A22N>

- Panel Hole of 22.3-mm Diameter  
Insert the Operation Unit from the front of the panel, insert the Lock Ring and Mounting Nut from the back of the panel, and tighten the Mounting Nut. Before tightening, check that the rubber washer is present between the Operation Unit and the panel.

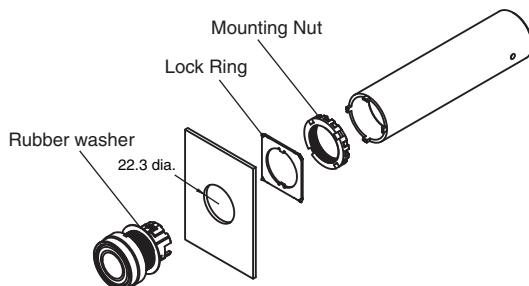

- Panel Hole of 25.5-mm Diameter  
Do not use the Lock Ring, and tighten the Mounting Nut while confirming that the projecting part (see following figure) on the Mounting Nut is aligned with mounting hole. Before tightening, check that the rubber washer is present between the Operation Unit and the panel.

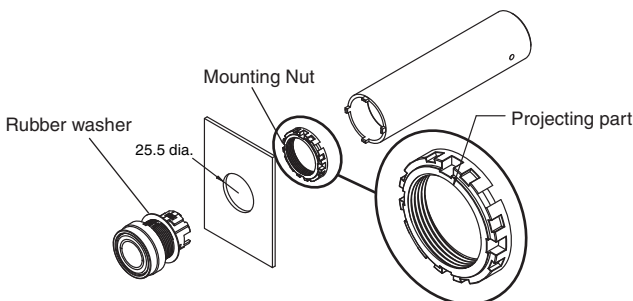

- Align the Lock Ring with the slot on the case and insert it so that the edge is flush with the panel.

### <A30N>

- Insert the Operation Unit from the front of the panel, insert the Lock Ring and Mounting Nut from the back of the panel, and tighten the Mounting Nut. Before tightening, check that the rubber washer is present between the Operation Unit and the panel.

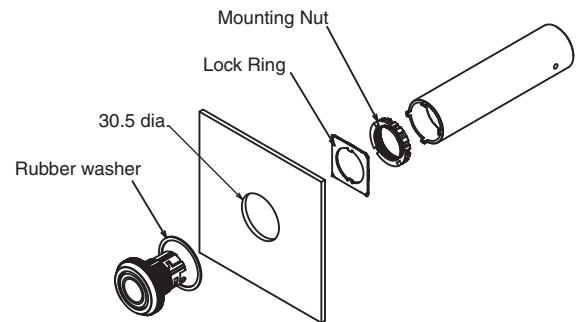

## Mounting the Indicator Unit

### <M22N>

- Panel Hole of 22.3-mm Diameter  
Insert the Indicator Unit from the front of the panel, insert the Mounting Nut from the back of the panel, and tighten the Mounting Nut. Before tightening, check that the rubber washer is present between the Indicator Unit and the panel.

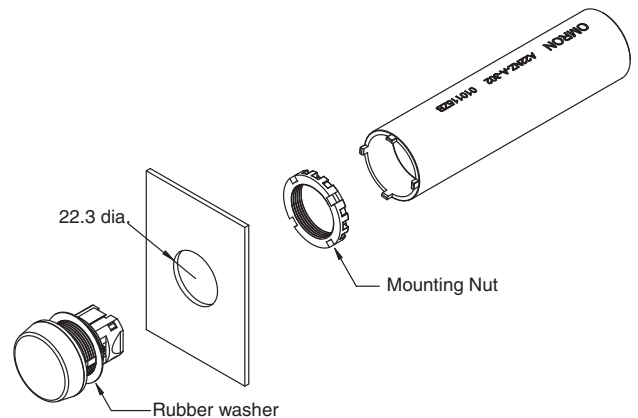

- Panel Hole of 25.5-mm Diameter  
Tighten the Mounting Nut while confirming that the projecting part (see following figure) on the Mounting Nut is aligned with mounting hole. Before tightening, verify that the rubber washer is present between the Operation Unit and the panel.

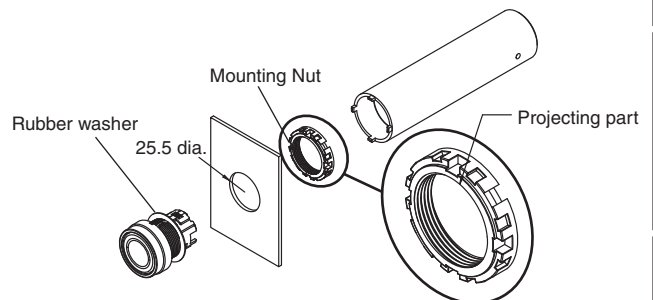

## Mounting the Lock Ring

<A22N/A30N>

- Align the grooves on the Operation Unit with the protruding parts of the Lock Ring and mount.

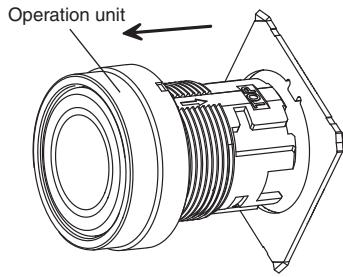

- When experiencing difficulties when mounting a Lock Ring, use the following procedure.

1. Insert the Lock Ring into groove A on the Operation Unit.

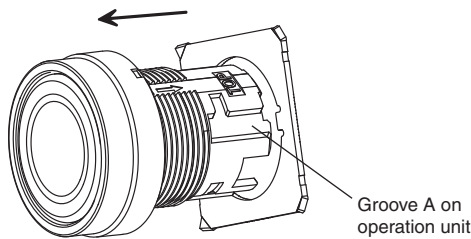

2. When the Lock Ring is in the position shown in the figure below, rotate it to insert the protruding part of the Lock Ring into groove B on the Operation Unit.

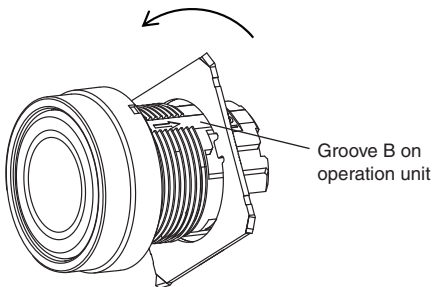

3. When the Lock Ring is in the position shown in the figure below, move it in the direction indicated by the arrow.

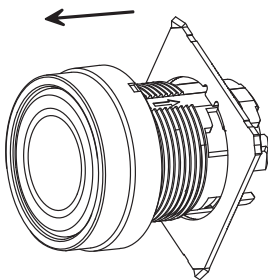

## Mounting the Contact Block to the Operation Unit

<A22N/A30N>

- Insert the Operation Unit into the Mounting Collar, aligning the TOP mark inscribed on the Operation Unit with the lever on the Mounting Collar, and then turn the lever in the direction indicated by the arrow in the following figure all of the way until it clicks into place.

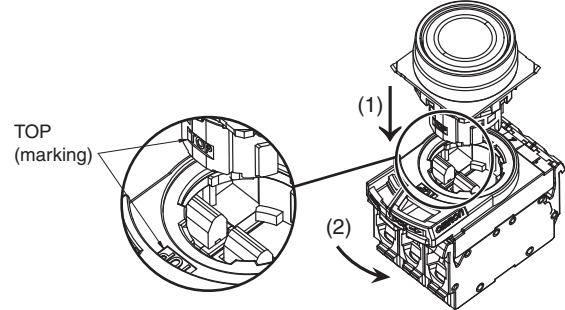

## Removing the Mounting Collar

<A22N/A30N>

- Press the lock lever in from the back side to release the lock, and then hook the Mounting Collar with a screwdriver, move it in the direction indicated at (2), and remove it. Turn the lever all of the way until it clicks into place.

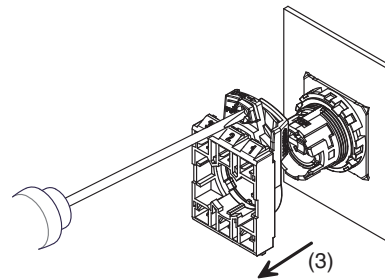
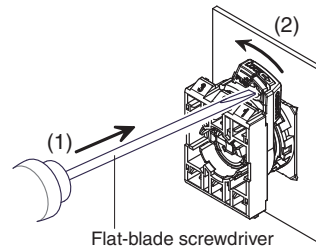

## Attaching the Switch Unit to the Indicator Unit

<M22N>

- Align the "TOP" marks on the Indicator Unit and Switch Unit and insert the Indicator Unit into the Switch Unit. Insert it all the way until it clicks into place.

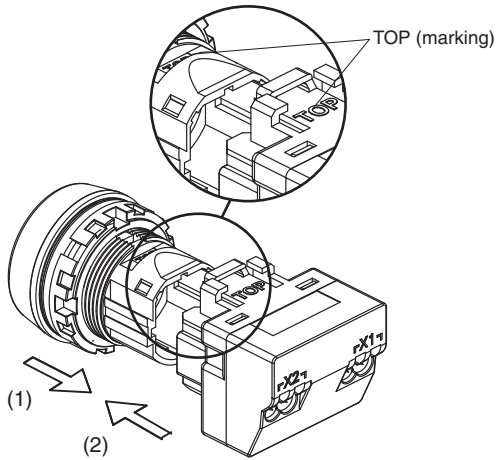

## Removing the Switch Unit

<M22N>

- Insert a screwdriver into the tab on the Switch Unit. Move the screwdriver in direction (2) to remove the Switch Unit.

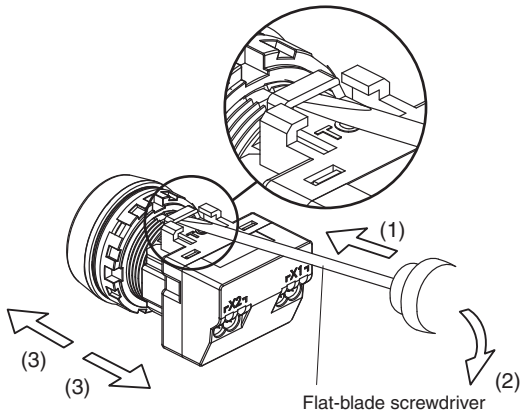

## Contact Block and Lighting Unit

### Attaching the Contact Block and Lighting Unit

- Catch the projection on the opposite side of the Mounting Collar from the lever side and press the Contact Block in the direction indicated at (1). Attach the Lighting Unit at Unit position 2 on the Mounting Collar.

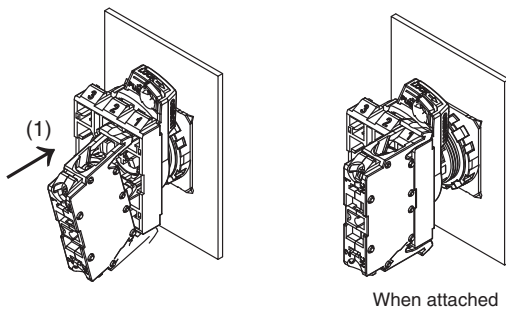

## Removing the Contact Block and Lighting Unit

- Insert a screwdriver into the gap between the Mounting Collar and Contact Block and press it inward in the direction shown at (2). A Lighting Unit can be removed at Unit position 2 on the Mounting Collar.

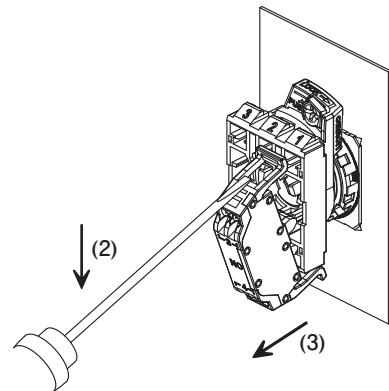
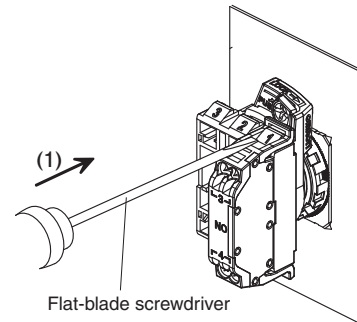

## Attaching the Reinforcement Plate (Screw terminal block type)

- To link Contact Blocks together, attach a Reinforcement Plate in the direction shown in the following figure. To remove the Plate, insert a screwdriver in the direction indicated at (1) and rotate it in the direction indicated at (2).

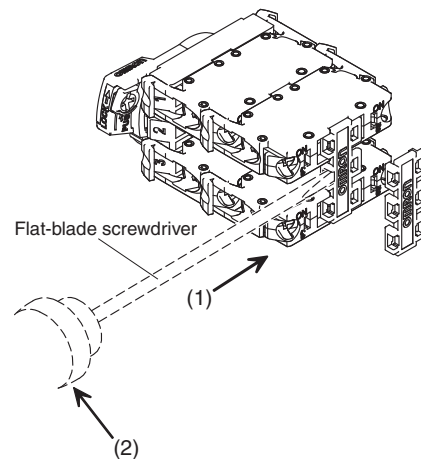

Pushbutton Switches  
A22N

Selector Switches  
A22N

Key-type Selector Switches  
A22N

Indicators  
M22N

Pushbutton Switches  
A30N

Selector Switches  
A30N

Key-type Selector Switches  
A30N

Subassemblies  
(Common)

Accessories  
and Tools

Safety  
Precautions

# A22N/M22N/A30N

## Engraving (Except for Non-Lighted / Opaque Types)

- Engrave legends on the Legend Plates.  
Do so with the straight part of the Legend Plate positioned on the right and left.
- The characters must be engraved no deeper than 0.5 mm. Use an alcohol-based paint, such as a melamine, phthalic acid, or acrylic resin based paint.

### <A22N>

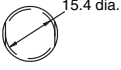
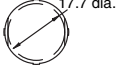
Projected, Full-guard, or Mushroom Switches	Flat Switches
	

### <M22N>

#### Flat Resin Legend Plate Type Switches



## Attaching Character Films (Except for Non-Lighted / Opaque Types)

### <A22N/A30N>

- To attach a character film, remove the Button and attach the film, aligning it with the straight portions of the Legend Plate.

#### Projected Switches

#### Full-guard Switches

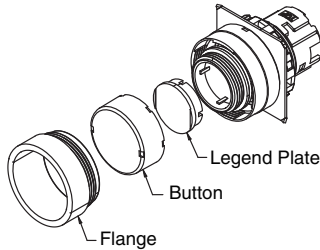
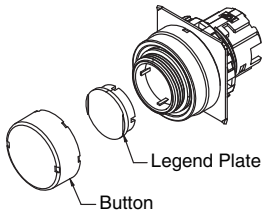

#### Mushroom Switches

#### Flat Switches

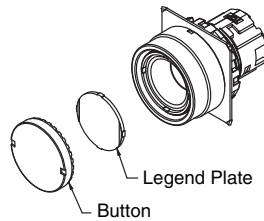
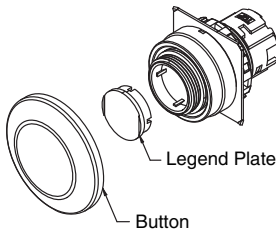

- Prepare films of the following sizes depending on the type of Legend Plate.
- The films must be provided by the user.

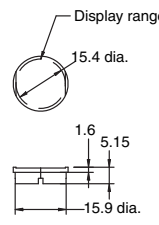
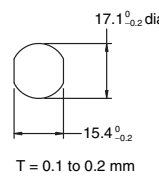
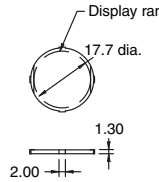
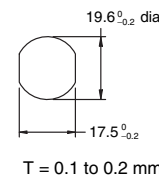
Projected, Full-guard, or Mushroom Switches	Legend Plate dimensions	
	Film dimensions	
Flat Switches	Legend Plate dimensions	
	Film dimensions	

### <M22N>

- To attach a character film, remove the Button and attach the film, aligning it with the straight portions of the Legend Plate.

#### Flat Etched Switches

#### Flat Switches

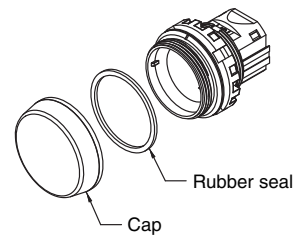
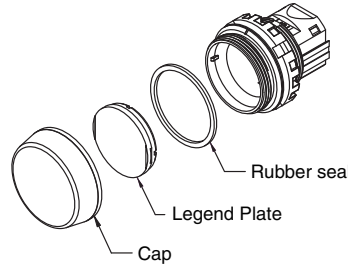

#### Semi-spherical Switches

#### Projected Switches

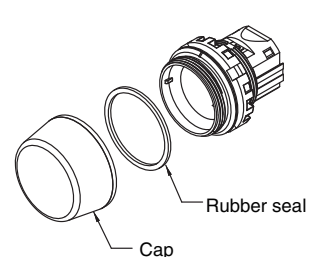
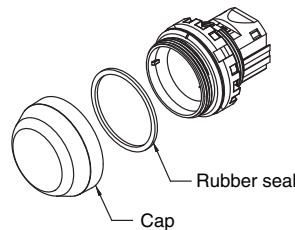

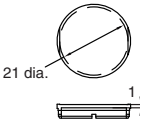
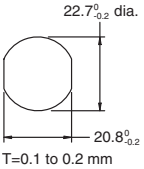

- Film processing dimensions should be as per the indications below.

<b>Legend Plate dimensions</b>	
<b>Film dimensions</b>	

## Removing and Tightening the Cap

For all Switches except for Mushroom Switches, use the A22Z-3908 Cap Tightening Tool to loosen the cap. When you tighten the cap, make sure that the Legend Plate is in the correct position and then turn the cap in the direction opposite of the direction shown in the following figure. Tighten it to a torque of 0.5 to 1.0 N·m so that it will not become loose.

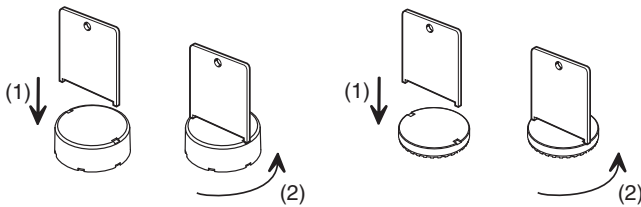

## Attaching the LED Lamp to the Lighting Unit

- Insert the protrusions on the LED Lamp into the guides on the Lighting Unit and then turn the LED Lamp in direction (2) to lock it in place.

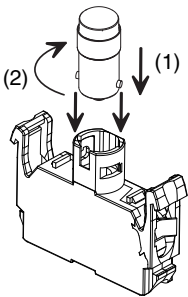

## Attaching and Replacing LED Lamps

### Removing the LED Lamp from the Panel Surface

- Insert the LED Lamp Extractor as shown in the following figure and then rotate the Extractor in the direction shown at (2) while pressing it inward.

<A22N>

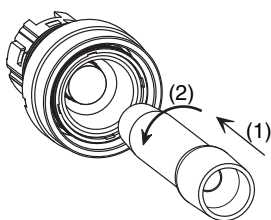

<M22N>

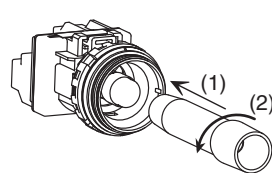

## Attaching the LED Lamp from the Panel Surface

- Insert the LED Lamp into the LED Lamp Extractor as shown in the following figure. Align the projections on the LED Lamp with the LED Lamp insertion guides, insert the LED Lamp, and turn it in the direction indicated at (2).

<A22N>

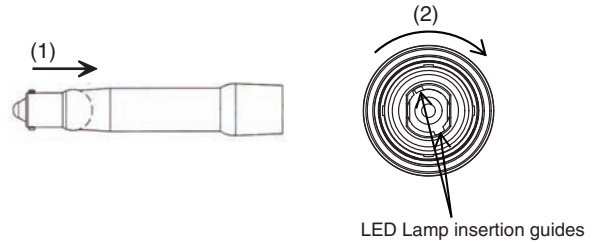

<M22N>

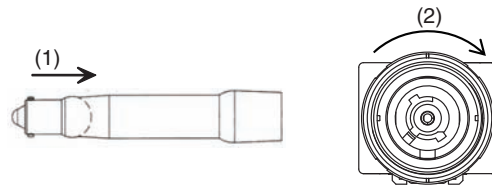

## Control Box

You can attach a Legend Plate Frame.

Attach it in the direction shown in the following figure.

Mount the Switch in the same way as for a standard panel. The tightening torque of the Box screws is 1.4 to 2.0 N·m.

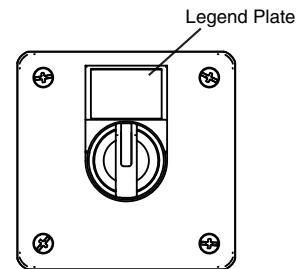

## Creating a Cable Hole

To open a cable hole, leave the cover attached, place the tip of a screwdriver in the grooves at four locations around the cable hole, strike the screwdriver with a hammer in order at the four locations to open the hole, and remove the part from the cable hole.

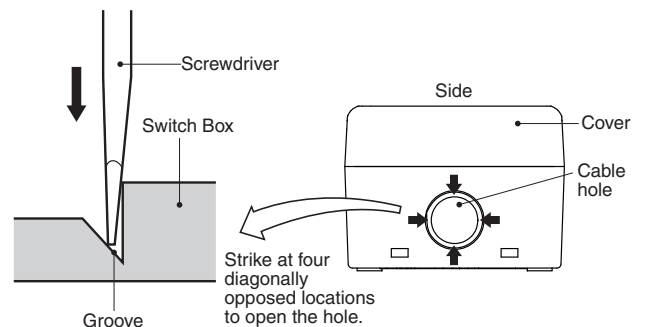

## Attaching the Connector and Cable

1. Insert the connector into the cable port hole in the Box and secure with the fixing nut inside the box.
2. Run the cable through the tightening cap, insert the cable into the connector, and then tighten the hexagonal nut to secure the cable.

Cable diameter (mm)	Connector
7 to 9 dia.	A22Z-3500-1
9 to 11 dia.	A22Z-3500-2

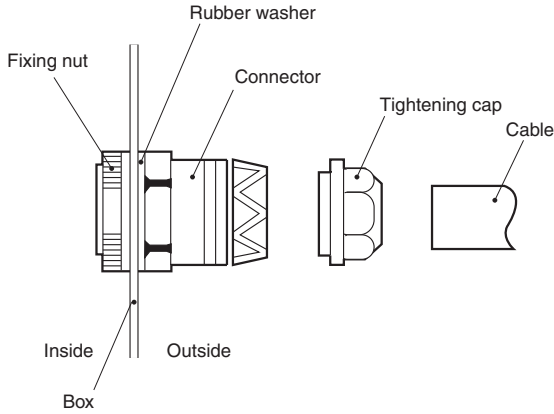

## Attaching and Removing Legend Plates

- Press the Legend Plate into the depression in the Legend Plate Frame. The Legend Plate Frame can be separate or it can be mounted on the panel when you attach the Legend Plate.
- The direction of the characters will depend on the mounting direction of the Operation Unit if the Switch is a Selector Switch or Key Selector Switch.

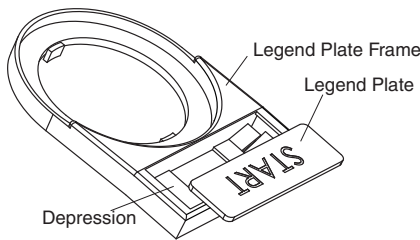

- You can easily remove the Legend Plate by pressing it forwards from the back of the Legend Plate Frame.
- The acrylic plastic Legend Plate is easily damaged by shock. Handle it with care.

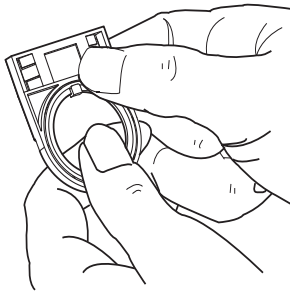

## Attaching the Lock Ring

Attach the Lock Ring as shown in the following figure. To ensure water resistance, attach the rubber washer in the specified location.

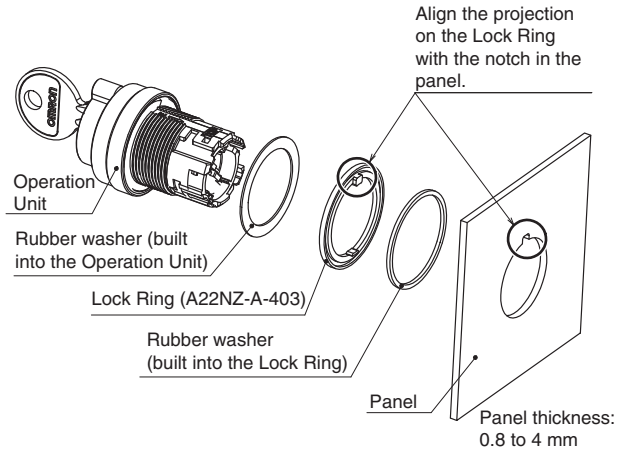

- Align the TOP mark on the Operation Unit, part A on the Legend Plate, and the notch in the panel, and insert the Operation Unit.

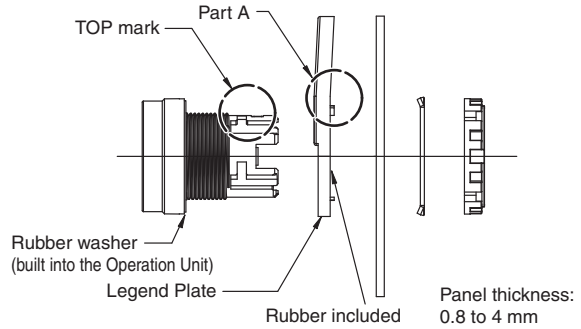

- If there is no notch in the panel, remove part A from the Legend Plate with pliers.

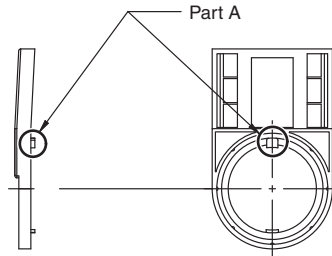

## Attaching the Protective Cover

Attach the Protective Cover (A22NZ-A-303) to a panel that is 0.8 to 1.0 mm thick. To ensure water resistance, attach the rubber washer in the specified location.

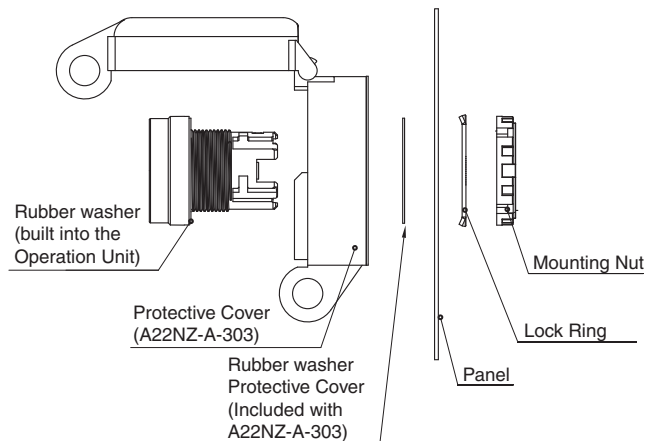

## Attaching the Sealing Cap

<A22N/M22N>

- Panel acceptable thickness is given below.

Panel hole dimension	Panel thickness
22.3 dia.	0.8 to 4.2 mm
25.5 dia.	0.8 to 5.2 mm

### Panel Hole of 22.3-mm Diameter

Attach the Sealing cap as shown in the following figure. To ensure water resistance, attach the rubber washer in the specified location.

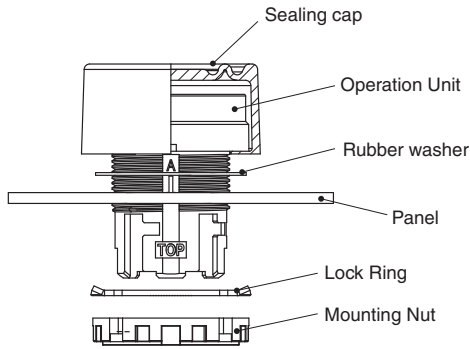

### Panel Hole of 25.5-mm Diameter

Attach the Sealing cap as shown in the following figure. Do not use the Lock Ring, and tighten the Mounting Nut while confirming that the projecting part on the Mounting Nut is aligned with mounting hole. To ensure water resistance, attach the rubber washer in the specified location.

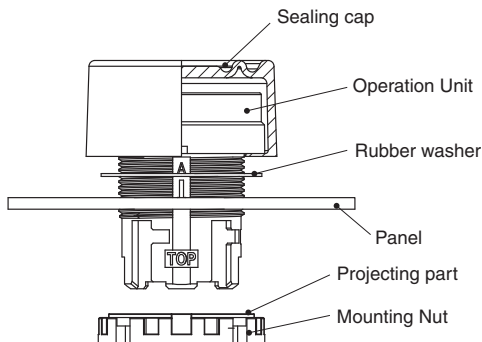

## Mounting the 30-dia. Resin Attachments

<A22N>

- Acceptable panel thickness is between 1.8 and 2.2 mm.
- Mount the attachment as shown in the following figure.
- To ensure water resistance, attach the rubber washer in the specified location.

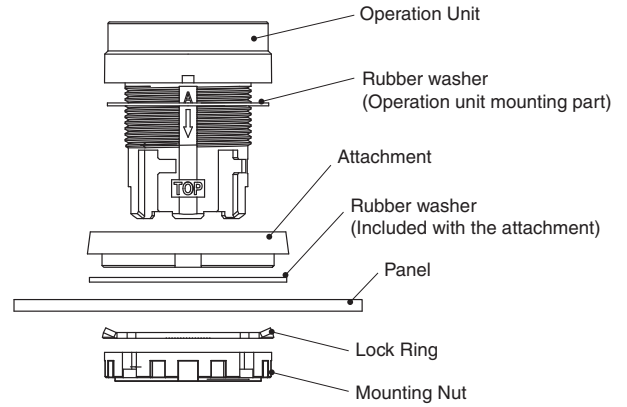

<M22N>

- Acceptable panel thickness is between 1.8 and 2.2 mm.
- Mount the attachment as shown in the following figure.
- Purchase and mount a separate lock ring (A22NZ-A-50501).
- To ensure water resistance, attach the rubber washer in the specified location.

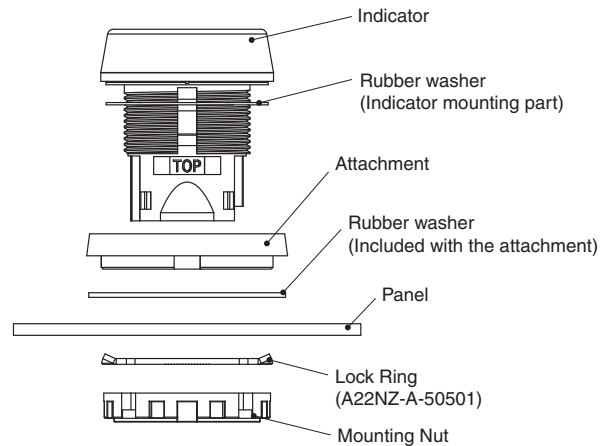







# Terms and Conditions Agreement

## **Read and understand this catalog.**

Please read and understand this catalog before purchasing the products. Please consult your OMRON representative if you have any questions or comments.

## **Warranties.**

- (a) Exclusive Warranty. Omron's exclusive warranty is that the Products will be free from defects in materials and workmanship for a period of twelve months from the date of sale by Omron (or such other period expressed in writing by Omron). Omron disclaims all other warranties, express or implied.
- (b) Limitations. OMRON MAKES NO WARRANTY OR REPRESENTATION, EXPRESS OR IMPLIED, ABOUT NON-INFRINGEMENT, MERCHANTABILITY OR FITNESS FOR A PARTICULAR PURPOSE OF THE PRODUCTS. BUYER ACKNOWLEDGES THAT IT ALONE HAS DETERMINED THAT THE PRODUCTS WILL SUITABLY MEET THE REQUIREMENTS OF THEIR INTENDED USE.

Omron further disclaims all warranties and responsibility of any type for claims or expenses based on infringement by the Products or otherwise of any intellectual property right. (c) Buyer Remedy. Omron's sole obligation hereunder shall be, at Omron's election, to (i) replace (in the form originally shipped with Buyer responsible for labor charges for removal or replacement thereof) the non-complying Product, (ii) repair the non-complying Product, or (iii) repay or credit Buyer an amount equal to the purchase price of the non-complying Product; provided that in no event shall Omron be responsible for warranty, repair, indemnity or any other claims or expenses regarding the Products unless Omron's analysis confirms that the Products were properly handled, stored, installed and maintained and not subject to contamination, abuse, misuse or inappropriate modification. Return of any Products by Buyer must be approved in writing by Omron before shipment. Omron Companies shall not be liable for the suitability or unsuitability or the results from the use of Products in combination with any electrical or electronic components, circuits, system assemblies or any other materials or substances or environments. Any advice, recommendations or information given orally or in writing, are not to be construed as an amendment or addition to the above warranty.

See <http://www.omron.com/global/> or contact your Omron representative for published information.

## **Limitation on Liability; Etc.**

OMRON COMPANIES SHALL NOT BE LIABLE FOR SPECIAL, INDIRECT, INCIDENTAL, OR CONSEQUENTIAL DAMAGES, LOSS OF PROFITS OR PRODUCTION OR COMMERCIAL LOSS IN ANY WAY CONNECTED WITH THE PRODUCTS, WHETHER SUCH CLAIM IS BASED IN CONTRACT, WARRANTY, NEGLIGENCE OR STRICT LIABILITY.

Further, in no event shall liability of Omron Companies exceed the individual price of the Product on which liability is asserted.

## **Suitability of Use.**

Omron Companies shall not be responsible for conformity with any standards, codes or regulations which apply to the combination of the Product in the Buyer's application or use of the Product. At Buyer's request, Omron will provide applicable third party certification documents identifying ratings and limitations of use which apply to the Product. This information by itself is not sufficient for a complete determination of the suitability of the Product in combination with the end product, machine, system, or other application or use. Buyer shall be solely responsible for determining appropriateness of the particular Product with respect to Buyer's application, product or system. Buyer shall take application responsibility in all cases.

NEVER USE THE PRODUCT FOR AN APPLICATION INVOLVING SERIOUS RISK TO LIFE OR PROPERTY OR IN LARGE QUANTITIES WITHOUT ENSURING THAT THE SYSTEM AS A WHOLE HAS BEEN DESIGNED TO ADDRESS THE RISKS, AND THAT THE OMRON PRODUCT(S) IS PROPERLY RATED AND INSTALLED FOR THE INTENDED USE WITHIN THE OVERALL EQUIPMENT OR SYSTEM.

## **Programmable Products.**

Omron Companies shall not be responsible for the user's programming of a programmable Product, or any consequence thereof.

## **Performance Data.**

Data presented in Omron Company websites, catalogs and other materials is provided as a guide for the user in determining suitability and does not constitute a warranty. It may represent the result of Omron's test conditions, and the user must correlate it to actual application requirements. Actual performance is subject to the Omron's Warranty and Limitations of Liability.

## **Change in Specifications.**

Product specifications and accessories may be changed at any time based on improvements and other reasons. It is our practice to change part numbers when published ratings or features are changed, or when significant construction changes are made. However, some specifications of the Product may be changed without any notice. When in doubt, special part numbers may be assigned to fix or establish key specifications for your application. Please consult with your Omron's representative at any time to confirm actual specifications of purchased Product.

## **Errors and Omissions.**

Information presented by Omron Companies has been checked and is believed to be accurate; however, no responsibility is assumed for clerical, typographical or proofreading errors or omissions.

**OMRON Corporation** Industrial Automation Company  
Kyoto, JAPAN

Contact: [www.ia.omron.com](http://www.ia.omron.com)

**Regional Headquarters**

**OMRON EUROPE B.V.**

Wegalaan 67-69, 2132 JD Hoofddorp  
The Netherlands  
Tel: (31)2356-81-300/Fax: (31)2356-81-388

**OMRON ELECTRONICS LLC**

2895 Greenspoint Parkway, Suite 200  
Hoffman Estates, IL 60169 U.S.A.  
Tel: (1) 847-843-7900/Fax: (1) 847-843-7787

**OMRON ASIA PACIFIC PTE. LTD.**

No. 438A Alexandra Road # 05-05/08 (Lobby 2),  
Alexandra Technopark,  
Singapore 119967  
Tel: (65) 6835-3011/Fax: (65) 6835-2711

**OMRON (CHINA) CO., LTD.**

Room 2211, Bank of China Tower,  
200 Yin Cheng Zhong Road,  
PuDong New Area, Shanghai, 200120, China  
Tel: (86) 21-5037-2222/Fax: (86) 21-5037-2200

**Authorized Distributor:**

© OMRON Corporation 2016 All Rights Reserved.  
In the interest of product improvement,  
specifications are subject to change without notice.

**CSM\_4\_1\_0717**  
**Cat. No. A254-E1-01**

0916(0916)



# Mouser Electronics

Authorized Distributor

Click to View Pricing, Inventory, Delivery & Lifecycle Information:

## Omron:

[A22NK-2BL-01BA-G002](#) [A22NK-2BL-01BA-G100](#) [A22NK-2BL-01BA-G101](#) [A22NK-2BL-01BA-G102](#) [A22NK-2BL-01BA-G202](#) [A22NK-2BM-01AA-G002](#) [A22NK-3RM-01DA-G102](#) [A22NK-3RM-01DA-G202](#) [A22NK-3RM-01GA-G101](#) [A22NK-3RM-01GA-G102](#) [A22NK-3RM-01GA-G202](#) [A22NK-3RB-01DA-G101](#) [A22NK-3RB-01DA-G102](#) [A22NK-3RB-01DA-G202](#) [A22NK-3RM-01BA-G101](#) [A22NK-3RM-01BA-G102](#) [A22NK-3RM-01DA-G101](#) [A22NK-3MM-01DA-G101](#) [A22NK-3MM-01DA-G102](#) [A22NK-3MM-01DA-G202](#) [A22NK-3MM-01GA-G101](#) [A22NK-3MM-01GA-G102](#) [A22NK-3MM-01GA-G202](#) [A22NK-3BM-01GA-G202](#) [A22NK-3MB-01DA-G101](#) [A22NK-3MB-01DA-G102](#) [A22NK-3MB-01DA-G202](#) [A22NK-3MM-01BA-G101](#) [A22NK-3MM-01BA-G102](#) [A22NK-3BM-01BA-G102](#) [A22NK-3BM-01DA-G101](#) [A22NK-3BM-01DA-G102](#) [A22NK-3BM-01DA-G202](#) [A22NK-3BM-01GA-G101](#) [A22NK-3BM-01GA-G102](#) [A22NK-2RM-01BA-G111](#) [A22NK-2RM-01BA-G202](#) [A22NK-3BB-01DA-G101](#) [A22NK-3BB-01DA-G102](#) [A22NK-3BB-01DA-G202](#) [A22NK-3BM-01BA-G101](#) [A22NK-2RM-01AA-G100](#) [A22NK-2RM-01AA-G101](#) [A22NK-2RM-01AA-G102](#) [A22NK-2RM-01AA-G202](#) [A22NK-2RM-01BA-G002](#) [A22NK-2RM-01BA-G101](#) [A22NK-2RL-01BA-G002](#) [A22NK-2RL-01BA-G100](#) [A22NK-2RL-01BA-G101](#) [A22NK-2RL-01BA-G102](#) [A22NK-2RL-01BA-G202](#) [A22NK-2RM-01AA-G002](#) [A22NK-2MM-01AA-G202](#) [A22NK-2MM-01BA-G002](#) [A22NK-2MM-01BA-G100](#) [A22NK-2MM-01BA-G101](#) [A22NK-2MM-01BA-G102](#) [A22NK-2MM-01BA-G202](#) [A22NK-2ML-01BA-G102](#) [A22NK-2ML-01BA-G202](#) [A22NK-2MM-01AA-G002](#) [A22NK-2MM-01AA-G100](#) [A22NK-2MM-01AA-G101](#) [A22NK-2MM-01AA-G102](#) [A22NK-2BM-01BA-G101](#) [A22NK-2BM-01BA-G102](#) [A22NK-2BM-01BA-G202](#) [A22NK-2ML-01BA-G002](#) [A22NK-2ML-01BA-G100](#) [A22NK-2ML-01BA-G101](#) [A22NK-2BM-01AA-G100](#) [A22NK-2BM-01AA-G101](#) [A22NK-2BM-01AA-G102](#) [A22NK-2BM-01AA-G202](#) [A22NK-2BM-01BA-G002](#) [A22NK-2BM-01BA-G100](#) [M22N-BC-TWA-YC-P](#) [M22N-BC-TWA-YD-P](#) [M22N-BC-TGA-GA-P](#) [M22N-BC-TGA-GB-P](#) [M22N-BC-TGA-GC-P](#) [M22N-BC-TGA-GD-P](#) [M22N-BC-TGA-GE-P](#) [M22N-BC-TOA-OA-P](#) [M22N-BC-TOA-OB-P](#) [M22N-BC-TOA-OC-P](#) [M22N-BG-TOA-OE-P](#) [M22N-BG-TRA-RA-P](#) [M22N-BG-TRA-RB-P](#) [M22N-BG-TRA-RC-P](#) [M22N-BG-TRA-RD-P](#) [M22N-BG-TRA-RE-P](#) [M22N-BG-TWA-WA-P](#) [M22N-BG-TWA-WB-P](#) [M22N-BG-TWA-WC-P](#) [M22N-BG-TWA-WD-P](#) [M22N-BG-TWA-WE-P](#) [M22N-BN-TAA-AB-P](#) [M22N-BN-TAA-AC-P](#)