

SAC-3P-M12MR/1,5-PUR/M 8FS - Sensor/actuator cable



1668894

<https://www.phoenixcontact.com/us/products/1668894>

Please be informed that the data shown in this PDF document is generated from our online catalog. Please find the complete data in the user documentation. Our general terms of use for downloads are valid.



Sensor/actuator cable, 3-position, PUR halogen-free, black-gray RAL 7021, Plug angled M12, coding: A, on Socket straight M8, cable length: 1.5 m

Your advantages

- Easy and safe: 100 % electrically tested plug-in components

Commercial data

Item number	1668894
Packing unit	1 pc
Minimum order quantity	1 pc
Sales key	BF03
Product key	BF1CBA
Catalog page	Page 188 (C-2-2019)
GTIN	4017918135812
Weight per piece (including packing)	40.2 g
Weight per piece (excluding packing)	37.264 g
Customs tariff number	85444290
Country of origin	DE

SAC-3P-M12MR/1,5-PUR/M 8FS - Sensor/actuator cable



1668894

<https://www.phoenixcontact.com/us/products/1668894>

Technical data

Product properties

Product type	Sensor/actuator cable
Application	Standard
Number of positions	3
No. of cable outlets	1
Shielded	no
Coding	A

Insulation characteristics

Overvoltage category	II
Degree of pollution	3

Material specifications

Flammability rating according to UL 94	HB
Seal material	NBR
Material of grip body	TPU, hardly inflammable, self-extinguishing
Contact material	CuSn
Contact surface material	Ni/Au
Contact carrier material	TPU GF
Material for screw connection	Zinc die-cast, nickel-plated

Electrical properties

Insulation resistance	$\geq 100 \text{ M}\Omega$
Nominal voltage U_N	48 V AC
	60 V DC
Nominal current I_N	4 A

Mechanical properties

Mechanical data

Insertion/withdrawal cycles	≥ 100
-----------------------------	------------

Signaling

Status display	No
Status display present	No

Connection data

Conductor connection

Tightening torque	0.4 Nm (M12 connector)
	0.2 Nm (M8 connectors)

Connector

SAC-3P-M12MR/1,5-PUR/M 8FS - Sensor/actuator cable



1668894

<https://www.phoenixcontact.com/us/products/1668894>

Connection 1

Type	Plug angled M12
Number of positions	3
Coding type	A

Connection 2

Type	Socket straight M8
Number of positions	3

Cable/line

Cable length	1.5 m
--------------	-------

PUR halogen-free black [PUR]

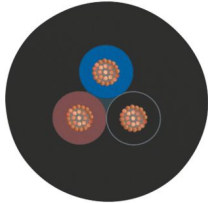
Dimensional drawing	
Cable weight	18 kg/km
UL AWM Style	20549 / 10493 (80°C/300 V)
Number of positions	3
Shielded	no
Cable type	PUR halogen-free black [PUR]
Conductor structure signal line	32x 0.10 mm
AWG signal line	24
Conductor cross section	3x 0.25 mm ² (Signal line)
Wire diameter incl. insulation	1.17 mm ±0.02 mm
External cable diameter	3.60 mm ±0.15 mm
Outer sheath, material	PUR
External sheath, color	black-gray RAL 7021
Conductor material	Bare Cu litz wires
Material wire insulation	PP
Single wire, color	brown, blue, black
Thickness, insulation	≥ 0.21 mm (Core insulation)
Thickness, outer sheath	approx. 0.50 mm
Overall twist	3 wires, twisted
Length of twist, overall twist	40 mm
Max. conductor resistance	≤ 78 Ω/km (at 20 °C)
Insulation resistance	≥ 100 GΩ*km (at 20 °C)
Nominal voltage, cable	≤ 300 V
Test voltage	≥ 3000 V

SAC-3P-M12MR/1,5-PUR/M 8FS - Sensor/actuator cable



1668894

<https://www.phoenixcontact.com/us/products/1668894>

Smallest bending radius, fixed installation	18 mm
Smallest bending radius, movable installation	36 mm
Max. bending cycles	10000000
Bending radius	44 mm
Traversing path	10 m
Traversing rate	3 m/s
Acceleration	10 m/s ²
Halogen-free	in accordance with DIN VDE 0472 part 815
Flame resistance	in accordance with UL 758/1581 FT2 DIN EN 60332-2-2 (20 s)
Resistance to oil	in accordance with DIN EN 60811-2-1
Other resistance	hydrolysis and microbe resistant Highly resistant to acids, alkaline solutions and solvents Resistant to salt water partly UV-resistant (in accordance with DIN EN ISO 4892-2-A)
Special properties	Flexible cable conduit capable Silicone-free Free of substances which would hinder coating with paint or varnish
Ambient temperature (operation)	-40 °C ... 80 °C (cable, fixed installation) -25 °C ... 80 °C (Cable, flexible installation)

Environmental and real-life conditions

Ambient conditions

Degree of protection	IP65
	IP67
	IP68
Ambient temperature (operation)	-25 °C ... 90 °C (Plug / socket)
	-40 °C ... 80 °C (cable, fixed installation)
	-5 °C ... 80 °C (Cable, flexible installation)

Standards and regulations

Standard designation	M12 connector
Standards/specifications	IEC 61076-2-101
Standard designation	M8 connector
Standards/specifications	IEC 61076-2-104

SAC-3P-M12MR/1,5-PUR/M 8FS - Sensor/actuator cable

1668894

<https://www.phoenixcontact.com/us/products/1668894>

Drawings

Dimensional drawing

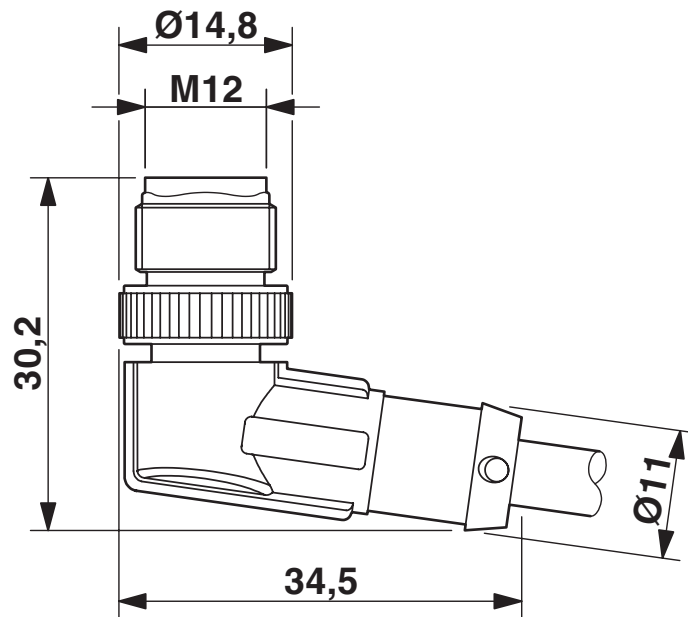

M12 x 1 male plug, angled

Circuit diagram

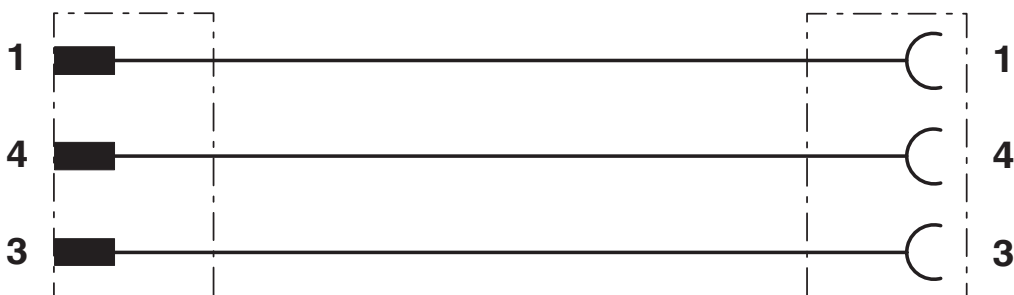

SAC-3P-M12MR/1,5-PUR/M 8FS - Sensor/actuator cable

1668894

<https://www.phoenixcontact.com/us/products/1668894>

Schematic diagram

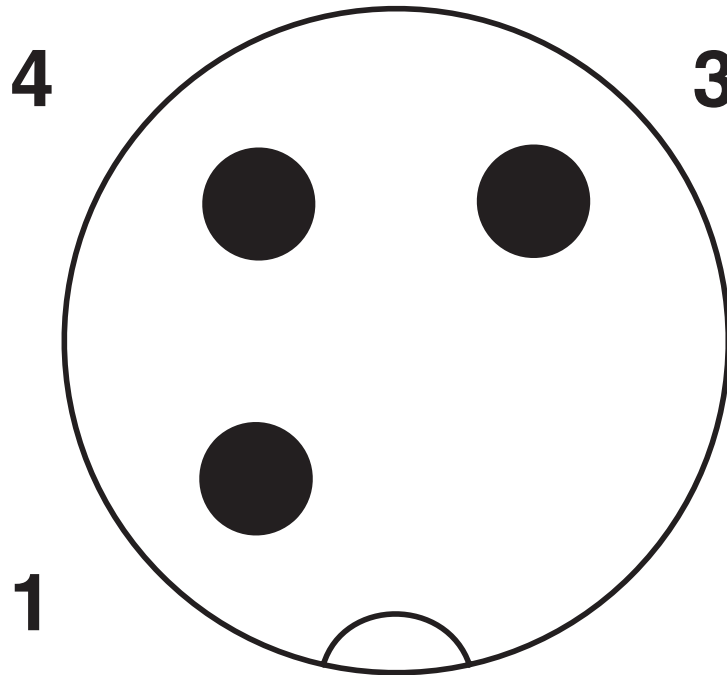

Pin assignment M12 plug, 3-pos., A-coded, view male side

Schematic diagram

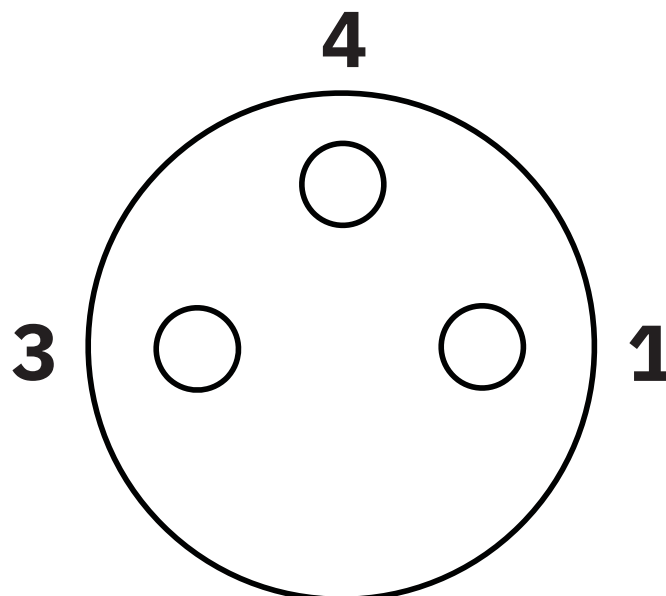

Pin assignment M8 socket, 3-pos., view female side

SAC-3P-M12MR/1,5-PUR/M 8FS - Sensor/actuator cable

1668894

<https://www.phoenixcontact.com/us/products/1668894>

Dimensional drawing

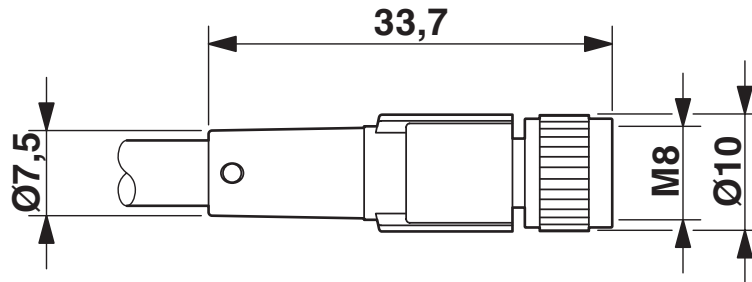

Socket M8 x 1, straight

SAC-3P-M12MR/1,5-PUR/M 8FS - Sensor/actuator cable





1668894

<https://www.phoenixcontact.com/us/products/1668894>

Approvals

To download certificates, visit the product detail page: <https://www.phoenixcontact.com/us/products/1668894>

 UL Listed Approval ID: FILE E 221474				
	Nominal voltage U_N	Nominal current I_N	Cross section AWG	Cross section mm^2
	60 V	4 A	-	-

 cUL Listed Approval ID: FILE E 221474				
	Nominal voltage U_N	Nominal current I_N	Cross section AWG	Cross section mm^2
	60 V	4 A	-	-

 EAC-RoHS Approval ID: RU D-DE.HB35.B.00387	
---	--

cULus Listed

SAC-3P-M12MR/1,5-PUR/M 8FS - Sensor/actuator cable



1668894

<https://www.phoenixcontact.com/us/products/1668894>

Classifications

ECLASS

ECLASS-11.0	27060311
ECLASS-12.0	27060311
ECLASS-13.0	27060311

ETIM

ETIM 9.0	EC001855
----------	----------

UNSPSC

UNSPSC 21.0	26121600
-------------	----------

SAC-3P-M12MR/1,5-PUR/M 8FS - Sensor/actuator cable



1668894

<https://www.phoenixcontact.com/us/products/1668894>

Environmental product compliance

EU RoHS

Fulfills EU RoHS substance requirements	Yes, No exemptions
---	--------------------

China RoHS

Environment friendly use period (EFUP)	EFUP-E
	No hazardous substances above the limits

EU REACH SVHC

REACH candidate substance (CAS No.)	No substance above 0.1 wt%
-------------------------------------	----------------------------

SAC-3P-M12MR/1,5-PUR/M 8FS - Sensor/actuator cable



1668894

<https://www.phoenixcontact.com/us/products/1668894>

Accessories

PROT-M12 FS-PA-CHAIN - Sealing cap

1430873

<https://www.phoenixcontact.com/us/products/1430873>

M12 sealing cap made of plastic with fixing band, for sensor cables, for free M12 plugs



SAC-M12-EXCLIP-M - Locking clip

1558988

<https://www.phoenixcontact.com/us/products/1558988>

Locking clip for the pin side of sensor/actuator cables with M12 connector and M12 connectors for assembly, for knurl diameter: 15 mm or for Allen key with a wrench size of 14 mm, prevents the disconnection of plug-in connections without tools



SAC-3P-M12MR/1,5-PUR/M 8FS - Sensor/actuator cable



1668894

<https://www.phoenixcontact.com/us/products/1668894>

UCT-WMT (23X4) - Conductor marker

0801453

<https://www.phoenixcontact.com/us/products/0801453>



Conductor marker, Sheet, white, unlabeled, can be labeled with: TOPMARK NEO, TOPMARK LASER, BLUEMARK ID COLOR, BLUEMARK ID, BLUEMARK CLED, THERMOMARK PRIME, THERMOMARK CARD 2.0, THERMOMARK CARD, mounting type: insert, cable diameter range: 1.5 ... 35 mm, lettering field size: 23 x 4 mm, Number of individual labels: 30

UC-WMT (23X4) - Conductor marker

0819411

<https://www.phoenixcontact.com/us/products/0819411>



Conductor marker, Sheet, white, unlabeled, can be labeled with: BLUEMARK ID COLOR, BLUEMARK ID, BLUEMARK CLED, PLOTMARK, CMS-P1-PLOTTER, mounting type: insert, cable diameter range: 1.5 ... 35 mm, lettering field size: 23 x 4 mm, Number of individual labels: 24

SAC-3P-M12MR/1,5-PUR/M 8FS - Sensor/actuator cable



1668894

<https://www.phoenixcontact.com/us/products/1668894>

US-WMT (23X4) - Cable marker

0828769

<https://www.phoenixcontact.com/us/products/0828769>



Cable marker, Card, white, unlabeled, can be labeled with: BLUEMARK ID COLOR, BLUEMARK ID, THERMOMARK PRIME, THERMOMARK CARD 2.0, THERMOMARK CARD, mounting type: slide-on, cable diameter range: 1.5 ... 35 mm, lettering field size: 23 x 4 mm, Number of individual labels: 56

WMTW (23X4)R - Cable marker

0831004

<https://www.phoenixcontact.com/us/products/0831004>



Cable marker, Roll, white, unlabeled, can be labeled with: THERMOMARK E.300 (D)/600 (D), THERMOMARK ROLL 2.0, THERMOMARK ROLL, THERMOMARK ROLL X1, THERMOMARK ROLLMASTER 300/600, THERMOMARK X1.2, mounting type: insert, cable diameter range: 1.5 ... 35 mm, lettering field size: 23 x 4 mm, Number of individual labels: 3000

SAC-3P-M12MR/1,5-PUR/M 8FS - Sensor/actuator cable



1668894

<https://www.phoenixcontact.com/us/products/1668894>

PROT-M 8 MS-PA-CHAIN - Screw plug

1430860

<https://www.phoenixcontact.com/us/products/1430860>

M8 sealing cap made of plastic with fixing band for sensor cables, for M8 sockets



B-STIFT - Marker pen

1051993

<https://www.phoenixcontact.com/us/products/1051993>

Marker pen, for manual labeling of unprinted Zack strips, smear-proof and waterproof, line thickness 0.5 mm



SAC-3P-M12MR/1,5-PUR/M 8FS - Sensor/actuator cable

1668894

<https://www.phoenixcontact.com/us/products/1668894>

TSD 02 SAC - Torque screwdriver

1208487

<https://www.phoenixcontact.com/us/products/1208487>



Torque screwdriver, with preset torque of 0.2 Nm and 4 mm hexagonal drive for M8 connectors

SAC BIT M8-D10 - Tool

1208461

<https://www.phoenixcontact.com/us/products/1208461>



Nut for assembling M8 connectors with longitudinal knurl and a knurl diameter of 10 mm, for 4 mm hexagonal drive

SAC-3P-M12MR/1,5-PUR/M 8FS - Sensor/actuator cable



1668894

<https://www.phoenixcontact.com/us/products/1668894>

TSD 04 SAC - Torque screwdriver

1208429

<https://www.phoenixcontact.com/us/products/1208429>



Torque screwdriver, with preset torque of 0.4 Nm and 4 mm hexagonal drive for M12 connectors

TSD-M 1,2NM - Torque screwdriver

1212224

<https://www.phoenixcontact.com/us/products/1212224>



Torque screw driver, accuracy as per EN ISO 6789 standard, adjustable from 0.3 - 1.2 Nm

SAC-3P-M12MR/1,5-PUR/M 8FS - Sensor/actuator cable



1668894

<https://www.phoenixcontact.com/us/products/1668894>

TSD-M SAC-BIT ADAPTER - Adapter insert

1212600

<https://www.phoenixcontact.com/us/products/1212600>



Adapter bit for TSD-M...torque tools, E6.3-1/4" drive with 4 mm hexagon to accommodate SAC bits

SAC BIT M12-D15 - Tool

1208432

<https://www.phoenixcontact.com/us/products/1208432>



Nut for assembling sensor/actuator cables with M12 connector and M12 connectors for assembly, with a knurl diameter of 15 mm, for 4 mm hexagonal drive

Phoenix Contact 2024 © - all rights reserved
<https://www.phoenixcontact.com>

Phoenix Contact USA
586 Fulling Mill Road
Middletown, PA 17057, United States
(+717) 944-1300
info@phoenixcon.com