



AC/DC Converter
Isolation Fly-back Converter PWM method
24W 12V
BM2P0161 Reference Board

User's Guide

<High Voltage Safety Precautions>

- ◇ Read all safety precautions before use

Please note that this document covers only the BM2P0161 evaluation board (BM2P0161-EVK-003) and its functions. For additional information, please refer to the datasheet.

To ensure safe operation, please carefully read all precautions before handling the evaluation board



Depending on the configuration of the board and voltages used,

Potentially lethal voltages may be generated.

Therefore, please make sure to read and observe all safety precautions described in the red box below.

Before Use

- [1] Verify that the parts/components are not damaged or missing (i.e. due to the drops).
- [2] Check that there are no conductive foreign objects on the board.
- [3] Be careful when performing soldering on the module and/or evaluation board to ensure that solder splash does not occur.
- [4] Check that there is no condensation or water droplets on the circuit board.

During Use

- [5] Be careful to not allow conductive objects to come into contact with the board.
- [6] **Brief accidental contact or even bringing your hand close to the board may result in discharge and lead to severe injury or death.**

Therefore, DO NOT touch the board with your bare hands or bring them too close to the board. In addition, as mentioned above please exercise extreme caution when using conductive tools such as tweezers and screwdrivers.

- [7] If used under conditions beyond its rated voltage, it may cause defects such as short-circuit or, depending on the circumstances, explosion or other permanent damages.
- [8] Be sure to wear insulated gloves when handling is required during operation.

After Use

- [9] The ROHM Evaluation Board contains the circuits which store the high voltage. Since it stores the charges even after the connected power circuits are cut, please discharge the electricity after using it, and please deal with it after confirming such electric discharge.
- [10] Protect against electric shocks by wearing insulated gloves when handling.

This evaluation board is intended for use only in research and development facilities and should be handled **only by qualified personnel familiar with all safety and operating procedures.**

We recommend carrying out operation in a safe environment that includes the use of high voltage signage at all entrances, safety interlocks, and protective glasses.

AC/DC Converter

Isolation Fly-back Converter PWM method Output 24W 12V

BM2P0161 Reference Board

BM2P0161-EVK-003

ROHM BM2P0161-EVK-003 is from wide input voltage (90Vac~264Vac) to output 12V 2A max. Constant Voltage Reference board. It used to PWM method DC/DC Converter IC BM2P0161.

BM2P0161 is including 650V High voltage power MOSFET and starter. The starter realize low Stand-by Power. Output voltage control method is used current mode regulation, therefore it can used cycle by cycle current limit. Quick response in dynamic load changing is achieved.

Switching frequency is fixed 65 kHz. Light load situation has frequency decrease function for higher efficiency. Switching frequency jitter function enables lower EMI operation. Various functions are included for safety, Soft start, Frequency Burst Mode, VCC OVP, Output OLP and thermal shut down.

Electronics Characteristics

Not guarantee the characteristics, is representative value. Unless otherwise noted: $V_{IN} = 230\text{Vac}$, $I_{OUT} = 500\text{mA}$, $T_a: 25^\circ\text{C}$

Table 1. Evaluation Board Specification

Description	Min	Typ	Max	Units	Conditions
Input Voltage Range	90	-	264	Vac	
Input Frequency Range	47	50/60	63	Hz	
Output Voltage	10.8	12.0	13.2	V	
Output Maximum Power	-	-	24	W	$I_{OUT} = 2\text{A}$
Output Current Range	0.0	1.5	2.0	A	(Note 1)
No Load Power Consumption	-	73	-	mW	$I_{OUT} = 0\text{A}$
Efficiency	80.0	86.0	-	%	Output:24V 1.5A
Output Ripple Voltage	-	190	-	mV	BW=20MHz, (note 2)

(NOTE1) Please adjust operating time, within any parts surface temperature under 105°C

(NOTE2) Not include spike noise

Operation Procedure

1. Operation Equipment

- (1) AC Power supply 90Vac~264Vac, over 100W
- (2) Electronic Load capacity 2A
- (3) Multi meter

2. Connect method

- (1) AC power supply presetting range 90~264Vac, Output switch is off.
- (2) Load setting under 2A. Load switch is off.
- (3) AC power supply N terminal connect to the board AC (N) of CN1, and L terminal connect to AC (L).
- (4) Load + terminal connect to VOUT, GND terminal connect to GND terminal
- (5) AC power meter connect between AC power supply and board.
- (6) Output test equipment connects to output terminal
- (7) AC power supply switch ON.
- (8) Check that output voltage is 12V.
- (9) Electronic load switch ON
- (10) Check output voltage drop by load connect wire resistance

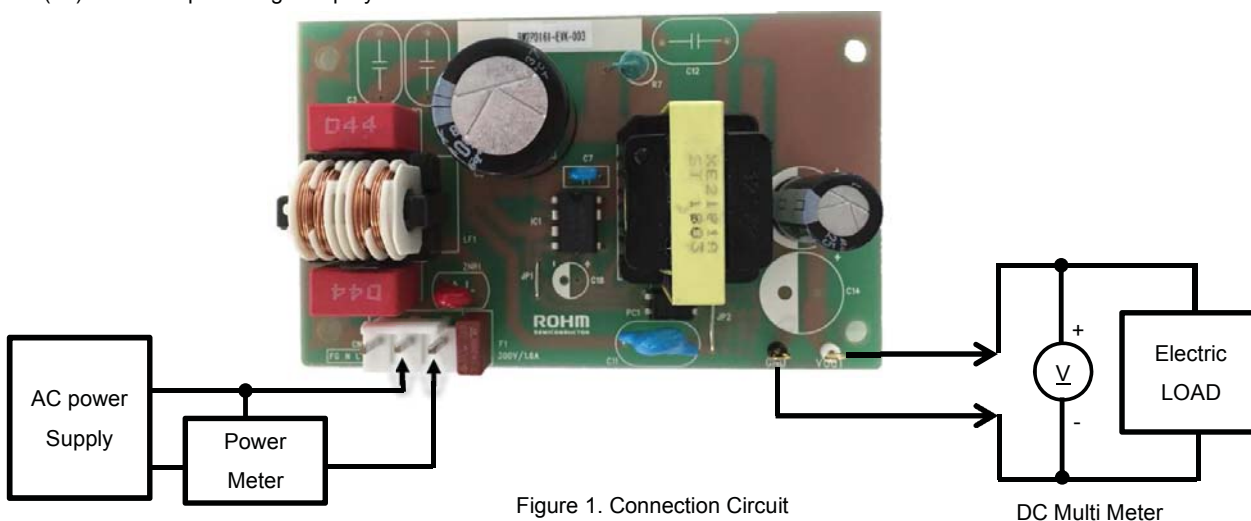

Figure 1. Connection Circuit

Deleting

Maximum Output Power P_o of this reference board is 24W. The derating curve is shown on the right. Please adjust load continuous time by over 105°C of any parts surface temperature within the operating temperature range (-10~65°C).

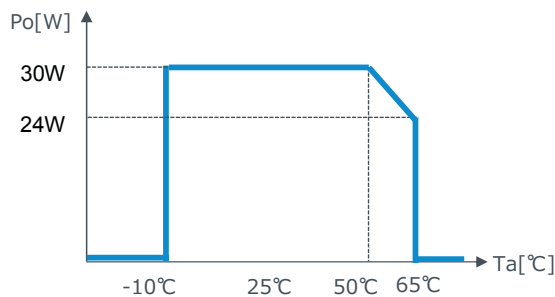

Figure 2. Temperature Derating curve

Schematics

V_{IN} = 90~264Vac, V_{OUT} = 12V

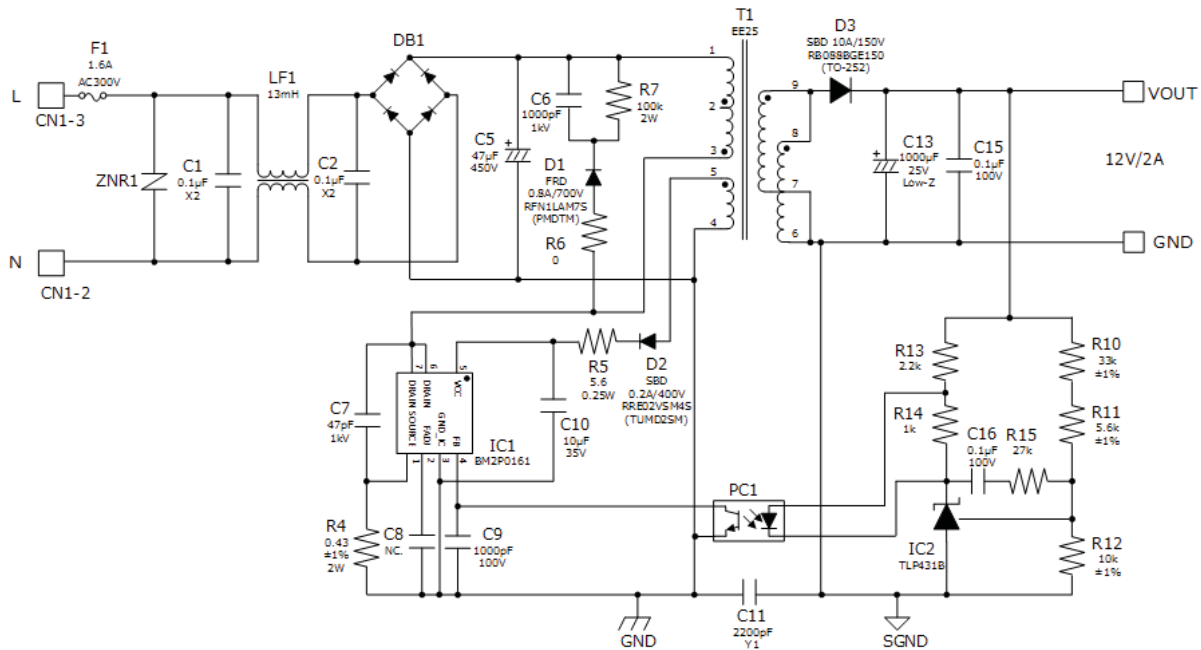

Figure 3. BM2P0161-EVK-003 Schematics

Bill of Materials

Table 2. BoM of BM2P0161-EVK-003

Part Reference	Qty.	Type	Value	Description	Part Number	Manufacture	Configuration mm (inch)
C1,C2	2	X2 Capacitor	0.1µF	300Vac, ±20%	890324023023CS	Würth	-
C5	1	Electrolytic	47µF	450V, ±20%	450BXW47MEFR16X25	Rubycon	16mmΦX25mm
C6	1	Ceramic	2200pF	1000V, X7R, ±10%	GRM31BR73A222KW01	Murata	3216 (1206)
C7	1	Ceramic	47pF	1000V, X7R, ±10%	RDE5C3A470J2K1H03B	Murata	-
C8	0	Ceramic	NC	-	-	-	1608 (0603)
C9	1	Ceramic	1000pF	100V, X7R, ±10%	HMK107B7102KA-T	Taiyo Yuden	1608 (0603)
C10	1	Ceramic	10µF	35V, ±10%	GMK316AB7106KL-TR	Taiyo Yuden	3216 (1206)
C11	1	Y1 Capacitor	2200pF	Y1 capacitor	DE1E3KX222MB4BP01F	Murata	-
C13	1	Electrolytic	1000µF	25V, ±20%	25ZLJ1000M10X20	Rubycon	10mmΦX20mm
C15,C16	2	Ceramic	0.1µF	100V, X7R, ±10%	HMK107B7104KA-T	Taiyo Yuden	1608 (0603)
D1	1	FRD	0.8A	700V	RFN1LAM7S	ROHM	PMDTM
D2	1	REC Di	0.2A	400V	RRE02VSM4S	ROHM	TUMD2SM
D3	1	SBD	10A	150V	RB088BGE150	ROHM	TO-252
DB1	1	Bridge	1A	800V	D1UBA80	Shindengen	SOP-4
F1	1	Fuse	1.6A	1.6A 300V	36911600000	Littelfuse	-
IC1	1	AC/DC Converter	-	650V	BM2P0161	ROHM	DIP7
IC2	1	Shunt Regulator	-	±0.5%	TL431BIDBZT	TI	SOT-23-3
LF1	1	Line Filter	13mH	1A	XF1482Y	Alpha Trans	-
PC1	1	Optocoupler	-	5kV	LTV-817-B	LiteON	DIP4
T1	1	Transformer	-	Bobin:EI-2506, Core:EE25/20	XE2181A	Alpha Trans	-
R4	1	Resistor	0.43Ω	2W, ±1%	LTR100JZPFLR430	ROHM	3264 (1225)
R5	1	Resistor	5.6Ω	0.25W, ±5%	MCR18EZPJ5R6	ROHM	3216 (1206)
R6	1	Resistor	0Ω	0.25W	MCR18EZPJ000	ROHM	3216 (1206)
R7	1	Resistor	100kΩ	2W, 700V, ±2%	ERG2S104E	Panasonic	-
R10	1	Resistor	33kΩ	0.1W, ±1%	MCR03EZPFX3302	ROHM	1608 (0603)
R11	1	Resistor	5.6kΩ	0.1W, ±1%	MCR03EZPFX5601	ROHM	1608 (0603)
R12	1	Resistor	10kΩ	0.1W, ±1%	MCR03EZPFX1002	ROHM	1608 (0603)
R13	1	Resistor	2.2kΩ	0.1W, ±5%	MCR03EZPF222	ROHM	1608 (0603)
R14	1	Resistor	1kΩ	0.1W, ±5%	MCR03EZPJ102	ROHM	1608 (0603)
R15	1	Resistor	27kΩ	0.1W, ±5%	MCR03EZPJ273	ROHM	1608 (0603)
ZNR1	1	Varistor	-	300Vac, 423Vmin, 400A	V470ZA05P	Littelfuse	5mmΦ Disc

Design reference of transformer

Manufacturer : Alfatrans Co., LTD.
 〒541-0059 2-7-1 bakurou-cho, chu-o ku, osaka
<http://www.alphatrans.jp/>

Product: XE2181A AlphaTrans Corp.
 Bobin: EI-2506 10PIN
 Core: EE25/20 JSF

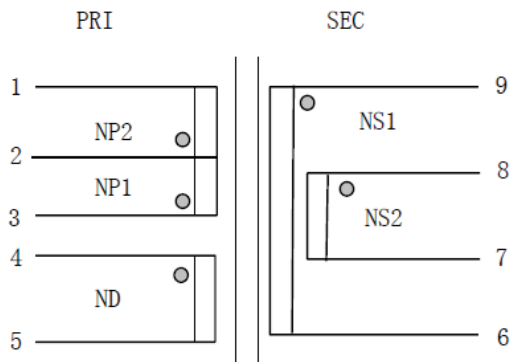

Figure 4. Connection Diagram

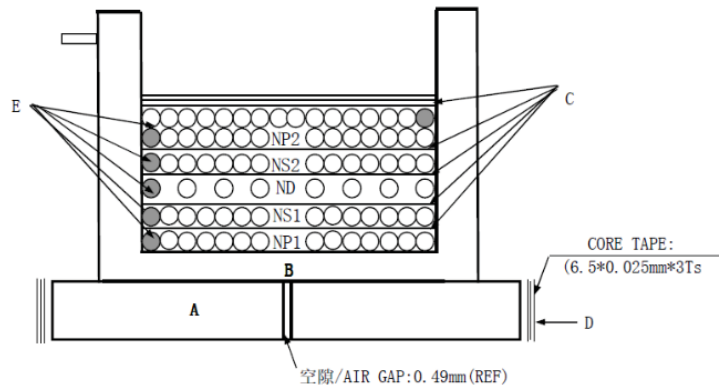

Figure 5. Winding structure diagram

Table 3. Alpha Trans XE2181A Winding Specification

NO.	WINDING	TERMINAL		WIRE SIZE	TURNS	TAPE LAYERS	WINDING METHOD	NOTE
		START	FINISH					
1	NP1	3	2	2UEW/Φ0.30mm*1	29	1	COMPACT	
2	NS1	9	6	TEX-E/Φ0.50m*1	14	1	COMPACT	
3	ND	4	5	2UEW/Φ0.15mm*1	18	1	SCATTER	
4	NS2	8	7	TEX-E/Φ0.50m*1	14	1	COMPACT	
5	NP2	2	1	2UEW/Φ0.30mm*1	48	3	COMPACT	

Inductance (Lp) 830μH± 15% (100kHz,1V)
 Leakage Inductance 25μH MAX
 Withstand Voltage Pri – Sec AC3000V
 Pri - Core AC1500V
 Sec – Core AC1500V
 Insulation resistance 100MΩ over (DC500V)

BM2P0161 Overview

Feature

- PWM Frequency=65kHz
- PWM current Mode Control
- Switching frequency jitter
- Burst function around light load
- Burst frequency control adjust (FADJ)
- 650 V Starter
- 650 V Power MOSFET
- VCC OVP, UVLO
- SOURCE Comparator Leading-Edge-Blanking
- Cycle by cycle current limiter
- Current limiter AC Voltage compensation circuit
- Soft Start function
- OLP、Thermal shut down

Key specifications

- Operation Voltage Range:
 - VCC: 8.9 V ~ 26.0 V
 - DRAIN: 650 V(Max)
- Circuit Current(ON) :
 - BM2P0161: 0.90 mA(Typ)
 - BM2P0361: 0.65 mA(Typ)
- Circuit Current (Burst mode) : 0.30 mA(Typ)
- Operating Temperature: -40 °C ~ +105 °C
- Maximum Junction Temperature : +150 °C
- MOSFET R-ON :
 - BM2P0161 : 1.0 Ω(Typ)
 - BM2P0361 : 3.0Ω(Typ)

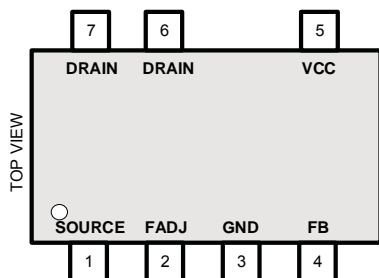

Figure 8. Block Diagram

Dimension

W(Typ) x D(Typ) x H(Max)
 DIP7K 9.20 mm x 6.35 mm x 4.30 mm
 Pitch 2.54 mm



Figure 9. DIP7K Package

Table 4. BM2P0161 PIN description

NO.	Name	I/O	Function	ESD Diode	
				VCC	GND
1	SOURCE	I/O	MOSFET SOURCE	✓	✓
2	FADJ	I	Max Burst Frequency Setting pin	✓	✓
3	GND	I/O	GND	✓	-
4	FB	I	Feedback signal input	✓	✓
5	VCC	I	Vcc	-	✓
6	DRAIN	I/O	MOSEFET DRAIN	-	-
7	DRAIN	I/O	MOSEFET DRAIN	-	-

Design Overview

1. Important parameter

- Input Voltage Spec AC90V to AC264V (DC 100V to 380V)
- MOSFET Voltage max 650V

1-1. Determination of fly-back voltage VOR

Turns-ratio $N_p:N_s$ and duty-ratio is determined along with Fly-back voltage VOR

$$VOR = VO \times \frac{N_p}{N_s} = \frac{ton}{toff} \times VIN$$

$$VOR = (650V \div 1.3) - VIN(max)$$

* 1.3: Safety margin. Please check yourself.

$$\frac{N_p}{N_s} = \frac{VOR}{VO}$$

$$Duty = \frac{VOR}{VIN + VOR}$$

$$VOR < (650 \div 1.3) - 380 = 120$$

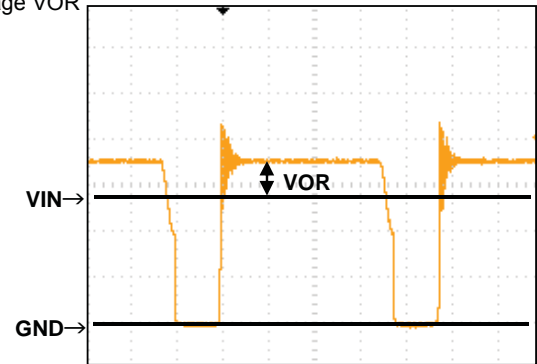

Figure 10. MOSFET Drain-Source Voltage (Vds)

Confirmation of N_p/N_s and Duty (max)

$$VOR = 70V < (650 \div 1.3) - 380 = 120$$

VIN (MIN) =100V, VOR=70V, Vf=1V

$$\frac{N_p}{N_s} = \frac{VOR}{VO} = \frac{VOR}{Vout + Vf} = \frac{70V}{12V + 1V} = 5.38$$

(*) VOR should be set to keep margin from input Max voltage plus VOR and MOSFET maximum ratings.

And VOR setting also keep MOSFET on duty within 0.5 at input voltage minimum.

$$\frac{N_p}{N_s} = \frac{VOR}{VO} = \frac{VOR}{Vout + Vf} = \frac{70V}{12V + 1V} = 5.38$$

$$Duty(max) = \frac{VOR}{VIN(min) + VOR} = \frac{70V}{100V + 70V} = 0.412$$

1-2. Selecting operation mode

Flyback converter of fixed frequency PWM switching send power from primary side to secondary side using Transformer. Transformer operation mode are blow three modes.

- CCM (Continuous Current Mode) Primary MOSFET turn ON before secondary coil discharge complete.
- BCM (Boundary Current Mode) Primary MOSFET turn ON timing is just secondary coil discharge. Mode name from looks like bounding ball, secondary current wave form touch to GND at the same time primary coil current grow-up from GND.
- DCM (Dis-continuous Current Mode) Primary MOSFET turn ON timing has some interval after secondary coil discharge. Coil current is dis-continue.

BM2P0161 can be operate CCM, BCM and DCM.

This reference board transformer design target is BCM point at input DC260V (185V) and LOAD 12V/2A.

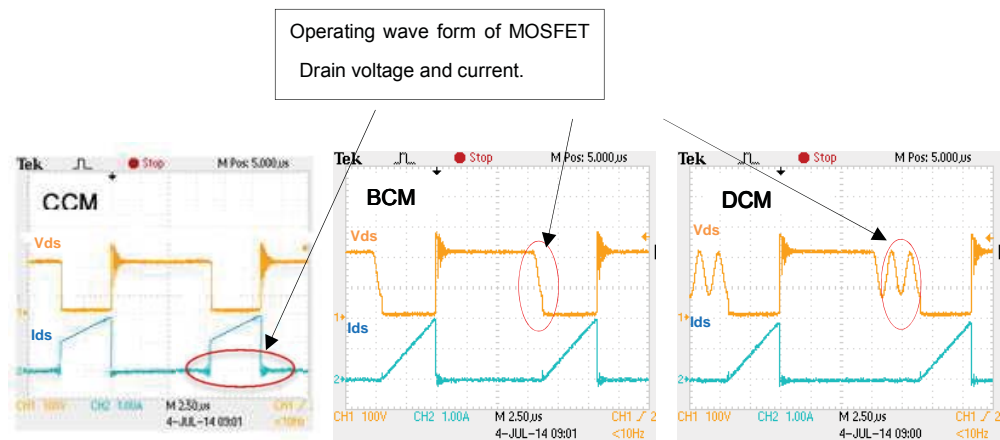

Figure 11. Switching waveform (MOSFET Vds, Ids)

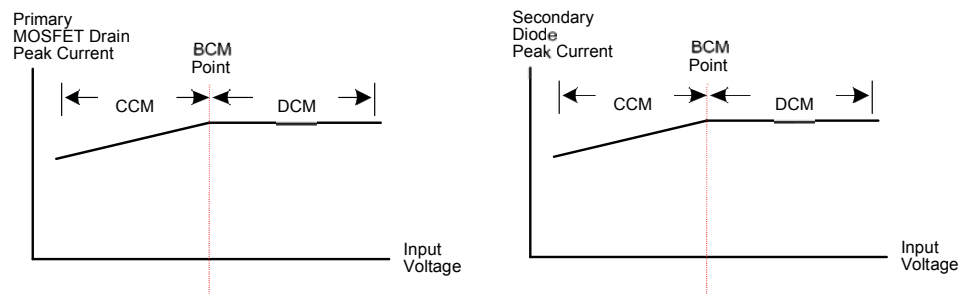

Figure 12. Operation mode – Input Voltage and Peak current (MOSFET Drain, Diode)

1-3. Design of transformer inductances

Assuming condition BCM point is 260VDC, 65kHz 12V/2A load.

Calculation for secondary and primary inductance, peak current.

Vo=12V, secondary rectifier diode VF = 1V

$$Po = (12V + 1V) \times 2A = 26W$$

$$Duty = \frac{VOR}{VIN + VOR} = \frac{70V}{260V + 70V} = 0.212$$

$$Ls = \frac{(Vo \times (1 - Duty)^2)}{(2 \times Io(max) \times fsw)} = ((12V + 1V) \times \frac{(1 - 0.212)^2}{2 \times 2A \times 65k}) = 28.555\mu H$$

$$Lp = Ls \times (\frac{Np}{Ns})^2 = 0.28555\mu H \times 5.38^2 = 0.83mH$$

$$Ispk = \sqrt{\frac{2 \times Po(max)}{Ls \times fsw}} = 5.3A$$

$$Ippk = \sqrt{\frac{2 \times Po(max)}{Lp \times fsw}} = 0.982A$$

$$Ipav = Ippk \times \frac{Duty}{\sqrt{3}} = 0.982 \times \frac{0.212}{\sqrt{3}} = 0.12A$$

1-4. Selecting transformer core size

Accordingly Po (max) =26W, Core is selected EE25.

Table 5. Output Power vs transformer core size

Output Power Po(W)	Core Size	Core Area Ae (mm ²)
~30	EI25/EE25	41
~60	EI28/EE28/EER28	84
~80	EI33/EER35	107

(*) above table is one of reference, please confirmation to transformer manufacturer.

1-5. Calculate of primary wiring turn : Np

The maximum rating of magnetic flux density of standard ferrite core is

0.4T@100°C. Accordingly Bsat=0.266T.

$$Np > \frac{Lp \times Ippk}{Ae \times Bsat} = \frac{830\mu H \times 0.982A}{40mm^2 \times 0.266T} = 76.6turns$$

Np makes 77 turns.

Prevent form Magnetic saturation.

Check transformer AL-Value – NI value table.

When Np=77 turns,

$$AL - Value = \frac{Np}{Np^2} = \frac{830\mu H}{77turns^2} = 139nH/turns^2$$

$$NI = Np \times Ippk = 77turns \times 0.982A = 75.62A \cdot turns$$

Confirm by core specification whether or not it falls into this saturation region.

NI limit vs. AL-value
PC47EE25/19

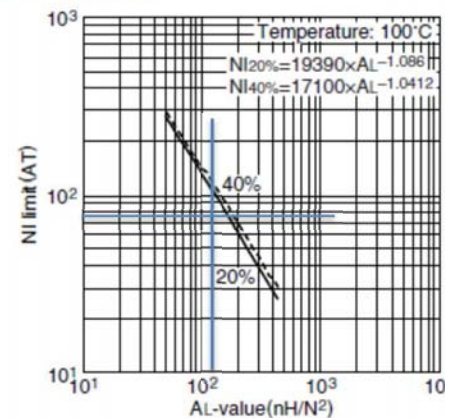

Figure 13. TDK PC47EE25/19

AL-Value to NI Limit

1-6. Calculate of secondary wiring turn : Ns

$$\frac{N_p}{N_s} = 5.38 \rightarrow N_s = \frac{77}{5.38} = 4.31 \text{turns}$$

Ns wiring is 14 turns.

Secondary wiring average current is output current.

1-7. Calculation of VCC wiring turn ; Nd

Accumulation VCC=16V, Vf_vcc diode =1V

$$N_d = N_s \times \frac{V_{CC} + V_{f_vcc}}{V_{out} + V_f} = 14 \text{turns} \times \frac{16V + 1V}{12V + 1V} = 18.3 \text{turns}$$

Nd wiring is 18 turns.

(*) Please consider secondary capacitor voltage ratings and VCC OVP voltage.

Transformer parameter of this section result.

Table 6. Transformer parameter table

Core	PC47EE25/19 compatible
Lp	830μH
Np	77 turns
Ns	14 turns
Nd	18 turns

2. Selection of important components

2-1. Input capacitor ; C5

Calculation by using of Table 1-3

$$P_{out} = 12V \times 2.0A = 24W, C_5 : 2 \times 24 = 48 \rightarrow 47\mu F$$

Table 7. Input capacitor selection table

Input Voltage (Vdc)	Cin (μF)
< 300	2 x Pout(W)
300<	1 x Pout(W)

(*) When selecting, also consider other specifications such as the output retention-time.

Capacitor voltage rating is selected by maximum input voltage.

This time we selected 450V ratings capacitor.

2-2. Current sensing resistor ; R4

The current-sensing resistor and current limiter is set maximum output power.

$$R4 = \frac{V_{cs} + 20mV \times (duty/fsw)}{I_{ppk}} = \frac{0.4V + 0.02V \times (0.212/65000) \times 10^6}{0.982A} = 0.473$$

R4 is selected 0.43Ω.

Calculation of R4 power loss

$$P_{R4(\text{peak})} = I_{ppk}^2 \times R4 = 0.982^2 A \times 0.43\Omega = 0.415W$$

$$P_{R4(\text{rms})} = I_{pav} \times R4 = 0.212A \times 0.43\Omega = 0.0912W$$

Set the value 1W or above in consideration of pulse resistance.

The structure of the resistance may vary the pulse resistance even with the same power rating.

Check with the resistor manufacturers for details.

2-3. VCC diode ; D2

A high-speed diode (Small size rectifier or fast recovery diode) is recommended as the VCC-diode.

Diode current is only IC current, its maximum value is around 15mA.

When D2_Vf=1V, reverse voltage applied to the VCC-diode:

$$V_{dr} = V_{CC(\text{max})} + V_f + V_{IN(\text{max})} \times \frac{N_d}{N_p}$$

This IC has VCC OVP function, VCC OVP (max) =29.0V.

Reverse voltage of the diode is set so as not to exceed the Vr of diode in conditions of VCC OVP (max).

$$V_{dr} = 29V + 1.0V + 400V \times \frac{14\text{turns}}{77\text{turns}} = 103V$$

With a design-margin taken into account, selected RRE02VSM4S 0.2A/400V

2-4. VCC winding surge-voltage limiting resistor ; R5

Based on the transformer's leakage inductance (Lleak), a large surge-voltage (spike noise) may occur during the instant when the MOSFET is switched from ON to OFF. This surge-voltage is induced in the VCC winding, and as the VCC voltage increases the IC's VCC overvoltage protection may be triggered.

A limiting resistor R5 (approximately 5Ω to 22Ω) is inserted to reduce the surge-voltage that is induced in the VCC winding.

Confirm the rise in VCC voltage while the resistor is assembled in the product.

2-5. VCC capacitor ; C10

This IC is built-in starter. Therefore start up time is from VCC capacitor value. Starting time is bellows.

After start up. Consumption power is determined by idling current Istart3.

Capacitor Rating voltage setting is over and margin from VCC OVP voltage =29Vmax.

This board selecting value is 10uF/50V.

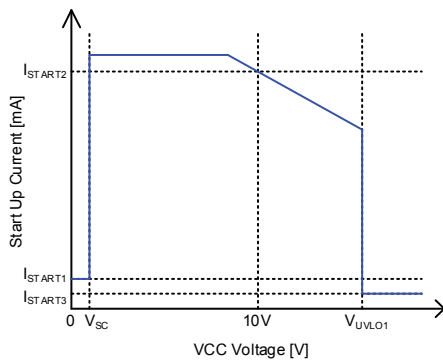

Figure 14. Start Up Current vs VCC Voltage

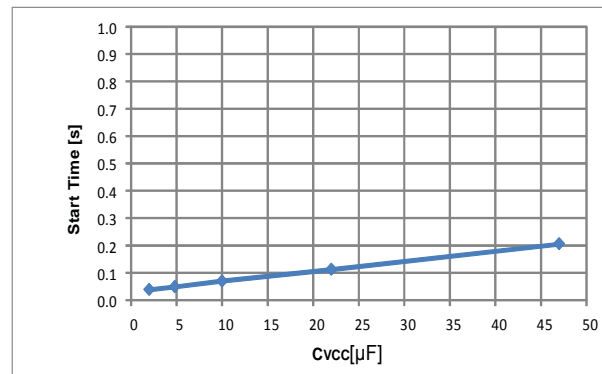

Figure 15. Start Time vs C_{VCC}

2-6. Snubber circuit ; C6,D1,R7

Based on the transformer's leakage inductance (Lleak), a large surge-voltage (spike noise) may occur during the instant when the MOSFET is switched from ON to OFF. This surge-voltage is applied between the MOSFET's Drain and Source, so in the worst case damage to MOSFET might occur. RCD snubber circuits are recommended to suppress this surge-voltage.

(1) Determination of clamp voltage (Vclamp) and clamp ripple-voltage (Vripple)

The clamp voltage is determined by the MOSFET's withstand voltage considering a design margin.

$$V_{clamp} = 650V \times 0.8 = 520V$$

Clamp voltage Ripple(Vripple) is set about 70V

(2) Determination of R7

R7 is selected according to the following conditions. (Consideration margin)

$$\text{Assumption } L_{leak} = L_p \times 5\% = 830\mu H \times 5\% = 42\mu H$$

$$R7 < 2 \times V_{clamp} \times \frac{V_{clamp} - V_{OR}}{L_{leak} \times I_p^2 \times f_{sw}} = 2 \times 520V \times \frac{520V - 70V}{42\mu \times 0.982^2 \times 65k} = 178k\Omega$$

R7 is selected 120kΩ.

R7 Power loss ; P_{R7}

$$P_{R7} = \frac{(V_{clamp} - V_{IN})^2}{R7} = \frac{(520 - 400)^2}{120k} = 0.12W$$

P_{R7} is setting 1W including some margins.

(3) Determination of C6

$$C6 > \frac{V_{clamp}}{V_{ripple} \times f_{sw} \times R7} = \frac{520V}{70V \times 65kHz \times 120k\Omega} = 935pF$$

C6 voltage is VOR- input maximum voltage 520V-400=120V + surge

This time capacitor value and voltage rating is set 1000pF/1kV. Considering surge voltage margins.

(4) Determination of D1

Choose a fast recovery diode as the diode, with a withstand voltage that is at or above the MOSFET's Vds (max) value.

This time is selected RFN1LAM7S 0.8A/700V.

2-7. FB terminal capacitor:C9

C16 is a capacitor for stability of FB voltage (approximately 1000pF to 0.01μF)

2-8. Output rectification diode :D3

Choose a high-speed diode (Schottky barrier diode or fast recovery diode) as the output rectification diode. When Vf=1V, reverse voltage applied to output diode is,

$$V_{dr} = V_{out(max)} + v_f + V_{IN(max)} \times \frac{N_s}{N_p}$$

When Vout(max)=12.0V+10%=13.2V

$$V_{dr} = 13.2V + 1.0V + 400V \times \frac{14}{77} = 86.92V$$

With consideration of margins 87/0.7=124V → 150V

Also, diode loss (approximate value) becomes Pd=Vf x Iout=1.0V x 2A=2.0W

This board is used schottky barrier diode RB088BGE-150 : 150V 10A , TO-252 package

Using a voltage margin of 70% or less and current of 50% or less is recommended.

Check the rise in temperature while assembled in the product. If necessary, reconsider the component and radiate heat by a heat sink or similar to dissipate the heat.

2-9. Output capacitors: C13, C15

Determine the output capacitors based on the output load's allowable peak-to-peak ripple voltage (ΔVpp) and ripple-current. When the MOSFET is ON, the output diode is OFF. At that time, current is supplied to the load from the output capacitors. When the MOSFET is OFF, the output diode is ON. At that time, the output capacitors are charged and a load current is also supplied.

When ΔVpp = 200mV,

$$Z_c < \frac{\Delta V_{pp}}{I_{spk}} = \frac{\Delta V_{pp}}{\frac{N_p}{N_s} \times I_{ppk}} = \frac{0.2V}{\frac{77}{14} \times 0.982A} = 0.037\Omega \quad \text{at } 60kHz: f_{sw}(\text{min})$$

With an ordinary switching power supply electrolytic-capacitor (low-impedance component), impedance is rated at 100kHz, so it is converted to 100kHz.

$$Z_c < 0.037\Omega \times \frac{65}{100} = 0.02405\Omega \quad \text{at } 100kHz$$

Ripple Current I_s (rms) is

$$I_s(\text{rms}) = I_{\text{spk}} \times \sqrt{\frac{1 - \text{Duty}}{3}} = \frac{77}{14} \times 0.982A \times \sqrt{\frac{1 - 0.212}{3}} = 2.768A$$

C13 charge/Discharge Current I_c (rms) is

$$I_c(\text{rms}) = \sqrt{I_s(\text{rms})^2 - I_o^2} = \sqrt{2.768^2 - 2^2} = 1.91A(\text{rms})$$

The capacitor's withstand voltage should be set to about twice the output voltage.

$$V_{\text{out}} \times 2 = 12V \times 2 = 24V \rightarrow \text{over } 25V$$

Select an electrolytic capacitor that is suitable for these conditions.

The board is select capacitor as bellows.

C13 1000uF/25V Rubycon ZLJ Series Iripple 2500mA@100kHz Imp 0.028Ω

C15 0.1uF/50V Ceramic Capacitor

(*) Use the actual equipment to check the actual ripple-voltage, ripple-current and capacitor-current.

2-10. Output voltage setting resistors: R10,R11,R12

Set the output voltage with the following formal

When Shunt regulator IC2: $V_{\text{ref}}=2.495V$,

$$V_o = \left(1 + \frac{R10 + R11}{R12}\right) \times V_{\text{ref}} = \left(1 + \frac{33k\Omega + 5.6k\Omega}{10k\Omega}\right) \times 2.495V = 12.1257V$$

2-11. Parts for adjustment of control circuit:R15, C16, R13, R14

R15 and C11 are parts for phase compensation. Approximately R15:1k to 30kΩ, C11=0.1uF, and adjust them while they are assembled in the product.

R13 is a resistor which limits a control circuit current. Approximately R14:300 to 2kΩ, and adjust it while it assembled in the product. R14 is a resistor for adjustment of minimum operating current of shunt regulator IC2.

In case of IC2: TL431, minimum operating current is 1mA. And when Optocoupler:PC1_Vf is 1V, $R14 = 1V / 1mA = 1k\Omega$

3. EMI Measure

Confirm the following with regard to EMI countermeasures.

(*) Constants are reference values. Need to be adjusted based on noise effects.

- Addition of filter to input block C1, C2, LF1
- Addition of capacitor between primary-side and secondary-side (approximately C11: Y-Cap 2200pF)
- Addition of RC snubber to secondary diode

Measurement DATA

Constant Load Regulations

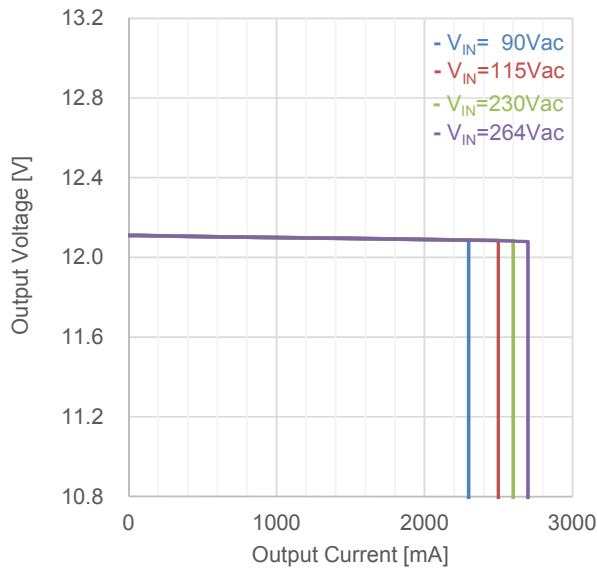

Figure 16. Load Regulation (I_{OUT} vs. V_{OUT})

Table 8. Load Regulation ($V_{IN}=90Vac$)

I_{OUT}	V_{OUT}	Efficiency
500 mA	12.105 V	85.13 %
1000 mA	12.100 V	85.75 %
1500 mA	12.096 V	85.58 %
2000 mA	12.090 V	84.75 %

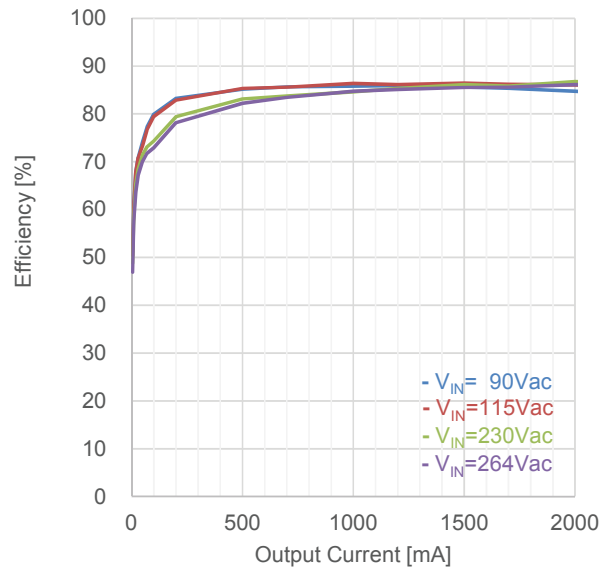

Figure 17. Load Regulation (I_{OUT} vs. Efficiency)

Table 9. Load Regulation ($V_{IN}=230Vac$)

I_{OUT}	V_{OUT}	Efficiency
500 mA	12.105 V	83.14 %
1000 mA	12.100 V	84.62 %
1500 mA	12.095 V	86.11 %
2000 mA	12.090 V	86.73 %

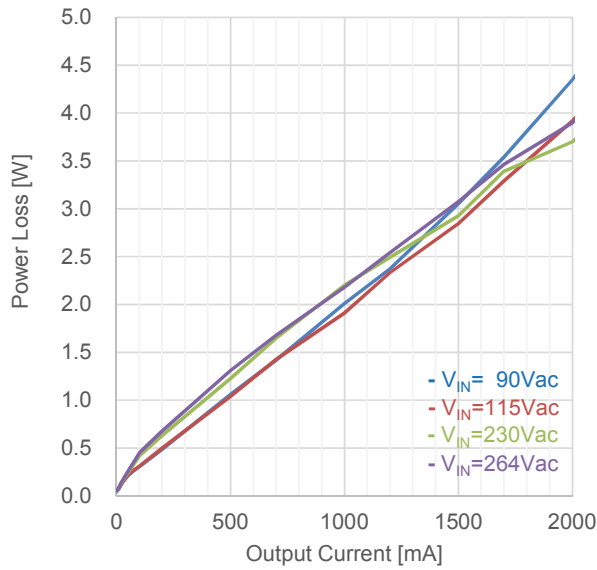

Figure 18. Load Regulation (I_{OUT} vs. P_{LOSS})

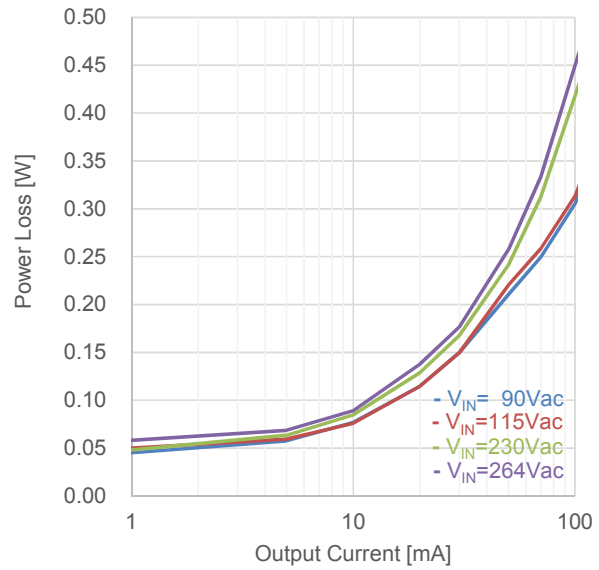

Figure 19. Load Regulation (I_{OUT} vs. P_{LOSS})

Table 10. Load Regulation : V_{IN}=90Vac

V _{IN} [Vac]	P _{IN} [W]	V _{OUT} [V]	I _{OUT} [mA]	P _{OUT} [W]	P _{LOSS} [W]	Efficiency [%]
90	0.04	12.110	0	0.00	0.042	0.00
90	0.12	12.110	5	0.06	0.057	51.31
90	0.20	12.110	10	0.12	0.077	61.16
90	0.36	12.110	20	0.24	0.115	67.84
90	0.51	12.110	30	0.36	0.150	70.82
90	0.82	12.110	50	0.61	0.211	74.20
90	1.10	12.109	70	0.85	0.249	77.27
90	1.52	12.109	100	1.21	0.305	79.87
90	2.91	12.108	200	2.42	0.486	83.27
90	7.11	12.105	500	6.05	1.058	85.13
90	9.89	12.103	700	8.47	1.418	85.66
90	14.11	12.100	1000	12.10	2.010	85.75
90	16.89	12.098	1200	14.52	2.372	85.95
90	21.20	12.096	1500	18.14	3.056	85.58
90	24.10	12.094	1700	20.56	3.540	85.31
90	28.53	12.090	2000	24.18	4.350	84.75
90	33.13	12.088	2300	27.80	5.328	83.92
90	OLP	0.000	2300			

Table 11. Load Regulation: V_{IN}=115Vac

V _{IN} [Vac]	P _{IN} [W]	V _{OUT} [V]	I _{OUT} [mA]	P _{OUT} [W]	P _{LOSS} [W]	Efficiency [%]
115	0.05	12.110	0	0.00	0.047	0.00
115	0.12	12.110	5	0.06	0.059	50.46
115	0.20	12.110	10	0.12	0.076	61.47
115	0.36	12.110	20	0.24	0.115	67.84
115	0.51	12.110	30	0.36	0.150	70.82
115	0.83	12.110	50	0.61	0.221	73.31
115	1.11	12.109	70	0.85	0.258	76.64
115	1.52	12.109	100	1.21	0.313	79.46
115	2.92	12.108	200	2.42	0.499	82.90
115	7.09	12.105	500	6.05	1.038	85.37
115	9.90	12.103	700	8.47	1.428	85.58
115	14.01	12.100	1000	12.10	1.910	86.37
115	16.85	12.098	1200	14.52	2.332	86.16
115	20.99	12.096	1500	18.14	2.846	86.44
115	23.85	12.094	1700	20.56	3.290	86.20
115	28.10	12.091	2000	24.18	3.918	86.06
115	35.37	12.085	2500	30.21	5.158	85.42
115	OLP	0.000	2500			

Table 12. Load Regulation : V_{IN}=132Vac

V _{IN} [Vac]	P _{IN} [W]	V _{OUT} [V]	I _{OUT} [mA]	P _{OUT} [W]	P _{LOSS} [W]	Efficiency [%]
132	0.04	12.110	0	0.00	0.043	0.00
132	0.12	12.110	5	0.06	0.063	48.83
132	0.20	12.110	10	0.12	0.074	62.10
132	0.36	12.110	20	0.24	0.116	67.65
132	0.51	12.110	30	0.36	0.151	70.68
132	0.83	12.110	50	0.61	0.225	72.95
132	1.12	12.109	70	0.85	0.270	75.82
132	1.54	12.109	100	1.21	0.326	78.78
132	2.94	12.108	200	2.42	0.518	82.37
132	7.12	12.105	500	6.05	1.068	85.01
132	9.85	12.103	700	8.47	1.378	86.01
132	14.06	12.100	1000	12.10	1.960	86.06
132	16.78	12.098	1200	14.52	2.262	86.52
132	20.88	12.096	1500	18.14	2.736	86.90
132	23.76	12.094	1700	20.56	3.200	86.53
132	27.99	12.090	2000	24.18	3.810	86.39
132	35.13	12.084	2500	30.21	4.920	85.99
132	OLP	0.000	2500			

Table 13. Load Regulation: V_{IN}=176Vac

V _{IN} [Vac]	P _{IN} [W]	V _{OUT} [V]	I _{OUT} [mA]	P _{OUT} [W]	P _{LOSS} [W]	Efficiency [%]
176	0.04	12.110	0	0.00	0.039	0.00
176	0.12	12.110	5	0.06	0.057	51.31
176	0.20	12.110	10	0.12	0.078	60.85
176	0.36	12.110	20	0.24	0.121	66.72
176	0.52	12.110	30	0.36	0.157	69.87
176	0.83	12.109	50	0.61	0.226	72.86
176	1.15	12.109	70	0.85	0.300	73.84
176	1.58	12.109	100	1.21	0.364	76.88
176	2.98	12.108	200	2.42	0.561	81.18
176	7.19	12.105	500	6.05	1.138	84.18
176	9.95	12.103	700	8.47	1.478	85.15
176	14.05	12.100	1000	12.10	1.950	86.12
176	16.89	12.098	1200	14.52	2.372	85.95
176	21.02	12.095	1500	18.14	2.878	86.31
176	23.67	12.093	1700	20.56	3.112	86.85
176	27.92	12.090	2000	24.18	3.740	86.60
176	34.94	12.085	2500	30.21	4.728	86.47
176	36.35	12.084	2600	31.42	4.932	86.43
176	OLP	0.000	2600			

Table 14. Load Regulation : V_{IN}=230Vac

V _{IN} [Vac]	P _{IN} [W]	V _{OUT} [V]	I _{OUT} [mA]	P _{OUT} [W]	P _{LOSS} [W]	Efficiency [%]
230	0.05	12.110	0	0.000	0.045	0.00
230	0.12	12.110	5	0.061	0.063	48.83
230	0.21	12.110	10	0.121	0.085	58.79
230	0.37	12.110	20	0.242	0.129	65.28
230	0.53	12.110	30	0.363	0.168	68.42
230	0.85	12.110	50	0.606	0.242	71.49
230	1.16	12.109	70	0.848	0.312	73.07
230	1.63	12.109	100	1.211	0.418	74.33
230	3.05	12.108	200	2.422	0.629	79.37
230	7.28	12.105	500	6.053	1.228	83.14
230	10.12	12.103	700	8.472	1.648	83.72
230	14.30	12.100	1000	12.100	2.200	84.62
230	17.01	12.098	1200	14.518	2.492	85.35
230	21.07	12.095	1500	18.143	2.928	86.11
230	23.95	12.093	1700	20.558	3.392	85.84
230	27.88	12.090	2000	24.180	3.700	86.73
230	35.02	12.085	2500	30.213	4.808	86.27
230	36.43	12.084	2600	31.418	5.012	86.24
	OLP	0.000	2600			

Table 15. Load Regulation: V_{IN}=264Vac

V _{IN} [Vac]	P _{IN} [W]	V _{OUT} [V]	I _{OUT} [mA]	P _{OUT} [W]	P _{LOSS} [W]	Efficiency [%]
264	0.06	12.110	0	0.00	0.055	0.06
264	0.13	12.110	5	0.06	0.068	0.07
264	0.21	12.110	10	0.12	0.089	0.09
264	0.38	12.110	20	0.24	0.138	0.14
264	0.54	12.110	30	0.36	0.177	0.18
264	0.86	12.110	50	0.61	0.258	0.26
264	1.18	12.109	70	0.85	0.333	0.33
264	1.66	12.109	100	1.21	0.450	0.45
264	3.10	12.108	200	2.42	0.675	0.68
264	7.36	12.105	500	6.05	1.312	1.31
264	10.15	12.103	700	8.47	1.678	1.68
264	14.28	12.100	1000	12.10	2.180	2.18
264	17.06	12.098	1200	14.52	2.542	2.54
264	21.22	12.095	1500	18.14	3.078	3.08
264	24.02	12.093	1700	20.56	3.462	3.46
264	28.08	12.090	2000	24.18	3.900	3.90
264	35.19	12.084	2500	30.21	4.980	4.98
264	38.00	12.080	2700	32.62	5.384	5.38
264	OLP	0.000	2700			

• Switching Frequency

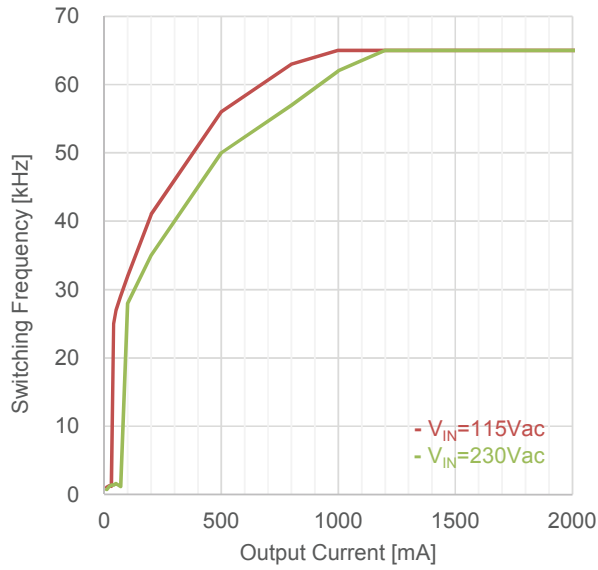

Figure 20. Switching Frequency (I_{OUT} vs. F_{SW})

• Primary Peak Current

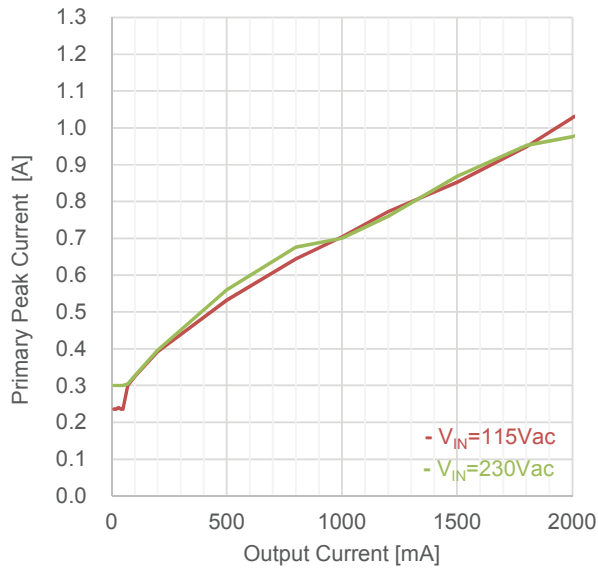

Figure 21. Primary Peak Current (I_{OUT} vs. I_{PPEAK})

• Secondary Peak Current

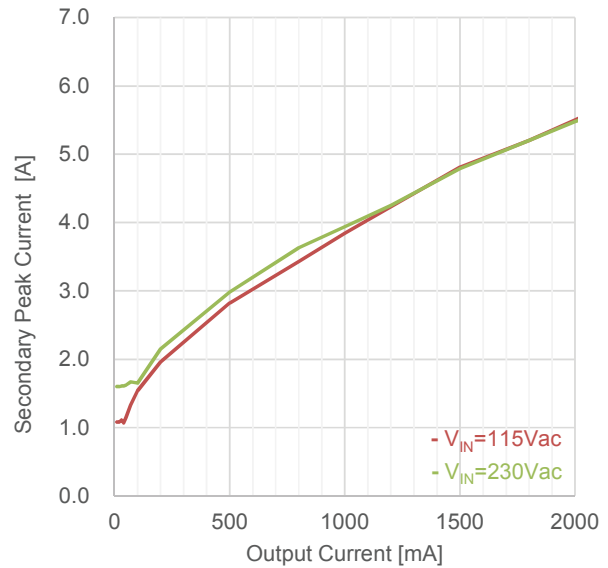

Figure 22. Primary Peak Current (I_{OUT} vs. I_{SPEAK})

• Operation Waveform

CH3 Purple MOSFET VDS
 CH2 Blue MOSFET IDrain
 CH4 Green Secondary Diode Vr
 CH1 Yellow Secondary Diode If

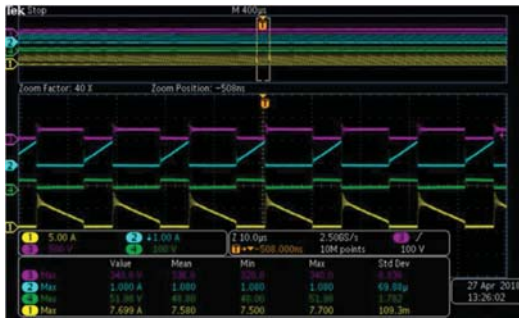

Figure 23. $V_{IN}=90Vac$, $I_{OUT}=2A$



Figure 24. $V_{IN}=90Vac$ Output Short

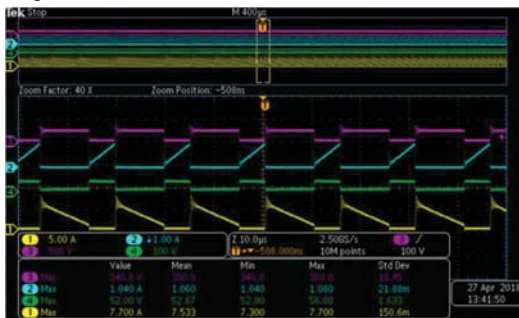

Figure 25. $V_{IN}=115Vac$, $I_{OUT}=2A$



Figure 26. $V_{IN}=115Vac$ Output Short

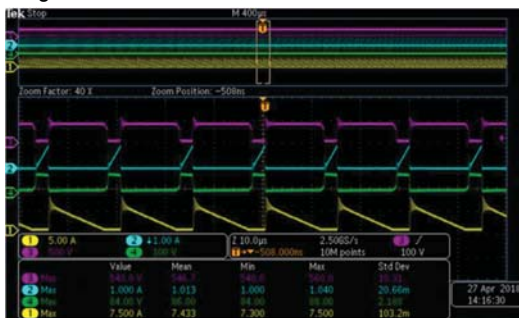

Figure 27. $V_{IN}=230Vac$, $I_{OUT}=2A$



Figure 28. $V_{IN}=230Vac$ Output Short

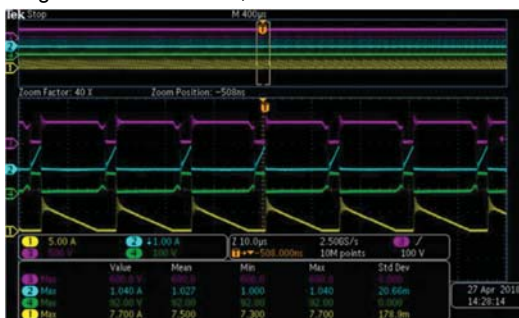

Figure 29. $V_{IN}=264Vac$, $I_{OUT}=2A$



Figure 30. $V_{IN}=264Vac$ Output Short

• Power ON

CH4 Green	AC Input Voltage	5V/div
CH1 Yellow	VCC Voltage	10msec/div
CH3 Purple	Output Voltage	
Horizontal		



Figure 31. $V_{IN}=115Vac$, $R_{OUT}=12\Omega$

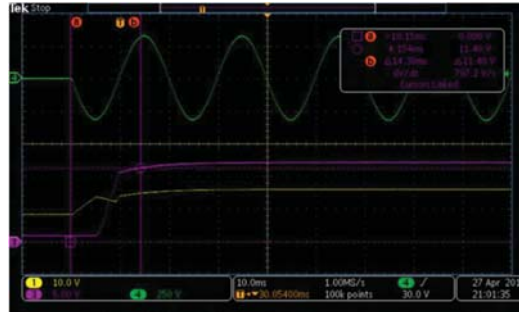

Figure 32. $V_{IN}=264Vac$, $R_{OUT}=12\Omega$

• Dynamic Response

CH1 Yellow	Output Voltage	200mV/div
CH2 Blue	Output Current	1A/div
Horizontal		2msec/div

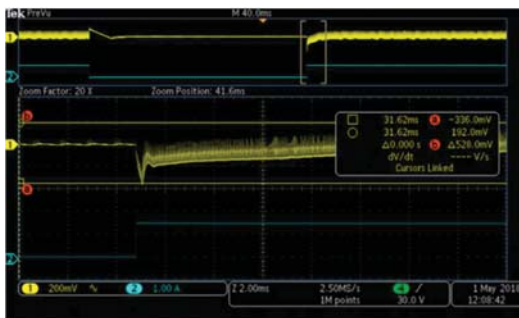

Figure 33. $V_{IN}=115Vac$, $I_{OUT}=10mA$ to 1500mA

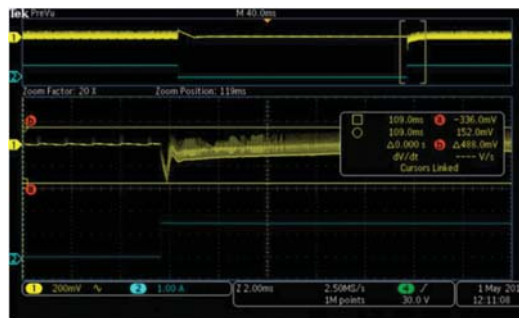

Figure 34. $V_{IN}=230Vac$, $I_{OUT}=10mA$ to 1500mA

• Output ripple Voltage

CH1 Yellow	Output Voltage	200mV/div
Horizontal		8μsec/div

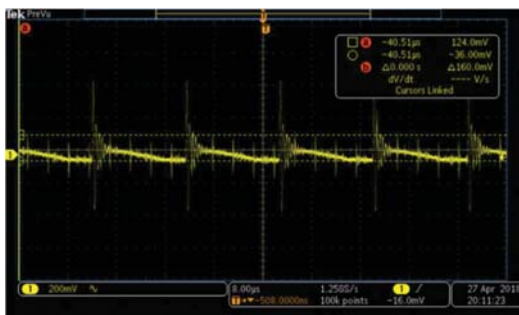

Figure 35. $V_{IN}=115Vac$, $I_{OUT}=2A$

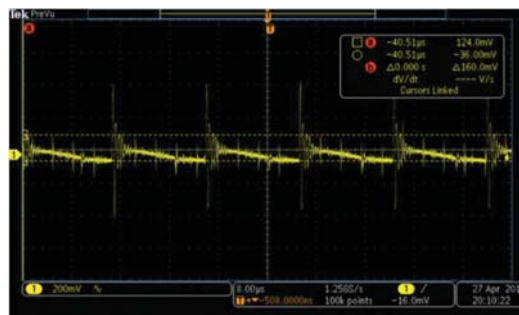

Figure 36. $V_{IN}=230Vac$, $I_{OUT}=2A$

• Operating Temperature

The Results were measured 30 minutes after startup.

Table 16. Operating Temperature by Evaluation Board (Ta:room)

Part	Condition			
	V _{IN} =90Vac		V _{IN} =230Vac	
	I _{OUT} =1.5A	I _{OUT} =2A	I _{OUT} =1.5A	I _{OUT} =2A
BM2P0161	65.3°C	82.3°C	68.1°C	71.5°C
Transformer	58.1°C	72.3°C	66.6°C	73.4°C
2 ND Diode	68.7°C	80.6°C	68.6°C	78.4°C
Diode bridge	62.3°C	70.4°C	44.5°C	48.7°C
Snubber R	56.2°C	64.6°C	61.6°C	64.5°C
Input FL	36.7°C	46.0°C	31.6°C	37.0°C

• EMI

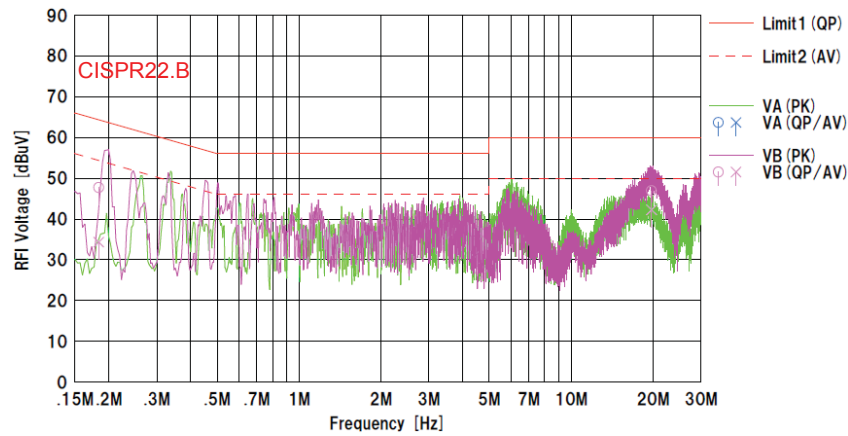

Figure 37. V_{IN}=230Vac/50Hz, I_{OUT}=2A
QP margin= 13.1dB, AV margin=7.8dB

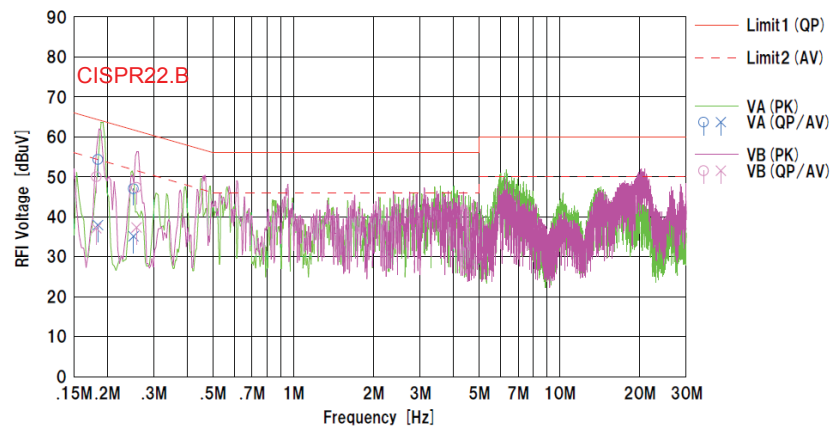

Figure 38. V_{IN}=230Vac/50Hz, I_{OUT}=2A
QP margin= 9.9dB, AV margin=16.3dB

Notes

- 1) The information contained herein is subject to change without notice.
- 2) Before you use our Products, please contact our sales representative and verify the latest specifications :
- 3) Although ROHM is continuously working to improve product reliability and quality, semiconductors can break down and malfunction due to various factors.
Therefore, in order to prevent personal injury or fire arising from failure, please take safety measures such as complying with the derating characteristics, implementing redundant and fire prevention designs, and utilizing backups and fail-safe procedures. ROHM shall have no responsibility for any damages arising out of the use of our Products beyond the rating specified by ROHM.
- 4) Examples of application circuits, circuit constants and any other information contained herein are provided only to illustrate the standard usage and operations of the Products. The peripheral conditions must be taken into account when designing circuits for mass production.
- 5) The technical information specified herein is intended only to show the typical functions of and examples of application circuits for the Products. ROHM does not grant you, explicitly or implicitly, any license to use or exercise intellectual property or other rights held by ROHM or any other parties. ROHM shall have no responsibility whatsoever for any dispute arising out of the use of such technical information.
- 6) The Products specified in this document are not designed to be radiation tolerant.
- 7) For use of our Products in applications requiring a high degree of reliability (as exemplified below), please contact and consult with a ROHM representative : transportation equipment (i.e. cars, ships, trains), primary communication equipment, traffic lights, fire/crime prevention, safety equipment, medical systems, servers, solar cells, and power transmission systems.
- 8) Do not use our Products in applications requiring extremely high reliability, such as aerospace equipment, nuclear power control systems, and submarine repeaters.
- 9) ROHM shall have no responsibility for any damages or injury arising from non-compliance with the recommended usage conditions and specifications contained herein.
- 10) ROHM has used reasonable care to ensure the accuracy of the information contained in this document. However, ROHM does not warrants that such information is error-free, and ROHM shall have no responsibility for any damages arising from any inaccuracy or misprint of such information.
- 11) Please use the Products in accordance with any applicable environmental laws and regulations, such as the RoHS Directive. For more details, including RoHS compatibility, please contact a ROHM sales office. ROHM shall have no responsibility for any damages or losses resulting non-compliance with any applicable laws or regulations.
- 12) When providing our Products and technologies contained in this document to other countries, you must abide by the procedures and provisions stipulated in all applicable export laws and regulations, including without limitation the US Export Administration Regulations and the Foreign Exchange and Foreign Trade Act.
- 13) This document, in part or in whole, may not be reprinted or reproduced without prior consent of ROHM.



Thank you for your accessing to ROHM product informations.
More detail product informations and catalogs are available, please contact us.

ROHM Customer Support System

<http://www.rohm.com/contact/>