

+12 to +32 dBm

Limiter

CLM-83-2W+

50Ω Broadband 30 to 8200 MHz

The Big Deal

- Ultra wide frequency range, 30 MHz to 8.2 GHz
- High CW input power, +32 dBm
- Ultra reliable ceramic hermetic package
- Low profile case, 0.045" high



CASE STYLE: DL1721

MIL Screening Available
Please consult Applications Dept.

Product Overview

The CLM-83-2W+ protects against ESD and input RF power surges, up to 1.6 W, across a very wide frequency range. Internal diodes are bonded to a multilayer integrated LTCC substrate, and then hermetically sealed under a controlled nitrogen atmosphere with gold-plated covers and eutectic AuSn solder. These rugged, tiny limiters, only 0.12 x 0.12 x 0.045" high, provide excellent protection for low noise amplifiers and other sensitive equipment, especially in hostile environments where unwanted signals prevail, such as manufacturing sites, train tunnels, ECM & ECCM, etc. This limiter is capable of meeting MIL requirements for gross leak, fine leak, thermal shock, vibration, acceleration, mechanical shock, and HTOL. The testing can be done if requested.

Key Features

Feature	Advantages
Limiting abilities from +12 to +32 dBm	Protects against very strong undesired signals to help prevent burn out of amplifiers and other highly sensitive components
Ultra wideband, 30 MHz to 8.2 GHz	Protects against many different types of unwanted signals.
Tiny surface mount package	Useful in crowded PCB boards where space is at a premium
Ceramic, hermetic, nitrogen filled construction	Protects against moisture, for long term reliability
Response time 2 nsec	Reacts almost instantaneously to limit unwanted high level signals
Recovery time 8 nsec	Minimal downtime after unwanted signals are removed, with very quick restoration of standard operating levels
Low insertion loss and VSWR	Provides minimal degradation to system performance, especially low noise amplifiers where input loss is critical
Low cost	Practical, low cost solution to protect expensive amplifiers or other sensitive applications from burning out

Notes

- A. Performance and quality attributes and conditions not expressly stated in this specification document are intended to be excluded and do not form a part of this specification document.
B. Electrical specifications and performance data contained in this specification document are based on Mini-Circuit's applicable established test performance criteria and measurement instructions.
C. The parts covered by this specification document are subject to Mini-Circuits standard limited warranty and terms and conditions (collectively, "Standard Terms"); Purchasers of this part are entitled to the rights and benefits contained therein. For a full statement of the Standard Terms and the exclusive rights and remedies thereunder, please visit Mini-Circuits' website at www.minicircuits.com/MCLStore/terms.jsp



+12 to +32 dBm

Limiter

CLM-83-2W+

50Ω Broadband 30 to 8200 MHz

Product Features

- wideband, 30 to 8200 MHz
- low insertion loss 0.5 dB typ.
- fast recovery time, 10nsec typ.
- excellent VSWR 1.2:1 typ.
- low output power, 11.5 dBm typ.
- ceramic, hermetic, Nitrogen filled



CASE STYLE: DL1721

+RoHS Compliant

The +Suffix identifies RoHS Compliance. See our web site for RoHS Compliance methodologies and qualifications

Typical Applications

- military, hi-rel applications
- stabilizing generator outputs
- reducing amplitude variations
- protects low noise amplifiers and other devices from ESD or input power damage

MIL Screening Available
Please consult Applications Dept.

General Description

The CLM-83-2W+ is an RoHS-compliant limiter utilizing PIN diodes on an LTCC substrate, all hermetically sealed under a controlled nitrogen atmosphere. Terminal finish on the tiny, low-profile case is Ni-Pd-Au, delivering excellent electrical performance across a very wide bandwidth, with low insertion loss, excellent return loss, and low output power.

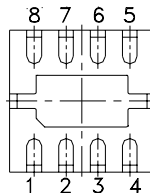

Pad Description

Function	Pad Number	Description
RF IN	2	RF input pad
RF-OUT	7	RF output pad
GND	1,3,4,5,6,8, Bottom Center Paddle	Connected to ground.

Notes

- A. Performance and quality attributes and conditions not expressly stated in this specification document are intended to be excluded and do not form a part of this specification document.
 B. Electrical specifications and performance data contained in this specification document are based on Mini-Circuit's applicable established test performance criteria and measurement instructions.
 C. The parts covered by this specification document are subject to Mini-Circuits standard limited warranty and terms and conditions (collectively, "Standard Terms"); Purchasers of this part are entitled to the rights and benefits contained therein. For a full statement of the Standard Terms and the exclusive rights and remedies thereunder, please visit Mini-Circuits' website at www.minicircuits.com/MCLStore/terms.jsp



Electrical Specifications at 25°C

Parameter	Condition	Min.	Typ.	Max.	Units
Frequency Range		30		8200	MHz
Linear Range					
Max Input Power	less than 0.1 dB compression	—	—	2	dBm
Insertion Loss	less than +2 dBm input power	—	0.5	1.3	dB
VSWR	less than +2 dBm input power	—	1.2	1.6	:1
Limiting Range					
Input Power	>1dB compression filtered signal frequency	+12	—	+32	dBm
Output Power		—	+11.5	—	dBm
Δ Output/ Δ 1dB Input	Input Power Range (dBm)				
	12 to 20	—	0.4	—	dB/dB
	20 to 25	—	0.2	—	
25 to 32	—	0.8	—		
Recovery Time	1 watt pulse, 50 μsec PW, 1kHz duty cycle, recovery to within 90% of final value	—	10	—	nsec
Response Time	30 dBm input, 50 μsec PW, 1 kHz duty cycle	—	2	—	nsec

Absolute Maximum Ratings

Operating Temperature	-40°C to 85°C
Storage Temperature	-55°C to 100°C
RF Input Power	2W

Permanent damage may occur if any of these limits are exceeded.

Notes

- A. Performance and quality attributes and conditions not expressly stated in this specification document are intended to be excluded and do not form a part of this specification document.
- B. Electrical specifications and performance data contained in this specification document are based on Mini-Circuit's applicable established test performance criteria and measurement instructions.
- C. The parts covered by this specification document are subject to Mini-Circuits standard limited warranty and terms and conditions (collectively, "Standard Terms"); Purchasers of this part are entitled to the rights and benefits contained therein. For a full statement of the Standard Terms and the exclusive rights and remedies thereunder, please visit Mini-Circuits' website at www.minicircuits.com/MCLStore/terms.jsp



Characterization Test Circuit

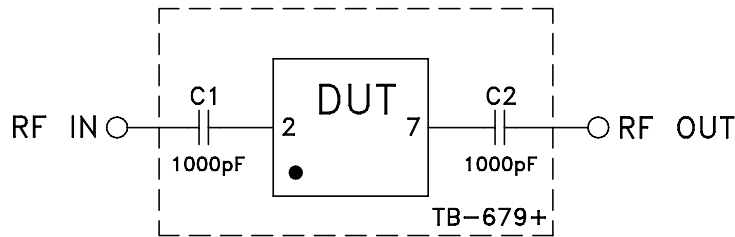
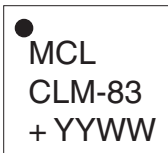

Fig. 1. Block Diagram of Test Circuit used for characterization. Mini-Circuits test board TB-679+. Insertion loss, return loss, and VSWR measured using Agilent N5230A network analyzer. Performance at frequencies below 30 MHz may be improved by increasing capacitance at C1 and C2. Depending on application requirements, this device may be effective at frequencies up to 10 GHz.
 Conditions:
 1. Frequency range tested: 1 to 10000 MHz
 2. RF input power tested: -12 to +33 dBm

Product Marking



Additional Detailed Technical Information	
<i>additional information is available on our dash board. To access this information click here</i>	
Performance Data	Data Table
	Swept Graphs
Case Style	DL1721 <i>Ceramic package, exposed paddle, Terminal finish: Ni,Pd,Au</i>
Tape & Reel	F66-1
Standard quantities available on reel	<i>7" reels with 10, 20, 50, 100, 200, 500 or 1K, 2K devices.</i>
Suggested Layout for PCB Design	PL-377
Evaluation Board	TB-679+
Environmental Ratings	ENV-67

ESD Rating

Human Body Model (HBM): Class 3B (>8000V) in accordance with JESD22-A114

Machine Model (MM): Class C (>400) in accordance with JESD22-A115

MSL Rating

Moisture Sensitivity: MSL1 in accordance with IPC/JEDEC J-STD-020D

Notes

- A. Performance and quality attributes and conditions not expressly stated in this specification document are intended to be excluded and do not form a part of this specification document.
- B. Electrical specifications and performance data contained in this specification document are based on Mini-Circuit's applicable established test performance criteria and measurement instructions.
- C. The parts covered by this specification document are subject to Mini-Circuits standard limited warranty and terms and conditions (collectively, "Standard Terms"); Purchasers of this part are entitled to the rights and benefits contained therein. For a full statement of the Standard Terms and the exclusive rights and remedies thereunder, please visit Mini-Circuits' website at www.minicircuits.com/MCLStore/terms.jsp



Typical Performance Data

Test Conditions @ +25°C										
FREQUENCY	LOW INPUT POWER		POWER OUTPUT (dBm)				DELTA OUTPUT/1dB DELTA INPUT (dB/dB)			
	INSERTION LOSS	VSWR		+12 dBm	+20 dBm	+25 dBm	+32 dBm	+12 to +20 dBm	+20 to +25 dBm	+25 to +32 dBm
(MHz)	(dB)	Input	Output	INPUT	INPUT	INPUT	INPUT	INPUT	INPUT	INPUT
		(:1)								
30.0	0.07	1.22	1.22	9.58	10.45	11.07	11.58	0.11	0.12	0.07
90.0	0.03	1.06	1.06	9.28	10.39	10.69	11.32	0.14	0.06	0.09
100.0	0.03	1.06	1.06	9.26	10.46	10.68	11.38	0.15	0.04	0.10
250.0	0.05	1.02	1.02	8.96	9.95	10.66	11.85	0.12	0.14	0.17
400.0	0.06	1.02	1.03	8.82	10.15	10.63	12.19	0.17	0.10	0.22
550.0	0.08	1.02	1.03	8.63	10.00	10.71	12.28	0.17	0.14	0.22
700.0	0.11	1.03	1.04	8.27	10.20	10.73	12.10	0.24	0.11	0.20
850.0	0.14	1.03	1.05	8.21	10.19	11.37	11.31	0.25	0.24	-0.01
1000.0	0.12	1.03	1.06	8.56	10.65	11.93	9.71	0.26	0.26	-0.32
1100.0	0.13	1.03	1.06	8.33	11.05	11.59	11.08	0.34	0.11	-0.07
1200.0	0.14	1.04	1.07	8.78	10.16	11.66	9.52	0.17	0.30	-0.31
1800.0	0.18	1.10	1.13	9.00	10.89	10.40	7.62	0.24	-0.10	-0.40
1900.0	0.19	1.11	1.14	8.77	11.29	10.22	7.86	0.32	-0.21	-0.34
2000.0	0.20	1.12	1.15	8.70	11.27	10.17	8.05	0.32	-0.22	-0.30
2200.0	0.21	1.15	1.17	8.70	11.30	9.67	7.60	0.33	-0.33	-0.30
2400.0	0.22	1.16	1.19	8.98	10.59	8.40	8.09	0.20	-0.44	-0.04
2600.0	0.23	1.18	1.20	9.13	10.72	7.95	8.38	0.20	-0.55	0.06
2800.0	0.24	1.19	1.21	9.09	10.23	8.02	7.74	0.14	-0.44	-0.04
3000.0	0.25	1.20	1.22	9.11	9.61	7.56	7.89	0.06	-0.41	0.05
3200.0	0.25	1.19	1.21	9.31	9.73	6.89	8.49	0.05	-0.57	0.23
3400.0	0.25	1.19	1.21	9.64	8.78	6.20	9.34	-0.11	-0.52	0.45
3600.0	0.25	1.18	1.20	9.68	7.90	6.47	9.16	-0.22	-0.29	0.38
3800.0	0.25	1.17	1.19	9.78	8.87	6.18	8.82	-0.11	-0.54	0.38
4000.0	0.24	1.14	1.16	9.83	8.44	6.57	9.00	-0.17	-0.37	0.35
4200.0	0.23	1.13	1.14	10.01	8.03	6.65	9.96	-0.25	-0.28	0.47
4400.0	0.24	1.12	1.13	10.11	7.77	6.64	10.01	-0.29	-0.23	0.48
4600.0	0.23	1.10	1.10	9.97	7.40	6.63	9.50	-0.32	-0.15	0.41
4800.0	0.24	1.11	1.10	9.89	6.07	6.40	9.13	-0.48	0.07	0.39
5000.0	0.25	1.10	1.09	10.03	6.86	6.76	10.04	-0.40	-0.02	0.47
5200.0	0.27	1.11	1.08	9.87	6.01	6.84	10.22	-0.48	0.17	0.48
5400.0	0.28	1.12	1.08	9.86	5.28	6.68	9.55	-0.57	0.28	0.41
5600.0	0.30	1.13	1.08	9.95	5.87	6.18	7.95	-0.51	0.06	0.25
5800.0	0.34	1.14	1.08	9.77	5.54	5.78	7.81	-0.53	0.05	0.29
6000.0	0.35	1.14	1.09	9.82	5.11	6.05	7.90	-0.59	0.19	0.26
6200.0	0.37	1.14	1.09	9.92	5.30	6.00	8.11	-0.58	0.14	0.30
6400.0	0.39	1.14	1.09	9.95	5.16	6.21	8.44	-0.60	0.21	0.32
6600.0	0.41	1.15	1.09	9.86	5.09	6.07	8.08	-0.60	0.20	0.29
6800.0	0.42	1.16	1.12	9.86	5.11	6.29	8.24	-0.59	0.24	0.28
7000.0	0.45	1.17	1.13	10.05	5.60	6.46	8.92	-0.56	0.17	0.35
7200.0	0.48	1.18	1.15	9.94	5.22	6.82	9.57	-0.59	0.32	0.39
7400.0	0.50	1.19	1.17	9.55	5.04	6.46	8.56	-0.56	0.28	0.30
7600.0	0.53	1.21	1.20	9.56	5.74	5.95	7.96	-0.48	0.04	0.29
7800.0	0.55	1.21	1.22	9.29	5.44	6.07	8.09	-0.48	0.13	0.29
8000.0	0.59	1.24	1.25	9.42	5.42	6.46	9.46	-0.50	0.21	0.43
8200.0	0.61	1.22	1.25	8.41	4.47	4.96	7.29	-0.49	0.10	0.33



P.O. Box 350166, Brooklyn, New York 11235-0003 (718) 934-4500 • Fax (718) 332-4661 For detailed performance specs & shopping online see Mini-Circuits web site
 The Design Engineers Search Engine Provides ACTUAL Data Instantly From MINI-CIRCUITS At: www.minicircuits.com



IF/RF MICROWAVE COMPONENTS

REV. A
 CLM-83-2W+
 11/28/2012
 Page 1 of 4

Surface Mount Limiter

CLM-83-2W+

Typical Performance Data

Test Conditions @ -55°C										
FREQUENCY	LOW INPUT POWER			POWER OUTPUT (dBm)				DELTA OUTPUT/1dB DELTA INPUT (dB/dB)		
	INSERTION LOSS	VSWR		+12 dBm	+20 dBm	+25 dBm	+32 dBm	+12 to +20 dBm	+20 to +25 dBm	+25 to +32 dBm
(MHz)		(dB)	Input							
		(:1)								
30.0	0.06	1.23	1.23	10.48	11.38	11.95	12.31	0.11	0.11	0.05
90.0	0.02	1.07	1.07	10.45	11.53	11.65	12.05	0.14	0.02	0.06
100.0	0.02	1.07	1.07	10.42	11.60	11.63	12.07	0.15	0.01	0.06
250.0	0.03	1.02	1.02	10.24	11.05	11.51	12.24	0.10	0.09	0.10
400.0	0.04	1.01	1.03	10.22	11.25	11.45	12.58	0.13	0.04	0.16
550.0	0.05	1.03	1.02	10.09	10.98	11.41	12.80	0.11	0.09	0.20
700.0	0.07	1.03	1.04	9.68	11.11	11.27	12.80	0.18	0.03	0.22
850.0	0.12	1.03	1.05	9.53	10.86	11.89	12.02	0.17	0.21	0.02
1000.0	0.07	1.03	1.04	9.73	11.21	12.52	9.96	0.19	0.26	-0.37
1100.0	0.07	1.01	1.05	9.70	11.55	12.14	11.69	0.23	0.12	-0.06
1200.0	0.08	1.01	1.05	10.13	10.66	12.34	9.44	0.07	0.34	-0.41
1800.0	0.11	1.07	1.10	10.02	11.47	10.74	7.89	0.18	-0.15	-0.41
1900.0	0.12	1.08	1.11	9.73	11.85	10.48	7.79	0.27	-0.27	-0.38
2000.0	0.13	1.11	1.13	9.62	11.77	10.55	7.35	0.27	-0.24	-0.46
2200.0	0.14	1.14	1.17	9.47	11.73	9.64	7.14	0.28	-0.42	-0.36
2400.0	0.15	1.18	1.20	9.55	10.68	6.19	10.45	0.14	-0.90	0.61
2600.0	0.16	1.21	1.24	9.61	11.04	4.60	9.37	0.18	-1.29	0.68
2800.0	0.16	1.22	1.24	9.45	10.68	7.04	8.36	0.15	-0.73	0.19
3000.0	0.17	1.23	1.25	9.47	9.91	6.54	9.42	0.05	-0.67	0.41
3200.0	0.16	1.24	1.27	9.65	9.95	5.84	8.74	0.04	-0.82	0.41
3400.0	0.15	1.20	1.22	9.93	8.15	5.55	8.60	-0.22	-0.52	0.44
3600.0	0.13	1.18	1.21	10.06	7.42	5.55	8.83	-0.33	-0.37	0.47
3800.0	0.12	1.14	1.16	10.28	8.72	5.72	7.57	-0.20	-0.60	0.26
4000.0	0.10	1.09	1.12	10.43	7.91	5.53	8.86	-0.32	-0.48	0.48
4200.0	0.10	1.07	1.10	10.52	7.08	6.14	7.74	-0.43	-0.19	0.23
4400.0	0.10	1.06	1.08	10.64	5.54	6.27	7.73	-0.64	0.15	0.21
4600.0	0.11	1.09	1.09	10.44	5.16	6.15	7.34	-0.66	0.20	0.17
4800.0	0.12	1.10	1.10	10.47	3.61	6.62	7.01	-0.86	0.60	0.06
5000.0	0.14	1.11	1.09	10.52	4.51	6.84	7.27	-0.75	0.47	0.06
5200.0	0.16	1.15	1.13	10.37	3.93	6.68	7.62	-0.81	0.55	0.13
5400.0	0.17	1.13	1.10	10.29	3.32	6.40	7.24	-0.87	0.62	0.12
5600.0	0.18	1.13	1.12	10.37	3.82	6.36	5.23	-0.82	0.51	-0.16
5800.0	0.20	1.12	1.09	10.13	3.69	5.91	4.94	-0.81	0.44	-0.14
6000.0	0.21	1.13	1.10	10.26	3.15	6.15	5.51	-0.89	0.60	-0.09
6200.0	0.22	1.13	1.10	10.34	3.68	5.87	6.10	-0.83	0.44	0.03
6400.0	0.22	1.12	1.09	10.54	3.71	5.95	5.66	-0.85	0.45	-0.04
6600.0	0.25	1.14	1.11	10.50	3.72	5.62	4.48	-0.85	0.38	-0.16
6800.0	0.25	1.13	1.11	10.63	3.39	5.77	4.95	-0.91	0.48	-0.12
7000.0	0.28	1.14	1.14	10.79	3.91	5.63	5.38	-0.86	0.34	-0.04
7200.0	0.28	1.15	1.15	10.72	3.57	5.89	6.06	-0.89	0.46	0.02
7400.0	0.29	1.17	1.19	10.47	3.60	5.83	5.57	-0.86	0.45	-0.04
7600.0	0.30	1.19	1.19	10.40	4.62	5.42	3.69	-0.72	0.16	-0.25
7800.0	0.32	1.22	1.23	10.23	3.40	5.71	5.27	-0.85	0.46	-0.06
8000.0	0.34	1.23	1.25	10.26	3.53	5.32	6.04	-0.84	0.36	0.10
8200.0	0.37	1.27	1.29	9.36	2.66	5.25	3.72	-0.84	0.52	-0.22



P.O. Box 350166, Brooklyn, New York 11235-0003 (718) 934-4500 • Fax (718) 332-4661 For detailed performance specs & shopping online see Mini-Circuits web site
 The Design Engineers Search Engine Provides ACTUAL Data Instantly From MINI-CIRCUITS At: www.minicircuits.com

IF/RF MICROWAVE COMPONENTS

REV. A
 CLM-83-2W+
 11/28/2012
 Page 2 of 4

Typical Performance Data

Test Conditions @ +100°C										
FREQUENCY	LOW INPUT POWER			POWER OUTPUT (dBm)				DELTA OUTPUT/1dB DELTA INPUT (dB/dB)		
	INSERTION LOSS	VSWR		+12 dBm INPUT	+20 dBm INPUT	+25 dBm INPUT	+32 dBm INPUT	+12 to +20 dBm INPUT	+20 to +25 dBm INPUT	+25 to +32 dBm INPUT
(MHz)		(dB)	Input							
		(:1)								
30.0	0.07	1.22	1.22	8.530	9.44	10.16	10.85	0.11	0.14	0.10
90.0	0.04	1.06	1.06	7.960	9.21	9.76	10.72	0.16	0.11	0.14
100.0	0.04	1.05	1.05	7.930	9.28	9.77	10.83	0.17	0.10	0.15
250.0	0.06	1.02	1.03	7.610	8.91	10.00	11.65	0.16	0.22	0.24
400.0	0.08	1.04	1.03	7.400	9.23	10.07	11.74	0.23	0.17	0.24
550.0	0.11	1.04	1.04	7.260	9.32	10.30	11.78	0.26	0.20	0.21
700.0	0.15	1.05	1.06	7.020	9.70	10.49	11.59	0.34	0.16	0.16
850.0	0.17	1.06	1.08	7.180	9.93	11.02	10.94	0.34	0.22	-0.01
1000.0	0.17	1.07	1.08	7.780	10.43	11.61	10.05	0.33	0.24	-0.22
1100.0	0.18	1.08	1.09	7.380	10.88	11.42	11.07	0.44	0.11	-0.05
1200.0	0.20	1.09	1.10	8.030	10.09	11.55	10.37	0.26	0.29	-0.17
1800.0	0.27	1.15	1.17	8.570	11.16	11.65	8.89	0.32	0.10	-0.39
1900.0	0.28	1.16	1.18	8.320	11.47	11.59	8.75	0.39	0.02	-0.41
2000.0	0.30	1.17	1.19	8.170	11.66	11.53	9.26	0.44	-0.03	-0.32
2200.0	0.32	1.19	1.21	8.110	11.54	11.45	9.76	0.43	-0.02	-0.24
2400.0	0.34	1.21	1.22	8.370	11.15	10.78	9.76	0.35	-0.07	-0.15
2600.0	0.36	1.21	1.22	8.450	11.77	10.39	9.94	0.42	-0.28	-0.06
2800.0	0.38	1.22	1.23	8.320	11.28	10.70	9.76	0.37	-0.12	-0.13
3000.0	0.40	1.22	1.23	8.240	11.04	10.40	9.49	0.35	-0.13	-0.13
3200.0	0.42	1.23	1.23	8.370	11.41	10.10	9.87	0.38	-0.26	-0.03
3400.0	0.45	1.22	1.23	8.650	10.90	9.31	11.13	0.28	-0.32	0.26
3600.0	0.45	1.22	1.22	8.610	10.69	9.75	10.88	0.26	-0.19	0.16
3800.0	0.46	1.22	1.22	8.660	10.96	9.34	10.54	0.29	-0.32	0.17
4000.0	0.48	1.21	1.21	8.650	10.64	9.90	10.69	0.25	-0.15	0.11
4200.0	0.48	1.20	1.20	8.870	10.38	9.19	12.02	0.19	-0.24	0.40
4400.0	0.50	1.20	1.19	8.880	10.54	9.08	12.20	0.21	-0.29	0.45
4600.0	0.50	1.19	1.16	8.660	10.31	9.03	11.73	0.21	-0.26	0.39
4800.0	0.52	1.20	1.16	8.510	9.97	8.71	11.38	0.18	-0.25	0.38
5000.0	0.52	1.19	1.14	8.580	9.99	8.60	12.05	0.18	-0.28	0.49
5200.0	0.55	1.18	1.10	8.350	9.58	8.41	12.23	0.15	-0.23	0.55
5400.0	0.57	1.18	1.09	8.240	9.25	8.09	11.67	0.13	-0.23	0.51
5600.0	0.59	1.19	1.08	8.340	9.06	8.06	10.08	0.09	-0.20	0.29
5800.0	0.64	1.19	1.08	8.070	8.88	7.75	9.65	0.10	-0.23	0.27
6000.0	0.66	1.19	1.07	8.090	8.31	7.86	10.03	0.03	-0.09	0.31
6200.0	0.70	1.18	1.08	8.140	8.41	7.84	10.36	0.03	-0.11	0.36
6400.0	0.74	1.20	1.10	8.200	7.86	8.20	10.83	-0.04	0.07	0.38
6600.0	0.79	1.21	1.11	8.050	8.02	8.09	10.28	0.00	0.01	0.31
6800.0	0.84	1.20	1.12	8.000	7.69	8.29	10.39	-0.04	0.12	0.30
7000.0	0.88	1.23	1.14	8.100	7.84	8.41	11.12	-0.03	0.11	0.39
7200.0	0.92	1.21	1.16	7.960	7.53	8.69	11.83	-0.05	0.23	0.45
7400.0	0.98	1.25	1.20	7.500	7.31	8.34	11.01	-0.02	0.21	0.38
7600.0	1.02	1.22	1.18	7.400	7.52	7.97	10.25	0.01	0.09	0.33
7800.0	1.08	1.24	1.24	7.230	7.28	7.87	10.57	0.01	0.12	0.39
8000.0	1.14	1.23	1.24	7.340	7.18	8.24	11.90	-0.02	0.21	0.52
8200.0	1.20	1.24	1.26	6.790	6.70	7.22	9.78	-0.01	0.10	0.37



P.O. Box 350166, Brooklyn, New York 11235-0003 (718) 934-4500 • Fax (718) 332-4661 For detailed performance specs & shopping online see Mini-Circuits web site
 The Design Engineers Search Engine Provides ACTUAL Data Instantly From MINI-CIRCUITS At: www.minicircuits.com



IF/RF MICROWAVE COMPONENTS

Surface Mount Limiter

CLM-83-2W+

Typical Performance Data

Test Conditions @ 25°C

POWER INPUT	POWER OUTPUT	POWER INPUT	POWER OUTPUT	POWER INPUT	POWER OUTPUT
@ 30 MHz		@ 3000 MHz		@ 8200 MHz	
(dBm)		(dBm)		(dBm)	
-10	-10.07	-10	-10.25	-10	-10.61
12	9.58	12	9.11	12	8.41
20	10.45	20	9.61	20	4.47
25	11.07	25	7.56	25	4.96
32	11.58	32	7.89	32	7.29

Test Conditions @ -55°C

POWER INPUT	POWER OUTPUT	POWER INPUT	POWER OUTPUT	POWER INPUT	POWER OUTPUT
@ 30 MHz		@ 3000 MHz		@ 8200 MHz	
(dBm)		(dBm)		(dBm)	
-10	-10.06	-10	-10.17	-10	-10.37
12	10.48	12	9.47	12	9.36
20	11.38	20	9.91	20	2.66
25	11.95	25	6.54	25	5.25
32	12.31	32	9.42	32	3.72

Test Conditions @ 100°C

POWER INPUT	POWER OUTPUT	POWER INPUT	POWER OUTPUT	POWER INPUT	POWER OUTPUT
@ 30 MHz		@ 3000 MHz		@ 8200 MHz	
(dBm)		(dBm)		(dBm)	
-10	-10.07	-10	-10.40	-10	-11.20
12	8.53	12	8.24	12	6.79
20	9.44	20	11.04	20	6.70
25	10.16	25	10.4	25	7.22
32	10.85	32	9.49	32	9.78



Typical Performance Curves @ +25°C

Insertion Loss vs Frequency

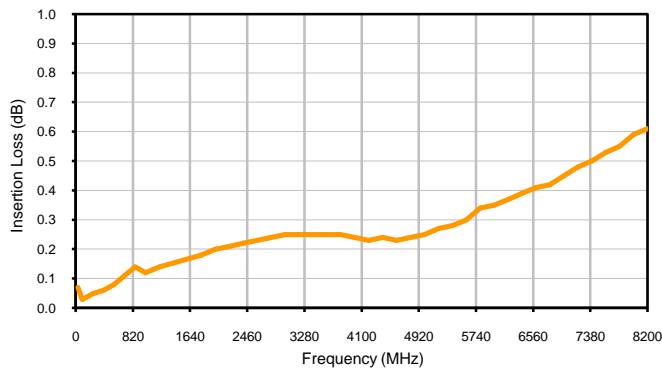

Power Output vs Power Input

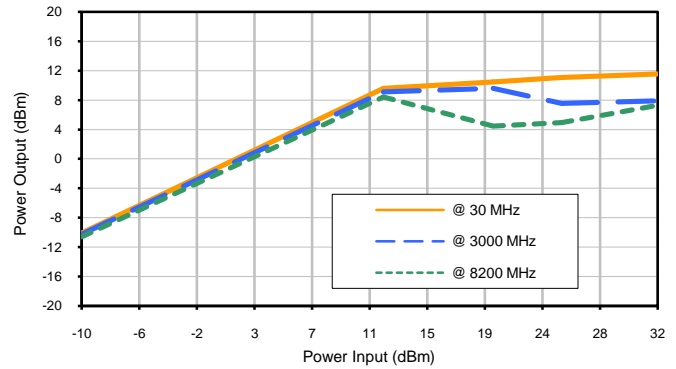

Power Output vs Frequency

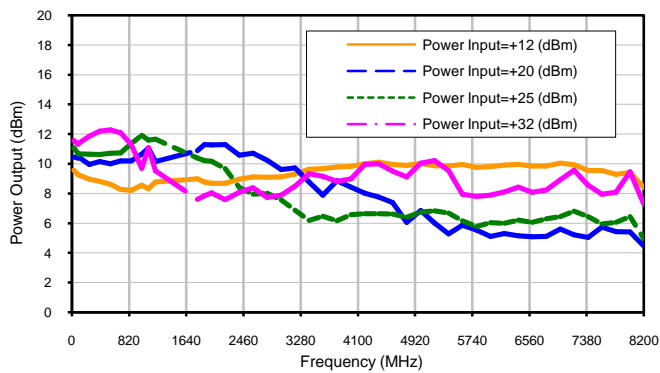

Delta Output / Delta 1dB Input

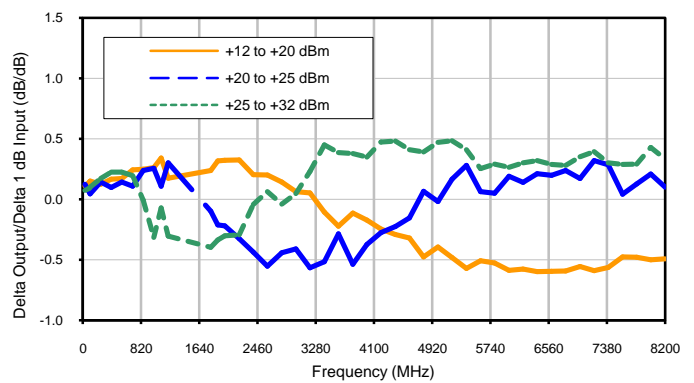

Input VSWR

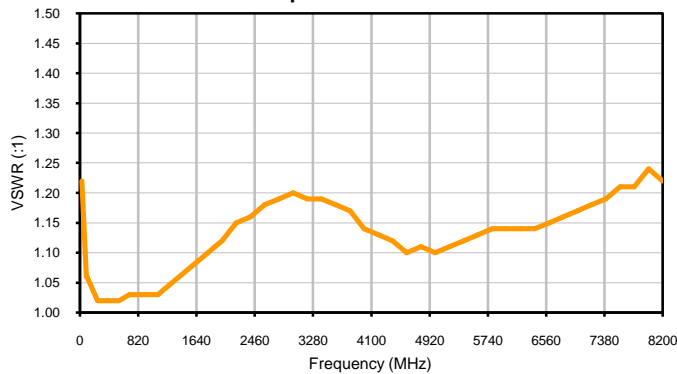

Output VSWR

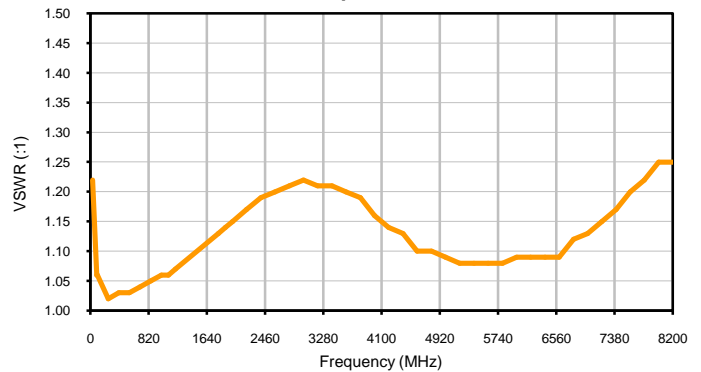

Typical Performance Curves @ -55°C

Insertion Loss vs Frequency

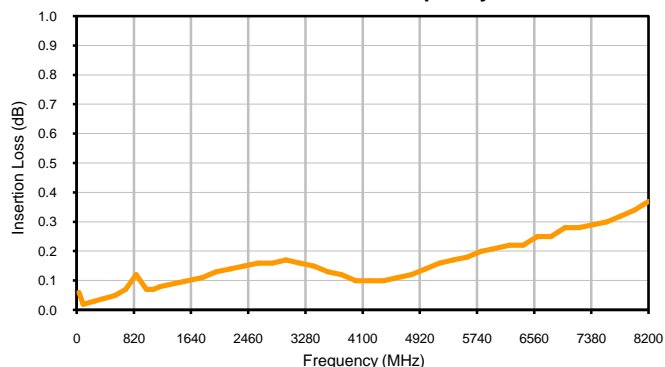

Power Output vs Power Input

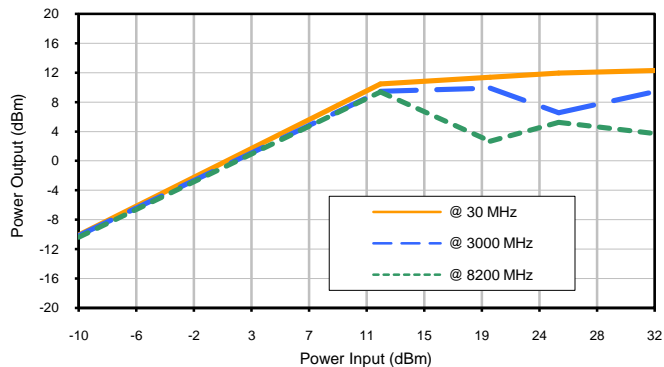

Power Output vs Frequency

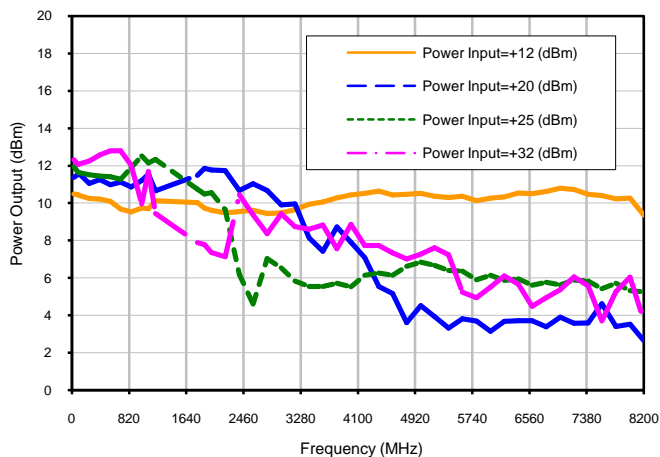

Delta Output / Delta 1dB Input

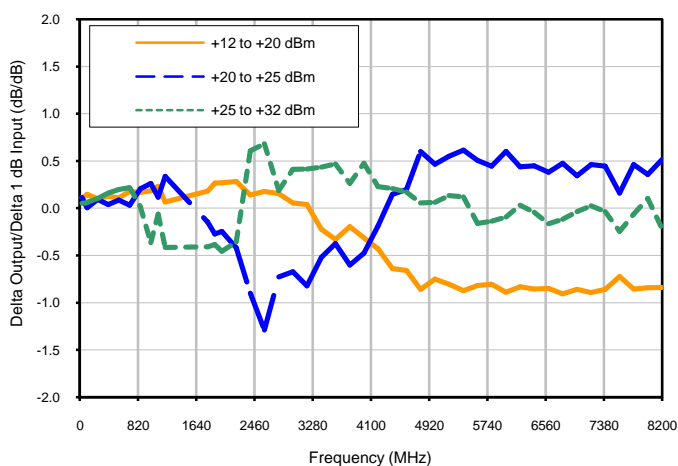

Input VSWR

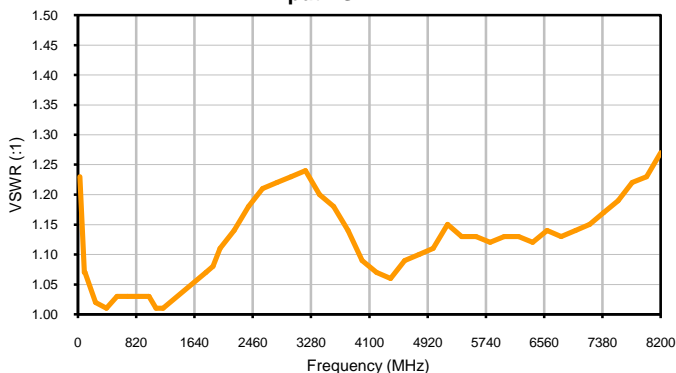

Output VSWR

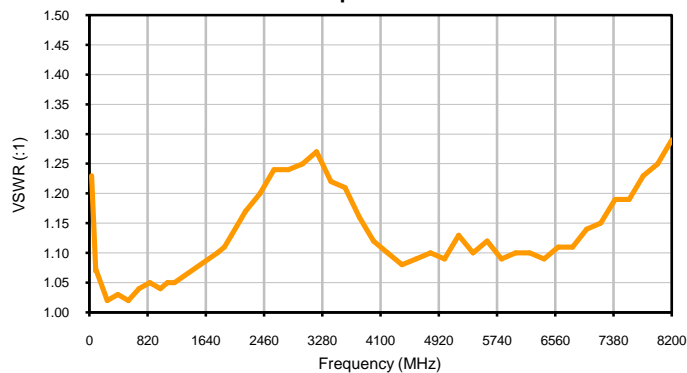

Surface Mount Limiter

CLM-83-2W+

Typical Performance Curves @ +100°C

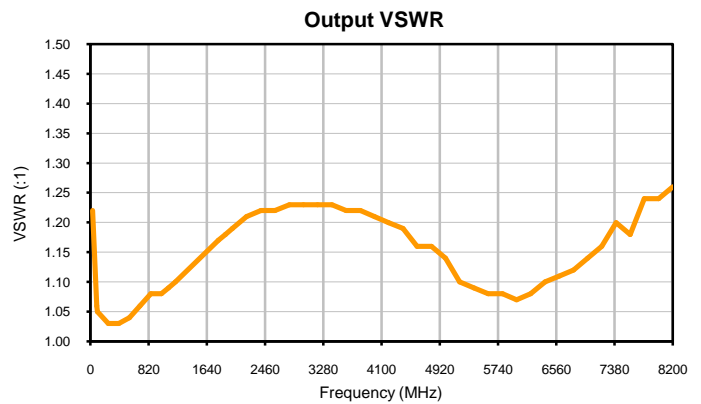
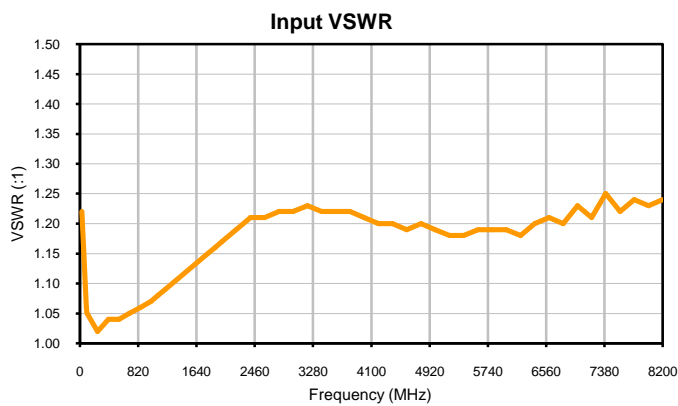
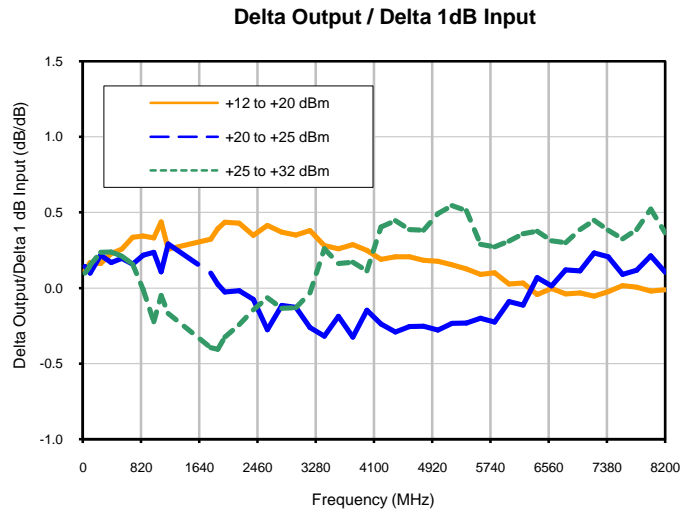
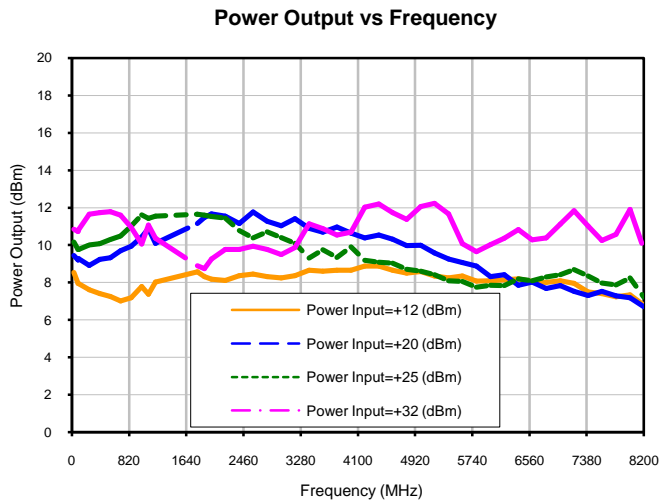
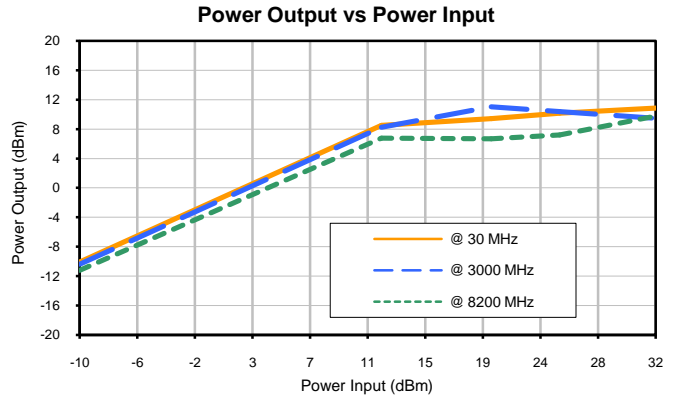
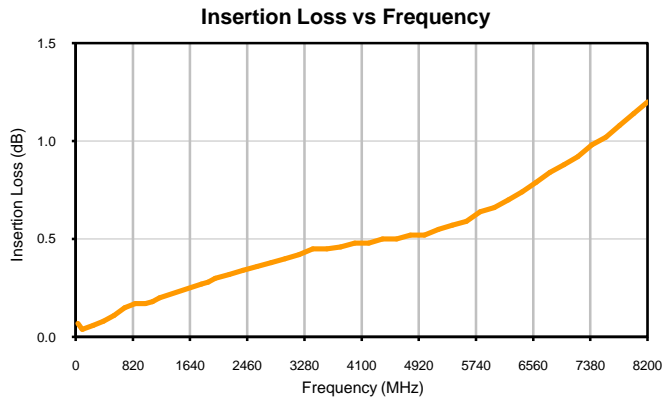

P.O. Box 350166, Brooklyn, New York 11235-0003 (718) 934-4500 • Fax (718) 332-4661 For detailed performance specs & shopping online see Mini-Circuits web site
The Design Engineers Search Engine Provides ACTUAL Data Instantly From MINI-CIRCUITS At: www.minicircuits.com



IF/RF MICROWAVE COMPONENTS

REV. A
CLM-83-2W+
11/28/2012
Page 3 of 3

Outline Dimensions

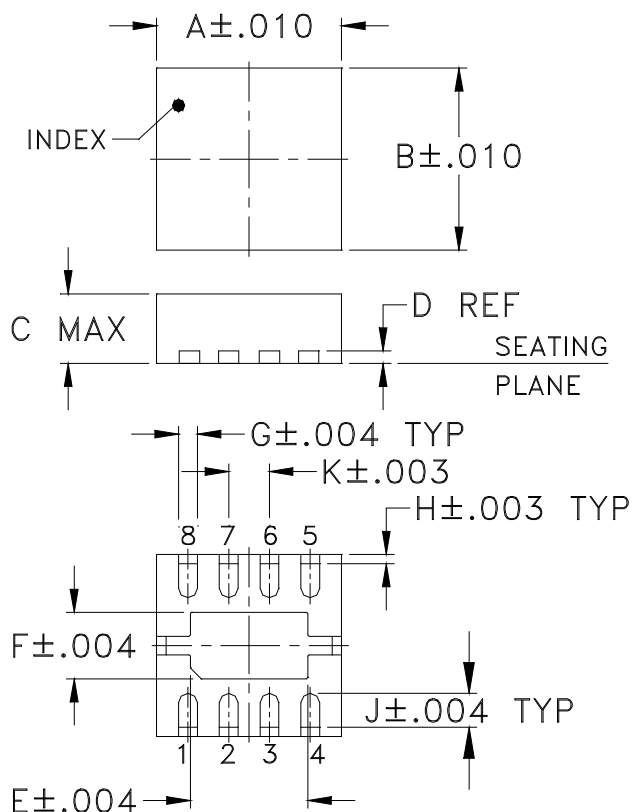

PCB Land Pattern

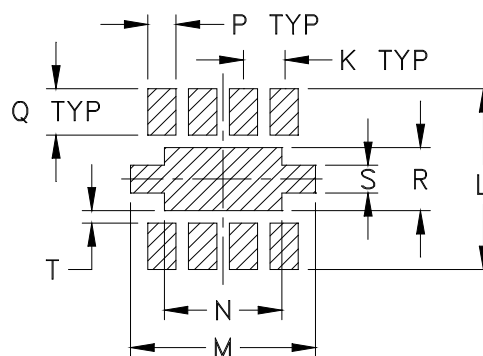

Suggested Layout,
Tolerance to be within $\pm.002$

CASE #	A	B	C	D	E	F	G	H	J	K	L	M	N
DL1721	.118 (3.00)	.118 (3.00)	.045 (1.14)	.008 (0.20)	.075 (1.91)	.043 (1.09)	.012 (0.30)	.006 (0.15)	.022 (0.56)	.026 (0.66)	.117 (2.97)	.118 (3.00)	.075 (1.91)

CASE #	P	Q	R	S	T	WT. GRAM
DL1721	.018 (0.46)	.030 (0.76)	.041 (1.04)	.018 (0.46)	.008 (0.20)	.02

Dimensions are in inches (mm). Tolerances: 3Pl. $\pm .004$, unless otherwise specified.

Notes:

1. Case material: LTCC.
2. Termination finish: Nickel-Palladium-Gold plating.



P.O. Box 350166, Brooklyn, New York 11235-0003 (718) 934-4500 Fax (718) 332-4661 For detailed performance specs & shopping online see Mini-Circuits web site



The Design Engineers Search Engine Provides ACTUAL Data Instantly From MINI-CIRCUITS At: www.minicircuits.com

RF/IF MICROWAVE COMPONENTS

Tape & Reel Packaging TR-F66-1

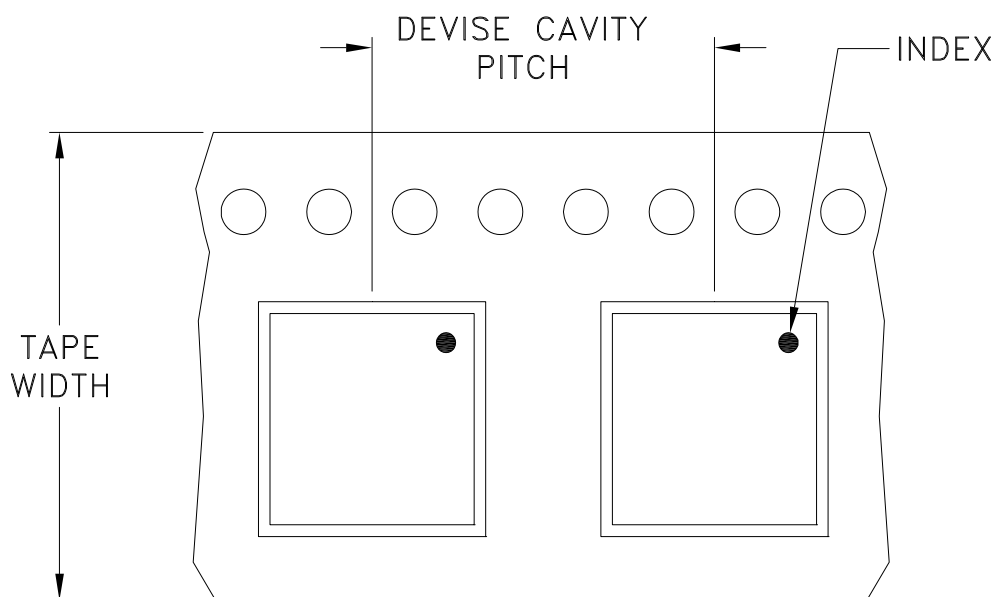

Tape Width, mm	Device Cavity Pitch, mm	Reel Size, inches	Devices per Reel see note	
8	4	7	Small quantity standard	20
				50
				100
				200
				500
		7	Standard	1000, 2000

Note: Please consult individual model data sheet to determine device per reel availability.

Mini-Circuits carrier tape materials provide protection from ESD (Electro-Static Discharge) during handling and transportation. Tapes are static dissipative and comply with industry standards EIA-481/EIA-541.

Go to: www.minicircuits.com/pages/pdfs/tape.pdf



INTERNET <http://www.minicircuits.com>

P.O. Box 350166, Brooklyn, New York 11235-0003 (718) 934-4500 Fax (718) 332-4661

Distribution Centers NORTH AMERICA 800-654-7949 • 417-335-5935 • Fax 417-335-5945 • EUROPE 44-1252-832600 • Fax 44-1252-837010

Mini-Circuits ISO 9001 & ISO 14001 Certified

THIRD ANGLE PROJECTION

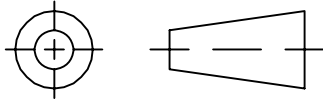

REVISIONS

REV	ECN No.	DESCRIPTION	DATE	DR	AUTH
OR	M140603	NEW RELEASE	02/27/13	AV	DJ

SUGGESTED MOUNTING CONFIGURATION FOR DL1721 CASE STYLE, "08LM01" PIN CONNECTION

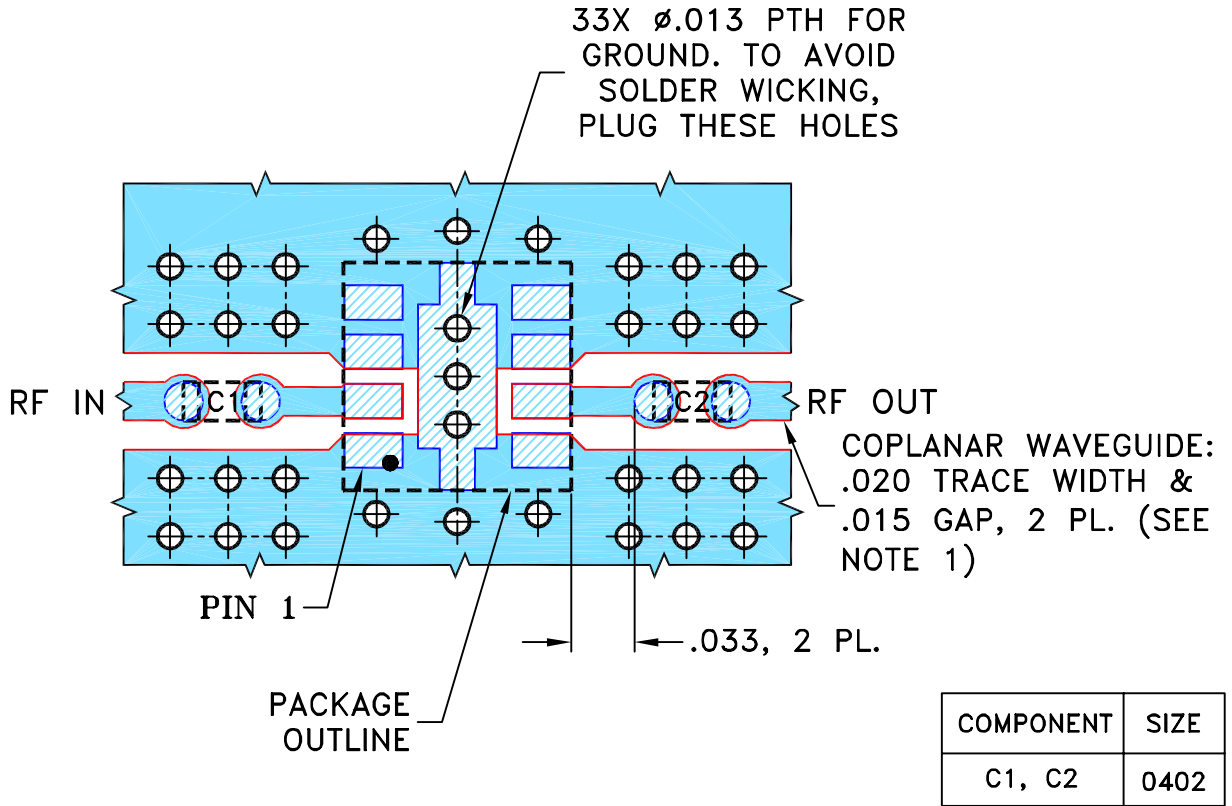

NOTES:

1. COPLANAR WAVEGUIDE PARAMETERS ARE SHOWN FOR ROGERS R04350B WITH DIELECTRIC THICKNESS $.010'' \pm .001''$; COPPER: 1/2 OZ. ON EACH SIDE. FOR OTHER MATERIALS TRACE WIDTH AND GAP MAY NEED TO BE MODIFIED.
2. CHIP COMPONENT FOOT PRINT SHOWN FOR REFERENCE. FOR COMPONENT VALUES REFER TO TB-679+.
3. BOTTOM SIDE OF THE PCB IS CONTINUOUS GROUND PLANE.

- DENOTES PCB COPPER LAYOUT WITH SMOBC (SOLDER MASK OVER BARE COPPER)
- DENOTES COPPER LAND PATTERN FREE OF SOLDER MASK

UNLESS OTHERWISE SPECIFIED	INITIALS	DATE
DRAWN	AV	02/20/13
CHECKED	IL	02/27/13
APPROVED	\DJ	02/27/13

Mini-Circuits® 13 Neptune Avenue
Brooklyn NY 11235

PL, 08LM01, DL1721, TB-679+

Mini-Circuits®
THIS DOCUMENT AND ITS CONTENTS ARE THE PROPERTY OF MINI-CIRCUITS. EXCEPT FOR USE EXPRESSLY GRANTED, IN WRITING, TO ITS VENDORS, VENDEE AND THE UNITED STATES GOVERNMENT, MINI-CIRCUITS RESERVES ALL PROPRIETARY DESIGN, USE, MANUFACTURING AND REPRODUCTION RIGHTS THERETO. THESE CONTENTS SHALL NOT BE USED, DUPLICATED OR DISCLOSED TO ANY OUTSIDE PARTY, IN WHOLE OR IN PART, WITHOUT WRITTEN PERMISSION OF MINI-CIRCUITS.

SIZE	CODE IDENT	DRAWING NO:	REV:
A	15542	98-PL-377	OR
FILE:	98PL377	SCALE: 10:1	SHEET: 1 OF 1

Evaluation Board and Circuit

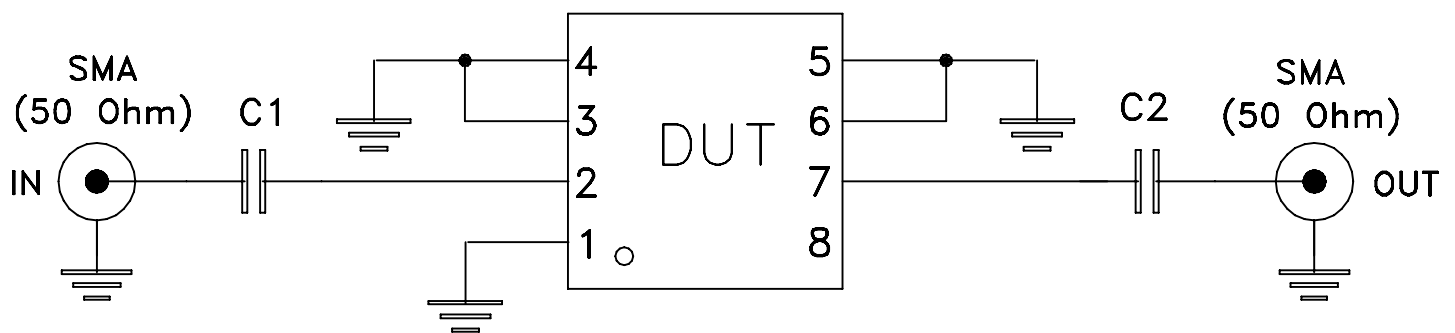
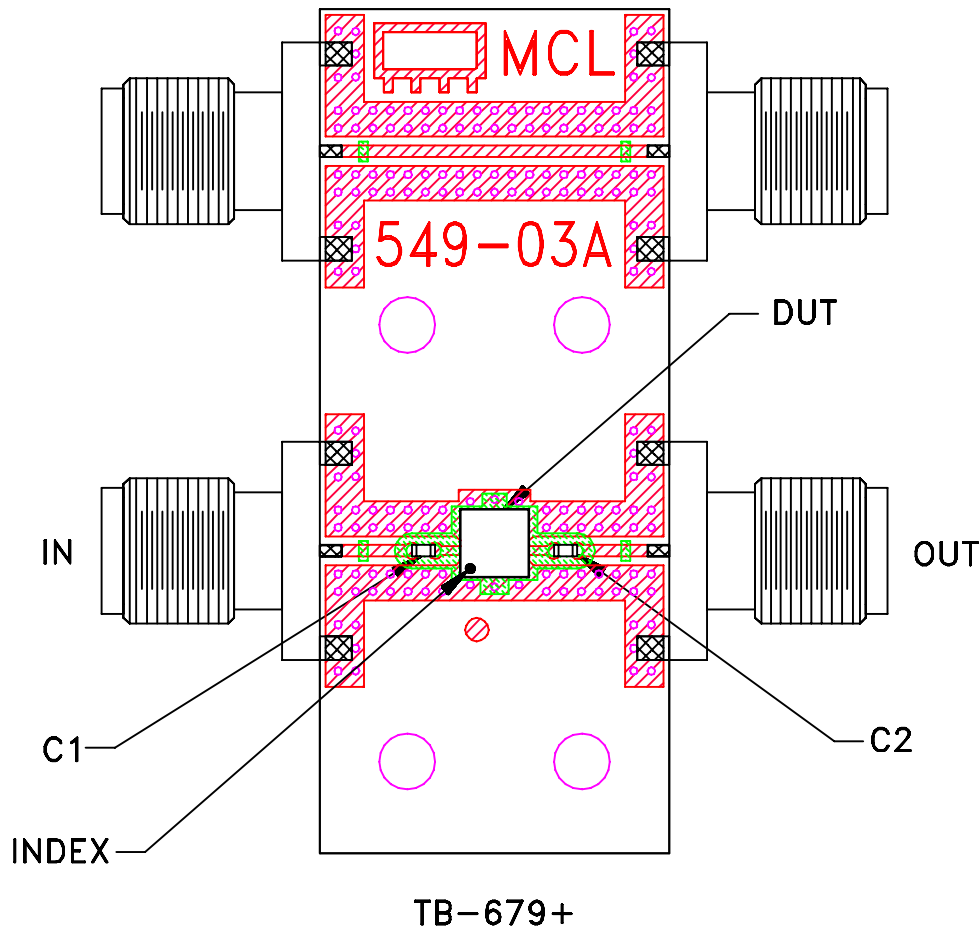

COMPONENT	VALUE/PART NUMBER
C1, C2	0.001 uF

Schematic Diagram

Notes:

1. 50 Ohm SMA Female connectors.
2. PCB Material: R04350 or equivalent,
Dielectric Constant=3.5, Thickness=.010 inch.

 **Mini-Circuits®**

All Mini-Circuits products are manufactured under exacting quality assurance and control standards, and are capable of meeting published specifications after being subjected to any or all of the following physical and environmental test.

Specification	Test/Inspection Condition	Reference/Spec
Operating Temperature	-55° to 100° C Ambient Environment	Individual Model Data Sheet
Storage Temperature	-65° to 125° C	Individual Model Data Sheet
Thermal Shock (device level)	-55° to 125°C, 100 cycles	MIL-STD-202, Method 107
Thermal Shock (board level)	-55° to 125°C, 1000 cycles	MIL-STD-202, Method 107
Constant Acceleration	Y1 plane only, 30 Kg	MIL-STD-883, Method 2001, Cond. E
Vibration	10-2000MHz sine, 20g, 3 axis	MIL-STD-202, Method 204, Cond. D
Mechanical Shock	Y1 plane, 5 pulses, .5ms, 1.5 Kg	MIL-STD-202, Method 213, Cond. A
PIND	20G's @130 Hz	MIL-STD-750, Method 2052.2
Resistance to Soldering Heat	3X Reflow, Peak Temperature 260°C, electrical End points	JESD22-B102
Resistance to Solvent	15 pieces, 5 pieces each solvent, marking permanency	MIL-STD-202, Method 215
Moisture Sensitivity Level	Hermetic device, MSL-1 by construction	JESD22-A113, MSL1/260
Hermeticity	Fine Leak, Gross Leak	MIL-STD-202, Method 112, Cond. C&D

All Mini-Circuits products are manufactured under exacting quality assurance and control standards, and are capable of meeting published specifications after being subjected to any or all of the following physical and environmental test.

Specification	Test/Inspection Condition	Reference/Spec
----------------------	----------------------------------	-----------------------

Autoclave	15 psig, 100% RH, 121°C, 96 hours	JEDEC-STD-22-B, Method A102
-----------	-----------------------------------	-----------------------------