



Connectors > Power Connectors > Circular Power > Circular Power Connectors



Connector Product Type: **Housing**

Operating Voltage: **600 VDC**

Connector System: **Wire-to-Wire**

Number of Positions: **9**

Sealable: **No**

Features

Product Type Features

Connector Product Type	Housing
Connector System	Wire-to-Wire
Sealable	No
Connector & Contact Terminates To	Wire & Cable
Connector & Housing Type	Plug
Circular Connector Shell Type	All Plastic

Configuration Features

Reverse Numbering	Without
Number of Positions	9
Number of Power Positions	0
Number of Signal Positions	9

Electrical Characteristics

Operating Voltage	600 VAC
-------------------	---------

Contact Features



Reverse Gender	No
Contact Type	Socket
Contact Current Rating (Max)	13 A
Contact Protection	With

Mechanical Attachment

Mating Alignment Type	Keyed
Mating Alignment	With
Panel Mount Feature Type	Flange
Mating Retention Type	Threaded Coupling
Thread Size	3/4 - 20 UNEF-2A
Polarization Code	A
Mating Retention	With
Panel Mount Feature	Without

Housing Features

Body Orientation	Straight
Housing Color	Black
Housing Material	PA 6.6 GF
Circular Connector Shell Size	13

Usage Conditions

Operating Temperature Range	-55 – 105 °C[-67 – 221 °F]
Fluid Resistance	None

Operation/Application

Circuit Application	Signal
Shielded	No

Industry Standards

UL Flammability Rating	UL 94V-0
------------------------	----------

Packaging Features

Packaging Quantity	5
Packaging Method	Small Pack

Product Compliance

[For compliance documentation, visit the product page on TE.com>](#)



EU RoHS Directive 2011/65/EU	Compliant
EU ELV Directive 2000/53/EC	Compliant
China RoHS 2 Directive MIIT Order No 32, 2016	No Restricted Materials Above Threshold
EU REACH Regulation (EC) No. 1907/2006	Current ECHA Candidate List: JUNE 2024 (241) Candidate List Declared Against: JUNE 2024 (241) Does not contain REACH SVHC
Halogen Content	BFR/CFR/PVC Free, but Br/Cl >900 ppm in other sources.
Solder Process Capability	Not applicable for solder process capability

Product Compliance Disclaimer

This information is provided based on reasonable inquiry of our suppliers and represents our current actual knowledge based on the information they provided. This information is subject to change. The part numbers that TE has identified as EU RoHS compliant have a maximum concentration of 0.1% by weight in homogenous materials for lead, hexavalent chromium, mercury, PBB, PBDE, DBP, BBP, DEHP, DIBP, and 0.01% for cadmium, or qualify for an exemption to these limits as defined in the Annexes of Directive 2011/65/EU (RoHS2). Finished electrical and electronic equipment products will be CE marked as required by Directive 2011/65/EU. Components may not be CE marked. Additionally, the part numbers that TE has identified as EU ELV compliant have a maximum concentration of 0.1% by weight in homogenous materials for lead, hexavalent chromium, and mercury, and 0.01% for cadmium, or qualify for an exemption to these limits as defined in the Annexes of Directive 2000/53/EC (ELV). Regarding the REACH Regulation, the information TE provides on SVHC in articles for this part number is based on the latest European Chemicals Agency (ECHA) 'Guidance on requirements for substances in articles' posted at this URL: <https://echa.europa.eu/guidance-documents/guidance-on-reach>

Compatible Parts



Also in the Series | AMP CPC

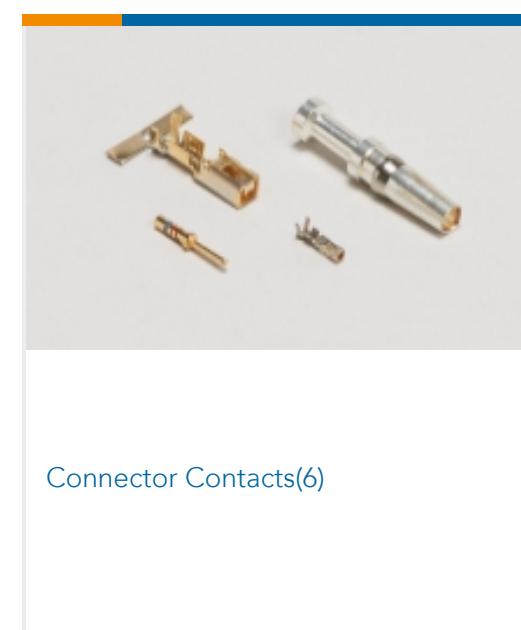
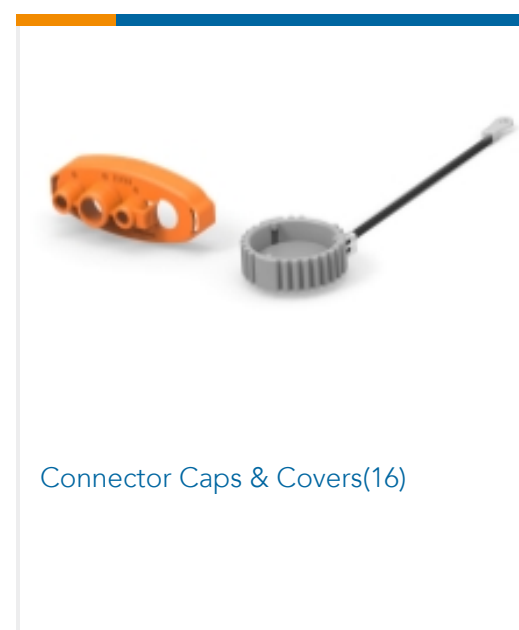
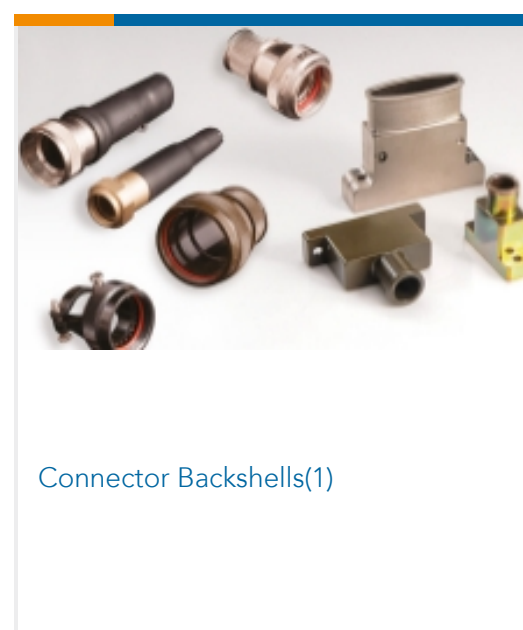
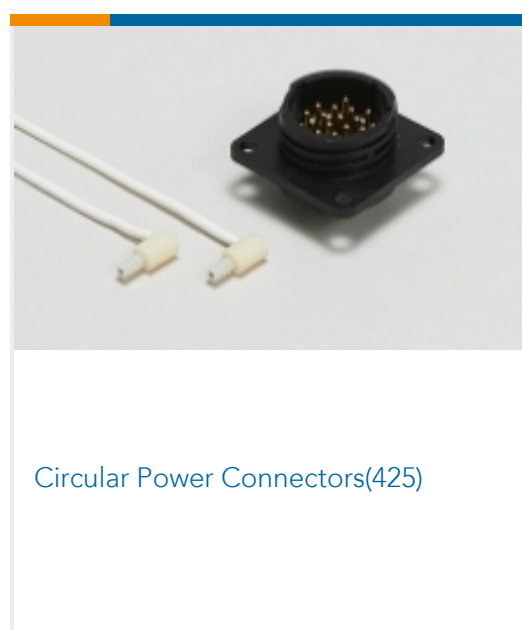



Connector Hardware(12)



Connector Seals & Cavity Plugs(35)



Connector Strain Relief(60)



Insertion & Extraction Tools(1)

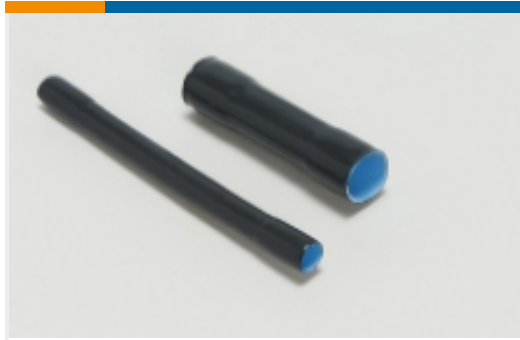

Sealing Sleeves(2)

Customers Also Bought



TE Part #206705-2
CPC 13-9 FREE HANGING RECPT



TE Part #206705-1
CPC RECP. ASY SIZE 13-9



TE Part #206966-7
CABLE SHELL CLAMP SIZE 13

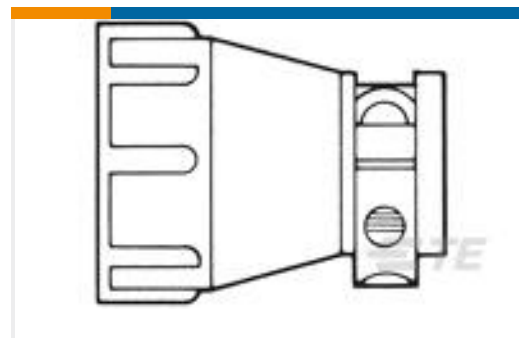

TE Part #206966-9
CABLE CLAMP KIT, BULK PKG



TE Part #66101-2
III+ SKT, 18-16, TIN-LEAD, LP



TE Part #5650470-5
ASSY, PIN, EUROCARD, TYPE R, LEAD-



TE Part #66098-8
III+ PIN, 18-16, 15AU/FL, STRIP

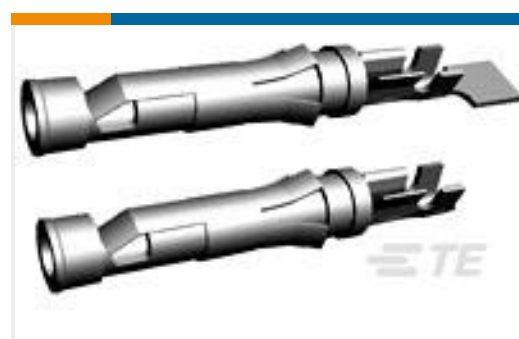

TE Part #66108-8
III+ SKT, 26-24, 30AU/FL, STRIP



TE Part #1-208223-1
CPC RCPT ASSEMBLY SIZE 13-9



TE Part #621836-000
SO63-3-55-22-90

Documents



Product Drawings

CPC PLUG,SZ 13-9,SMALL PACK

English

CAD Files

3D PDF

3D

Customer View Model

[ENG_CVM_CVM_206708-2_S.2d_dxf.zip](#)

English

Customer View Model

[ENG_CVM_CVM_206708-2_S.3d_igs.zip](#)

English

Customer View Model

[ENG_CVM_CVM_206708-2_S.3d_stp.zip](#)

English

By downloading the CAD file I accept and agree to the [Terms and Conditions](#) of use.

Agency Approvals

CSA Certificate

English

CSA Certificate

English