

# Xinger III

## Hybrid Coupler 3 dB, 90°

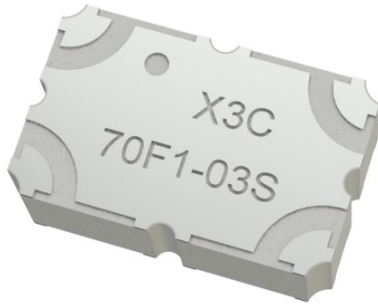

### Description:

The X3C70F1-03S is a low profile, high performance 3dB hybrid coupler, with a power rating of 15 Watts (AVG) and a peak to average ratio of 12dB, in a new easy to use, Xinger style manufacturing friendly surface mount package. It is designed particularly for 5G (n104), 6G and C-Band applications in all end markets including telecom and COTS Mil-Aero. The X3C70F1-03S is designed particularly for high frequency radio link and other applications where low insertion loss and tight amplitude and phase balance is required.

Parts have been subjected to rigorous Xinger qualification testing and they are manufactured using materials with coefficients of thermal expansion (CTE) compatible with common substrates such as FR4, G-10, RF-35, RO4003 and polyimide. Produced with 6 of 6 RoHS compliant tin immersion finish.

### Features:

- 5500-8500 MHz
- 5G (n104), 6G and C-Band COTS Mil-Aero
- Power 15 Watts (AVG)
- Peak to Average Ratio 12dB
- Very Low Loss (<0.25dB)
- Tight Amp Bal (<0.30dB)
- High Isolation (>23dB)
- Production Friendly
- Tape and Reel
- Lead-Free

### Electrical Specifications\*:

Frequency	Isolation	Insertion Loss	VSWR	Amplitude Balance
MHz	dB Min	dB Max	Max : 1	dB Max
5500-8500	23	0.25	1.15	0.30
Group Delay	Phase	Power	Operating Temp.	
ns	Degrees	Avg. Watts at 95°C	°C	
0.06±0.04	4.0	15	-55 to +150	

\*Specification based on performance of unit properly installed on TTM Test Board with small signal applied. Specifications subject to change without notice. Refer to parameter definitions for details

### Mechanical Outline:

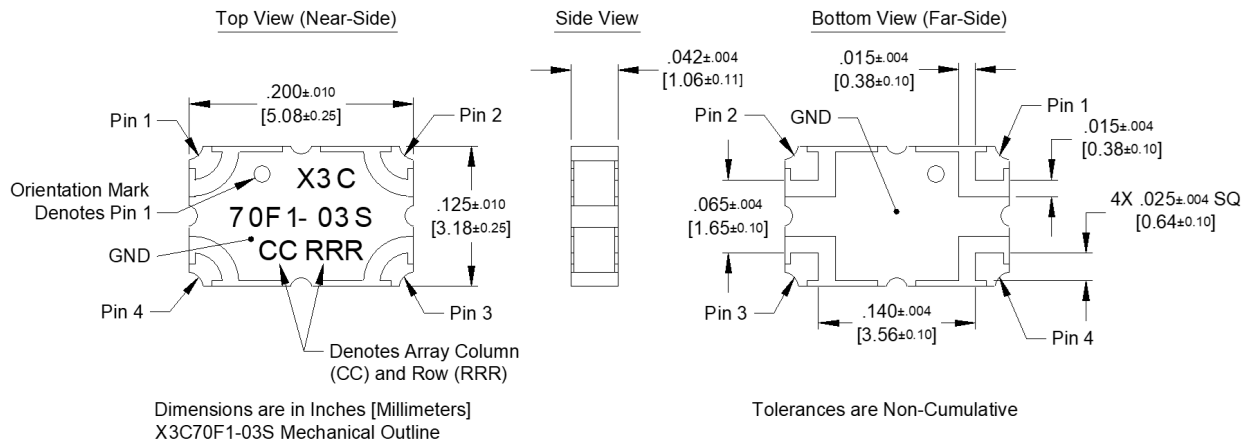

### Hybrid Coupler Pin Configuration:

The X3C70F1-03S has an orientation marker to denote Pin 1. Once port one has been identified the other ports are known automatically. Please see the chart below for clarification:

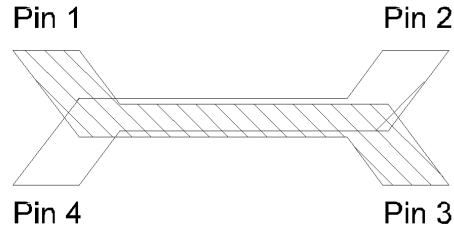

Configuration	Pin 1	Pin 2	Pin 3	Pin 4
Splitter	Input	Isolated	-3dB $\angle\theta - 90$	-3dB $\angle\theta$
Splitter	Isolated	Input	-3dB $\angle\theta$	-3dB $\angle\theta - 90$
Splitter	-3dB $\angle\theta - 90$	-3dB $\angle\theta$	Input	Isolated
Splitter	-3dB $\angle\theta$	-3dB $\angle\theta - 90$	Isolated	Input
*Combiner	A $\angle\theta - 90$	A $\angle\theta$	Isolated	Output
*Combiner	A $\angle\theta$	A $\angle\theta - 90$	Output	Isolated
*Combiner	Isolated	Output	A $\angle\theta - 90$	A $\angle\theta$
*Combiner	Output	Isolated	A $\angle\theta$	A $\angle\theta - 90$

\*Notes: "A" is the amplitude of the applied signals. When two quadrature signals with equal amplitudes are applied to the coupler as described in the table, they will combine at the output port. If the amplitudes are not equal, some of the applied energy will be directed to the isolated port.

### Peak Power Handling:

High-Pot testing of these couplers during the qualification procedure resulted in a minimum breakdown voltage of 0.99Kv (minimum recorded value). This voltage level corresponds to a breakdown resistance capable of handling at least 12dB peak over average power levels, for very short durations. The breakdown location consistently occurred across the air interface at the coupler contact pads (see illustration below). The breakdown levels at these points will be affected by any contamination in the gap area around these pads. These areas must be kept clean for optimum performance. It is recommended that the user test for voltage breakdown under the maximum operating conditions and over worst case modulation induced power peaking. This evaluation should also include extreme environmental conditions (such as high humidity).

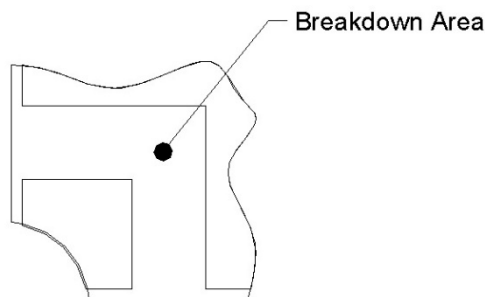

## Insertion Loss and Power Derating Curves:

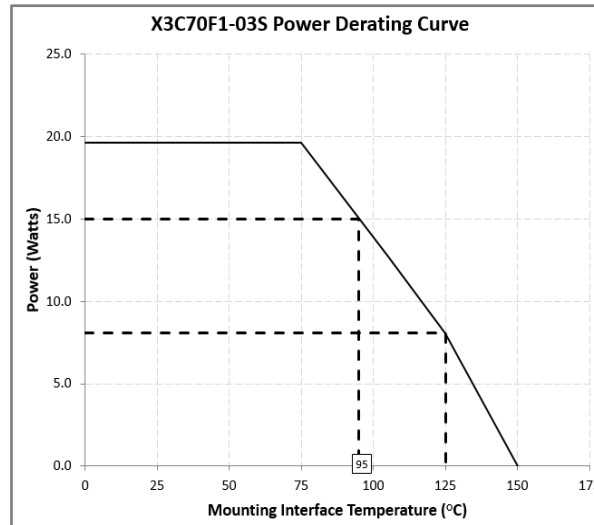
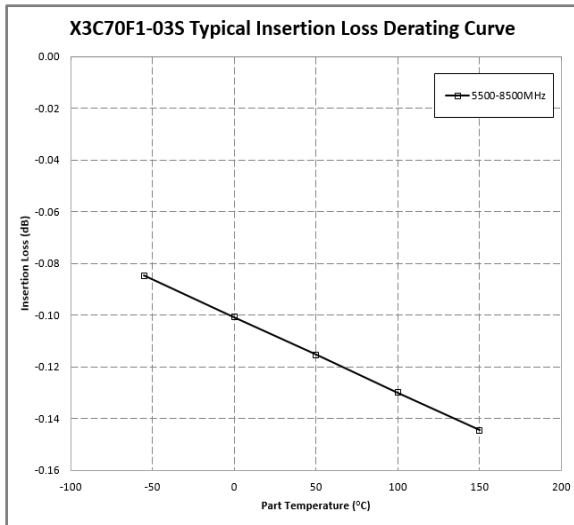

### Insertion Loss Derating:

The insertion loss, at a given frequency, of the coupler is measured at 25°C and then averaged. The measurements are performed under small signal conditions (i.e. using a Vector Network Analyzer). The process is repeated at -55°C, 95°C and 150°C. A best-fit line for the measured data is computed and then plotted from -55°C to 150°C.

### Power Derating:

The power handling and corresponding power derating plots are a function of the thermal resistance, mounting surface temperature (base plate temperature), maximum continuous operating temperature of the coupler, and the thermal insertion loss. The thermal insertion loss is defined in the Power Handling section of the data sheet.

As the mounting interface temperature approaches the maximum continuous operating temperature, the power handling decreases to zero.

If mounting temperature is greater than 95°C, the Xinger coupler will perform reliably as long as the input power is derated to the curve above.

**Typical Performance: 5500 to 8500 MHz**

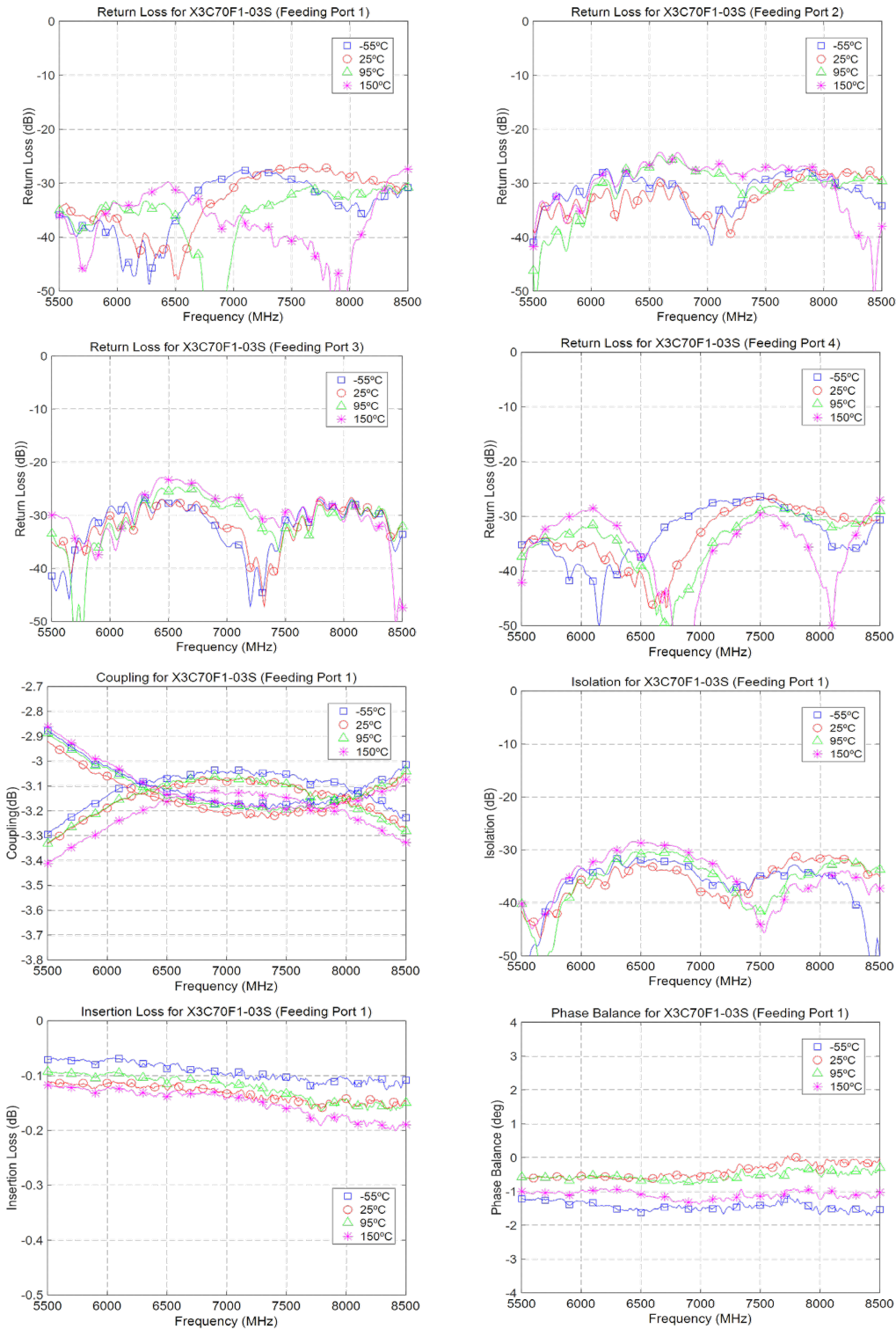

**Definition of Measured Specifications:**

Parameter	Definition	Mathematical Representation
<b>VSWR</b> (Voltage Standing Wave Ratio)	The impedance match of the coupler to a 50Ω system. A VSWR of 1:1 is optimal.	$VSWR = \frac{V_{max}}{V_{min}}$ Vmax = voltage maxima of a standing wave Vmin = voltage minima of a standing wave
<b>Return Loss</b>	The impedance match of the coupler to a 50Ω system. Return Loss is an alternate means to express VSWR.	$Return\ Loss(dB) = 20\log \frac{VSWR + 1}{VSWR - 1}$
<b>Insertion Loss</b>	The input power divided by the sum of the power at the two output ports.	$Insertion\ Loss(dB) = 10\log \frac{P_{in}}{P_{cpl} + P_{direct}}$
<b>Isolation</b>	The input power divided by the power at the isolated port.	$Isolation(dB) = 10\log \frac{P_{in}}{P_{iso}}$
<b>Phase Balance</b>	The difference in phase angle between the two output ports.	Phase at coupled port – Phase at direct port
<b>Amplitude Balance</b>	The power at each output divided by the average power of the two outputs.	$10\log \frac{P_{cpl}}{(P_{cpl} + P_{direct})/2} \text{ and } 10\log \frac{P_{direct}}{(P_{cpl} + P_{direct})/2}$

**Packaging and Ordering Information:**

Parts are available in reels. Packaging follows EIA 481 for reels. Parts are oriented in tape and reel as shown below. Tape and reel is available in 4000 pcs per reel.

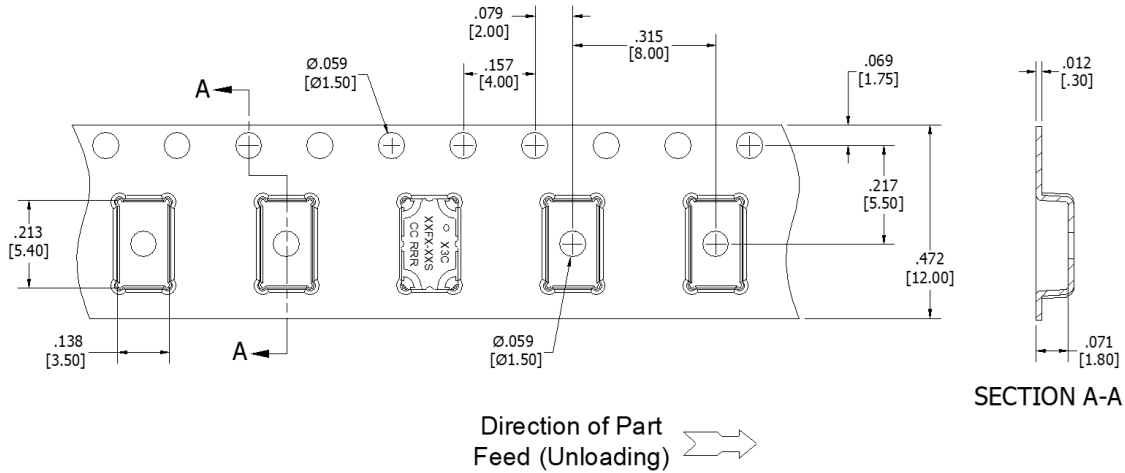

Dimensions are in Inches [Millimeters]

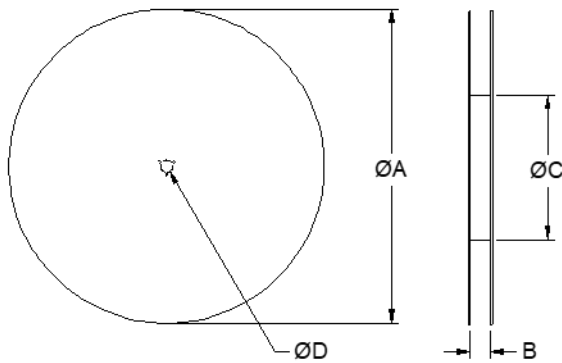

TABLE 1 REEL DIMENSIONS (Inches[mm])	
ØA	13.0 [330.0]
B	.472 [12.0]
ØC	4.017 [102.03]
ØD	.512 [13.0]

**Contact us:**  
[rf&s\\_support@ttm.com](mailto:rf&s_support@ttm.com)