



NOTE

All numerical values are in metric units [with U.S. customary units in brackets]. Dimensions are in millimeters. Unless otherwise specified, dimensions have a tolerance of ± 0.13 and angles have a tolerance of $\pm 2^\circ$. Figures are not drawn to scale.

1. INTRODUCTION

This specification covers the requirements for application of the 3.9-mm pitch 85-ohm, 92-Ohm and 100-ohm STRADA Whisper connector system. The connector system uses a modular concept and interconnects two printed circuit (pc) boards. The connectors are available in double-end wall (DEW) and open-end (OE) vertical press-fit pin header and right-angle and vertical press-fit receptacle connected to the pc board via eye-of-needle (EON) compliant pin press-fit contacts. Differential pairs are arranged pair in-row (PiR) or pair in-column (PiC) depending on the application. Available connector sizes are given in Figure 1.

When mating, connector alignment features help align contacts prior to engagement of the connectors. For PiR connectors, the header alignment bosses fit into the receptacle alignment slots, which have a guide feature. For PiC connectors, receptacle alignment bosses fit into the pin header alignment slots with a guide feature. In addition, universal guide hardware is available and should be used with the connectors to provide error-free mating and prevent damage to the connector housings and contacts. The female guide module and male guide pin are designed to be installed onto the pc board. These guides are also recommended for multi-connector, large and heavy daughtercard applications, and conditions where the misalignment tolerances cannot be met. The male guide pin is available with internal or external threading. Keyed versions of the guide pin and module are also available. Basic terms and features of this product are provided in Figure 1.

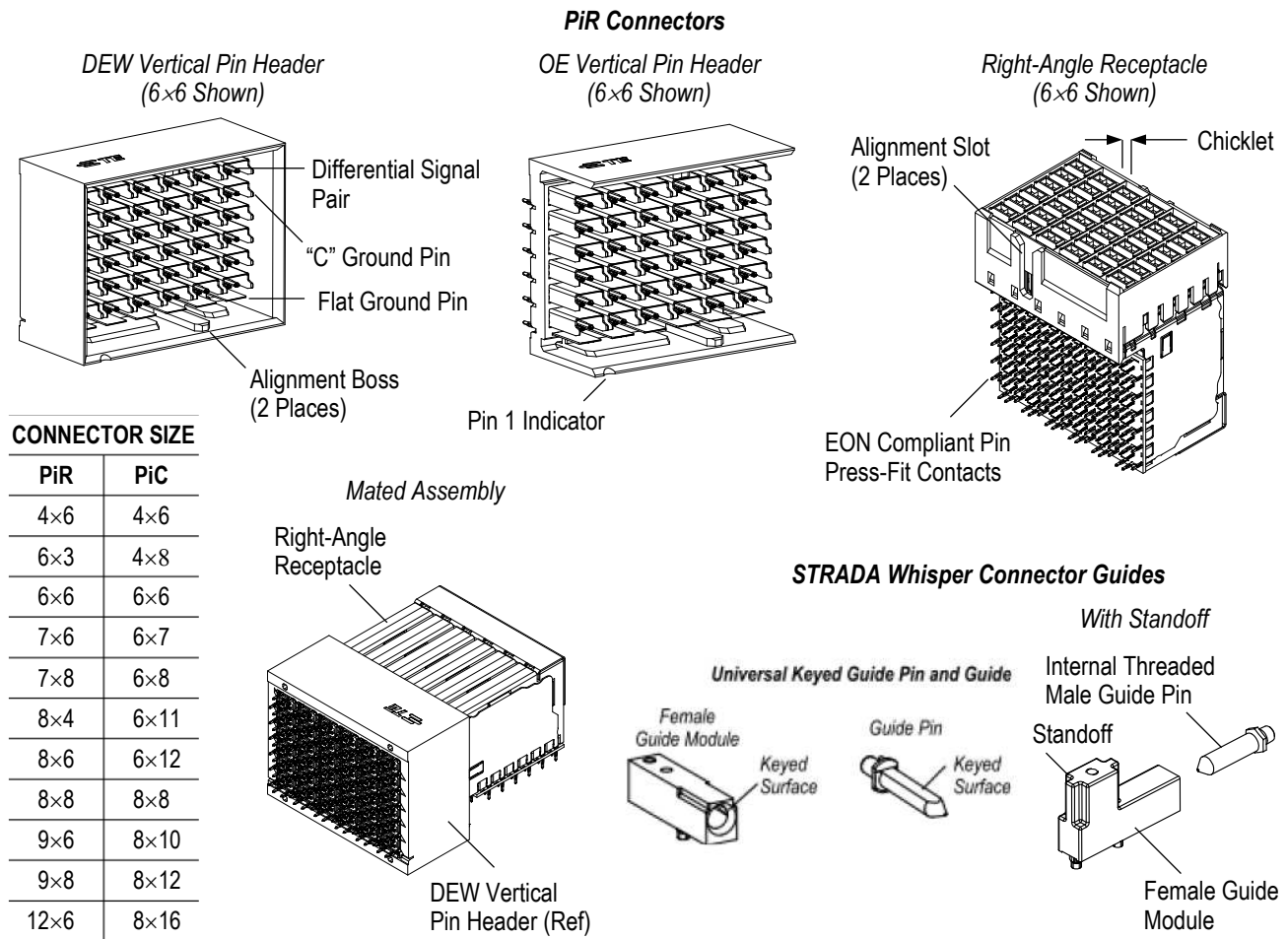

Figure 1 (Con'td)

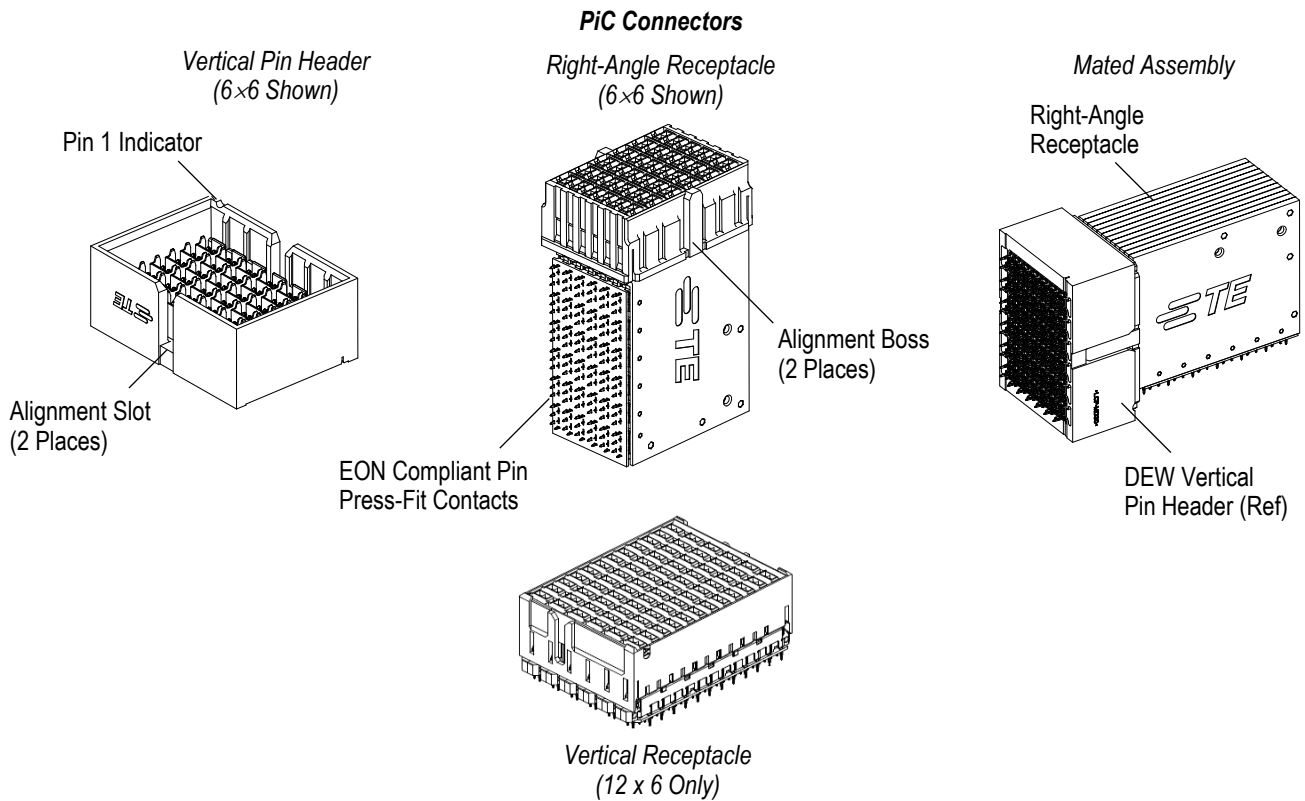

Figure 1 (End)

2. REFERENCE MATERIAL

2.1. Revision Summary

Revisions to this application specification include:

- Corrected formatting in section 3.4

2.2. Customer Assistance

The reference Product Base Part Numbers listed below and Product Codes L803 (pin headers), M284 (receptacles), M285 (miscellaneous assemblies), M286 (components), and 3083 (UPM) are representative of 3.9-mm pitch 85-ohm, 92-Ohm and 100-ohm STRADA Whisper connector system. Use of these numbers will identify the product line and help you to obtain product and tooling information when visiting www.te.com or calling the number at the bottom of page 1.

85-ohm connectors:

2274854 (PiC pin header)

2274853 (PiC receptacle)

2187554 (PiR pin header)

2187555 (PiR receptacle)

92-ohm connectors:

2187738 (PiR pin header)

2187232 (PiR receptacle)

100-ohm connectors

2198200 (PiC pin header)

2198174 (PiC receptacle)

2187476 (PiR pin header)

2187232 (PiR receptacle)

2187626 (PiR vertical receptacle)

Optional STRADA Whisper connector guides: 2149782 (female guide module)

2149783 (male guide pin)

UPM connector guides:

5223986 (female guide module)

5223985 (male guide pin)

2.3. Drawings

Customer drawings for product part numbers are available from www.te.com. Information contained in the customer drawing takes priority.

2.4. Specifications

Product Specification [108-32021](#) and 108-140186 provides expected product performance and test results.

2.5. Instructional Material

Instruction sheets (408-series) provide product assembly instructions. Instructional material that pertain to this product are:

[408-32054](#) Removal Tool Kits for STRADA Whisper Receptacles

[408-32059](#) Removal Tool Kits for STRADA Whisper Pin Headers

3. REQUIREMENTS

3.1. Storage

A. Shelf Life

The product should remain in the shipping containers until ready for use to prevent deformation to components. The product should be used on a first in, first out basis to avoid storage contamination that could adversely affect performance.

Connectors that are removed from the shipping container (tube or tray), but not used, must be carefully placed back into the original container as soon as possible.

B. Chemical Exposure

Do not store product near any chemical listed below as they may cause stress corrosion cracking in the material.

Alkalies	Ammonia	Citrates	Phosphates	Citrates	Sulfur Compounds
Amines	Carbonates	Nitrites	Sulfur	Nitrites	Tartrates

3.2. Material

The housings and chicklets are molded of high-temperature, UL94V-0 rated thermoplastic. The contacts are made of copper alloy and plated at the contact interface with precious metal. All contacts have a nickel underplate and tin plated press-fit leads. Refer to the specific customer drawing for details.

3.3. Pin Lengths

The lengths of the pins are given in Figure 2.

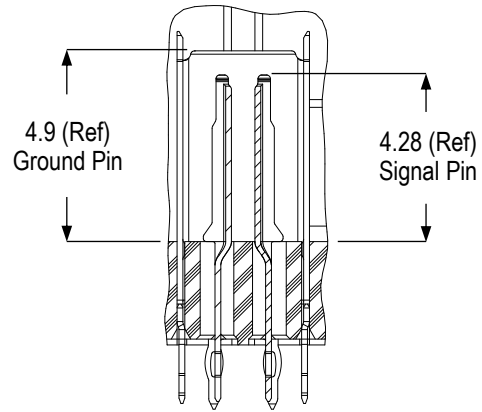

Note: Contact TE Connectivity (TE) for other pin lengths.

Figure 2

3.4. PC Board

A. Material and Thickness

The pc board material shall be glass epoxy (FR-4, ref).

For connector compliant pins, the daughtercard and backplane must have a minimum thickness of 1.25, and the mid-plane must have a minimum thickness of 4.00. For pc boards with a thickness less than 2, a pc board support must be positioned directly under the connector area.

To accommodate an internally-threaded STRADA Whisper connector male guide pin, the pc board must have a thickness equal to or greater than the thread length of the male guide pin. To accommodate an externally-threaded STRADA Whisper connector male guide pin, the pc board must have a thickness less than the thread length of the male guide pin. A pc board support must be positioned directly under the connector area.

When using STRADA Whisper connector female guide modules on a pc board with a thickness less than 4.5, a pc board support must be positioned directly under the connector area.

i **NOTE**
All pc board supports must meet the requirements described in Section 5.

B. Layout

The pc board layouts are provided on the specific connector customer drawing.

C. Hole Configuration

The holes in the pc board for all contacts must be drilled and plated through to the dimensions given in Figure 3. Dimension for pc boards that are to be back-drilled (counterbored) for signal integrity performance is also given.

i **NOTE**
The nominal finished hole diameter (dimension A) is supplied for reference only. Although it may be used as an inspection dimension, proper plated through hole (PTH) composition can only be determined via radial and longitudinal cross sectioning of the PTH. Radial sectioning verifies that the specified PTH component dimensions are achieved, i.e., drill diameter, copper plating, and other specified plating thicknesses. Longitudinal sectioning will verify plating uniformity throughout the pc board thickness. Deviation from the requirements listed in Figure 3 may have adverse effects on compliant pin insertion force and related performance.

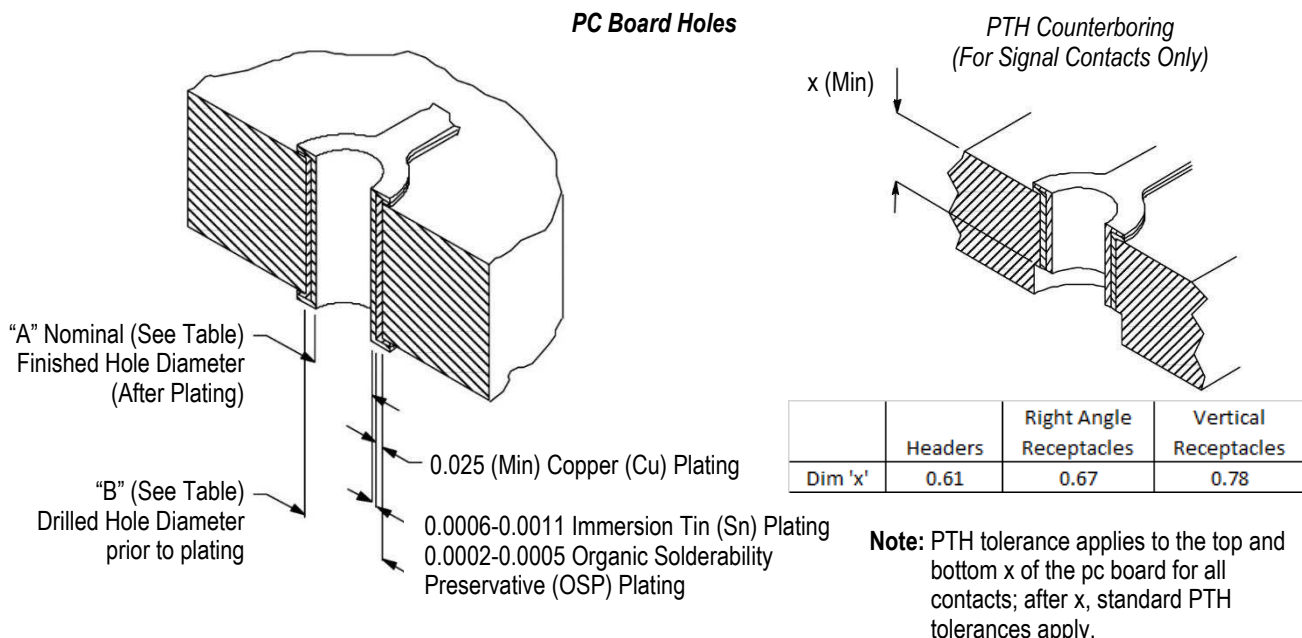

Figure 3 (Cont'd)

CONNECTOR					DIMENSION		
UNIT	CONTACT ARRANGEMENT	TYPE	FOOTPRINT	CONTACT TYPE	A	B±0.025	
85-Ohm 92-Ohm	PiR	Receptacle	All	Signal	0.29±0.05	0.368	
				Ground and SI Via	0.37±0.05	0.45	
		Pin Header	Backplane and Mid-Plane	Signal	0.37±0.05	0.45	
				Ground and SI Via	0.37±0.05	0.45	
			Routable Mid-Plane	Signal	0.32±0.05	0.40	
				Ground and SI Via	0.32±0.05	0.40	
	PiC	Pin Header	Standard	Signal	0.32±0.05	0.40	
				Ground and SI Via	0.32±0.05	0.40	
				Signal and SI Via	0.27±0.04	0.368	
		Receptacle		Ground	0.36±0.05	0.45	
				Side Routing	Signal	0.29±0.05	0.368
					Ground and SI Via	0.37±0.05	0.45
	Pin Header	Wide Routing Channel	Signal	0.36±0.05	0.45		
			Ground and SI Via	0.36±0.05	0.45		
100-Ohm	PiR	Receptacle	All	Signal	0.24±0.04	0.32	
				Ground	0.34±0.05	0.42	
				SI Via	0.22 (Ref)	0.30	
		Vertical Receptacle	All	Signal	0.34±0.05	0.42	
				Ground and SI Via	0.37±0.05	0.45	
				Pin Header	All	Signal	0.34±0.05
	Ground and SI Via	0.37±0.05	0.45				
	PiC	Receptacle	All	Signal	0.24±0.04	0.32	
				Ground and SI Via	0.37±0.05	0.45	
		Pin Header		Signal	0.34±0.05	0.42	
Ground and SI Via				0.37±0.05	0.45		

Figure 3 (End)

D. Connector Spacing



NOTE

When using these connectors with other connectors or components, call the number at the bottom of page 1 for the recommended spacing.

Recommended spacing for connectors with universal power modules is given in Figure 4.

**Recommended Spacing for 85-Ohm, 92-Ohm and 100-Ohm
PiR DEW Vertical Pin Headers and PiR Right-Angle Receptacles With Universal Power Modules**

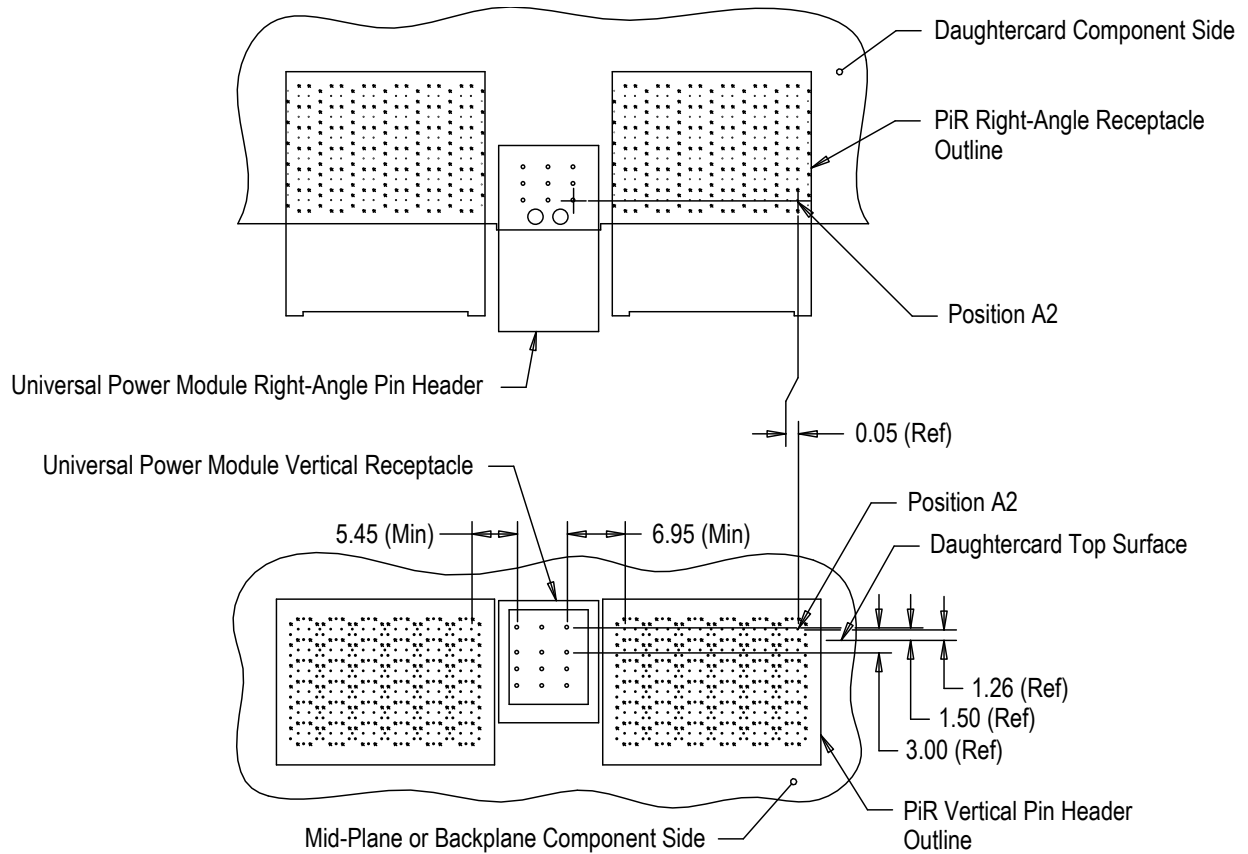

Note: Connector footprint true position requirements are given on the customer drawings.

POWER MODULE OPERATING VOLTAGE	DIMENSION A (Min)
50 V	1.2
250 V	2.5

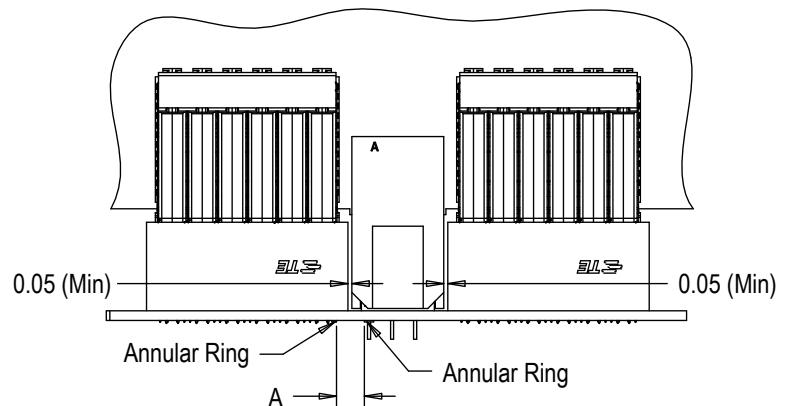
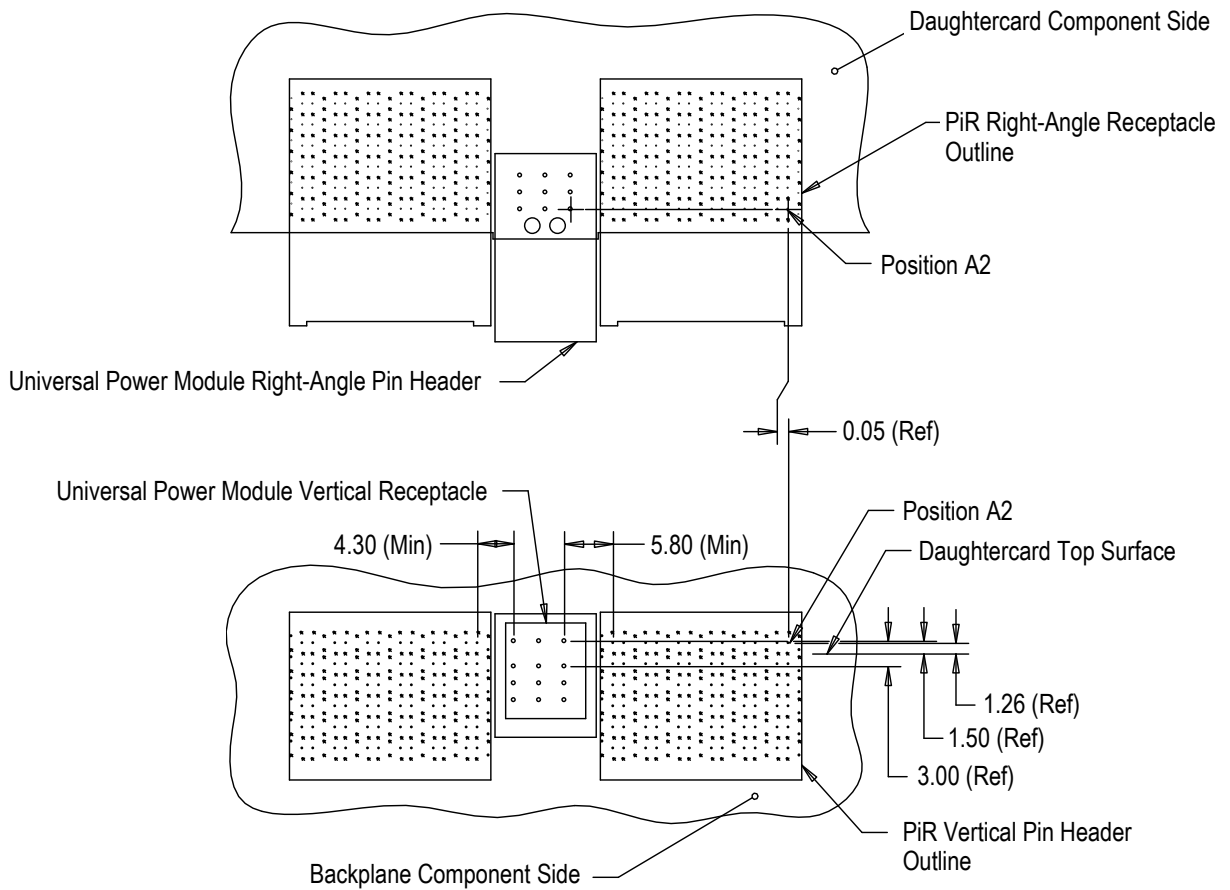

Figure 4 (Con'td)

**Recommended Spacing for 85-Ohm, 92-Ohm and 100-Ohm
PiR OE Vertical Pin Headers and PiR Right-Angle Receptacles With Universal Power Modules**



Note: Connector footprint true position requirements are given on the customer drawings.

POWER MODULE OPERATING VOLTAGE	DIMENSION A (Min)
50 V	1.2
250 V	2.5

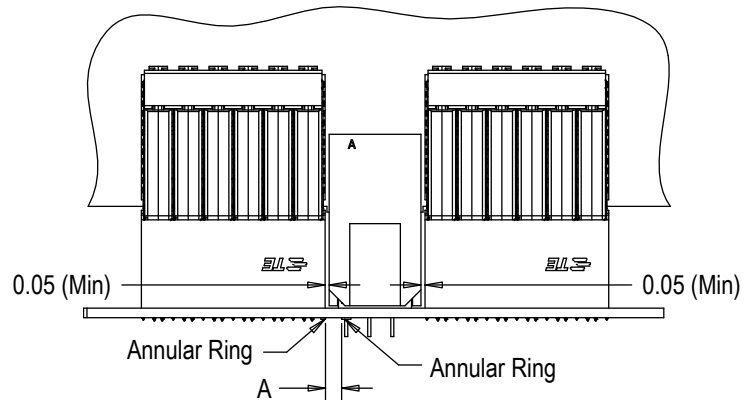

Figure 4 (Cont'd)

**Recommended Spacing for 85-Ohm & 92 Ohm
PiC Standard Routing Channel Vertical Pin Headers and PiC Side Routing Right-Angle Receptacles
With Universal Power Modules**

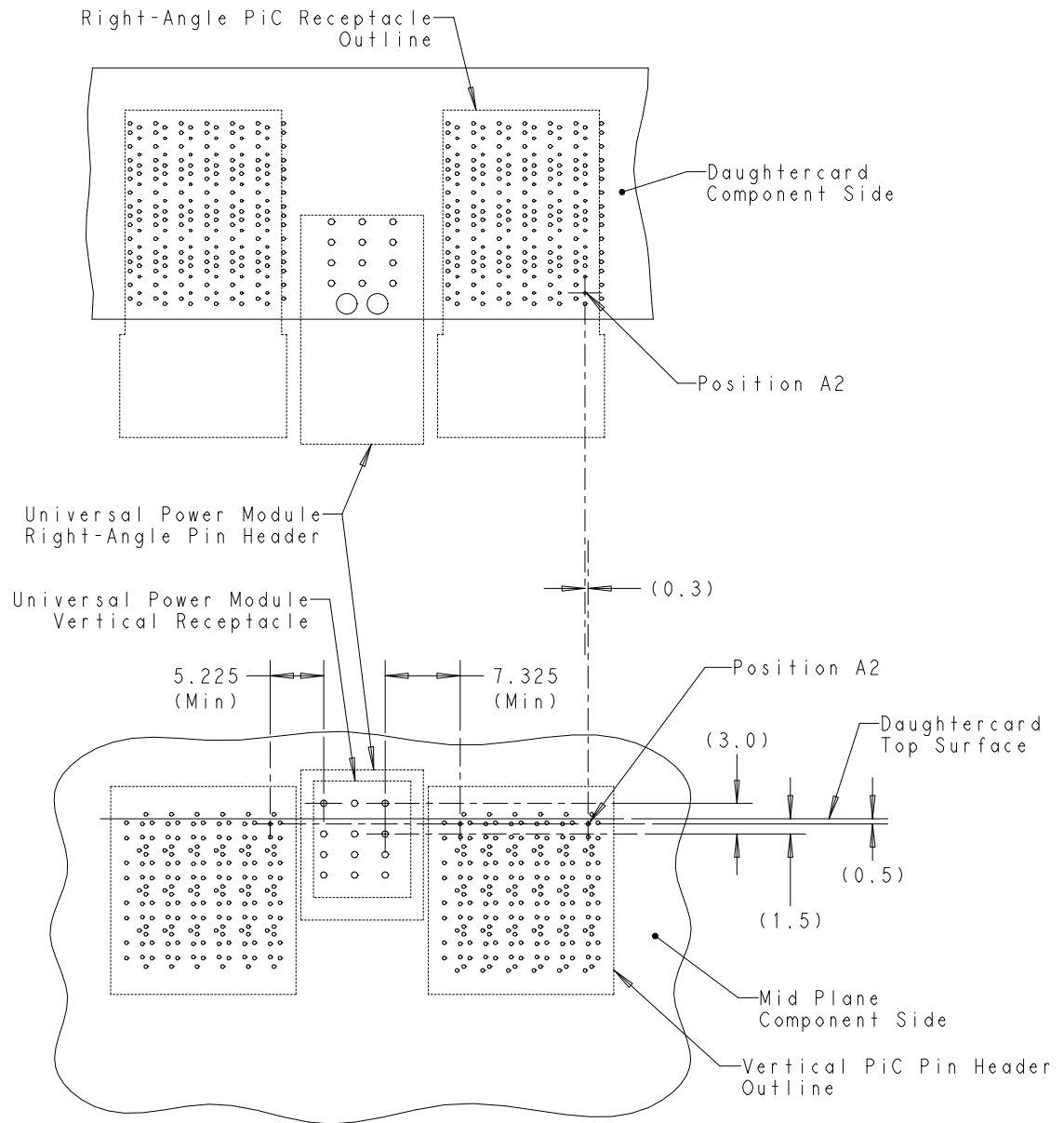
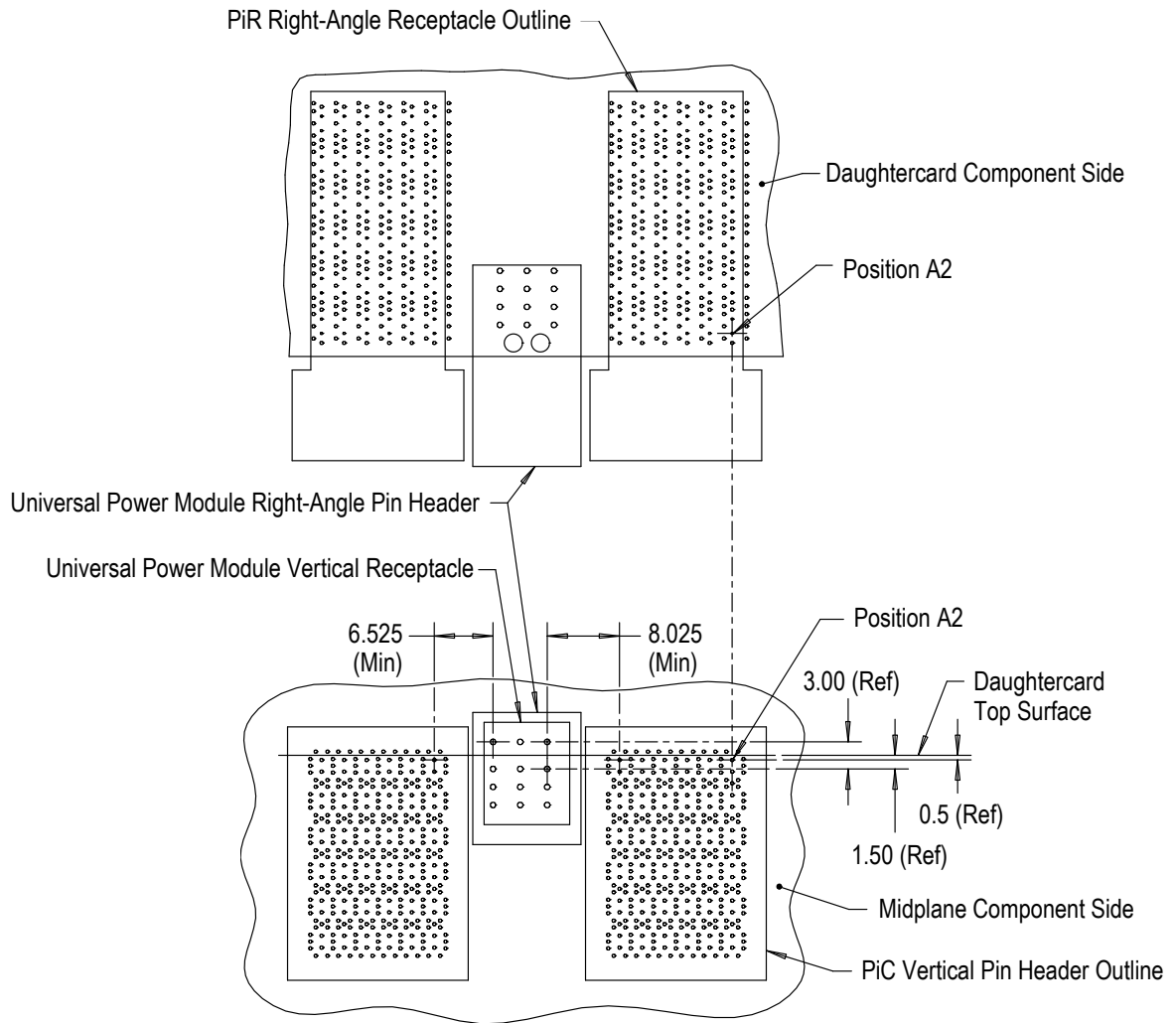

Figure 4 (Cont'd)

**Recommended Spacing for 100-Ohm
PiC Vertical Pin Headers and PiC Right-Angle Receptacles With Universal Power Modules**



Note: Connector footprint true position requirements are given on the customer drawings.

POWER MODULE OPERATING VOLTAGE	DIMENSION A (Min)
50 V	1.2
250 V	2.5

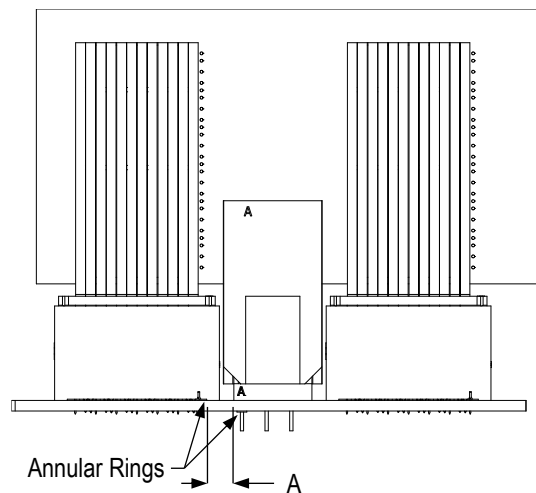
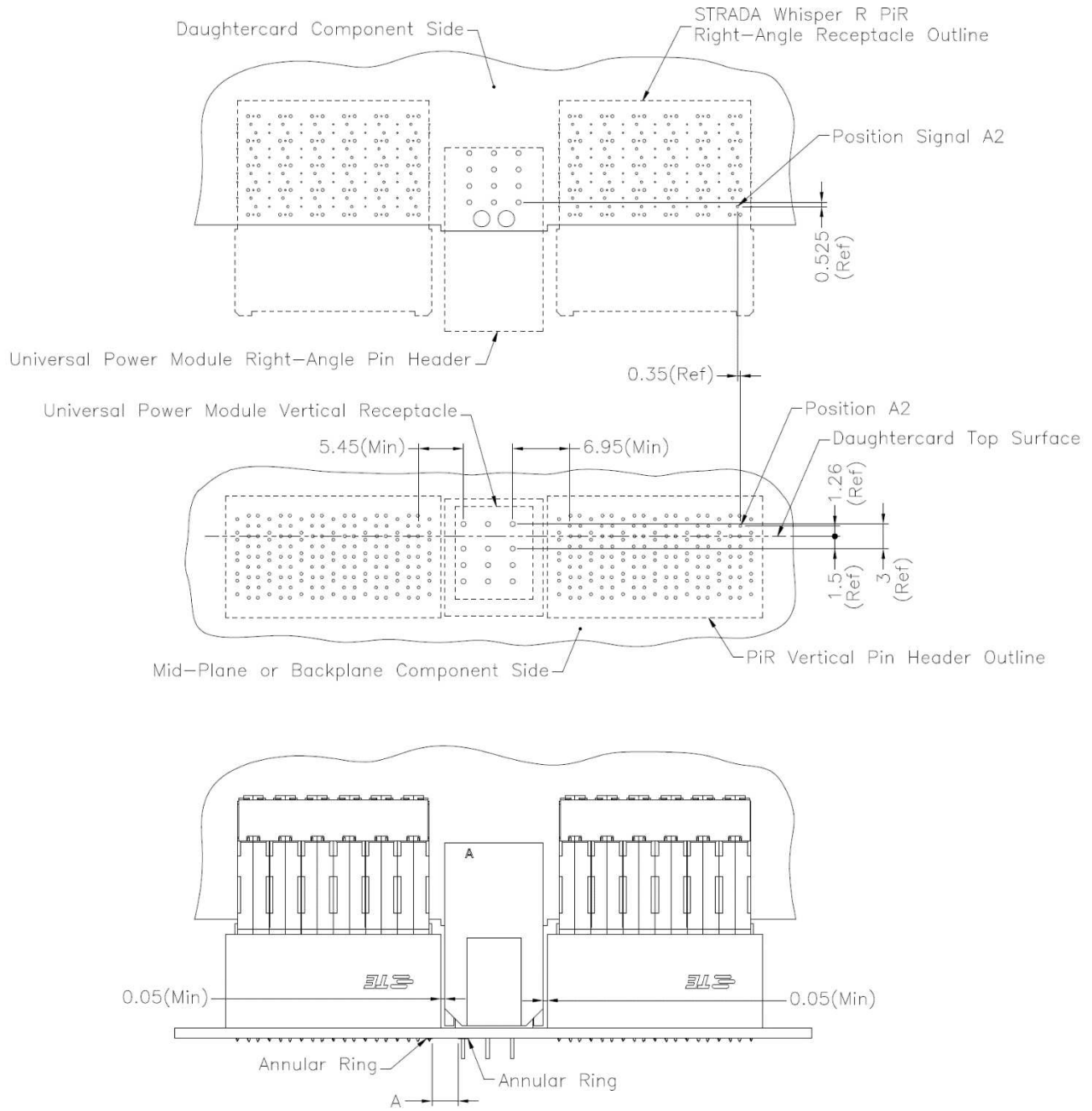

Figure 4 (End)

**Recommended Spacing for 92-Ohm
PiR DEW Vertical Pin Headers and STRADA Whisper R PiR Right-Angle Receptacles
With Universal Power Modules**



Note: Connector footprint true position requirements are given on the customer drawings.

POWER MODULE OPERATING VOLTAGE	DIMENSION A (Min)
50 V	1.2
250 V	2.5

Figure 4 (Cont'd)

**Recommended Spacing for 92-Ohm
PiR OE Vertical Pin Headers and STRADA Whisper R PiR Right-Angle Receptacles
With Universal Power Modules**

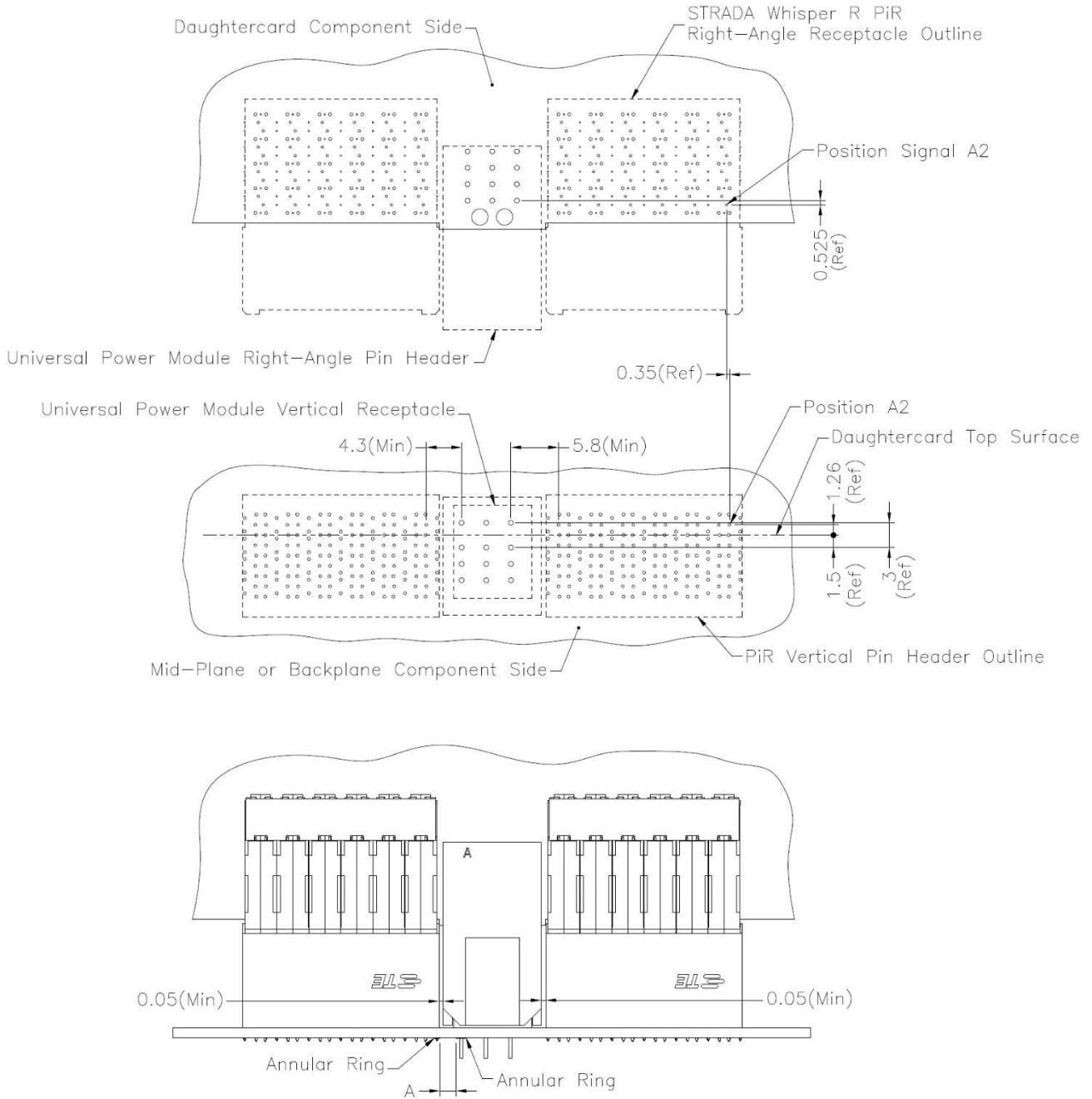

Note: Connector footprint true position requirements are given on the customer drawings.

POWER MODULE OPERATING VOLTAGE	DIMENSION A (Min)
50 V	1.2
250 V	2.5

Figure 4 (End)

3.5. Placement

A. Connector

Connectors can be placed on the pc board end-to-end within the dimensions given in Figure 5.

SI vias between adjacent pin headers may be removed for the placement given in Detail A. Refer to the specific connector customer drawing for placement of all remaining SI vias and size and position of the receptacle SI vias.

For the placement given in Details B, C, D, E, F, G, and H, all SI vias (including those between adjacent pin headers) must be sized and positioned according to the specific connector customer drawing. Receptacle SI vias may be sized and positioned according to Detail B if preferred over the placement given in Detail A and/or the customer drawing.

For mid-plane application, connectors may be placed according to the requirements given in Detail J.

For additional footprint requirements, refer to the specific connector customer drawing.

**End-to-End Stacked Spacing for 85-Ohm, 92-Ohm and 100-Ohm
PiR Right-Angle Receptacles with OE Vertical Pin Headers
Placement Detail A**

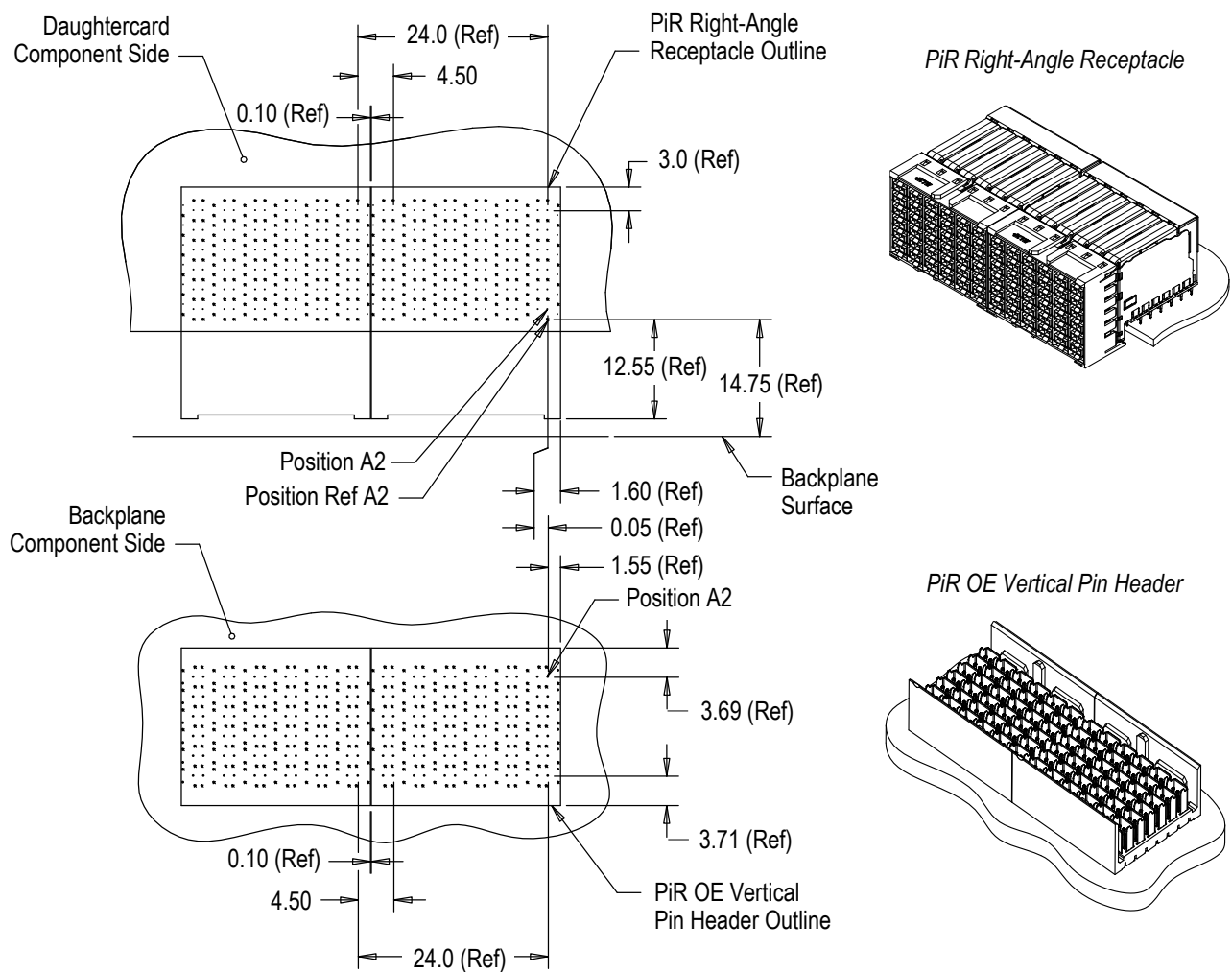

Figure 5 (Cont'd)

**Stand-Alone Spacing for 85-Ohm, 92-Ohm and 100-Ohm
PiR Right-Angle Receptacles with OE Vertical Pin Headers
Placement Detail B**

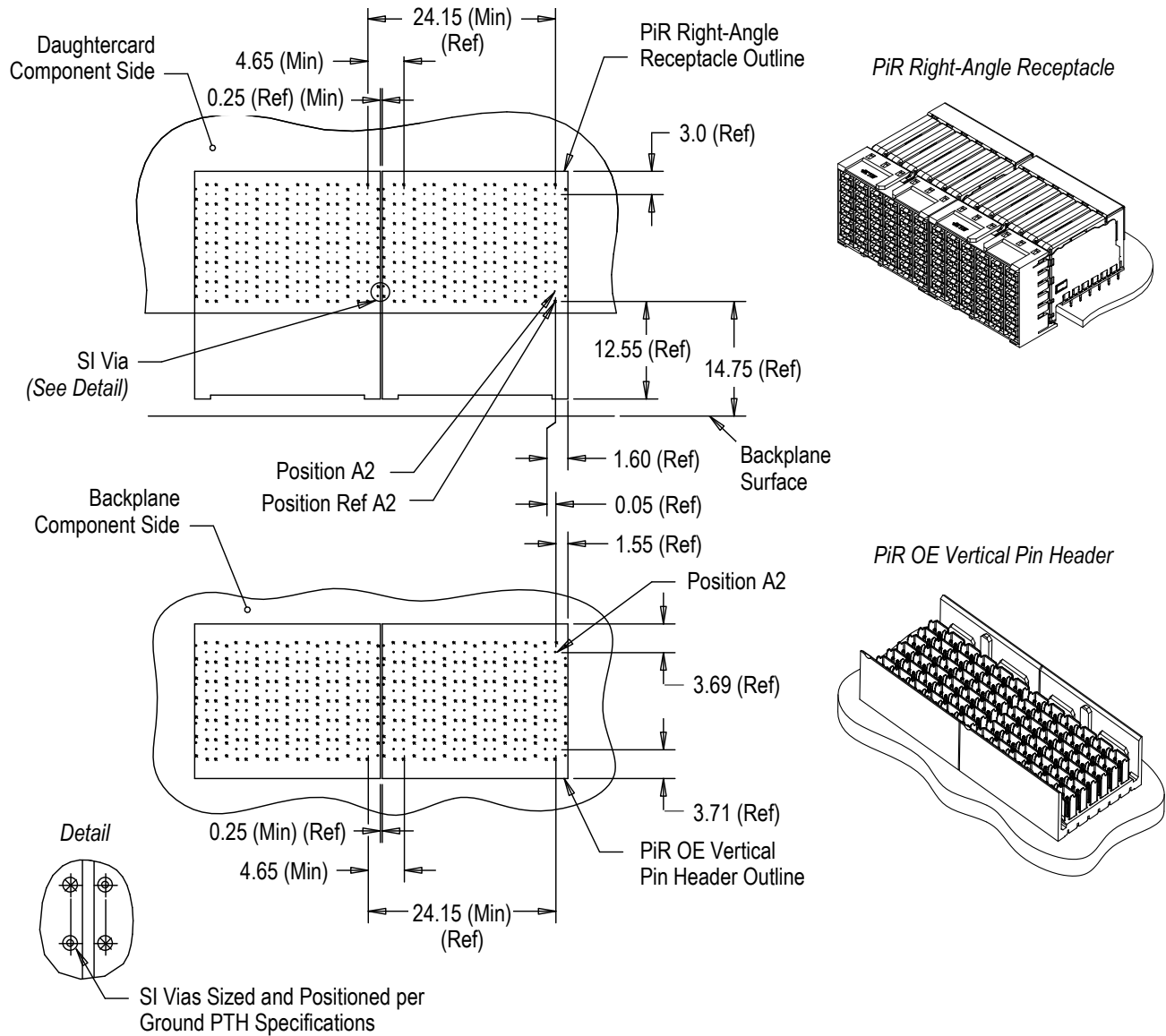

Figure 5 (Cont'd)

**Recommended Spacing for 85-Ohm, 92-Ohm and 100-Ohm
PiR Right-Angle Receptacles with DEW Vertical Pin Headers
Placement Detail C**

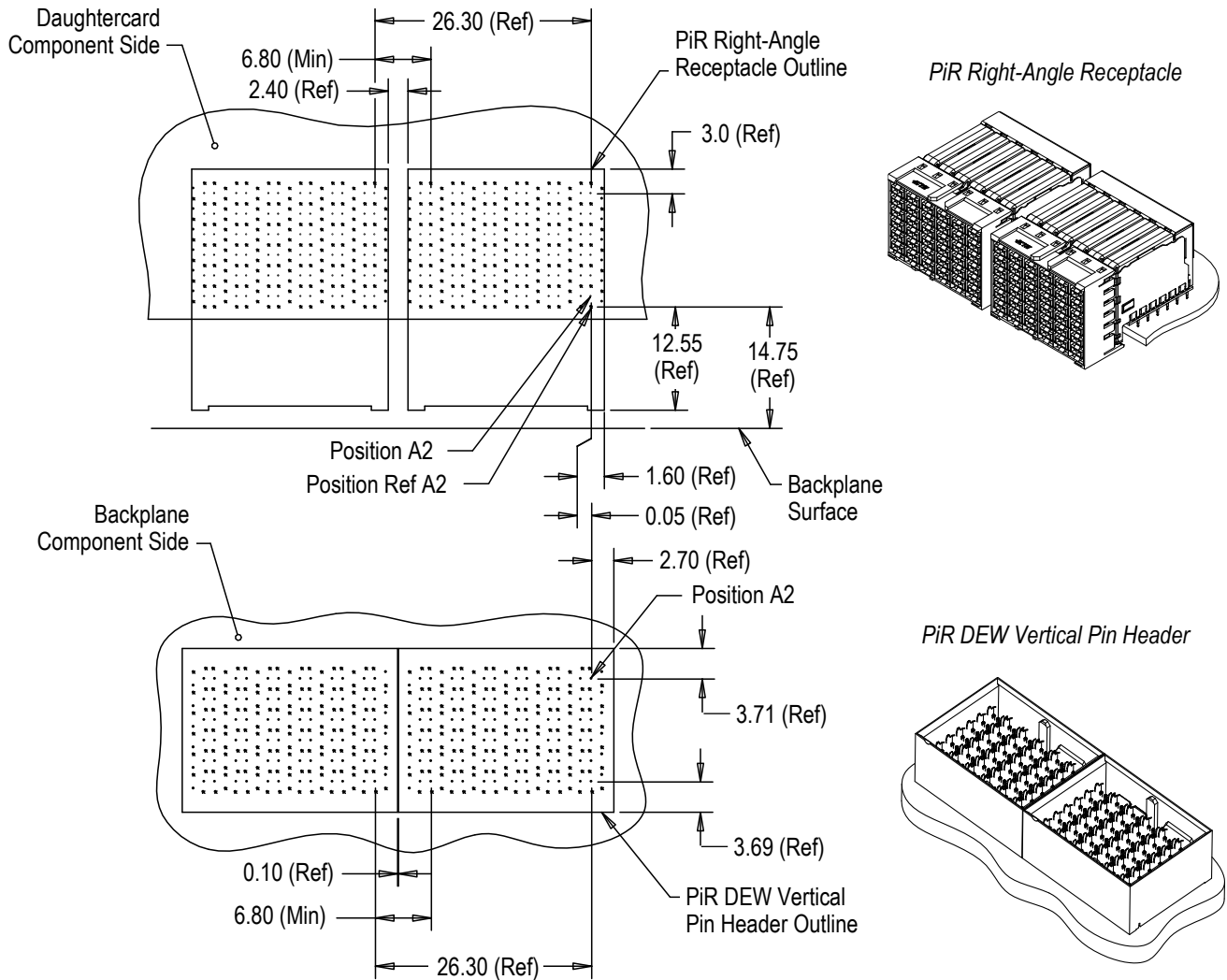

Figure 5 (Cont'd)

**Recommended Spacing for 85-Ohm & 92 Ohm
PiC Standard Routing Channel or Wide Routing Channel Vertical Pin Headers with PiC Side Routing Right-Angle Receptacles
Placement Detail D**

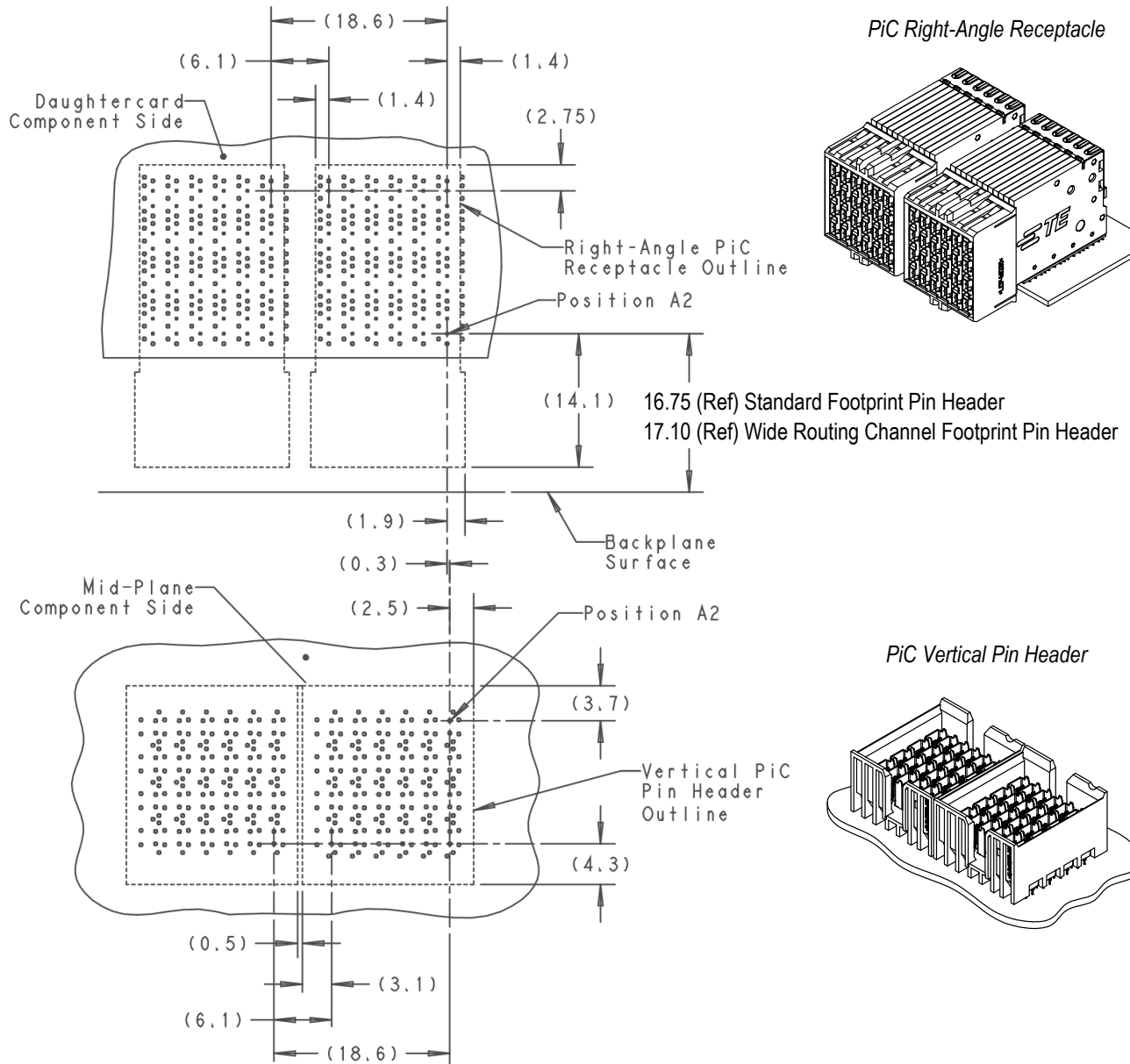
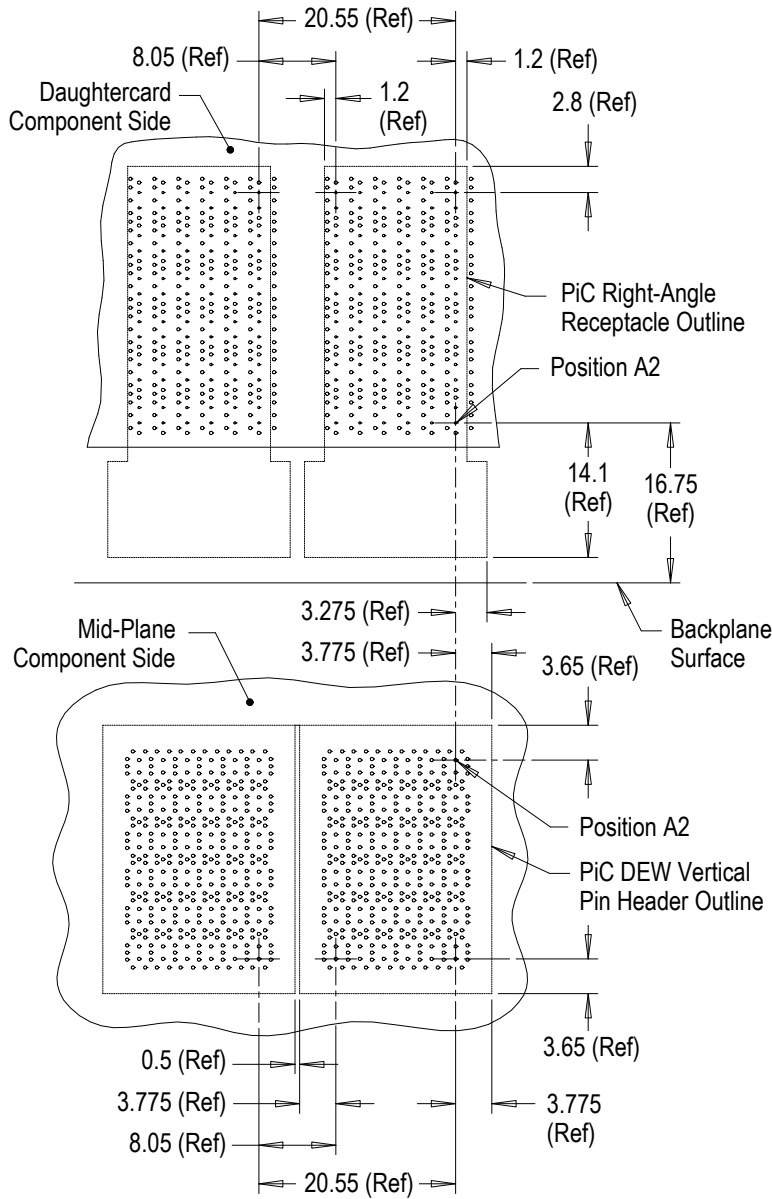
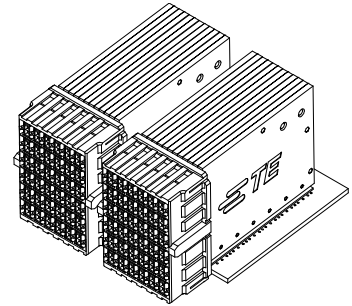

Figure 5 (Cont'd)

**Recommended Spacing for 100-Ohm
PiC Right-Angle Receptacles with DEW Vertical Pin Headers
Placement Detail E**



PiC Right-Angle Receptacle



PiC DEW Vertical Pin Header

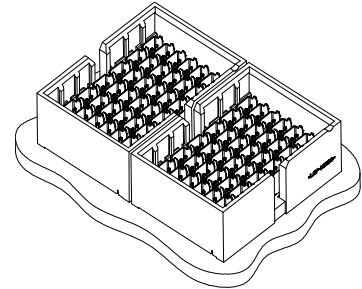

Note: Connector footprint true position requirements are given on customer drawings.

Figure 5 (Cont'd)

**Stand-Alone Spacing for 92-Ohm
STRADA Whisper R PiR Right-Angle Receptacles with OE Vertical Pin Headers
Placement Detail F**

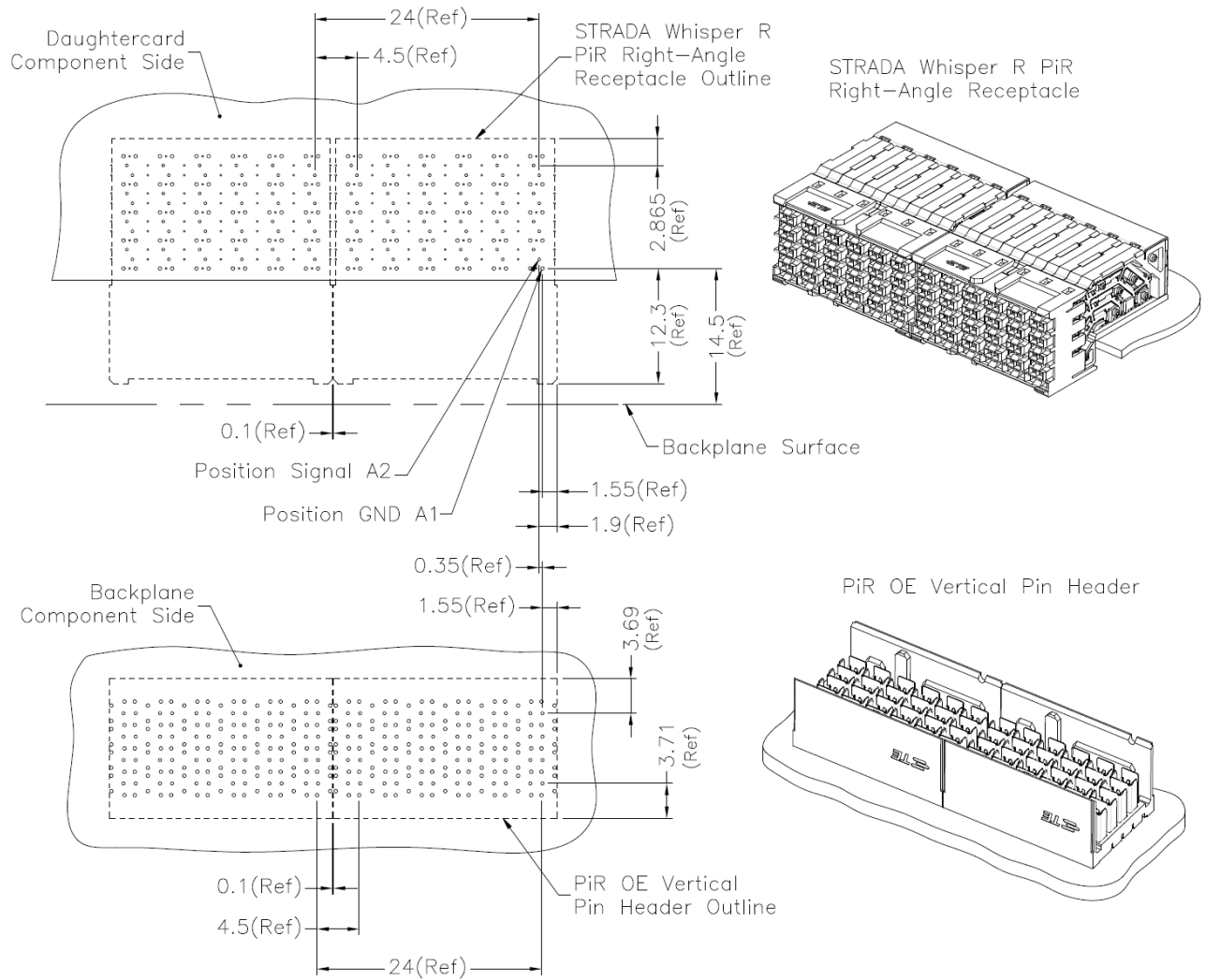

Figure 5 (Cont'd)

**Stand-Alone Spacing for 92-Ohm
STRADA Whisper R PiR Right-Angle Receptacles with OE Vertical Pin Headers
Placement Detail G**

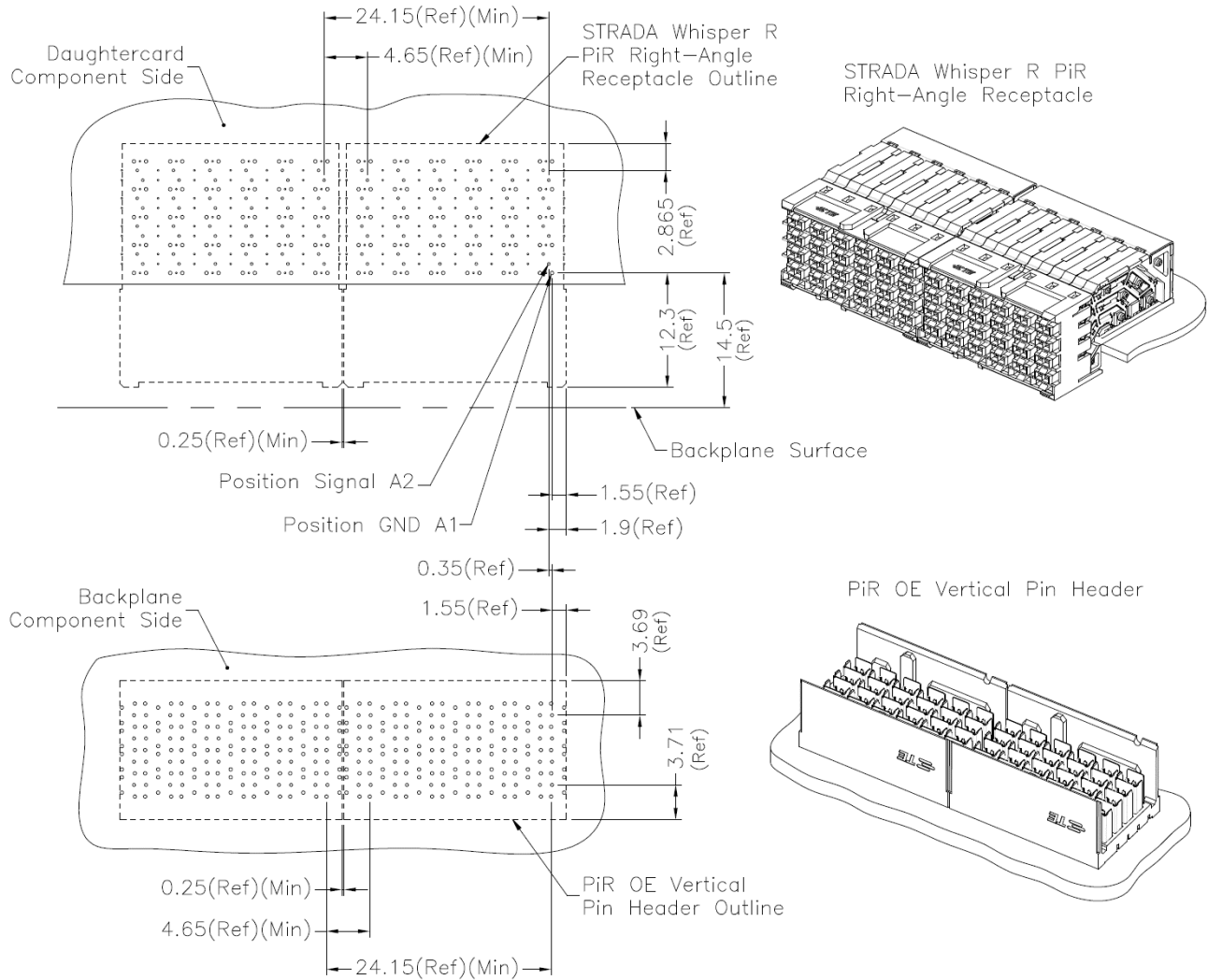

Figure 5 (Cont'd)

**Recommended Spacing for 92-Ohm
STRADA Whisper R PiR Right-Angle Receptacles with DEW Vertical Pin Headers
Placement Detail H**

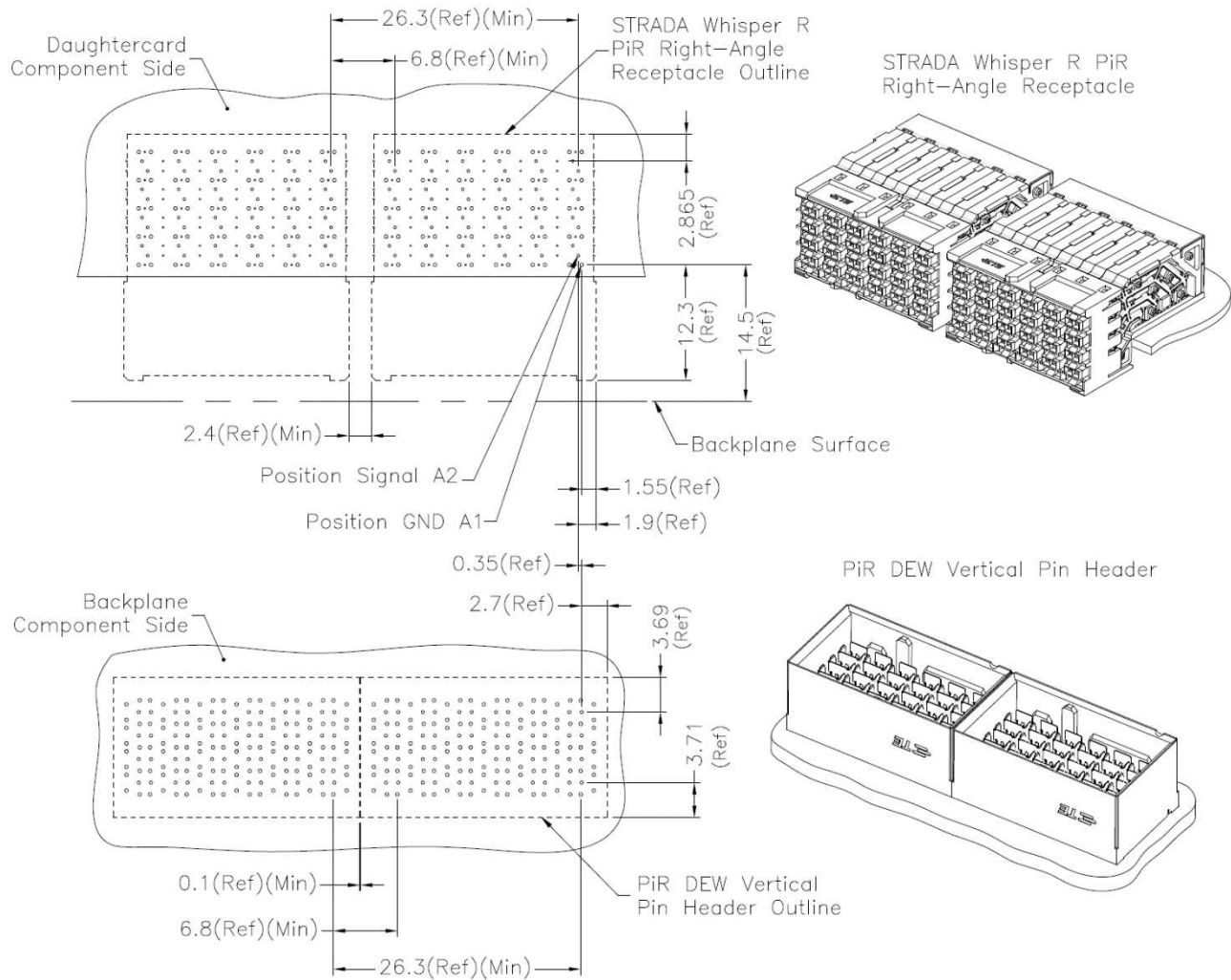

Figure 5 (Cont'd)

**Mid-Plane Application
Placement Detail J**

Note: For clarity, mid-plane not shown.

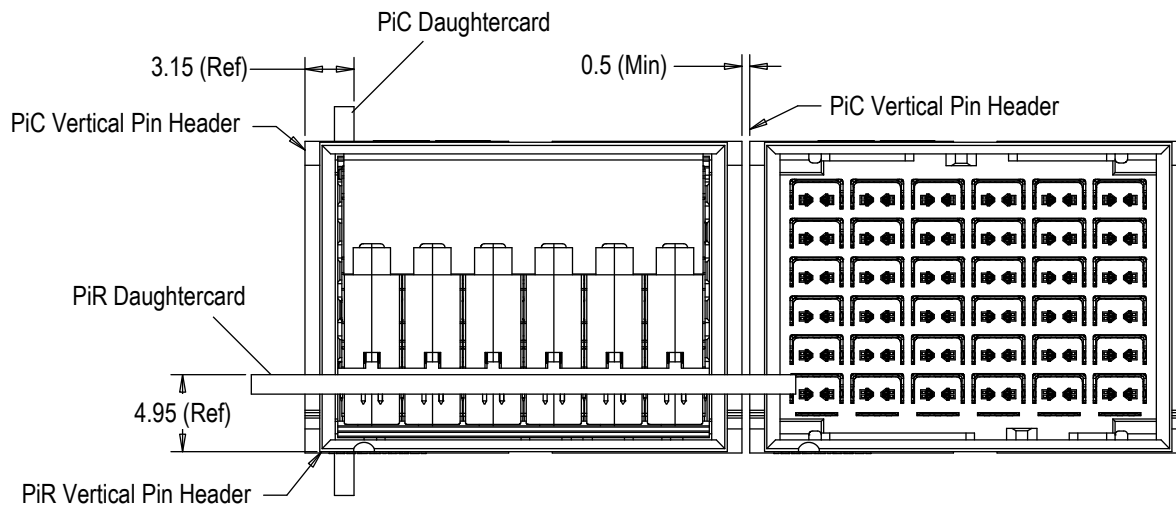
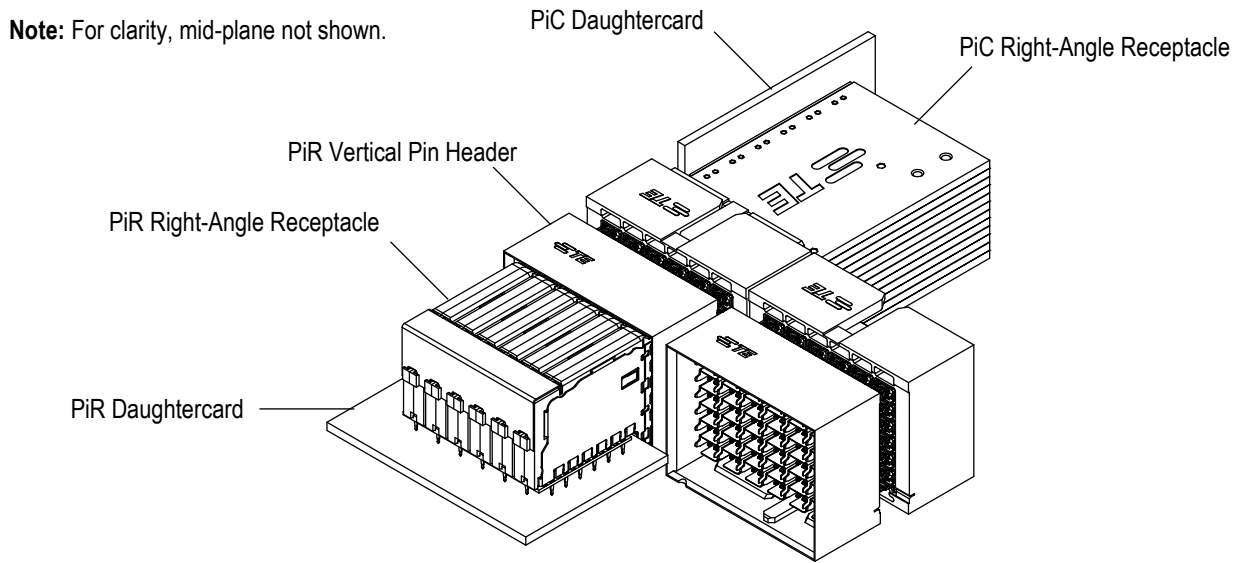

Figure 5 (End)

B. Universal Guides

1. Pick-up capability and placement of these guides with the connectors on the pc board is shown in Figure 6. When selecting a guide pin & module, consideration must be given to the size & weight of the plug-in module. Both die cast and machined stainless steel guide pins are available. A comparison of the guide pin strength is shown at the bottom of Figure 6.

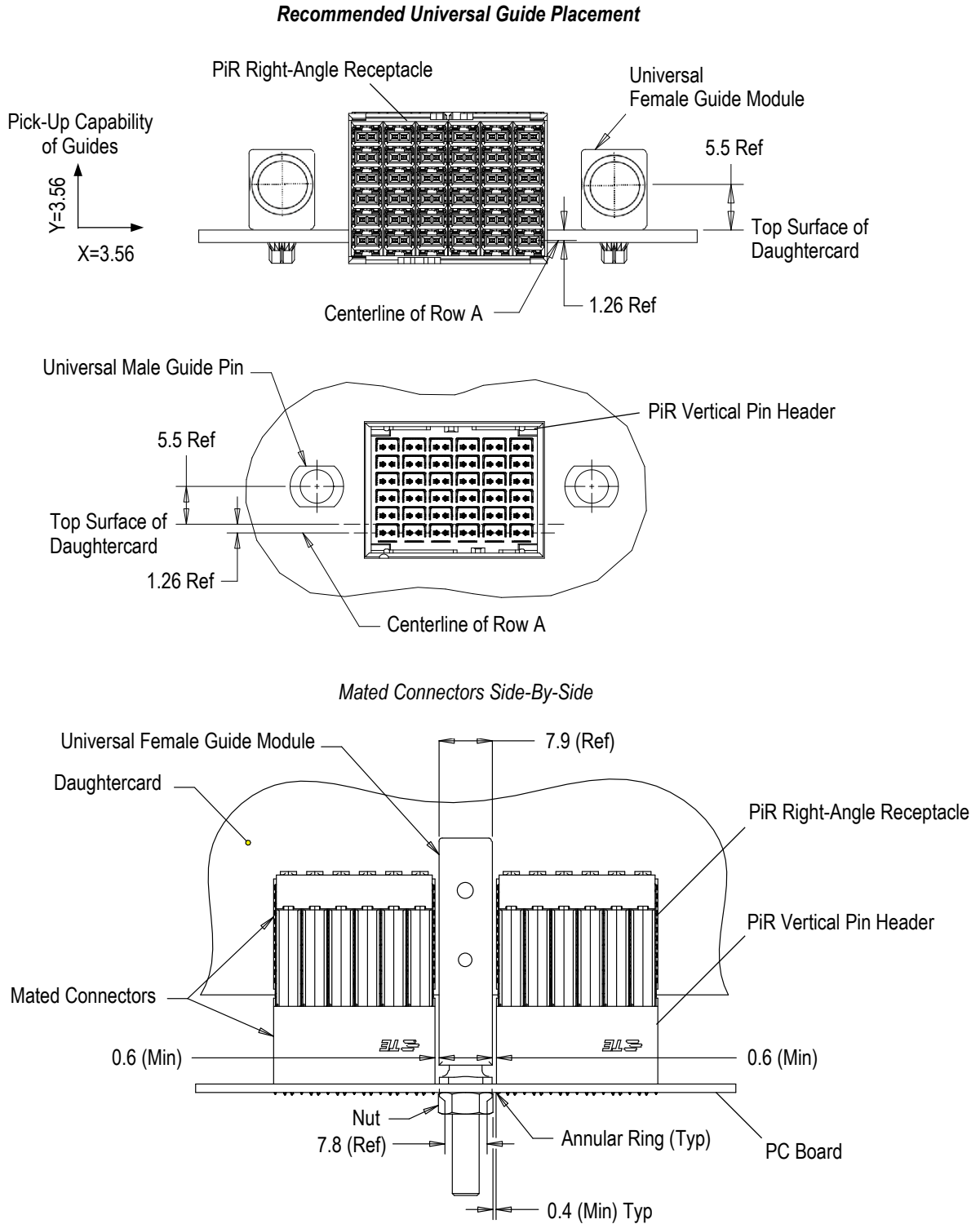
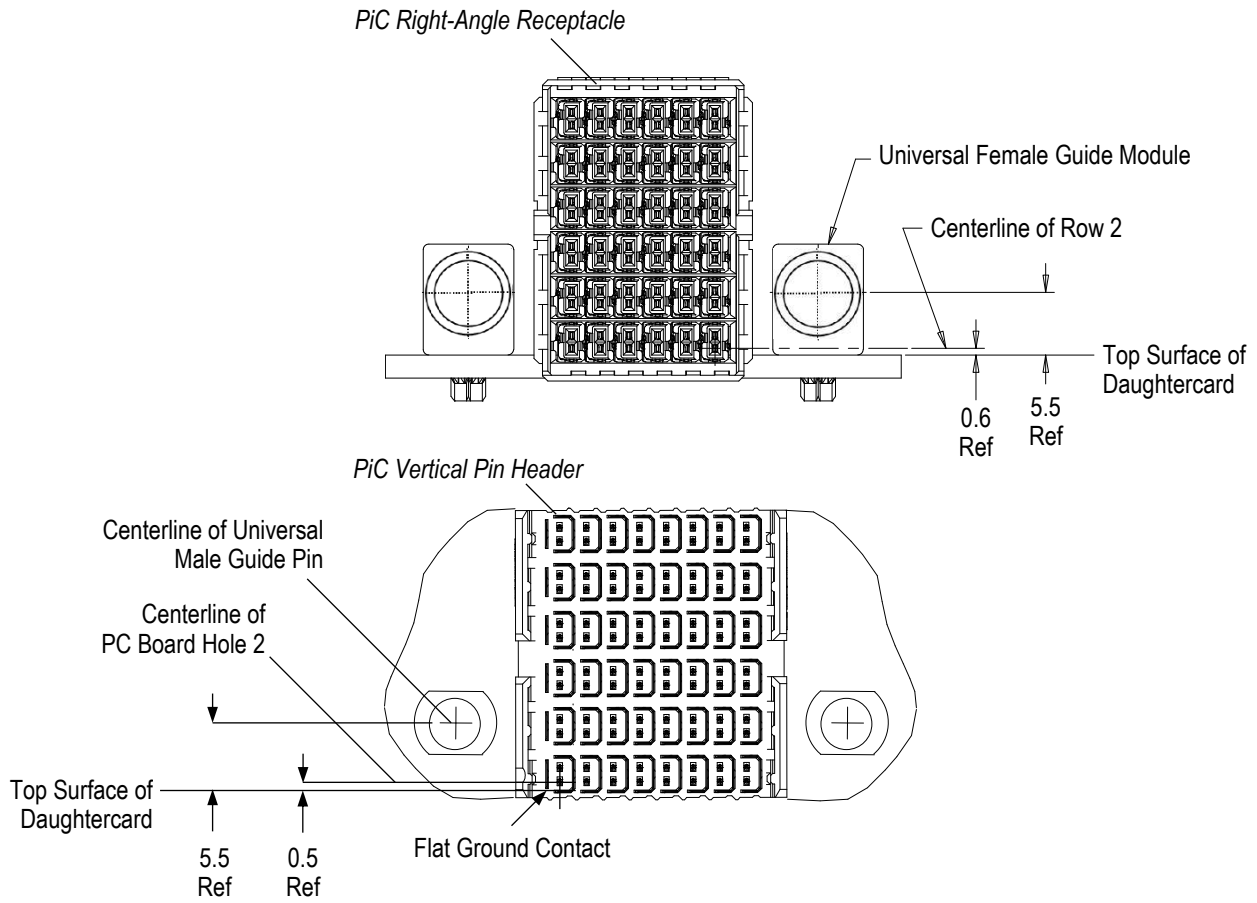

Figure 6 (Cont'd)

Recommended Universal Guide Placement



Mated Connectors Side-By-Side

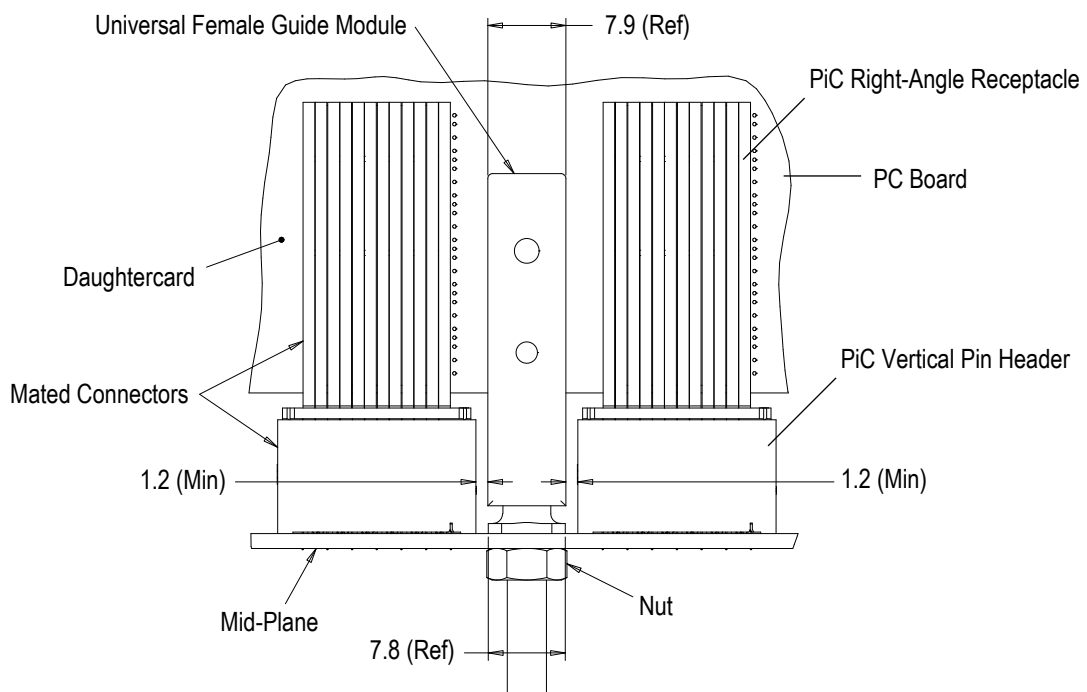
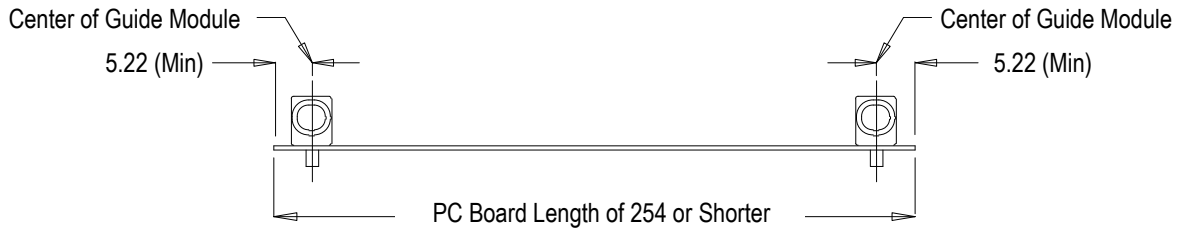

Figure 6 (Cont'd)

Placement of 2 Universal Female Guide Modules



Note: For pc boards longer than 254, call the number at the bottom of page 1.

Placement of 3 Universal Female Guide Modules

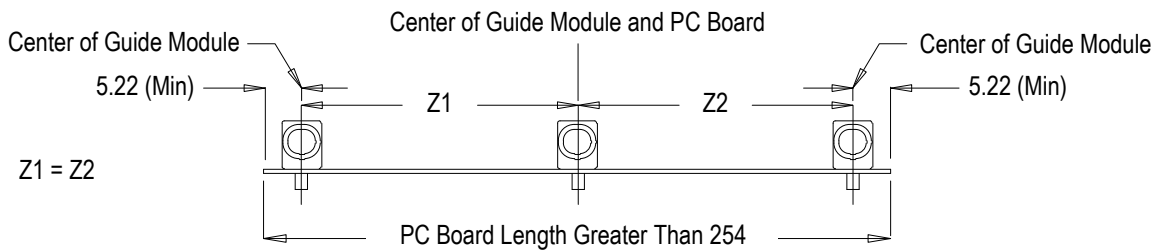

Guide Pin Force-Deflection

Pin	Spring Rate	Deflection at 8 lbf	Deflection at 13 lbf
Machined Pin (Flange Vertical)	~31,500 gf/mm	0.12mm	0.19mm
Machined Pin (Flange Horizontal)	~29,530 gf/mm	0.12mm	0.20mm
Die Cast Pin (Flange Horizontal Key Right)	~11,810 gf/mm	0.31mm	0.50mm
Die Cast Pin (Flange Vertical Key Top)	~18,110 gf/mm	0.20mm	0.33mm
Die Cast Pin (Flange Vertical Key Bottom)	~8,660 gf/mm	0.41mm	0.67mm

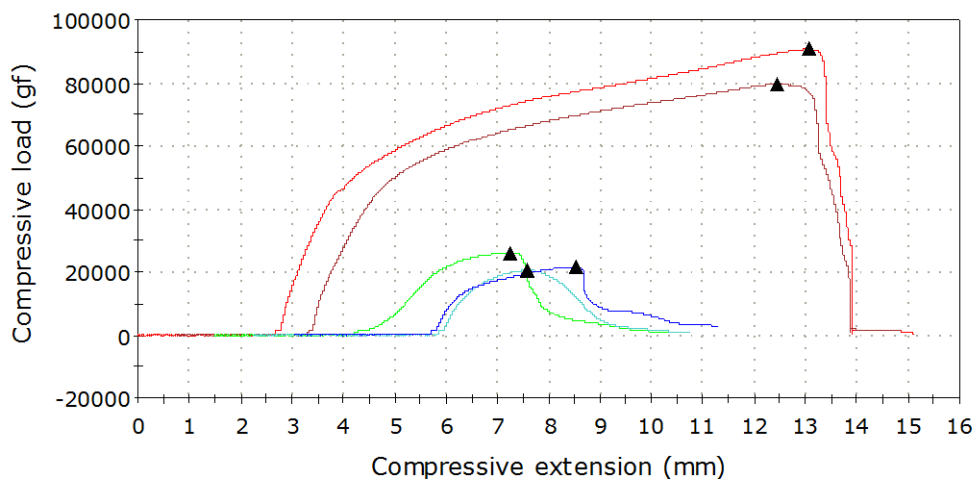

Figure 6 (End)

3.6. Universal Guide Installation

Insertion of Universal guides into the pc boards must be applied with tooling capable of applying a downward force between 222 and 1112 N [50 and 250 lb-force.]. For pc boards having a thickness under 4.45, a pc board support must be used (refer to Section 5 for design details).

These guides must be fully seated on the pc board. The female guide module screw (M3×0.5) and male guide pin screw and each must be tightened to a maximum torque of 1.01 Nm [9 in.-lbs].



CAUTION

To avoid damage of the guide pin do not apply force directly to the tip.

Typical application of these guides is shown in Figure 7.

Typical Application of Universal Guides

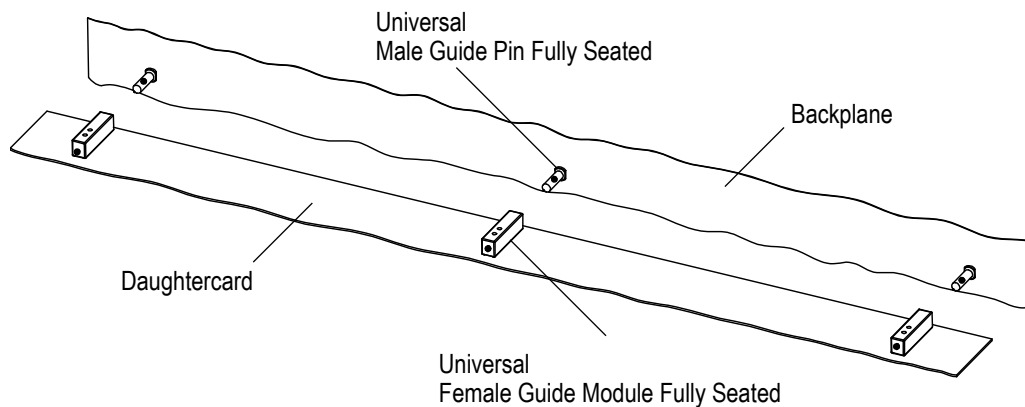

Note: PC board holes for connectors not shown.

Figure 7

3.7. Connector Installation

A. Initial Positioning

These connectors are typically applied to the pc board manually using nitrile gloves or using an automatic machine. Connectors should be gripped by the housing and/or chicklets only and not by the contacts.

When placing the connector onto the pc board, all contact leads should be aligned and inserted into the pc board simultaneously to prevent twisting or bending of the contacts. In addition, when manually placing the receptacle on the pc board, the row of contact leads closest to the pc board edge should be aligned first, then the remainder of the rows should be aligned by rolling the receptacle from front to back.

These connectors must be placed on the pc board so that pin 1 to position 1 orientation is maintained. After the connector is placed on the pc board, the open portion of all contacts must be inside the pc board hole as shown in Figure 8.



NOTE

These connectors must be placed on the pc board so that pin 1 to position 1 orientation is maintained. See Figure 8.

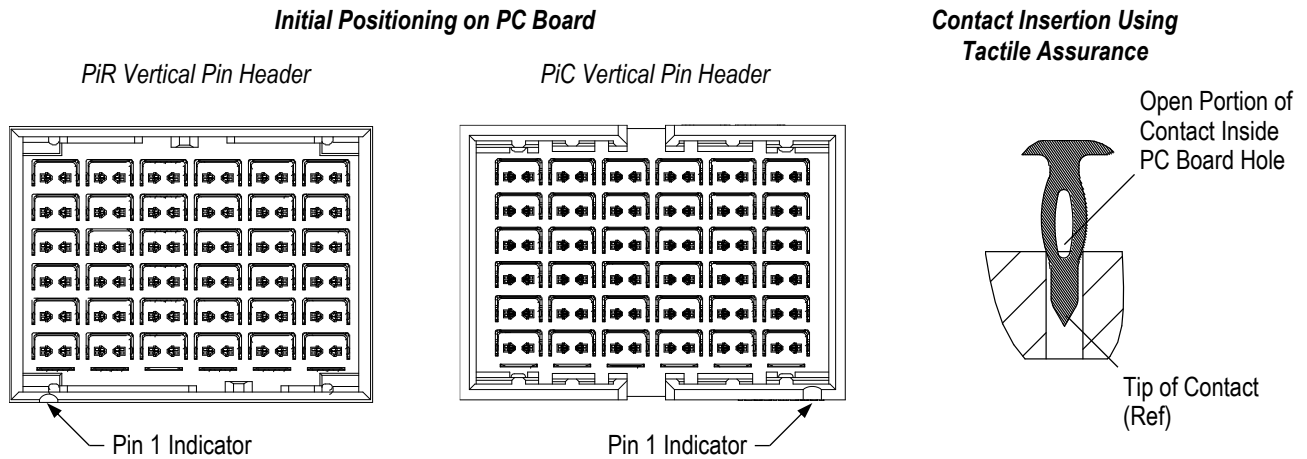

Figure 8

B. Seating

Seating force must be applied evenly on the connectors to prevent deformation or other damage to the contacts and housings. When installing the pin header, the insertion force must be evenly applied to the assembly using the appropriate seating tool. When installing the receptacle, the insertion force must be evenly applied to the assembly as shown in Figure 9.

Tooling used to seat these connectors must be capable of supplying a controllable downward force needed to seat the connector. Seating force will vary according to pc board variations and signal pin count. The average insertion force is around 8.7 N [1.96 lb-force] per compliant pin press-fit contact. The maximum insertion force is 17.8 N [4.0 lb-force] per compliant pin press-fit contact.



CAUTION

Correct seating of connector is essential to interconnection performance. This includes correct seating height (see Figure 9) and force applied. Over-seating of connectors will deform parts critical to the quality of the connector. Maximum force occurs prior to the connector bottoming on the pc board.

C. Seating Height

Pin headers and receptacles must be seated to the dimensions shown in Figure 9.

For mid-plane applications, a pc board support must be used for both connectors when seating the second connector. Refer to Figure 9.

Single Plane Application

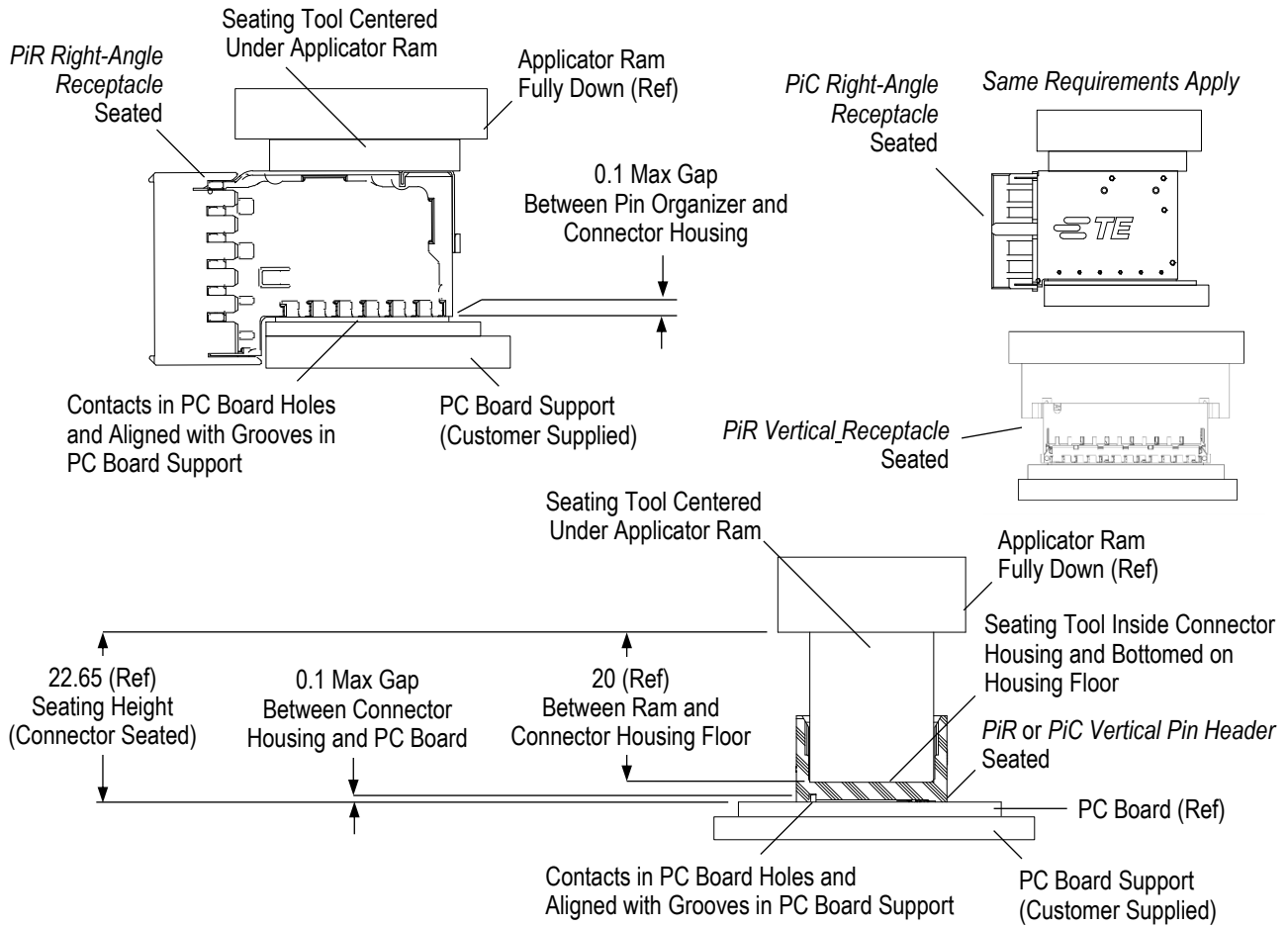

Mid-Plane Application

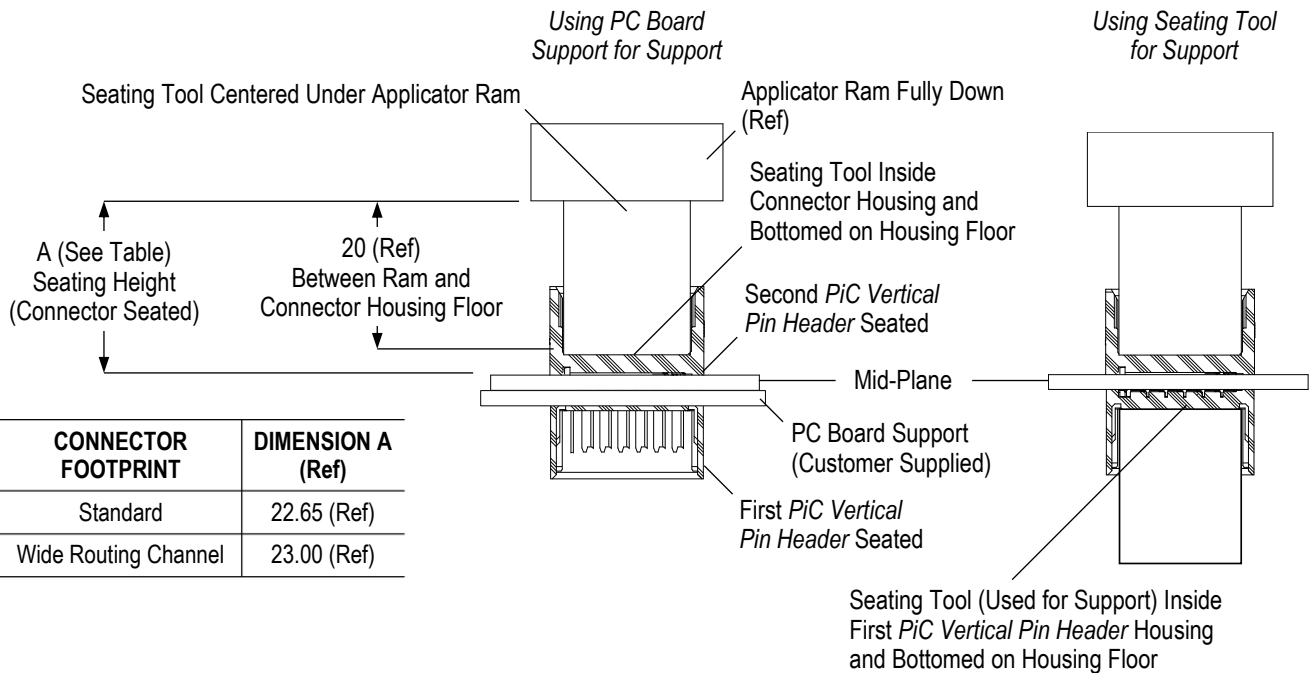

CONNECTOR FOOTPRINT	DIMENSION A (Ref)
Standard	22.65 (Ref)
Wide Routing Channel	23.00 (Ref)

Figure 9 (Cont'd)

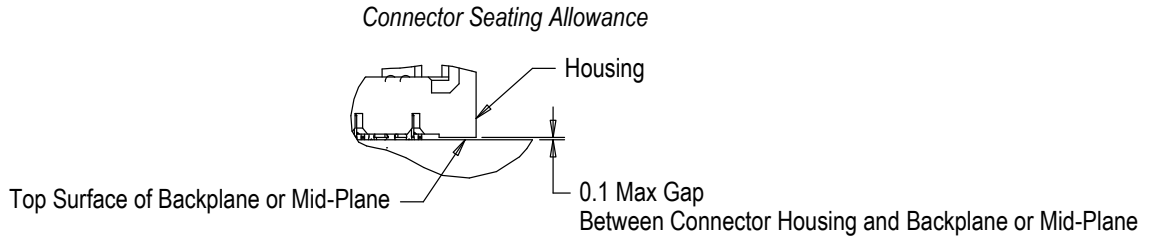

Figure 9 (End)

3.8. Mating

A. Alignment

Proper alignment is essential to ensure full engagement of mating connectors and to ensure that contacts are not bent or otherwise damaged during mating and unmating. For tolerance limitations, see Figure 10 (tolerances apply when connectors are free-floating and allowed to gather).

Note: 6-Pair 6-Column Vertical Pin Header and Right-Angle Receptacle Shown

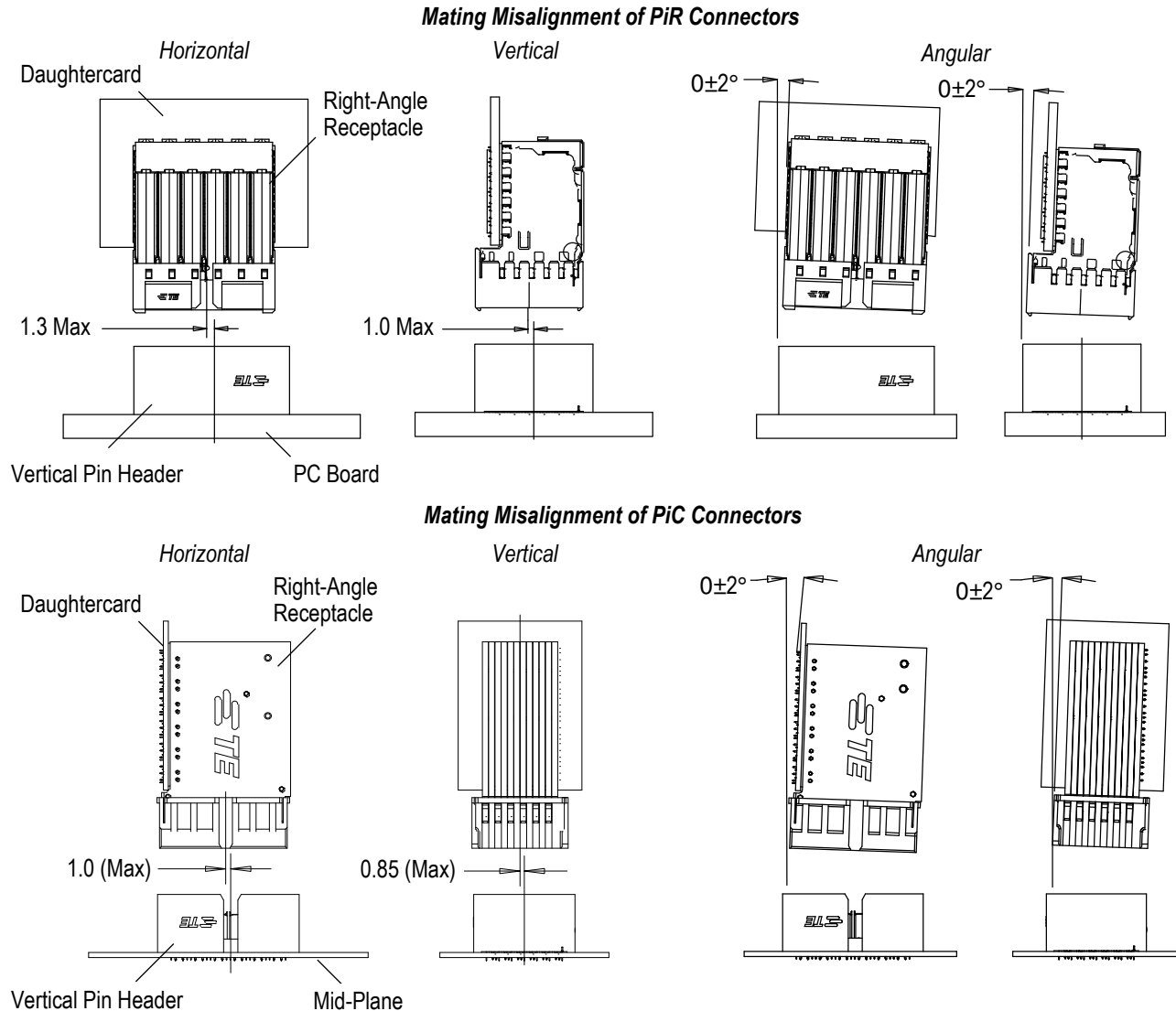

Figure 10

B. Sequences and Wipe Length

This connector system has two basic levels of sequencing during mating. The order of mating is: ground shield and signal pin. The relative distances between sequencing events as a function of the distance between the surface of the backplane and the centerline of the daughtercard connector ref A2 pin is given in Figure 11.

CONNECTOR				DIMENSION X					FULLY MATED WIPE LENGTH		
UNIT	CONTACT ARRANGEMENT	FOOTPRINT	CONTACT TYPE	FULLY MATED	RELIABLE MATE		FIRST MATE, LAST BREAK		360	Main	
					360	Main	360	Main			
85-Ohm 92-Ohm	PiC	Wide Routing Channel	Signal	17.10	—	19.62	—	20.03	—	2.52	
			Ground		19.16	20.59	19.65	21.05	2.06	3.49	
		Standard	Signal	16.75	—	19.27	—	19.68	—	2.52	
			Ground		19.31	20.24	19.80	20.65	2.56	3.49	
	PiR	STRADA Whisper	Signal	14.75	—	17.25	—	17.65	—	2.50	
			Ground			17.99		18.40		3.24	
		STRADA Whisper R	Signal	14.50	(A1 GND Pin)	—	17.00	—	17.40	—	2.50
			Ground			17.74	18.15	3.24			
100-Ohm	PiR and PiC	All	Signal	14.75	—	17.25	—	17.65	—	2.50	
			Ground			17.99		18.40		3.24	
	PiR Vertical Receptacle	All	Signal	15.00	—	17.50	—	17.90	—	2.50	
			Ground			18.24		18.65		3.24	

Note: Dimensions are calculated using nominal connector conditions. Connectors are assumed to be seated flush with the pc board.

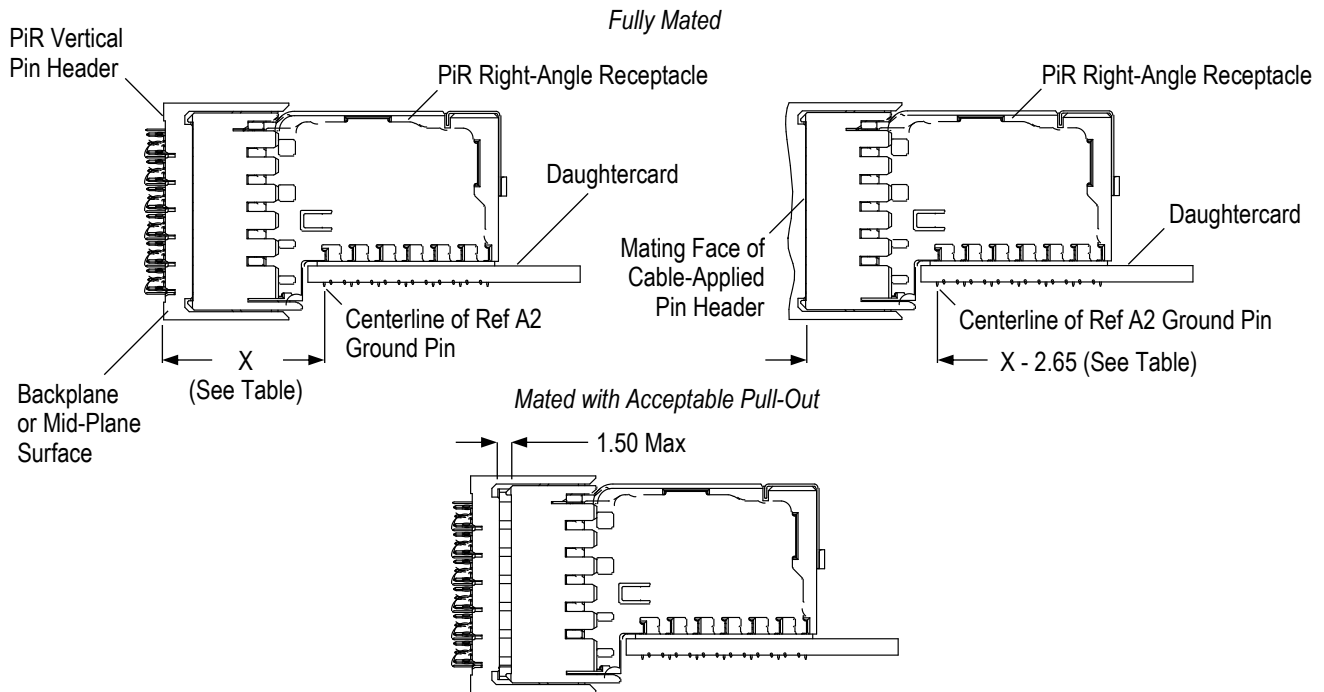

Note: The first mate, last break sequencing point is the first and last instance in a mating cycle where the pin makes contact with the beam, but has not deflected the beam. The reliable mating point is the first and last instance in a mating cycle where the pin has completely deflected the beam and the beam is supplying full normal force to the pin.

Figure 11

Full mating of connectors is necessary to ensure a good connection and to obtain the maximum signal transmission performance. The dimension shown for the fully mated condition from the surface of the backplane to the first row of contacts of the daughtercard connector is recommended; however, the maximum pull-out dimension given in Figure 12 is acceptable.

Connector wipe length is calculated by subtracting the fully mated condition from the reliable mating point data. Wipe lengths are given in Figure 12.

i NOTE
For circuit routing concerns or applications with sense pins, call the number at the bottom of page 1.

3.9. Removal

i NOTE
A pc board support must be used when removing connectors or any guides. Refer to Section 5 for design requirements.

A. Universal Female Guide Module

The female guide module can be removed from the pc board using tooling capable of applying downward pressure of 333 N [75 lb-force].

B. Universal Male Guide Pin

The male guide pin can be removed from the pc board using tooling capable of applying downward pressure of 556 N [125 lb-force].

For the external threaded male guide pin, the nut must be removed, then downward pressure can be applied to the threads to remove the male guide pin. For the internal threaded male guide pin, the screw must be removed, a 3.5 diameter pin can be inserted into the screw hole, then downward pressure can be applied to the pin to remove the male guide pin.

C. Connector

Connectors can be removed from the pc board and replaced. The entire connector must be removed from the pc board and replaced with a new one.



CAUTION

To avoid damage to the connectors, ammonia should not be used in the removal process.

3.10. Repair and Rework



NOTE

To ensure plated through-hole integrity, connectors should only be replaced no more than two times or a max of three insertions per pc board. Tools for removing connectors from pc boards are provided in section 5 tooling.

Damaged or defective connectors must not be used.

Even though this connector system uses press-in compliant pins and does not require solder, pc board repair or rework could require soldering after the connectors are inserted in the pc board; therefore, the following requirements apply:

- Ammonia must not be used for cleaning the assemblies. Material in STRADA Whisper connector signal contacts will have a reaction to ammonia.
- Air drying of cleaned connectors is recommended.
- If a cleaning agent is used, gold surfaces of contact tines must be re-lubricated with a Telcordia-approved lubricant.



CAUTION

Even when using "no clean" solder paste, it is imperative that the contact interface be kept clean of flux and residue, since it acts as an insulator.



DANGER

Consideration must be given to toxicity and other safety requirements recommended by the solvent manufacturer. Refer to the manufacturer's material safety data sheet (MSDS) for characteristics and handling of cleaners. Trichloroethylene and methylene chloride is not recommended because of harmful occupational and environmental effects.

4. QUALIFICATION

STRADA Whisper Connector Systems are Recognized by Underwriters Laboratories Inc. (UL) in File E28476, Vol.85, section 4.

5. TOOLING

Tooling part numbers and instructional material packaged with the tooling for these connectors are given in Figure 12.

5.1. PC Board Support

The pc board support must have minimum thickness of 1 and a flat surface with holes or a channel wide and deep enough to receive any protruding compliant pins and parts. The pc board support must be used:

- with pc boards having a thickness less than 2 to allow clearance for protruding contact tails
- during seating of a connector onto the pc board
- during removal of a STRADA Whisper connector guide from the pc board

5.2. Seating Tools and Removal Tools

The seating tool assembly for the pin header is designed to push on the housing and ground contacts to seat the pin header onto the pc board. A customer-designed flat rock must be used to seat the receptacle.

The removal tool assembly for the receptacle includes all of the tooling to remove a connector from the pc board. The tooling is designed to be used based on the connector size and position on the pc board.

5.3. Power Unit

The power unit is an automatic or semi-automatic machine used to supply the force to seat the connector onto the pc board using seating tools. The power unit must have a ram and be capable of supplying a downward force needed to seat the connector. Typical TE Connectivity power units include, but are not limited to, the power units given in Figure 12.

5.4. Drilling Holes in PC Board

Recommended drill bits for drilling contact holes in the pc board are available from:

CONTACT HOLE DIAMETER	COMPANY AND DRILL BIT PART NUMBER	
		Carbide Related Technologies (CRT) 355 Sackett Point Road, Unit 5 North Haven, CT 06473 USA Phone: 203-281-1266 www.carbiderelatedtech.com
0.32	DSP0126L05A	H0320-DUS40030
0.42	DSP0165L05A	H0420-DUS40055

i **NOTE** *Drill bits other than recommended may be used as long as the drill hole size tolerance prior to plating is achieved.*



Model BMEP 5T
Machine 1585696-1



Model MEP 6T
Machine 1585699-1

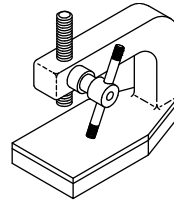

Manual Arbor Frame Assembly
(Commercially Available)

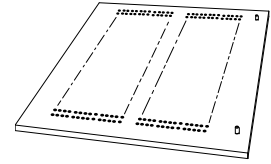

PC Board Support
(Customer Supplied)

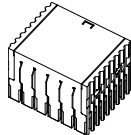

Seating Tool Assembly for Pin Header (Refer to Tables)

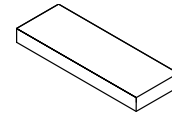

Flat Rock for Seating Right-Angle
Receptacle (Customer Designed)

PIR-85 Ohm and 100-Ohm PIN HEADER SIZE	SEATING TOOL ASSEMBLY
4x4	2185040-1
4x6	2215003-1
4x8	2215003-2
6x3	2215018-2
6x4	2185261-3
6x6	2215004-1
8x4	2215060-3
8x6	2215060-2
8x8	2215060-1
8x10	2215060-5
9x6	2185043-1
9x8	2215015-1
12x6	2018878-1
12x8	2215060-4

▪ With Male Guide Pin

PiC PIN HEADER		SEATING TOOL ASSEMBLY
UNIT	SIZE	
85-Ohm	4x6	2215019-[]
	6x6	2215004-[]
100-Ohm	6x7	2215006-[]
	6x8	2215011-[]
	6x11	2215008-[]
	6x12	2018878-[]

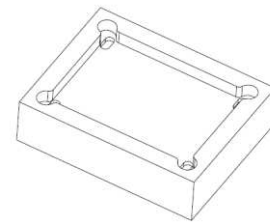

Seating Tool for Vertical Receptacle
(TE p/n 2295101-1, Customer Manufactured)

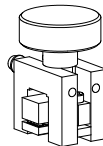

Removal Tool Kits for
Pin Header (Refer to Table)
(408-32059)

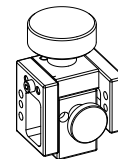

Removal Tool Kits for
Receptacle (Refer to Table)
(408-32054)

CONNECTOR SIZE	REMOVAL TOOL KIT	
	PIN HEADER	RECEPTACLE
4x6	2161742-1	2161745-1
6x6	2161744-1	2161752-1
8x6	2161756-1	2161754-1

Figure 12

6. VISUAL AID

The illustration below shows a typical application of 3.9-mm pitch 85-ohm, 92-Ohm and 100-ohm STRADA Whisper connector system. This illustration should be used by production personnel to ensure a correctly applied product. Applications which do not appear correct should be inspected using the information in the preceding pages of this specification and in the instructional material shipped with the product or tooling.

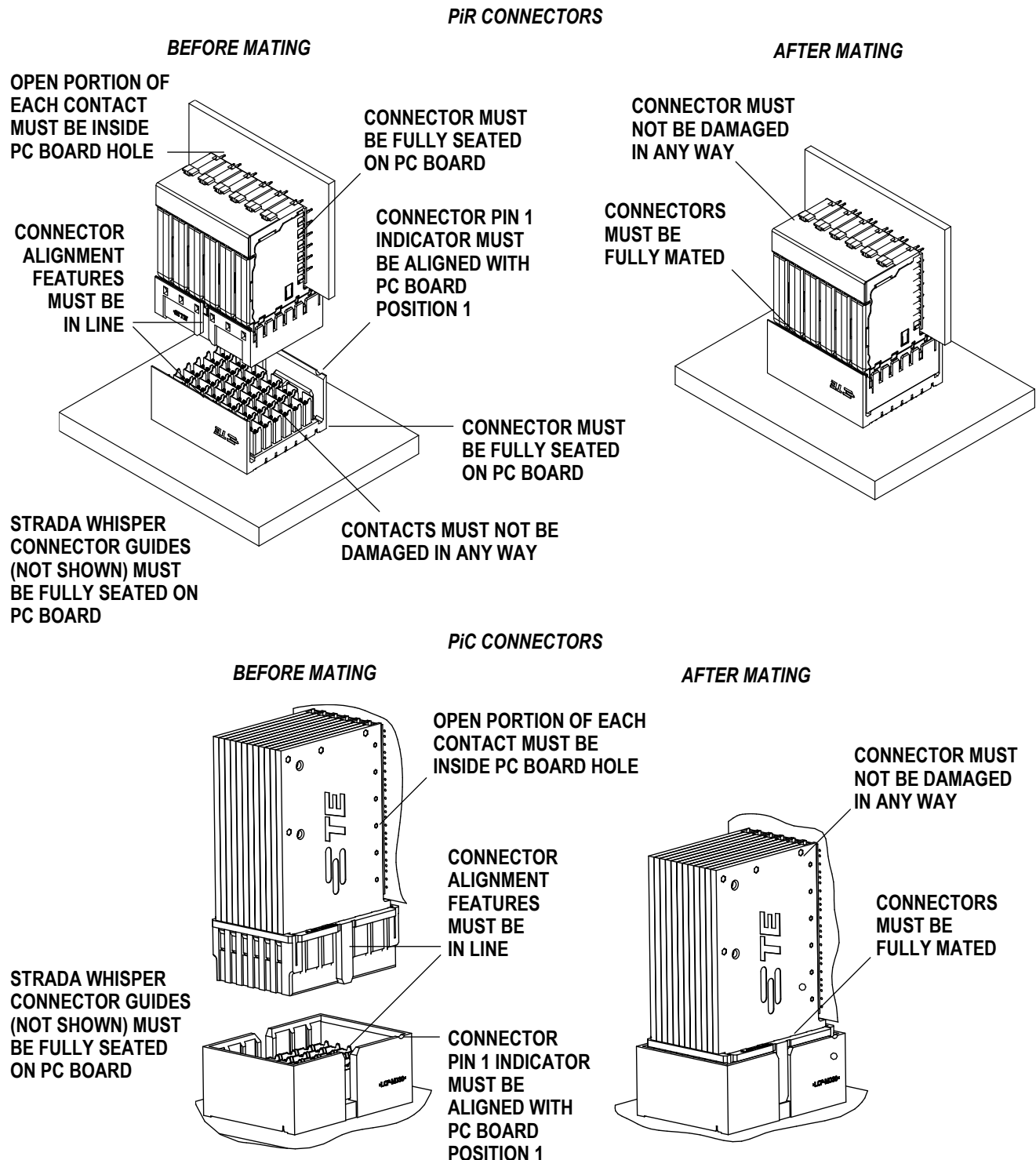

FIGURE 13. VISUAL AID