

Low Profile, Configurable Power Solution

Features & Benefits

- DC input: 28V_{DC}
- Output voltages:
 - 3.3 – 48V_{DC}
 - 40 – 400W total
 - 1, 2, or 3 outputs
- Protective features:
 - Inrush current limiting
 - Input transient protection:
 - per MIL-STD-704E/F (M-FIAM5B)
 - per MIL-STD-704A/E/F & MIL-STD-1275A/B/D (M-FIAM9)
 - EMI filtering per MIL-STD-461E
- Local or remote control
- Compliant to MIL-STD-810F for vibration (Method 514.5, Procedure I) and shock (Method 516.5, Procedure I) Module environmental stress screening
- Package style:
 - Low profile mounting options
 - Optional finned heat sink

Product Highlights

The 28V_{DC} MIL-COTS VIPAC family of power systems is a new class of user-defined, modular power solutions for the most demanding military applications. It incorporates preassembled and tested front ends (M-FIAM5B or M-FIAM9), Vicor Maxi, Mini and Micro series DC-DC converters (H or M-Grade), a choice of output connections and mechanical platforms. The 28V_{DC} VIPAC can be specified with 1, 2 or 3 outputs with voltages as low as 3.3V_{DC} to as high as 48V_{DC} and power levels from 40 to 400W per output. Additionally, the wide trim range of the modules can provide operating voltages from 500mv to 52.8V. The MIL VIPAC is available with an input of 28V_{DC} in a variety of packages with profiles as low as 0.75".

For additional technical or design information; or to create a 28V_{DC} VIPAC tailored to your specific requirements using Vicor's online configurator, please visit vicorpower.com.



Configurations

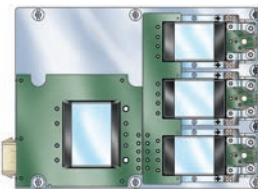

3 Micros (MVC-Axxx, MVX-Axxx)

- 4.96" x 6.8" (126,0 x 172,7mm)
- 1.4 lbs (640g)
- Dual or triple output
- Up to 300W

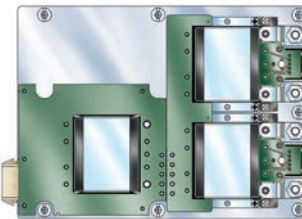

2 Minis (MVC-Bxxx, MVX-Bxxx)

- 4.96" x 6.8" (126,0 x 172,7mm)
- 1.4 lbs (640g)
- Single or dual output
- Up to 400W

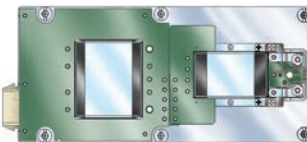

1 Micro (MVC-Gxxx, MVX-Gxxx)

- 3.15" x 6.8" (80,0 x 172,7mm)
- 0.9 lbs (411g)
- Single output
- Up to 100W

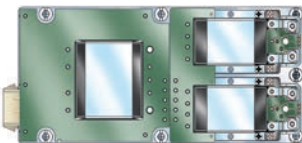

2 Micros (MVC-Dxxx, MVX-Dxxx)

- 3.15" x 6.8" (80,0 x 172,7mm)
- 1.0 lbs (457g)
- Single or dual output
- Up to 200W

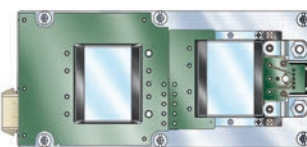

1 Mini (MVC-Exxx, MVX-Exxx)

- 3.15" x 6.8" (80,0 x 172,7mm)
- 1.0 lbs (457g)
- Single output
- Up to 200W

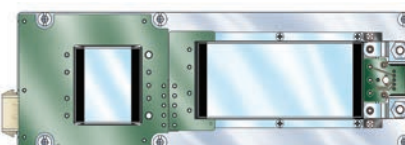

1 Maxi (MVC-Fxxx, MVX-Fxxx)

- 3.15" x 9.15" (80,0 x 234,4mm)
- 1.3 lbs (594g)
- Single output
- Up to 400W

Note: Weights are for coldplate versions • MVC-xxx refers to M-FIAM5B • MVX-xxx refers to M-FIAM9

MIL VIPAC General Specifications

Typical at 25 °C, nominal line and load, unless otherwise specified.

INPUT SPECIFICATIONS

Parameter	Min	Typ	Max	Unit	Notes
Input voltage	18	28	36	V _{DC}	Continuous
Inrush limiting			0.007	A/μF	
Transient immunity (M-FIAM5B)			50	V _{DC}	12.5ms per MIL-STD-704E/F, continuous operation Test conditions AA and FF normal overvoltage transients per MIL-HDBK-704
Transient immunity (M-FIAM9)			100	V _{DC}	50ms per MIL-STD-1275A/B/D, continuous operation
			250	V _{DC}	70μs per MIL-STD-1275A/B/D, continuous operation
			70	V _{DC}	20ms per MIL-STD-704A, continuous operation
			50	V _{DC}	12.5ms per MIL-STD-704E/F, continuous operation
EMI		MIL-STD-461E			
Conducted emissions		CE101,CE102*			
Conducted susceptibility		CS101, CS114, CS115, CS116			

*CE102 compliant with loads in excess of 30% of rated output; loads below 30% may need additional input capacitance for compliance.

ENVIRONMENTAL - SYSTEM

Parameter	Min	Typ	Max	Unit	Notes
Dielectric withstand, input to chassis	1500/2121			V _{RMS} /V _{DC}	
Operating chassis temperature					
H-Grade	-40		95	°C	
M-Grade	-55		95	°C	
Storage temperature					
H-Grade	-55		125	°C	
M-Grade	-65		125	°C	
Shock					
MIL-STD-810F, Method 516.5, Procedure I					40g for 15-23ms, 75g for 8-13ms
Vibration					
MIL-STD-810F, Method 514.5, Procedure I					20-2000Hz at 5g

OUTPUT SPECIFICATIONS

Parameter	Min	Typ	Max	Unit	Notes
Output voltage setpoint			±1	%	V _{OUT} nom
Line regulation		±0.02	±0.2	%	Low line to high line; full load
Temperature regulation		±0.002	±0.005	%/°C	Over operating temperature range
Over temperature shutdown		115		°C	
Power sharing accuracy		±2	±5	%	
Programming range	10		110	%	Of nominal voltage. (For trimming below 90% of nominal, a minimum load of 10% rated power may be required)
Current limit		115		% I _{OUT} max	Output voltage 95% of nominal
Short circuit current		115		% I _{OUT} max	Output voltage <250mV

MIL VIPAC SPECIFIC Specifications

ENVIRONMENTAL - MODULES

Altitude MIL-STD-810C, Method 500.2, Procedure I & II, 40,000 ft. and 70,000 ft. Operational.
Explosive Atmosphere MIL-STD-810F, Method 511.4, Procedure I, Operational.
Vibration MIL-STD-810F, Method 514.5, Procedure I, Category 14, Sine and Random vibration per Table 514.5C for Helicopter AH-6J Main Rotor with overall level of 5.6 Grms for 4 hours per axis. MIL-STD-810F, Method 514.5C, General Minimum Integrity Curve per Figure 514.5C-17 with overall level of 7.7 Grms for 1 hour per axis.
Shock MIL-STD-810-F, Method 516.5, Procedure I, Functional Shock, 40 G's. MIL-S-901D, Lightweight Hammer Shock, 3 impacts/axis, 1,3,5 ft. MIL-STD-202F, Method 213B, 60 G's, 9ms half sine. MIL-STD-202F, Method 213B, 75 G's, 11ms Saw Tooth Shock.
Acceleration MIL-STD-810F, Method 513.5, Procedure II, Table 513.5-II, Operational, 2-7 G's, 6 directions.
Humidity MIL-STD-810F, Method 507.4, Procedure I, Cycle I, 240 hrs, 95% RH.
Solder Test MIL-STD-202F, Method 208, 8 hour aging.

MIL-COTS 28V_{DC} VIPAC OUTPUT POWER OPTIONS (OUTPUT POWER BASED ON 28V_{DC} NOMINAL INPUT VOLTAGE)

VIPAC Configuration	No. of Outputs	Power (W)							
		3.3 V	5 V	12 V	15 V	24 V	28 V	48 V	48 V
Total²									
Single micro ¹	Single	75	100	100	100	100	100	100	100
Dual micro ¹	Single //	150	200	200	200	200	200	200	200
	Dual	75	100	100	100	100	100	100	200
Triple micro ¹	Dual	150	200	200	200	200	200	200	300
		75	100	100	100	100	100	100	
	Triple	75	100	100	100	100	100	100	300
		75	100	100	100	100	100	100	
Single mini ¹	Single	150	200	200	200	200	200	200	200
Dual mini ¹	Single //	300	400	400	400	400	400	400	400
	Dual	150	200	200	200	200	200	200	400
		150	200	200	200	200	200	200	
Maxi ¹	Single	264	400	400	400	400	400	400	400

// = parallel

¹ Lower power modules available – consult website for more information.

² Derate output power per chart below.

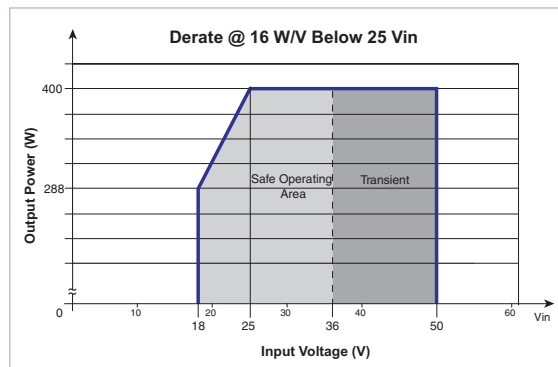

28V MIL-COTS VIPAC Derating Curve

MIL VIPAC Specific Specifications (Cont.)

MICRO MODULES

Parameter	3.3V	5V	12V	15V	24V	28V	48V	Unit	Notes
Efficiency (typ)	79	84	85.8	89	88	89	87.7	%	
Ripple & noise, p-p (typ)	140	100	209	100	70	85	100	mV	20MHz bandwidth
Output power	75	100	100	100	100	100	100	Watts	95°C Chassis
Output OVP setpoint	4.3	6.25	14.3	17.8	28.1	32.7	55.7	Volts	Recycle input volt. to restart (1m off)
Dissipation, standby (typ)	4	3.2	4.4	4.6	3.6	3.3	3	Watts	No load
Load reg. (max)	0.02	0.02	0.02	0.02	0.02	0.02	0.02	±%V _{out}	No load to full load

Note: 50W Micro models are now available.

MINI MODULES

Parameter	3.3V	5V	12V	15V	24V	28V	48V	Unit	Notes
Efficiency (typ)	79	82.5	86	86.6	87	87	87.5	%	
Ripple & noise, p-p (typ)	100	95	360	250	260	180	225	mV	20MHz bandwidth
Output power	150	200	200	200	200	200	200	Watts	95°C Chassis
Output OVP setpoint	4.3	6.3	14.4	17.8	28.5	32.8	55.8	Volts	Recycle input volt. to restart (1m off)
Dissipation, standby (typ)	5	5.1	4.6	3.4	5.1	4.5	5.4	Watts	No load
Load reg. (max)	0.02	0.02	0.02	0.02	0.02	0.02	0.02	±%V _{OUT}	No load to full load

MAXI MODULES

Parameter	3.3V	5V	12V	15V	24V	28V	48V	Unit	Notes
Efficiency (typ)	78.5	82	86.8	87.5	88.5	87.8	86.7	%	
Ripple & noise, p-p (typ)	75	152	70	60	80	172	58	mV	20MHz bandwidth
Output power	264	400	400	400	400	400	400	Watts	95°C Chassis
Output OVP setpoint	4.3	6.25	14.3	17.8	28.1	32.7	55.8	Volts	Recycle input volt. to restart (1m off)
Dissipation, standby (typ)	8	6.8	6.8	6.3	11	6.3	11.8	Watts	No load
Load reg. (max)	0.02	0.02	0.02	0.02	0.02	0.02	0.02	±%V _{OUT}	No load to full load

Note: 300W (200W @ 3.3V) Maxi models are also available.

MECHANICAL DRAWINGS

**Configuration MVC-A / MVX-A
LugMates**

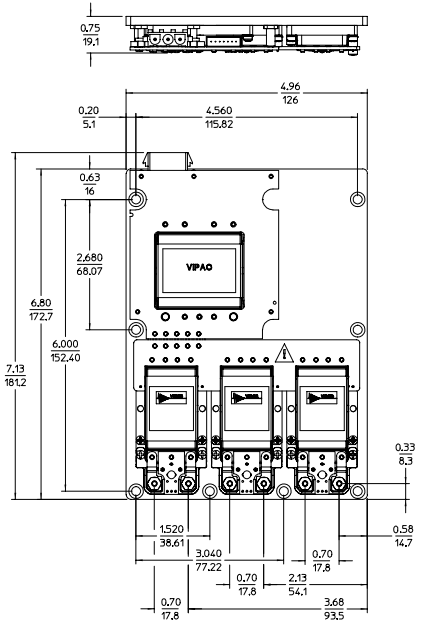

**Configuration MVC-B / MVX-B
LugMates**

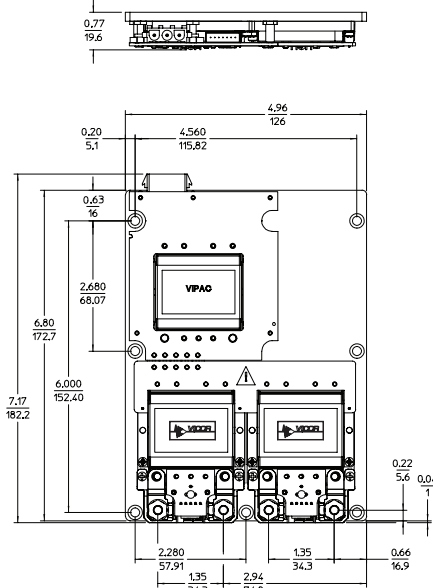

**Configuration MVC-D / MVX-D
LugMates**

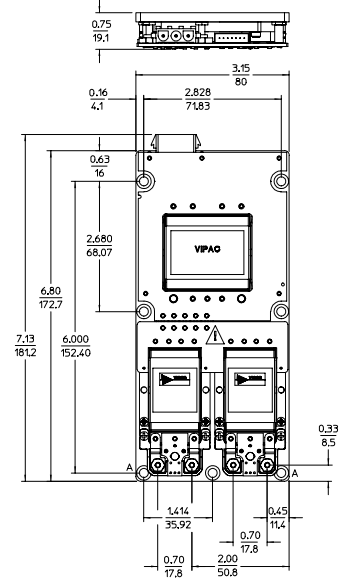

**Configuration MVC-E / MVX-E
LugMates**

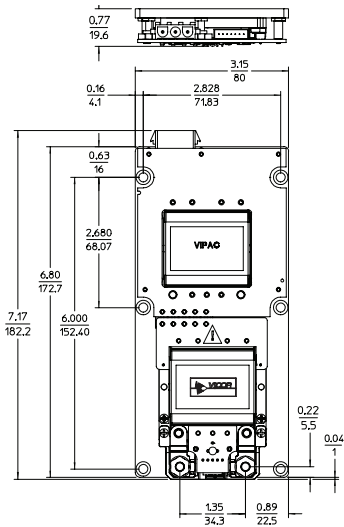

**Configuration MVC-F / MVX-F
LugMates**

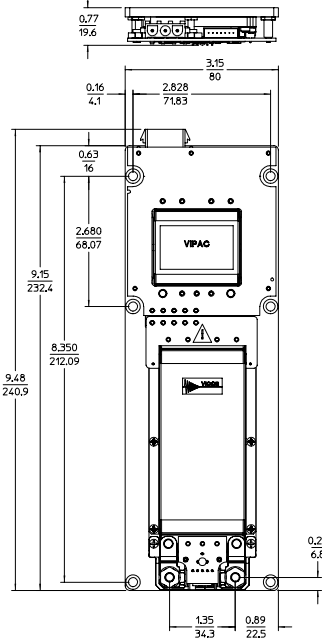

**Configuration MVC-G / MVX-G
LugMates**

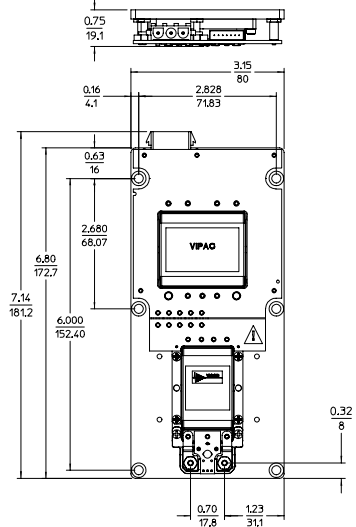

HEAT SINK OPTIONS

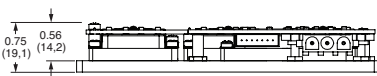

Coldplate

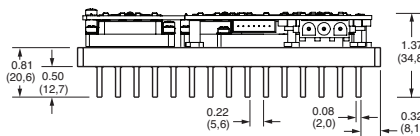

0.5" Fin Option

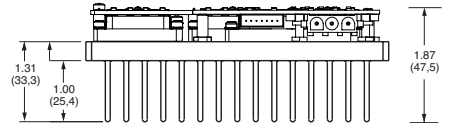

1" Fin Option
Fin spacing and relief are the same for both Fin options

Vicor's comprehensive line of power solutions includes high density AC-DC and DC-DC modules and accessory components, fully configurable AC-DC and DC-DC power supplies, and complete custom power systems.

Information furnished by Vicor is believed to be accurate and reliable. However, no responsibility is assumed by Vicor for its use. Vicor makes no representations or warranties with respect to the accuracy or completeness of the contents of this publication. Vicor reserves the right to make changes to any products, specifications, and product descriptions at any time without notice. Information published by Vicor has been checked and is believed to be accurate at the time it was printed; however, Vicor assumes no responsibility for inaccuracies. Testing and other quality controls are used to the extent Vicor deems necessary to support Vicor's product warranty. Except where mandated by government requirements, testing of all parameters of each product is not necessarily performed.

Specifications are subject to change without notice.

Vicor's Standard Terms and Conditions

All sales are subject to Vicor's Standard Terms and Conditions of Sale, which are available on Vicor's webpage or upon request.

Product Warranty

In Vicor's standard terms and conditions of sale, Vicor warrants that its products are free from non-conformity to its Standard Specifications (the "Express Limited Warranty"). This warranty is extended only to the original Buyer for the period expiring two (2) years after the date of shipment and is not transferable.

UNLESS OTHERWISE EXPRESSLY STATED IN A WRITTEN SALES AGREEMENT SIGNED BY A DULY AUTHORIZED VICOR SIGNATORY, VICOR DISCLAIMS ALL REPRESENTATIONS, LIABILITIES, AND WARRANTIES OF ANY KIND (WHETHER ARISING BY IMPLICATION OR BY OPERATION OF LAW) WITH RESPECT TO THE PRODUCTS, INCLUDING, WITHOUT LIMITATION, ANY WARRANTIES OR REPRESENTATIONS AS TO MERCHANTABILITY, FITNESS FOR PARTICULAR PURPOSE, INFRINGEMENT OF ANY PATENT, COPYRIGHT, OR OTHER INTELLECTUAL PROPERTY RIGHT, OR ANY OTHER MATTER.

This warranty does not extend to products subjected to misuse, accident, or improper application, maintenance, or storage. Vicor shall not be liable for collateral or consequential damage. Vicor disclaims any and all liability arising out of the application or use of any product or circuit and assumes no liability for applications assistance or buyer product design. Buyers are responsible for their products and applications using Vicor products and components. Prior to using or distributing any products that include Vicor components, buyers should provide adequate design, testing and operating safeguards.

Vicor will repair or replace defective products in accordance with its own best judgment. For service under this warranty, the buyer must contact Vicor to obtain a Return Material Authorization (RMA) number and shipping instructions. Products returned without prior authorization will be returned to the buyer. The buyer will pay all charges incurred in returning the product to the factory. Vicor will pay all reshipment charges if the product was defective within the terms of this warranty.

Life Support Policy

VICOR'S PRODUCTS ARE NOT AUTHORIZED FOR USE AS CRITICAL COMPONENTS IN LIFE SUPPORT DEVICES OR SYSTEMS WITHOUT THE EXPRESS PRIOR WRITTEN APPROVAL OF THE CHIEF EXECUTIVE OFFICER AND GENERAL COUNSEL OF VICOR CORPORATION. As used herein, life support devices or systems are devices which (a) are intended for surgical implant into the body, or (b) support or sustain life and whose failure to perform when properly used in accordance with instructions for use provided in the labeling can be reasonably expected to result in a significant injury to the user. A critical component is any component in a life support device or system whose failure to perform can be reasonably expected to cause the failure of the life support device or system or to affect its safety or effectiveness. Per Vicor Terms and Conditions of Sale, the user of Vicor products and components in life support applications assumes all risks of such use and indemnifies Vicor against all liability and damages.

Intellectual Property Notice

Vicor and its subsidiaries own Intellectual Property (including issued U.S. and Foreign Patents and pending patent applications) relating to the products described in this data sheet. No license, whether express, implied, or arising by estoppel or otherwise, to any intellectual property rights is granted by this document. Interested parties should contact Vicor's Intellectual Property Department.

Vicor Corporation

25 Frontage Road
Andover, MA, USA 01810
Tel: 800-735-6200
Fax: 978-475-6715

email

Customer Service: custserv@vicorpower.com
Technical Support: apps@vicorpower.com

Mouser Electronics

Authorized Distributor

Click to View Pricing, Inventory, Delivery & Lifecycle Information:

Vicor:

[MVC-D3029414](#) [MVX-G2771015](#) [MVC-B1914991](#) [MVX-D2965017](#) [MVC-D2551236](#) [MVC-D2226423](#) [MVC-F2922228](#) [MVC-A2830214](#) [MVX-D2598839](#) [MVC-F1529976](#) [MVX-D2635228](#) [MVC-B2458378](#) [MVC-F3008610](#) [MVC-A2884234](#) [MVX-B2987010](#) [MVC-F2198470](#) [MVC-A2570273](#) [MVX-F3133424](#) [MVC-E2024019](#) [MVC-E2486317](#) [MVC-B1933200](#) [MVC-F1807992](#) [MVX-F2767019](#) [MVC-G1764382](#) [MVX-E3192010](#) [MVX-B2442430](#) [MVX-D2968430](#) [MVC-F1566374](#) [MVC-F2267618](#) [MVC-D2286229](#) [MVX-D3178639](#) [MVC-E1771624](#) [MVX-E2463485](#) [MVC-A2845536](#) [MVX-G2224051](#) [MVX-E2497041](#) [MVC-D1935983](#) [MVC-B3072628](#) [MVX-B2247044](#) [MVC-D2004805](#) [MVX-E2593827](#) [MVC-D3212627](#) [MVC-E2656222](#) [MVX-F2762229](#) [MVX-F2304653](#) [MVC-D2551826](#) [MVC-D2539431](#) [MVX-A2762412](#) [MVX-D2849222](#) [MVC-E2494619](#) [MVC-A2111095](#) [MVX-E2487021](#) [MVX-F2429445](#) [MVX-E2820823](#) [MVX-D2208038](#) [MVC-G2620443](#) [MVC-D2811420](#) [MVC-A2805053](#) [MVC-E2493473](#) [MVC-D2228015](#) [MVC-A2029381](#) [MVC-G1954787](#) [MVX-A2473018](#) [MVC-B2554023](#) [MVC-D1738993](#) [MVX-D2192644](#) [MVX-D2443011](#) [MVC-B2699818](#) [MVX-G2813049](#) [MVX-E2487042](#) [MVX-E2121838](#) [MVC-B2209325E](#) [MVX-G2367241](#) [MVX-D2507031](#) [MVC-D2620428](#) [MVX-D2952217](#) [MVX-E2666822](#) [MVX-A2370091](#) [MVC-D1666184](#) [MVC-D2684413](#) [MVC-D1688583](#) [MVC-B1765785](#) [MVX-D2731433](#) [MVX-A2827662](#) [MVC-E1667583](#) [MVX-G2301252](#) [MVC-G1948617](#) [MVC-G2939817](#) [MVC-B2658420](#) [MVX-G2792620](#) [MVC-E2502637](#) [MVC-B2114864](#) [MVX-F2752815](#) [MVC-F2867411](#) [MVX-B2674418](#) [MVX-G2831661](#) [MVX-D2210644](#) [MVC-A2666063](#) [MVC-F3107042](#) [MVX-E2440278](#)