

REV.	ECN NO.	DR	DATE

PRODUCT NO.	RoHS compliant
DSIC04TSGER	

NOTES :

- 1.Specification:
 - 1>.Operating force:1000gf Max
 - 2>.Operating Temperature:-40° to+85°
 - 3>.Storage Temperature:.-40° to+85°
 - 4>.Mechanical Life:3000cycles minimum
 - 5>.Electrical Life:2000cycles minimum
2. PLATING:

GOLD FLASH 1u"~2u" SOLDERTAIL,
1u"~3u" GOLD PLATING ON THE CONTACT AREA,
WITH 50u" NICKEL UNDERPLATINGOVERALL.

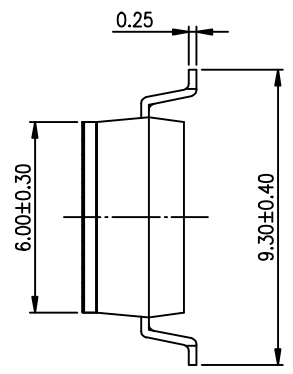
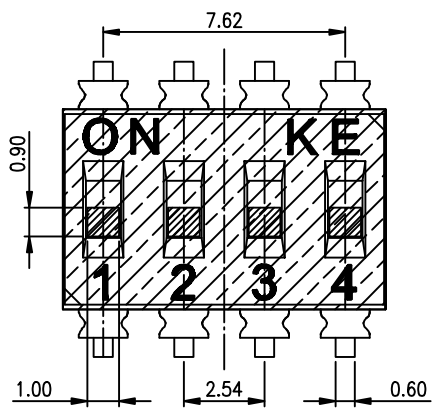

3. PART NUMBER DESCRIPTION

DSIC XX T S G E R

- [包装方式: T=管装 R=Reel]
- [电镀层:E=接触部 1u"~3u" /焊接部 1u"~2u"]
- [G=镀金 S=内金外镍]
- [脚型: S脚 / J脚 / H脚 / A脚 / Z脚]
- [T=低推贴胶 S=低推不贴胶 L=长推]
- [产距P数:02=2P 08=8P 10=10P 12=12P]

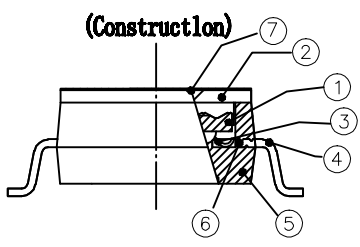
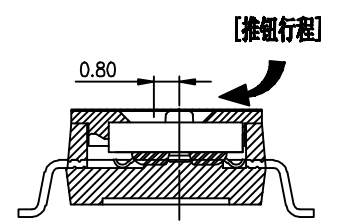
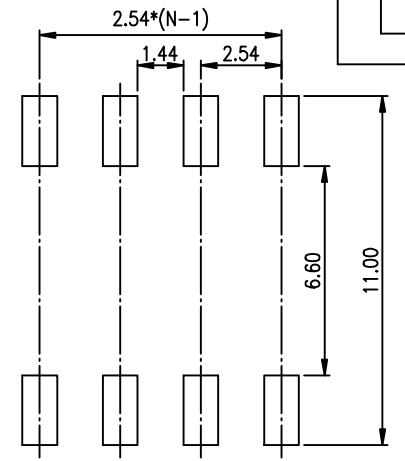
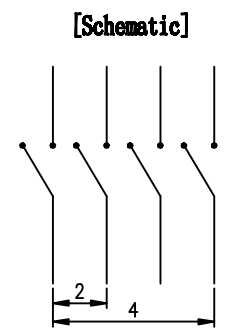
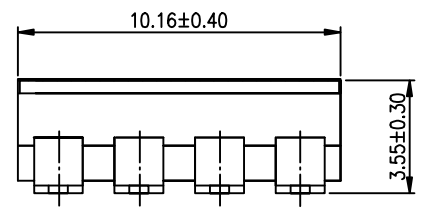

Number	Part Name	Material	Finished	TOLERANCE UNLESS OTHERWISE SPECIFIED		INSPECTION COPY
				LINER	ANGLES	
①	Actuator	UL94 V0	White	.0 ± 0.25	0. ± 2'	PROJECTION 2012/04/12
②	Cover	UL94 V0	Black	.00 ± 0.15	.0 ± 1'	
③	Movable	Copper Alloy	1u"~3u"Gold	.000± 0.10	.00± 0.5'	
④	Terminal	Brass	1u"~2u"Gold	DESIGN	kathy	
⑤	Base	UL94 V0	Black	DRAWING		
⑥	Terminal Contact	Brass	1u"~3u"Gold	CHECK		
⑦	Mylar	UL94 V0	0.05mm	APPRO.		

KE 东莞市广普实业有限公司
DongGuan Kingtek Industrial Co., Ltd.

TITLE
BY DSIC SERIES PITCH 2.54mm

PRODUCT FAMILY DSIC SERIES

PRAT NO. DSIC04TSGER

FILE NO. DSIC04TSGER-A

SIZE	UNIT	SCALE	SHEET	REV.
A4	mm	2 : 1	1 OF 1	A