

Product Specification

XBLW AO3400

N-Channel Enhancement Mode MOSFET

WEB | www.xinboleic.com



Description

The AO3400 uses advanced trench technology to provide excellent $R_{DS(ON)}$, low gate charge and operation with gate voltages as low as 2.5V. This device is suitable for use as a Battery protection or in other Switching application.

General Features

- $V_{DS} = 30V, I_D = 5.8A$
- $R_{DS(ON)} < 28m\Omega @ V_{GS}=10V$
- $R_{DS(ON)} < 34m\Omega @ V_{GS}=4.5V$

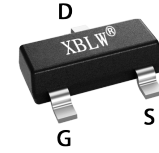
SOT-23-3L

Application

- High power and current handing capability
- Lead free product is acquired
- Surface mount package
- PWM applications
- Load switch
- Power management

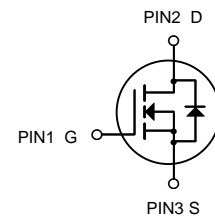

N-Channel MOSFET

Package Marking and Ordering Information

Product Model	Package Type	Marking	Packing	Packing Qty
XBLW AO3400	SOT-23-3L	X0VX	Tape	3000Pcs/Reel

Absolute Maximum Ratings (TA=25°C unless otherwise noted)

Symbol	Parameter	Limit	Unit
V_{DS}	Drain-Source Voltage	30	V
V_{GS}	Gate-Source Voltage	± 12	V
I_D	Drain Current-Continuous	5.8	A
I_{DM}	Drain Current-Pulsed ^(Note 1)	30	A
P_D	Maximum Power Dissipation	1.4	W
T_J, T_{STG}	Operating Junction and Storage Temperature Range	-55 To 150	°C
$R_{\theta JA}$	Thermal Resistance, Junction-to-Ambient ^(Note 2)	89	°C/W

Electrical Characteristics (TA=25°C unless otherwise noted)

Parameter	Symbol	Condition	Min	Typ	Max	Unit
Off Characteristics						
Drain-Source Breakdown Voltage	BV_{DSS}	$V_{GS}=0V, I_D=250\mu A$	30	33	-	V
Zero Gate Voltage Drain Current	I_{DSS}	$V_{DS}=30V, V_{GS}=0V$	-	-	1	μA
Gate-Body Leakage Current	I_{GSS}	$V_{GS}=\pm 12V, V_{DS}=0V$	-	-	± 100	nA
Gate Threshold Voltage	$V_{GS(th)}$	$V_{DS}=V_{GS}, I_D=250\mu A$	0.7	0.9	1.4	V
Drain-Source On-State Resistance	$R_{DS(on)}$	$V_{GS}=2.5V, I_D=4A$	-	41	55	m Ω
		$V_{GS}=4.5V, I_D=5A$	-	23	34	m Ω
		$V_{GS}=10V, I_D=5.8A$	-	21	28	m Ω
Forward Transconductance	g_{FS}	$V_{DS}=5V, I_D=5A$	10	-	-	S
Input Capacitance	C_{iss}	$V_{DS}=15V, V_{GS}=0V,$ $F=1.0MHz$	-	825	-	PF
Output Capacitance	C_{oss}		-	100	-	PF
Reverse Transfer Capacitance	C_{rss}		-	78	-	PF
Turn-on Delay Time	$t_{d(on)}$	$V_{DD}=15V, R_L=2.7\Omega$ $V_{GS}=10V, R_{GEN}=3\Omega$	-	3.3	-	nS
Turn-on Rise Time	t_r		-	4.8	-	nS
Turn-Off Delay Time	$t_{d(off)}$		-	26	-	nS
Turn-Off Fall Time	t_f		-	4	-	nS
Total Gate Charge	Q_g	$V_{DS}=15V, I_D=5.8A,$ $V_{GS}=4.5V$	-	10	-	nC
Gate-Source Charge	Q_{gs}		-	1.6	-	nC
Gate-Drain Charge	Q_{gd}		-	3.1	-	nC
Diode Forward Voltage ^(Note 3)	V_{SD}	$V_{GS}=0V, I_S=5.8A$	-	-	1.2	V
Diode Forward Current ^(Note 2)	I_S		-	-	5.8	A

Notes:

1. Repetitive Rating: Pulse width limited by maximum junction temperature.
2. Surface Mounted on FR4 Board, $t \leq 10$ sec.
3. Pulse Test: Pulse Width $\leq 300\mu s$, Duty Cycle $\leq 2\%$.
4. Guaranteed by design, not subject to production

Typical Electrical and Thermal Characteristics

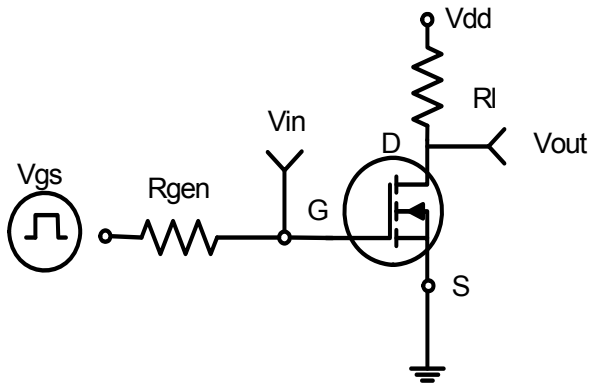

Figure 1: Switching Test Circuit

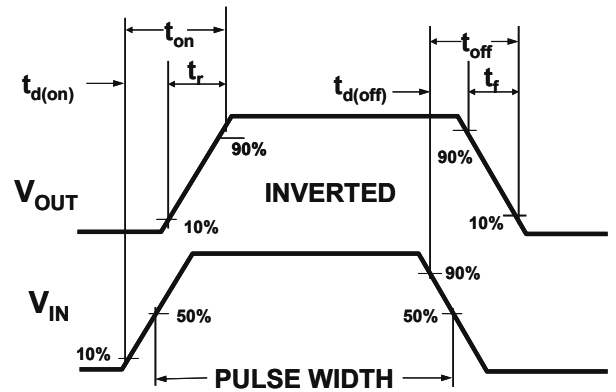

Figure 2: Switching Waveforms

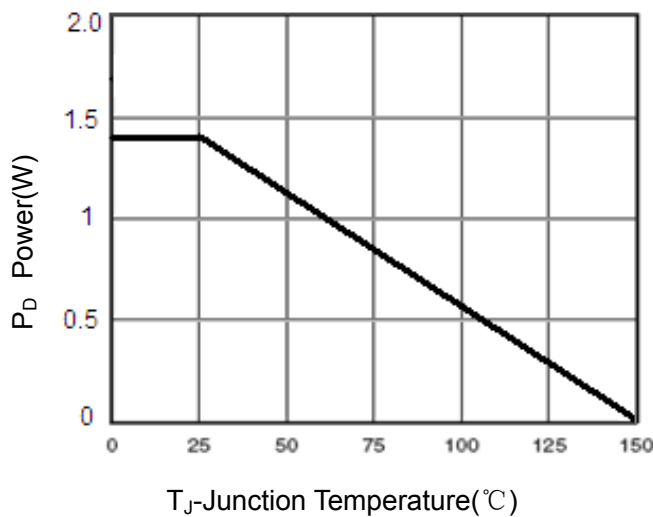

Figure 3 Power Dissipation

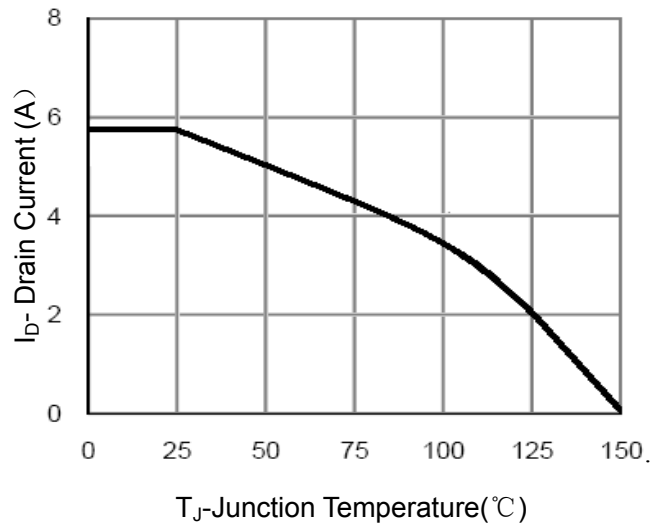

Figure 4 Drain Current

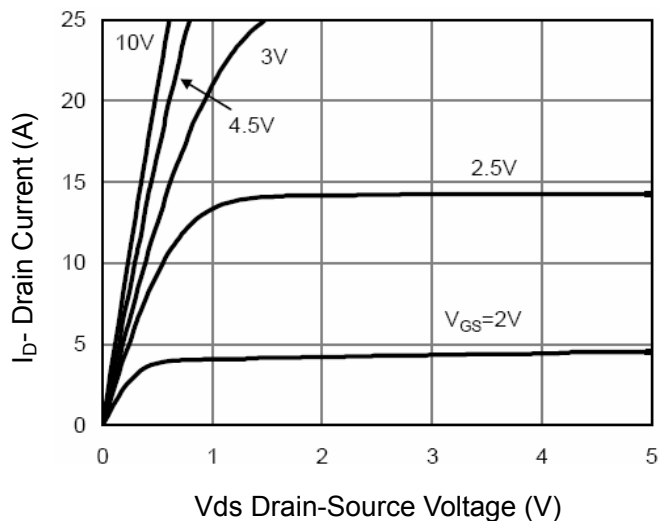

Figure 5 Output Characteristics

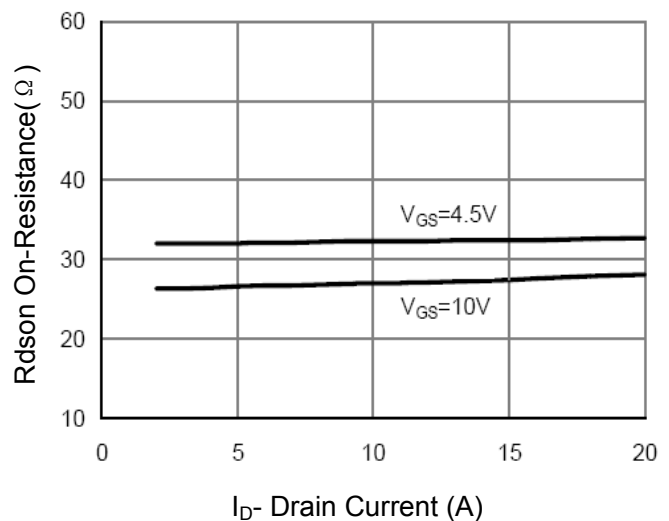

Figure 6 Drain-Source On-Resistance

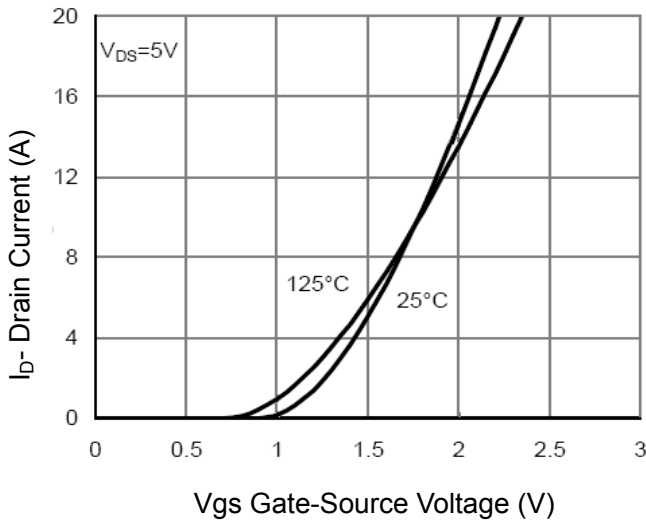

Figure 7 Transfer Characteristics

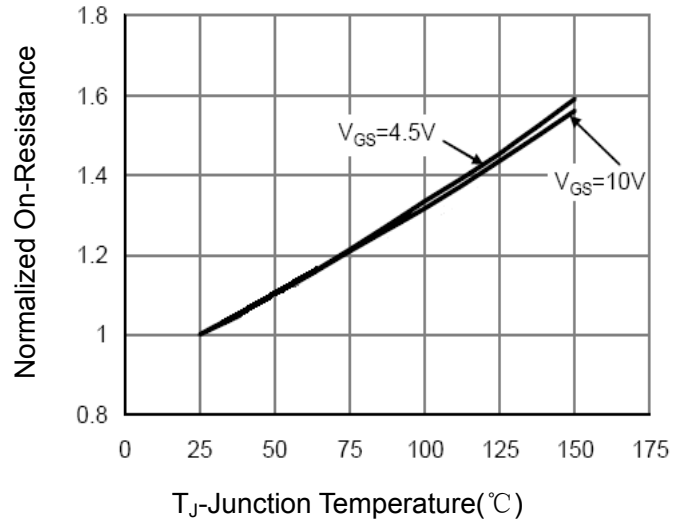

Figure 8 Drain-Source On-Resistance

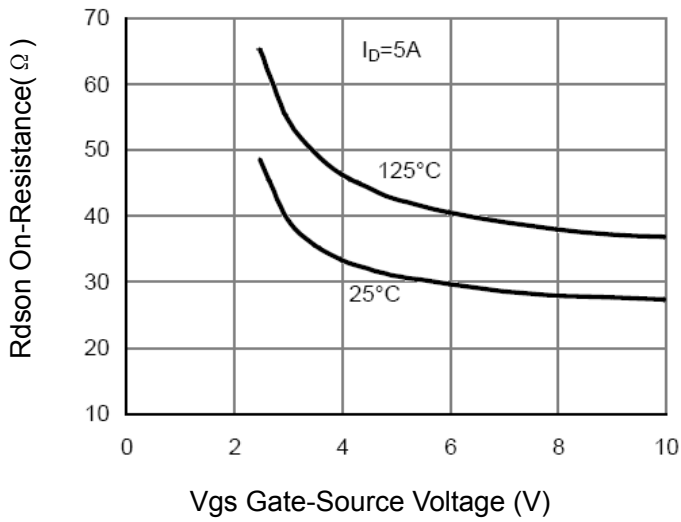

Figure 9 Rdson vs Vgs

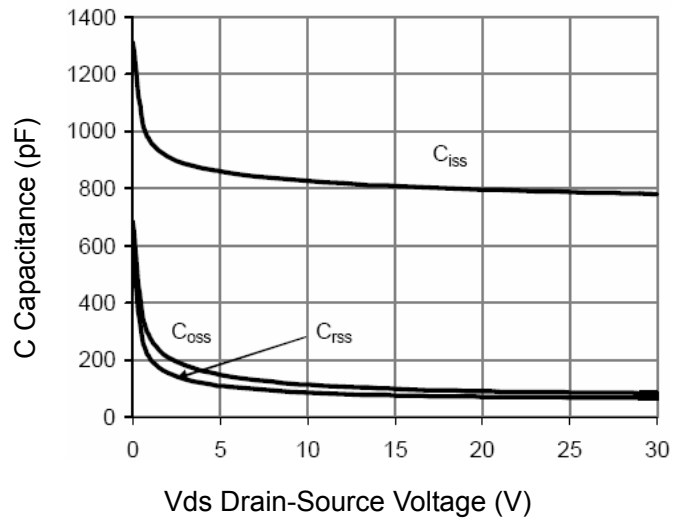

Figure 10 Capacitance vs Vds

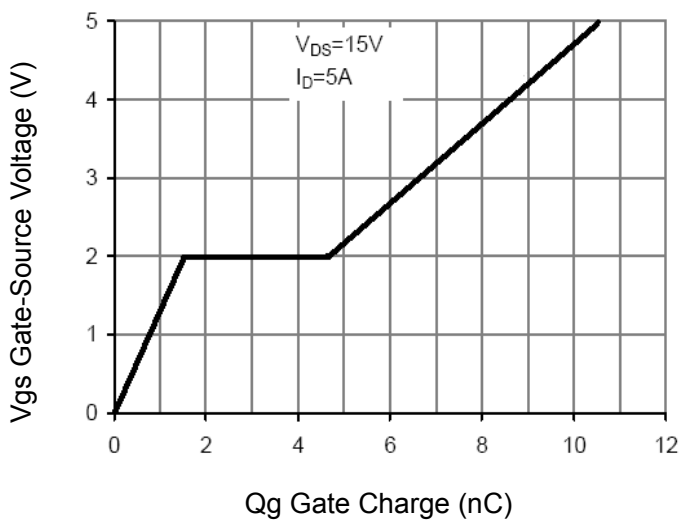

Figure 11 Gate Charge

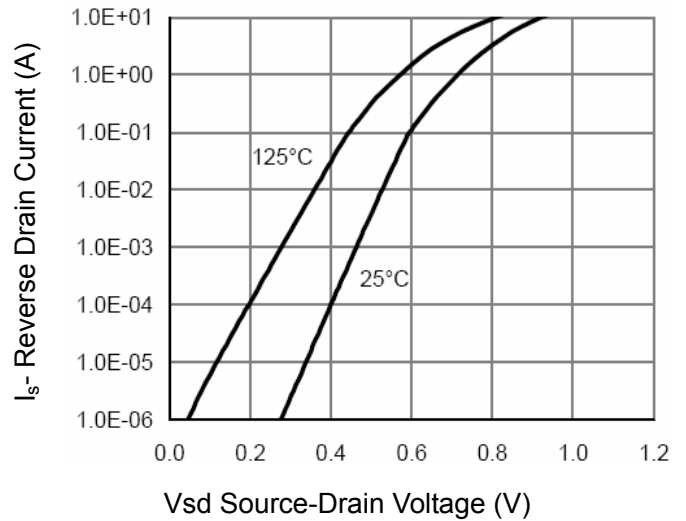

Figure 12 Source- Drain Diode Forward

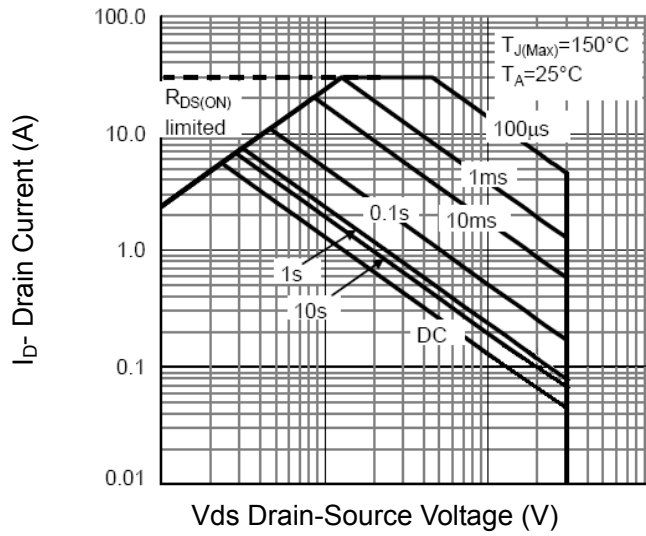

Figure 13 Safe Operation Area

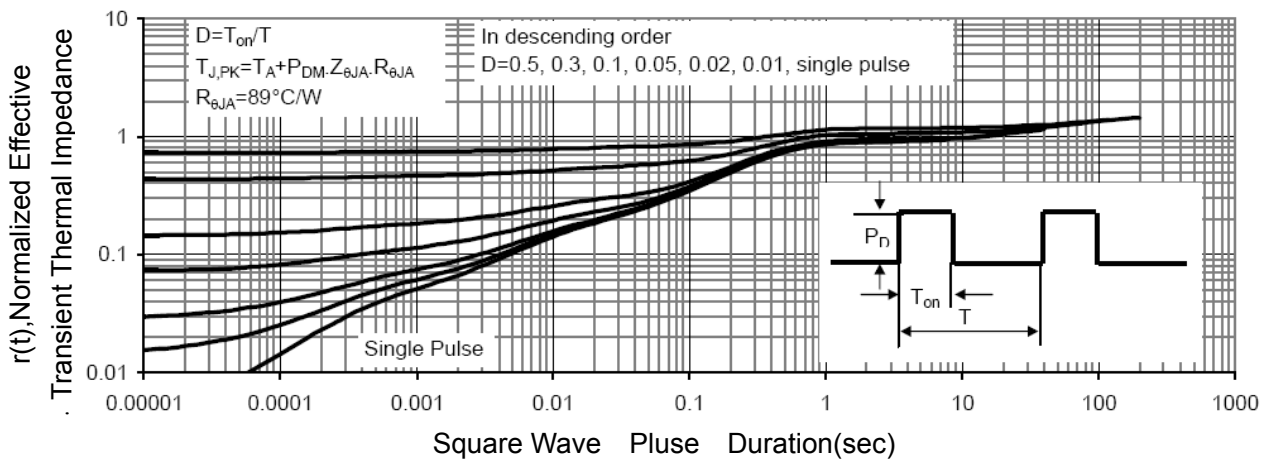
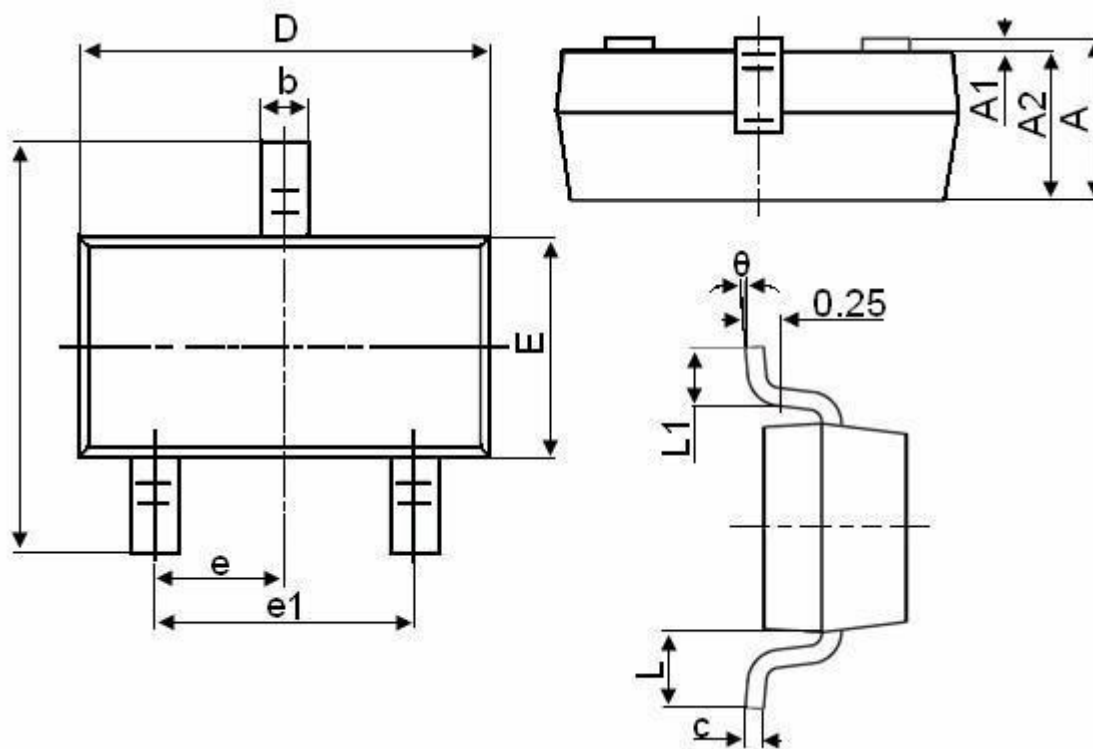

Figure 14 Normalized Maximum Transient Thermal Impedance

Package Information

SOT23-3L



Symbol	Dimensions in Millimeters	
	MIN.	MAX.
A	1.050	1.250
A1	0.000	0.100
A2	1.050	1.150
b	0.300	0.500
c	0.100	0.200
D	2.800	3.000
E	1.500	1.700
E1	2.650	2.950
e	0.950TYP	
e1	1.800	2.000
L	0.550REF	
L1	0.300	0.600
θ	0°	8°

Statement:

- XBLW reserves the right to modify the product manual without prior notice! Before placing an order, customers need to confirm whether the obtained information is the latest version and verify the completeness of the relevant information.
- Any semi-guide product is subject to failure or malfunction under specified conditions. It is the buyer's responsibility to comply with safety standards when using XBLW products for system design and whole machine manufacturing. And take the appropriate safety measures to avoid the potential in the risk of loss of personal injury or loss of property situation!
- XBLW products have not been licensed for life support, military, and aerospace applications, and therefore XBLW is not responsible for any consequences arising from the use of this product in these areas.
- If any or all XBLW products (including technical data, services) described or contained in this document are subject to any applicable local export control laws and regulations, they may not be exported without an export license from the relevant authorities in accordance with such laws.
- The specifications of any and all XBLW products described or contained in this document specify the performance, characteristics, and functionality of said products in their standalone state, but do not guarantee the performance, characteristics, and functionality of said products installed in Customer's products or equipment. In order to verify symptoms and conditions that cannot be evaluated in a standalone device, the Customer should ultimately evaluate and test the device installed in the Customer's product device.
- XBLW documentation is only allowed to be copied without any alteration of the content and with the relevant authorization. XBLW assumes no responsibility or liability for altered documents.
- XBLW is committed to becoming the preferred semiconductor brand for customers, and XBLW will strive to provide customers with better performance and better quality products.