

RECOMMENDED PCB LAYOUT

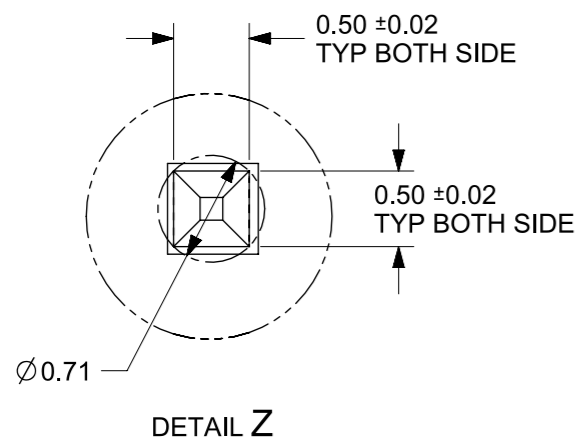
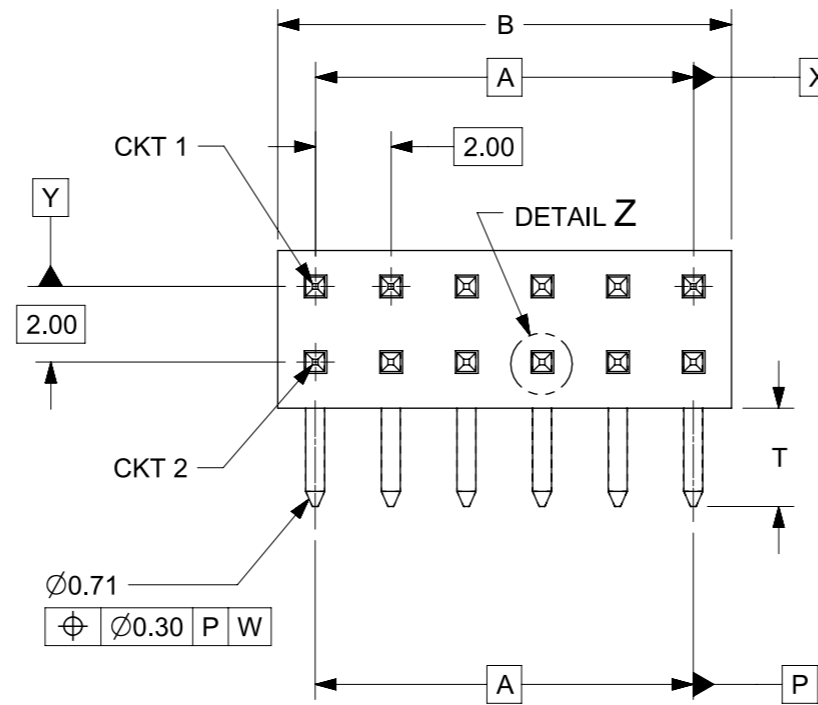
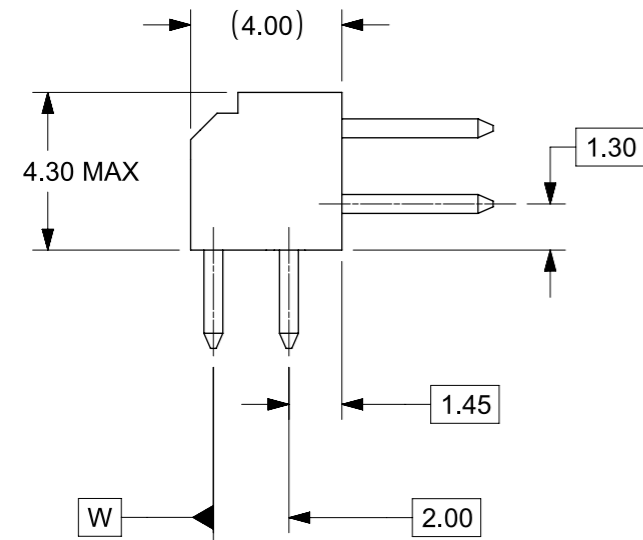
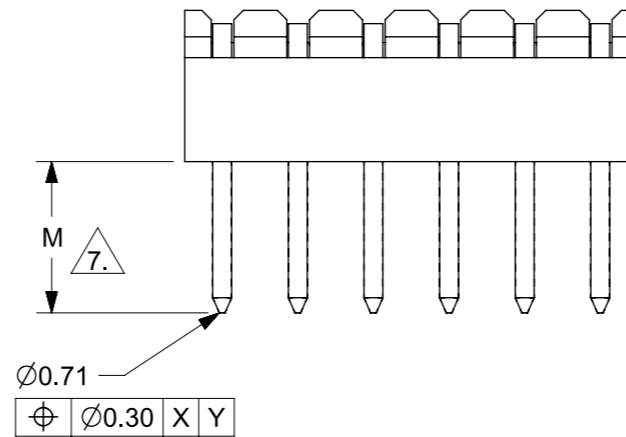

- NOTES:
- MATERIAL:
HSG: PCT, 30% GLASS FILLED, UL 94V-0, COLOUR BLACK.
PIN: 0.50MM SQ PHOSPHOR BRONZE 510
 - PLATING:
***5 - 0.05µm MIN - 0.25µm MAX GOLD IN CONTACT AREA, 2.00µm MIN TIN IN SOLDERTAIL AREA, BOTH OVER 1.25µm MIN NICKEL OVERALL

***6 - 0.38µm MIN GOLD IN CONTACT AREA, 2.00µm MIN TIN IN SOLDERTAIL AREA, BOTH OVER 1.25µm MIN NICKEL OVERALL

***7 - 0.76µm MIN GOLD IN CONTACT AREA, 2.00µm MIN TIN IN SOLDERTAIL AREA, BOTH OVER 1.25µm MIN NICKEL OVERALL

***8 - 2.54µm MIN TIN OVER 1.25µm MIN NICKEL OVERALL
 - 12 CKT USED FOR ILLUSTRATION ONLY
 - PART TO BE PACKED IN POCKET TRAY/TUBE (SEE TABLE).
 - PRODUCT SPEC PS-87761-100 APPLIES.
 - RECOMMENDED PCB BOARD THK 1.60±0.10 MM.
 - MATING LENGTH:
 - 1 - 4.00MM
 - 2 - 3.50MM
 - 3 - 3.06MM
 - 4 - 5.75MM
 - PART NUMBERS THAT ARE UNAVAILABLE IN THIS SD: 87760-0646, 87760-1046, 87760-1446, 87760-2446, 87760-4046. (REFER TO SD-87760-133 FOR THESE PART NUMBERS)







LEGEND:

8 7 7 6 0 - * * * *

PLATING OPTION (SEE NOTE 2) 2.

MATING OPTION 7.

THIS DRAWING CONTAINS INFORMATION THAT IS PROPRIETARY TO MOLEX ELECTRONIC TECHNOLOGIES, LLC AND SHOULD NOT BE USED WITHOUT WRITTEN PERMISSION											
DIMENSION UNITS		SCALE		CURRENT REV DESC:						molex	
mm		NTS									
GENERAL TOLERANCES (UNLESS SPECIFIED)				EC NO: 756033		DRWN: SUAIFR		2023/05/23		MGRID, 2MM DUAL ROW HDR. R/A	
				CHK'D: SUAIFR		2023/07/07					
				APPR: MRAMAKRISHNA		2023/07/10		PRODUCT CUSTOMER DRAWING			
				INITIAL REVISION:		DRWN: KSEE		2003/10/15		DOCUMENT NUMBER SD-87760-109	
				APPR: SKTOH		2003/12/11		DOC TYPE PSD			
				ANGULAR TOL ± 3.0°						REVISION A18	
DRAFT WHERE APPLICABLE MUST REMAIN WITHIN DIMENSIONS				THIRD ANGLE PROJECTION		DRAWING		SERIES			
						A3-SIZE		87760		CUSTOMER GENERAL MARKET	

PART NUMBER	VOID PIN LOCATION	CKT SIZE	A	B	M	T	PACKAGING TYPE
87760-04**	-	4	2.00	4.00			
87760-06** 	-	6	4.00	6.00			
87760-08**	-	8	6.00	8.00			
87760-10** 	-	10	8.00	10.00			
87760-12** 	-	12	10.00	12.00			
87760-14** 	-	14	12.00	14.00			
87760-16**	-	16	14.00	16.00			
87760-18**	-	18	16.00	18.00			
87760-20**	-	20	18.00	20.00			
87760-22**	-	22	20.00	22.00			
87760-24** 	-	24	22.00	24.00			
87760-26**	-	26	24.00	26.00			
87760-28**	-	28	26.00	28.00	REFER TO NOTE 	2.60	TRAY
87760-30**	-	30	28.00	30.00			
87760-32**	-	32	30.00	32.00			
87760-34**	-	34	32.00	34.00			
87760-36**	-	36	34.00	36.00			
87760-38**	-	38	36.00	38.00			
87760-40** 	-	40	38.00	40.00			
87760-42**	-	42	40.00	42.00			
87760-44**	-	44	42.00	44.00			
87760-46**	-	46	44.00	46.00			
87760-48**	-	48	46.00	48.00			
87760-50**	-	50	48.00	50.00			

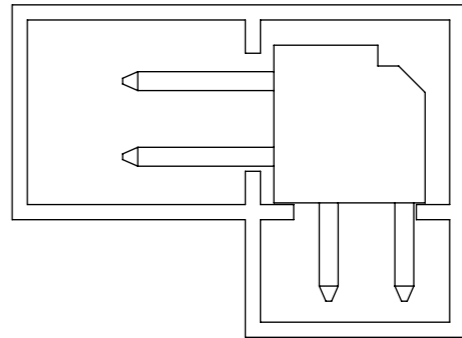

PART IN TUBE

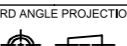
THIS DRAWING CONTAINS INFORMATION THAT IS PROPRIETARY TO MOLEX ELECTRONIC TECHNOLOGIES, LLC AND SHOULD NOT BE USED WITHOUT WRITTEN PERMISSION									
DIMENSION UNITS		SCALE		CURRENT REV DESC:				molex	
mm		NTS							
GENERAL TOLERANCES (UNLESS SPECIFIED)				EC NO: 756033		MGRID, 2MM DUAL ROW HDR.		R/A	
		MM	INCH	DRWN: SUAIFR		2023/05/23			
4 PLACES		±	±	CHK'D: SUAIFR		2023/07/07			
3 PLACES		±	±	APPR: MRAMAKRISHNA		2023/07/10		PRODUCT CUSTOMER DRAWING	
2 PLACES		± 0.2	±	INITIAL REVISION:		DOCUMENT NUMBER		DOC TYPE	DOC PART
1 PLACE		±	±	DRWN: KSEE		2003/10/15		REVISION	
0 PLACES		±	±	APPR: SKTOH		2003/12/11		SD-87760-109	
ANGULAR TOL		± 3.0°		THIRD ANGLE PROJECTION		DRAWING	SERIES	MATERIAL NUMBER	CUSTOMER
DRAFT WHERE APPLICABLE MUST REMAIN WITHIN DIMENSIONS				A3-SIZE	87760	SEE TABLE	GENERAL MARKET	SHEET NUMBER	
								2 OF 3	

9 8 7 6 5 4 3 2 1

PART NUMBER	VOID PIN LOCATION	CKT SIZE	A	B	M	T	PACKAGING TYPE
87760-5116	5, 6 & 26	50	48.00	50.00	REFER TO NOTE 	2.60	TUBE
87760-531*	-	24	22.00	24.00		1.50	TRAY
87760-5216	-	04	2.00	4.00		2.60	TUBE
87760-5416	-	20	18.00	20.00			
87760-5248	-	28	26.00	28.00			
87760-5516	5, 6, 7, 8, 9, 10, 15, 16, 17, 18, 19, 20, 25, 26, 27, 28, 29, 30	34	32.00	34.00			
87760-0856	-	08	6.00	8.00	2.60	2.10	TRAY

(A18)

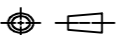
THIS DRAWING CONTAINS INFORMATION THAT IS PROPRIETARY TO MOLEX ELECTRONIC TECHNOLOGIES, LLC AND SHOULD NOT BE USED WITHOUT WRITTEN PERMISSION											
DIMENSION UNITS		SCALE		CURRENT REV DESC:				 MGRID, 2MM DUAL ROW HDR. R/A			
mm		NTS									
GENERAL TOLERANCES (UNLESS SPECIFIED)				EC NO: 756033				DOCUMENT NUMBER: SD-87760-109 DOC TYPE: PSD DOC PART: 001 REVISION: A18			
				DRWN: SUAIFR 2023/05/23							
				CHK'D: SUAIFR 2023/07/07				PRODUCT CUSTOMER DRAWING			
				APPR: MRAMAKRISHNA 2023/07/10							
4 PLACES ±				INITIAL REVISION:				MATERIAL NUMBER: SEE TABLE CUSTOMER: GENERAL MARKET SHEET NUMBER: 3 OF 3			
3 PLACES ±				DRWN: KSEE 2003/10/15							
2 PLACES ± 0.2				APPR: SKTOH 2003/12/11							
1 PLACE ±				ANGULAR TOL ± 3.0°							
0 PLACES ±				DRAFT WHERE APPLICABLE MUST REMAIN WITHIN DIMENSIONS				THIRD ANGLE PROJECTION 			
DRAWING		SERIES		MATERIAL NUMBER		CUSTOMER		SHEET NUMBER			
A3-SIZE		87760		SEE TABLE		GENERAL MARKET		3 OF 3			

9 8 7 6 5 4 3 2 1

FORMAT: Mef-8941-master-b-prod-A3
 REVISION: 0
 DATE: 2017/10/06