



Quality Products. Service Excellence.

Heavy Current Chassis Mount 195-196 Series

**NEW
SIZES**



Features

- Open core & coil, 4-slot bracket mounting chokes.
- Tolerance of 15% on both inductance & resistance.
- Inductances measured at rated D.C. current.
- The "195" series is single coil
- The "196" series is dual coil - allowing more versatility
- Recommended maximum operating voltage 600 VAC (winding to core).
- Hipot tested at 2,500 VAC
- Connections are made to a screw terminal or heavy copper tabs with holes
- Perfect for high current power supply filtering.



RoHS

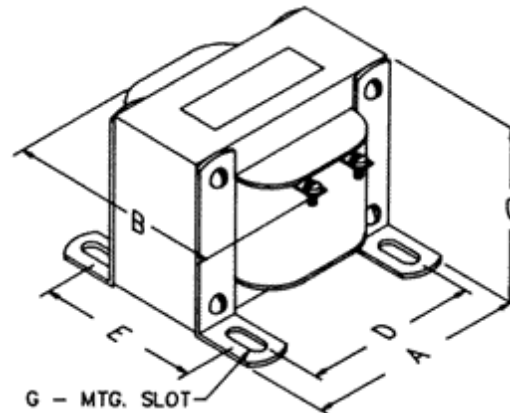

195 Series

Part No.	Inductance mH (Millihenries)	D.C. Current (Amps)	Resistance (Ohms)	Insulation Class	Dimensions					Mounting Slot		Weight (lbs.)	
					A	B	C	D	E	G			
195A200	0.3	200	0.0012	-	7.50	7.00	6.50	6.00	5.25	0.28	x	0.56	46
195B100	0.5	100	0.002	-	6.38	6.25	5.38	5.25	4.13	0.28	x	0.56	31
195B150	0.5	150	0.0018	B	5.25	5.50	4.47	4.38	4.13	0.28	x	0.56	26
195C20	1	20	0.013	A	3.00	3.06	2.50	2.50	2.25	0.20	x	0.38	3
195C30	1	30	0.009	A	3.75	3.85	3.13	3.13	2.50	0.20	x	0.38	6
195C50	1	50	0.005	A	4.50	5.25	3.75	3.75	3.50	0.20	x	0.38	14.5
195C75	1	75	0.004	A	5.25	6.00	4.47	4.38	4.63	0.28	x	0.56	23
195C100	1	100	0.0036	B	5.25	6.50	4.47	4.38	5.13	0.28	x	0.56	26
195D50	1.4	50	0.005	-	6.38	5.50	5.38	5.25	3.88	0.28	x	0.56	28
195E20	2.5	20	0.022	A	3.75	4.20	3.13	3.13	2.75	0.20	x	0.38	6.5
195E30	2.5	30	0.013	A	4.50	5.25	3.75	3.75	3.50	0.20	x	0.38	12.5
195E50	2.5	50	0.008	A	5.25	6.00	4.47	4.38	4.63	0.28	x	0.56	23.5
195E75	2.5	75	0.008	B	6.00	6.63	5.16	5.00	4.88	0.28	x	0.56	32.5
195E100	2.5	100	0.006	B	9.00	9.75	7.50	7.00	6.00	0.44	x	0.75	88
195F30	4	30	0.018	-	6.38	5.00	5.38	5.25	3.25	0.28	x	0.56	23
195G10	5	10	0.04	A	3.75	3.60	3.13	3.13	2.25	0.20	x	0.38	5.5
195G20	5	20	0.025	A	4.50	4.75	3.75	3.75	3.00	0.20	x	0.38	10.5
195G25	5	25	0.014	-	5.25	6.00	4.44	4.38	3.63	0.28	x	0.56	18
195G30	5	30	0.023	A	5.25	5.00	4.47	4.38	3.63	0.28	x	0.56	16

Part No.	Inductance mH (Millihenries)	D.C. Current (Amps)	Resistance (Ohms)	Insulation Class	Dimensions					Mounting Slot		Weight (lbs.)	
					A	B	C	D	E	G			
195G50	5	50	0.021	B	7.50	6.50	6.25	6.00	4.50	0.38	x	0.63	38
195G75	5	75	0.01	B	9.00	9.50	7.76	7.00	7.00	0.44	x	0.75	87
195H20	7	20	0.062	-	5.25	6.00	4.44	4.38	3.63	0.28	x	0.56	17
195J10	10	10	0.07	A	3.75	4.35	3.13	3.13	3.00	0.20	x	0.38	8
195J12	10	12.5	0.072	B	4.12	3.25	3.44	3.44	2.34	0.20	x	0.38	-
195J20	10	20	0.045	A	5.25	5.00	4.47	4.38	3.63	0.28	x	0.56	17.5
195J30	10	30	0.037	A	6.00	7.50	5.00	5.00	5.88	0.31	x	0.50	36
195J50	10	50	0.023	B	9.00	9.75	7.50	7.00	6.25	0.44	x	0.75	79
195K12	15	12	0.062	-	5.25	5.50	4.44	4.38	3.13	0.28	x	0.56	14
195K16	15	16	0.062	-	5.25	6.00	4.44	4.38	3.63	0.28	x	0.56	17
195M10	20	10	0.013	A	4.50	4.75	3.75	3.75	3.00	0.20	x	0.38	10.2
195M20	20	20	0.075	A	6.00	7.50	5.00	5.00	5.88	0.31	x	0.50	34
195M30	20	30	0.045	B	6.00	7.63	5.16	5.00	5.88	0.28	x	0.56	41
195P5	30	5	0.23	A	3.75	4.20	3.13	3.13	2.75	0.20	x	0.38	6.5
195P8	30	8	0.3	-	4.12	3.75	3.50	3.43	3.00	0.20	x	0.38	-
195P10	30	10	0.17	A	4.50	5.25	3.75	3.75	3.50	0.20	x	0.38	16
195P20	30	20	0.13	B	5.25	6.91	4.47	4.38	5.54	0.28	x	0.56	28
195Q2	35	2	0.61	B	2.63	2.00	2.21	2.19	1.75	0.19	x	0.38	-
195Q6	40	6	0.4	-	3.75	3.62	3.25	3.12	3.00	0.20	x	0.38	-
195R10	50	10	0.165	A	5.25	5.50	4.47	4.38	4.13	0.28	x	0.56	26
195R20	50	20	0.13	B	9.00	8.25	7.50	7.00	5.75	0.44	x	0.75	72
195S2	70	2	0.9	-	3.37	2.75	2.87	2.81	2.12	0.20	x	0.38	-
195S4	70	4	0.6	-	3.75	3.25	3.13	3.13	2.50	0.20	x	0.38	-
195T1	100	1	1.5	-	3.00	2.50	2.50	2.50	2.00	0.20	x	0.38	-
195T5	100	5	0.64	A	4.50	5.25	3.75	3.75	3.50	0.20	x	0.38	14
195T10	100	10	0.42	B	7.50	6.00	6.25	6.00	4.25	0.38	x	0.63	35

196 Series - Dual Coil - Heavy Current Chokes

Part No.	Parallel Connected		Series Connected		Resistance (Each Winding) (Ohms)	Insulation Class	Overall Dimensions					Mounting Slot G	Weight (lbs.)
	Inductance mH (Millihenries)	D.C. Current (Amps)	Inductance mH (Millihenries)	D.C. Current (Amps)			A	B	C	D	E		
196B50	0.125	100	0.5	50	0.018	-	4.50	4.50	3.75	3.75	3.00	0.28 x 0.56	9.05
196D25	0.3	50	1.2	25	0.005	-	3.75	4.25	3.13	3.13	2.75	0.28 x 0.56	6.45
196G12	1.2	24	4.8	12	0.024	-	3.38	3.56	2.81	2.81	3.00	0.20 x 0.38	6
196K6	3	12	12	6	0.056	-	3.37	3.06	2.81	2.81	2.50	0.20 x 0.38	4.45
196M4	5	8	20	4	0.11	-	3.00	2.87	2.50	2.50	2.50	0.20 x 0.38	3.3
196Q2	10	4	40	2	0.24	-	3.12	2.12	2.75	2.81	-	0.19	1.85
196S1	18	2	72	1	0.553	-	2.00	2.00	2.31	2.38	-	0.19	1.4

Data subject to change without notice

© 2018. Hammond Manufacturing Ltd. All rights reserved.

Mouser Electronics

Authorized Distributor

Click to View Pricing, Inventory, Delivery & Lifecycle Information:

Hammond:

[195E100](#) [195P5](#) [195T5](#) [195P10](#) [195P20](#) [195T10](#) [195R10](#) [195R20](#) [195J50](#) [195J10](#) [195J30](#) [195J20](#) [195C100](#)
[195B150](#) [195C75](#) [195C30](#) [195C50](#) [195C20](#) [195G20](#) [195G50](#) [195G10](#) [195G30](#) [195G75](#) [195M30](#) [195M10](#)
[195M20](#) [195E20](#) [195E50](#) [195E75](#) [195E30](#) [195P8](#) [195S4](#) [196G12](#) [196M4](#) [195Q6](#) [195S2](#) [196Q2](#) [195T1](#) [196K6](#)
[195K12](#) [195A200](#) [196D25](#) [195H20](#) [196S1](#) [195K16](#) [195G25](#) [195D50](#) [195B100](#) [195J12](#) [196B50](#) [195F30](#)