



佛山市国星光电股份有限公司

FOSHAN NATIONSTAR OPTOELECTRONICS CO., LTD

# 产品规格书

## SPECIFICATION

顾客名称 Customer		产品名称 Product	光电耦合器
顾客型号 Customer Type		产品型号 Type	FOC-817X-XX
顾客部品号 Customer No.		版本号 Version NO	A 版



地址: 广东省佛山市禅城区华宝南路 18 号

Add: NO.18 South Huabao Rd,Foshan,Guangdong,China

电话 (Tel): (光电子销售: 0757-82100219)

传真 (Fax): (光电子销售: 0757-82100220)

邮编 (Zip): 528000

<http://www.nationstar.com>

XXX 研发部 Research & Development			客户 (加盖公章) Customer (Stamp)
制定 DRAW	审核 CHECK	批准 APPROVE	确认 CONFIRM
发放日期 (Release Date): 2022-09-23			

## 一、概述 Description

FOC-817 是一款 DIP-4 引脚封装的光电耦合器，产品由一个红外发光二极管和一个光电晶体管组成；光耦器件可实现不同电路之间的电气隔离和信号传输，产品广泛应用于电源设备上，例如手机充电器，家电产品电源供应器等。

FOC-817 is a DIP photocoupler-in-4 pin package, Consisting of an infrared light-emitting diode and a phototransistor;The devices can realize electrical isolation and signal transmission between different circuits,The products are widely used in power supply equipment, such as mobile phone charger, home appliance product power supply device, etc.

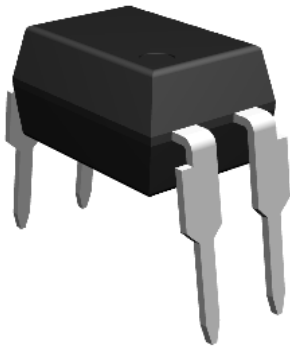

### Schematic

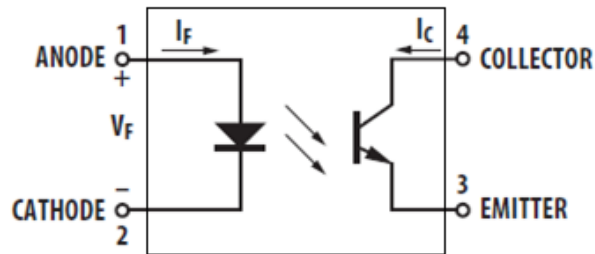

### 引脚排列 Pin Configuration

1. 正极 Anode
2. 负极 Cathode
3. 发射极 Emitter
4. 集电极 Collector

## 二、特性 Features

◇ 电流转换比(CTR: 50%-600% @ $I_F=5\text{mA}$ ,  $V_{CE}=5\text{V}$ )

Current transfer ratio (CTR: 50%-600% @ $I_F=5\text{mA}$ ,  $V_{CE}=5\text{V}$ )

◇ 输入-输出隔离电压: ( $V_{ISO}=5,000\text{Vrms}$ )

High isolation voltage between input and output( $V_{ISO}=5,000\text{Vrms}$ )

◇ 爬电距离 $>7.62\text{mm}$

Creepage distance  $> 7.62\text{mm}$

◇ 工作温度最高可达 $+110^\circ\text{C}$

Operating temperature up to  $+110^\circ\text{C}$

◇ 集电极-发射极击穿电压  $BV_{CEO} \geq 80\text{V}$

Collector-Emitter voltage  $BV_{CEO} \geq 80\text{V}$



### 三、电性参数 Electrical Characteristics

◇最大绝对额定值 (常温=25℃)

**Absolute Maximum Ratings (Temperature=25 °C)**

参数名称 Parameter		符号 Symbol	数值 Rating	单位 Unit
输入 Input	正向电流 Forward Current	$I_F$	50	mA
	反向电压 Reverse Voltage	$V_R$	6	V
	功耗 Power Dissipation	$P_D$	70	mW
输出 Output	集电极-发射极电压 Collector-Emitter voltage	$V_{CEO}$	80	V
	发射极-集电极电压 Emitter-Collector voltage	$V_{ECO}$	6	
	集电极电流 Collector current	$I_C$	50	mA
	功耗 Power Dissipation	$P_C$	180	mW
总功率消耗 Total Power Dissipation		$P_{tot}$	200	mW
*1 隔离电压 *1 Isolation Voltage		$V_{iso}$	5,000	Vrms
工作温度 Operating Temperature		$T_{opr}$	-55 to + 110	℃
存贮温度 Storage Temperature		$T_{stg}$	-55 to + 125	
*2 焊锡温度 *2 Soldering Temperature		$T_{sol}$	260	

\* 注:

\*1.交流测试, 时间 1 分钟, 湿度. =40~60%;

\*1.AC For 1 Minute, R.H. = 40 ~ 60%;

隔离电压测试的方法如下:

Isolation voltage shall be measured using the following method:

(1) 将产品的两端短路;

(1) Short between anode and cathode on the primary side and between collector and emitter on the secondary side;

(2) 测试隔离电压时无电流通过;

(2) The isolation voltage tester with zero-cross circuit shall be used;

(3) 测试时加正弦波形电压。

(3) The waveform of applied voltage shall be a sine wave.

\*2.锡焊时间为 10 秒

\*2. Soldering time is 10 seconds



◇ 电性参数 (温度=25℃):

**Electrical Characteristics (Temperature=25 °C)**

参数名称 Parameter	符号 Symbol	条件 Condition	最小值 Min.	典型值 Typ.	最大值 Max.	单位 Unit	
输入 Input	正向电压 Forward Voltage	$V_F$	$I_F=20mA$	---	1.2	1.4	V
	反向电流 Reverse Current	$I_R$	$V_R=4V$	---	---	10	$\mu A$
	终端电容 Terminal Capacitance	$C_t$	$V=0, f=1MHz$	---	30	250	pF
输出 Output	集电极暗电流 Collector dark current	$I_{CEO}$	$V_{CE}=20V, I_F=0$	---	---	100	nA
	集电极-发射极击穿电压 Collector-Emitter breakdown voltage	$BV_{CEO}$	$I_C=0.1mA$ $I_F=0$	80	---	---	V
	发射极-集电极击穿电压 Emitter-Collector breakdown voltage	$BV_{ECO}$	$I_E=10\mu A$ $I_F=0$	6	---	---	V
传输特性 transfer characteristic	集电极电流 Collector Current	$I_c$	$I_F=5mA$	2.5	---	30	mA
	*1 电流转换比 *1 Current conversion ratio	CTR	$V_{CE}=5V$	50	---	600	%
	集电极-发射极饱和电压 Collector-Emitter Saturation Voltage	$V_{CE(sat)}$	$I_F=20mA$ $I_C=1mA$	---	0.1	0.2	V
	绝缘电阻 Isolation resistance	$R_{iso}$	DC500V 40~60%R.H.	$5 \times 10^{10}$	$1 \times 10^{11}$	---	$\Omega$
	隔离电容 Floating Capacitance	$C_f$	$V=0, f=1MHz$	---	0.6	1	pF
	转换频率 Cut-off Frequency	$f_c$	$V_{CE}=5V, I_C=2mA$ $R_L=100\Omega, -3dB$	---	80	---	kHz
	上升时间 Rise time	$t_r$	$V_{CE}=2V, I_C=2mA$	---	4	18	$\mu s$
	下降时间 Fall time	$t_f$	$R_L=100\Omega$	---	3	18	$\mu s$

注: \*1 电流转换比=  $I_C / I_F \times 100\%$ , 公差 $\pm 3\%$ 。

\*1 Current Conversion Ratio =  $I_C / I_F \times 100\%$ , Tolerance:  $\pm 3\%$ 。

◇ 电流转换比等级表(温度=25℃):

**Rank Table of Current Transfer Ratio(Temperature=25 °C)**

等级标识 Grade Sign	最小.Min (%)	最大.Max (%)
L	50	100
A	80	160
B	130	260
C	200	400
D	300	600
L or A or B or C or D	50	600

四、外形尺寸 (单位: mm) Package Dimension (Unit: mm)

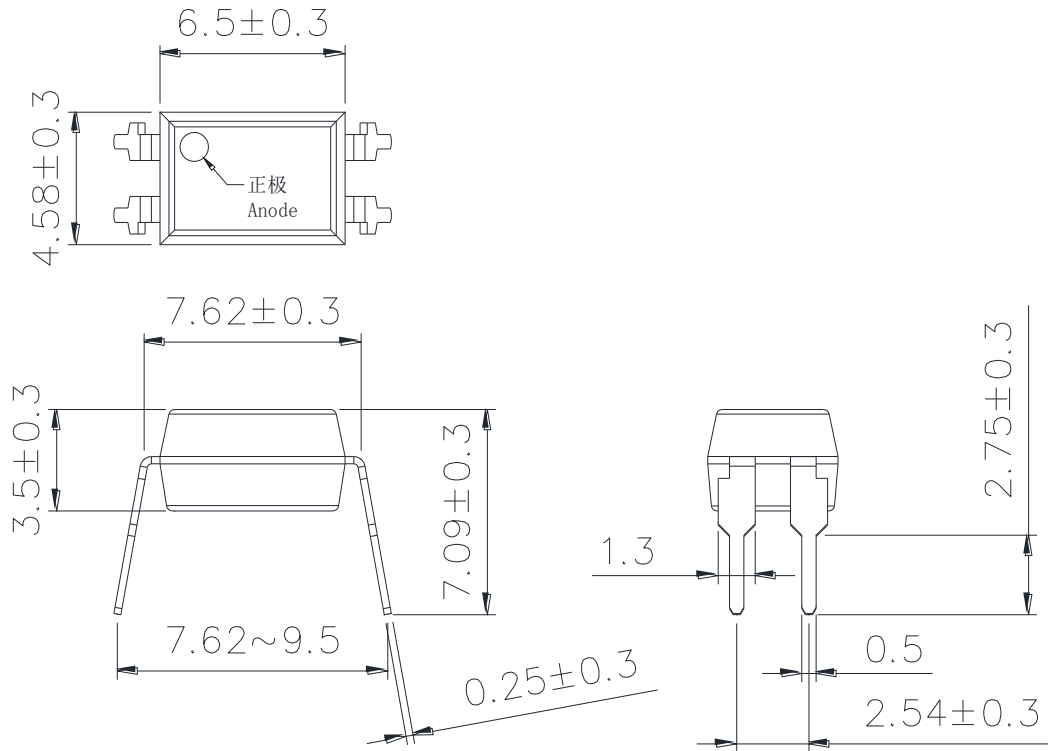

未注公差: ±0.1mm

The Tolerances Unless Mentioned is : ±0.1mm

五、产品印字 Device Marking

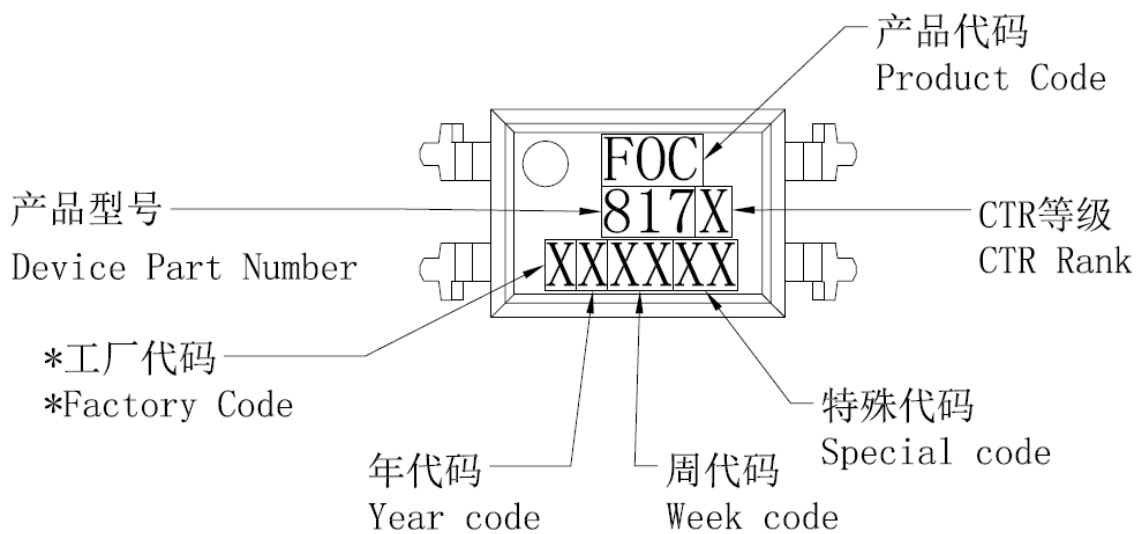

\*备注: 华宝厂区: H;  
\*Note: HuaBao Factory: H;

## 六、特性曲线 Characteristics Curves

Fig.1 正向电流与环境温度特性曲线  
Forward Current vs. Ambient Temperature

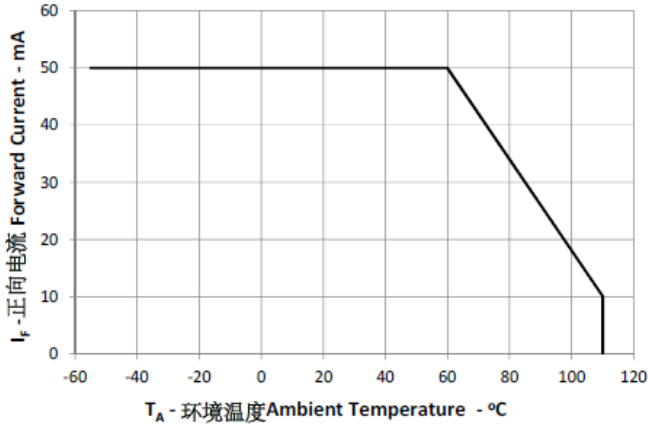

Fig.2 正向电流与正向压降特性曲线  
Forward Current vs. Forward Voltage

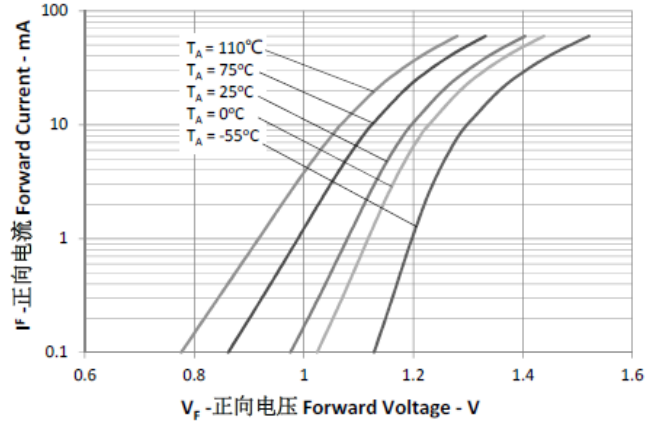

Fig.3 集电极功耗与环境温度特性曲线  
Collector Power Dissipation vs. Ambient Temperature

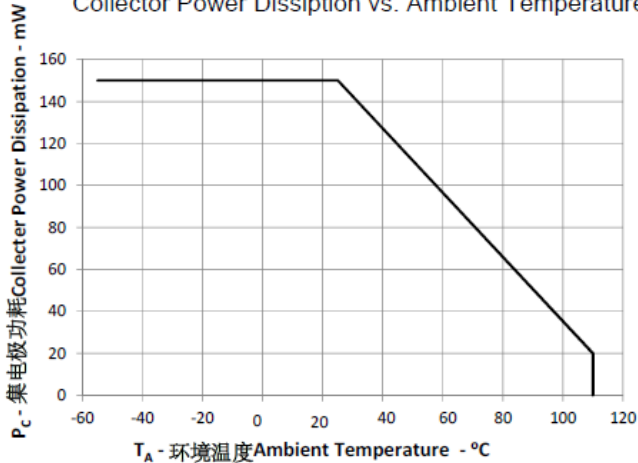

Fig.4 集电极电流与集电极-发射极电压特性曲线  
Collector Current vs. Collector-emitter Voltage

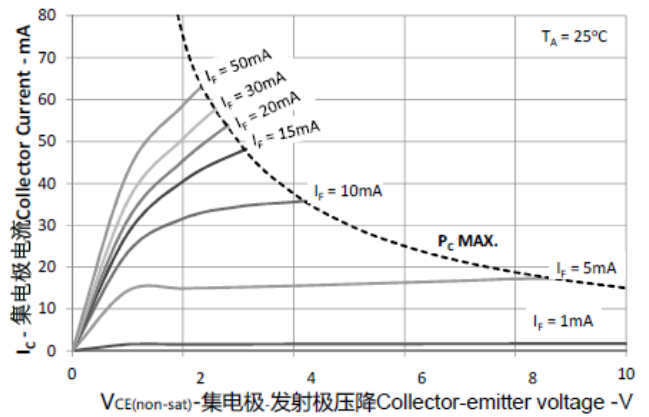

Fig.5 电流转换比与正向电流特性曲线  
Current Transfer Ratio vs. Forward Current

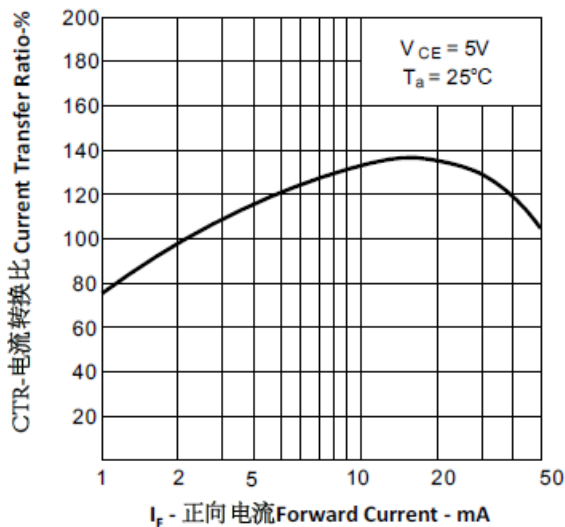

Fig.6 相对电流转换比与环境温度特性曲线  
Relative Current Transfer Ratio vs. Ambient Temperature

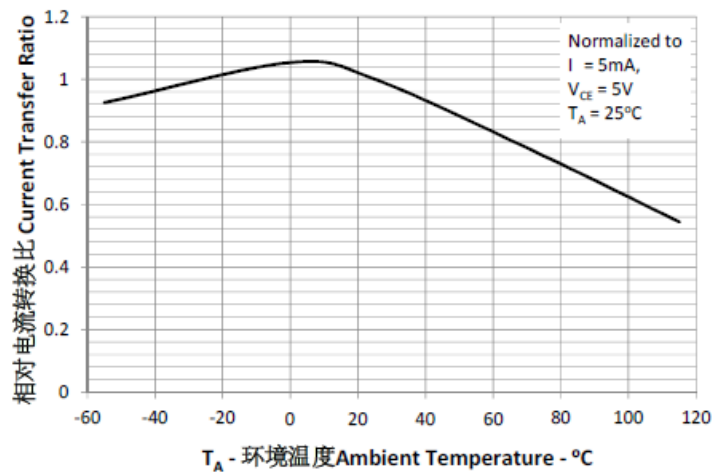

Fig.7 集电极-发射极饱和压降与环境温度特性曲线  
Collector-emitter Saturation Voltage vs. Ambient Temperature

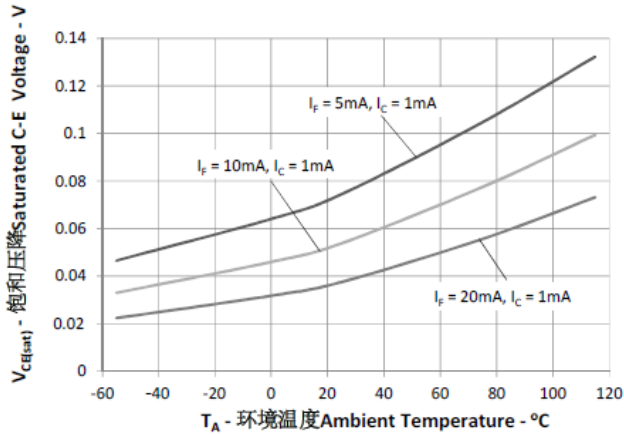

Fig.8 集电极暗电流与环境温度特性曲线  
Collector Dark Current vs. Ambient Temperature

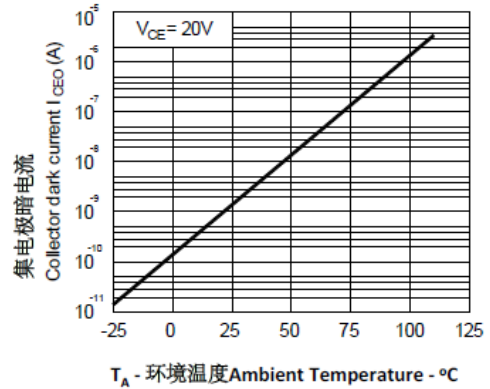

Fig.9 集电极-发射极饱和压降与正向电流特性曲线  
Collector-emitter Saturation Voltage vs. Forward Current

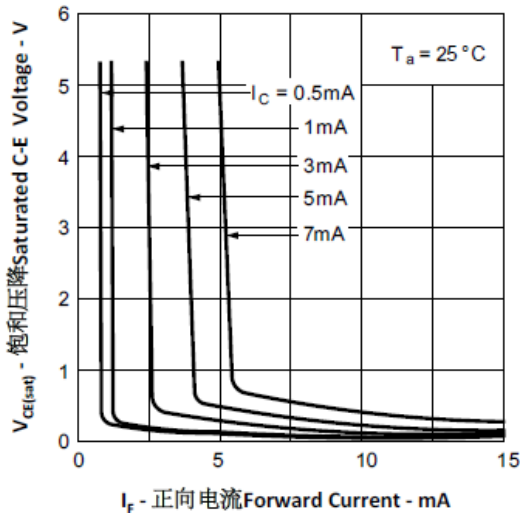

Fig.10 响应时间与负载电阻特性曲线  
Response Time vs. Load Resistance

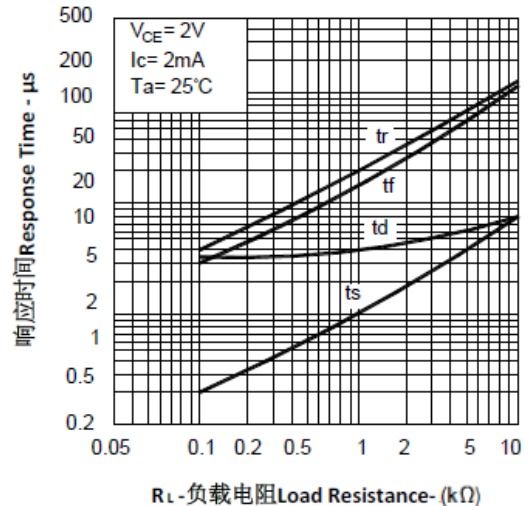
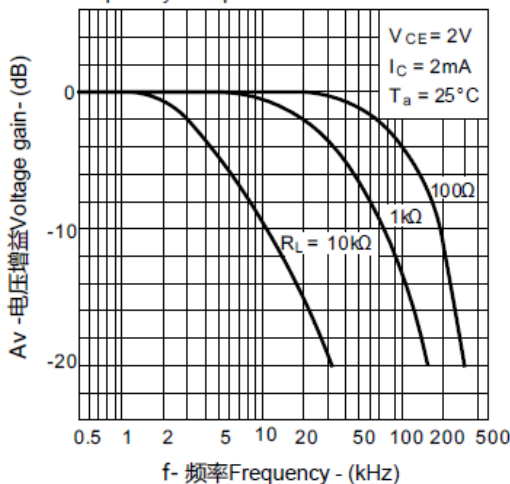
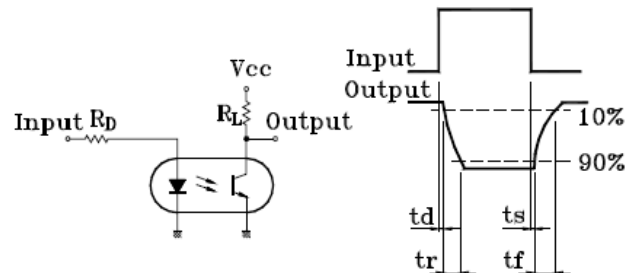

Fig.11 频率响应特性曲线  
Frequency Response



响应时间测试电路 Test Circuit for Response Time



频率响应测试电路 Test Circuit for Frequency Response

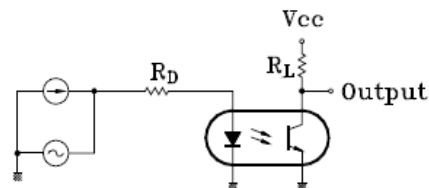



### 七、可靠性测试 Reliability Test Items And Conditions

实验项目 Test Items	参考标准 Reference	实验条件 Test Conditions	时间 Time	样品数 Quantity	判据 Criterion
可焊性 Solderability	JESD22-B102	Tsol= (245±5) °C, t=5s;	1次 1 times	22	0/22
耐焊接热 Resistance to Soldering Heat	JESD22-A106	Tsol= (260±5) °C, t=10s	3次 3 times	22	0/22
静电放电 ESD-HBM	JESD22-A114	Ta=25°C, HBM (2000V)	正反各3次 P&N 3 times	10	0/10
高温贮存 High Temperature Storage	JESD22-A103	Ta=125°C	1000h	22	0/22
低温贮存 Low Temperature Storage	JESD22-A119	Ta= -55°C	1000h	22	0/22
冷热冲击 Thermal Shock	JESD22-A104	-55°C(15min)←→125°C(15min)	循环300次 300 cycles	22	0/22
常温寿命试验 Lifespan Test	JESD22-A108	Ta=25°C, If=50mA, Vcc=5V	1000h	22	0/22
高温寿命试验 DC Operating Life	JESD22-A108	Ta=110°C, If=20mA, Vcc=5V	1000h	76	0/76
高温高湿偏压 High Temperature High Humidity bias Voltage	JESD22-A101	Ta =85°C, RH=85% If=0mA, VCE=64V	1000h	22	0/22
高温偏压 High Temperature bias Voltage	JESD22-A108	Ta =110°C, If=0mA, VCE=80V	1000h	22	0/22
高压蒸汽试验 High pressure steam test	JESD22-A102	P=15PSIG, 121°C, 100%RH	96h	22	0/22

#### 失效判断标准 Criteria For Judging Damage

测试项目 Test Items	符号 Symbol	测试条件 Test Conditions	判定标准 Criteria For Judging Damage
正向电压 Forward Voltage	V <sub>F</sub> (V)	I <sub>F</sub> =20mA	初始值±20% Initial Data±20%
反向电流 Reverse Current	I <sub>R</sub> (uA)	V <sub>R</sub> =4V	I <sub>R</sub> ≤10μA
电流转换比 Current conversion ratio	CTR(%)	I <sub>F</sub> =5mA, V <sub>CE</sub> =5V	初始值±20% Initial Data±20%
集电极-发射极饱和电压 Collector-Emitter Saturation Voltage	V <sub>CE(sat)</sub>	I <sub>F</sub> =20mA, I <sub>C</sub> =1mA	V <sub>CE(sat)</sub> ≤0.2V
集电极-发射极击穿电压 Collector-Emitter breakdown voltage	BV <sub>CEO</sub> (V)	I <sub>C</sub> =0.1mA, I <sub>F</sub> =0mA	BV <sub>CEO</sub> ≥80V&初始值±20% BV <sub>CEO</sub> ≥80V& Initial Data±20%
集电极电流 Collector Current	I <sub>CEO</sub> (nA)	V <sub>CE</sub> =20V, I <sub>F</sub> =0	I <sub>CEO</sub> ≤0.1μA



## 八、产品包装 Packaging

### ◇ 包装管 Packaging Tube

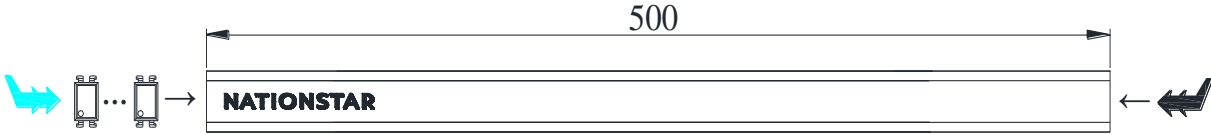

包装管长 500mm, 每条包装管装 100pcs 产品, 每管使用蓝白胶塞, 方向一致;

The packing tube is 500mm long, contains 100 units per tube, Blue and white plugs were used for each tube In the same direction;

### ◇ 内盒 Inner Box

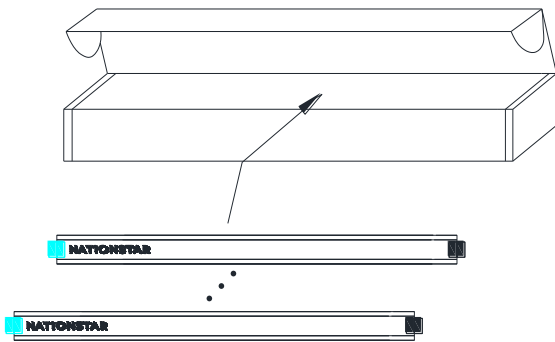

每个内盒装 50 条包装管,  
每盒装 5000pcs 产品;  
Each inner box contains 50  
packing tube,  
5000pcs product per box;

### ◇ 包装外箱 Cardboard Box

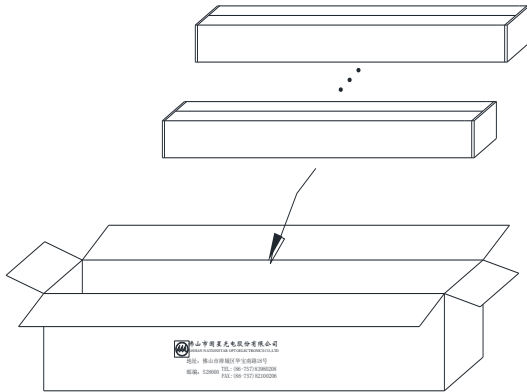

每个外箱装 8 个内盒,  
每箱共装 40000pcs 产品;  
Each outer box contains 8  
inner boxes,  
40000pcs product per box

### ◇ 标签说明 Label Explanation

TYPE: 产品型号

QTY: 数量 Quantity

BIN: 分档 Rank

SC: 分档表编号

LOT: 批号 Lot Number

IF: 测试电流 Testing Current

CTR: CTR 等级 CTR Rank

**光耦 817**

二维码  
Qr code

TYPE: FOC-817X-X-XX

QTY: XXXX                      IF(mA): XX

SC: XXX                              CTR: X

BIN: XXX

LOT: XXXXX                      QC: QC PASS

FOSHAN NATIONSTAR OPTOELECTRONICS CO., LTD  
佛山市国星光电股份有限公司

备注: 标签模板仅供参考, 请以实际参数为准!



## 九、使用注意事项 Precautions for Use

### ◇ 波峰焊接条件 Wave soldering Condition

建议在以下温度条件下进行一次性焊接:  
 One time soldering is recommended within the condition of temperature:  
 温度 Temperature:  $260 \pm 5 / -5 \text{ } ^\circ\text{C}$   
 时间 Time: 10 sec  
 预热温度 Preheat temperature: 25 to  $140 \text{ } ^\circ\text{C}$   
 预热时间 Preheat time: 30 to 80 sec

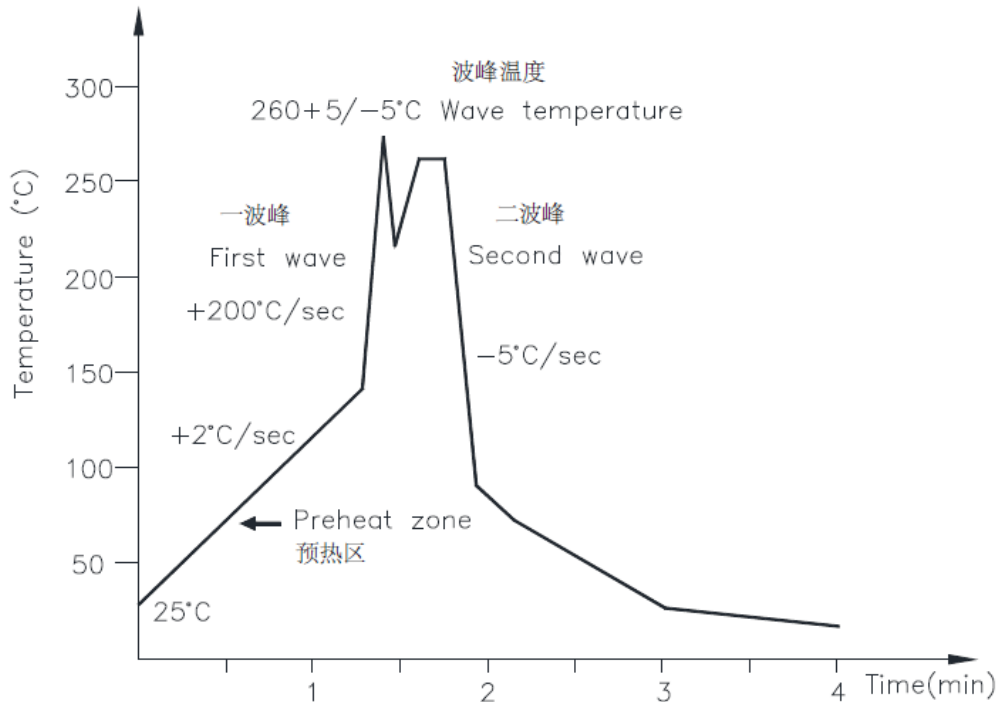

### ◇ 手工焊接条件 Hand soldering Condition

用电烙铁一次性手工性焊接条件:  
 Hand soldering by soldering iron, One time soldering is recommended:  
 温度 Temperature:  $380 \pm 5 / -5 \text{ } ^\circ\text{C}$   
 时间 Time: 3 sec max

## 十、免责声明 Precautions for Use

- 1、国星光电保留随时更改其产品和规格的权利，恕不另行通知；
- 1、Nationstar reserves the right to make changes to its products and specifications at any time without notice;
- 2、规格书中所示的图表仅表示典型数据，而非保证值；
- 2、The graphs shown in this datasheet are representing typical data only and do not show guaranteed values;
- 3、在最终设计、购买或使用之前，客户应获取并确认最新的产品信息和规格；
- 3、Customers should obtain and confirm the latest product information and specifications before final design, purchase or use;

