

Peltier-Type Chiller Thermo-con/ Rack Mount Type **Air-cooled**

New



Good space utilization

Mountable in a 19-inch rack

Saves space by mounting multiple equipment together in a rack.



Temperature stability $\pm 0.01^{\circ}\text{C}$ to 0.03°C

Set temperature range 10°C to 60°C

Cooling capacity 200 W

Power consumption **Energy saving** 440 W (100 V input, 4.6 A)

Space saving design with reduced height

Height dimension
Approx. **55% reduction**

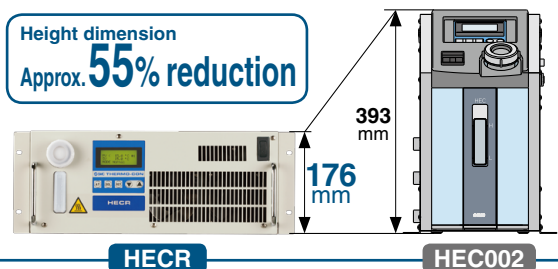

HECR

HEC002



Series **HECR**



CAT.ES40-61A

Can precisely control the temperature of a heat source or process fluid.

Precisely control the temperature of the circulating fluid by using the Peltier device.
 Refrigerant-free and environmentally friendly.



Radiating method Air-cooled **Cooling capacity** 200 W **Heating capacity** 600 W

Power supply Single-phase 100 to 240 VAC (Globally compatible power supplies)

Learning control function (Temperature control by external temperature sensor)

This function adjusts the fluid temperature to the set value with an automatic offset setting. Set the external temperature sensor at the circulating fluid inlet located just in front of the heat source, which allows the Thermo-con to sample the fluid temperature. This function is effective when automatically adjusting for heat exhaust from piping etc.

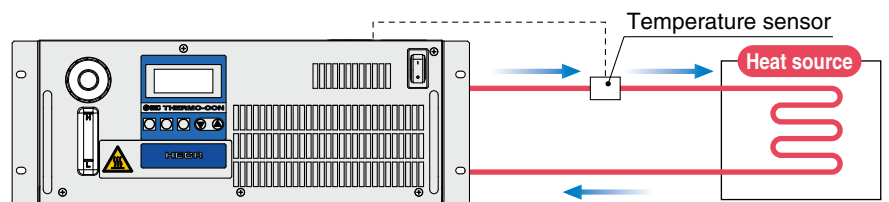

If the external temperature sensor is installed directly on the heat source, the learning control function may not work properly due to large heat volume or large temperature difference. Be sure to install the sensor at the circulating fluid inlet.

Simple operation

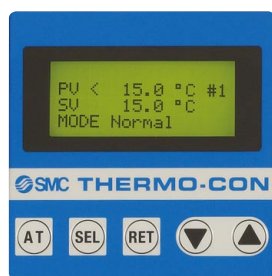

Fluid fill port
 Fluid can be supplied without removing the product from the rack.



Power switch

Drain pan

Drain pan is equipped to avoid any risk of fluid leakage over equipment mounted in a lower rack.

Circulating fluid volume can be checked.

- 1 Turn the power ON.
- 2 Press the **SEL** key, and adjust the temperature setting with the **▲**/**▼** keys.
- 3 Press the **RET** key to complete.

Rack mounting bracket

Floor type is also available. (Option)

The rack mounting brackets and the handles can be removed and rubber feet can be mounted instead. (Refer to page 11 for details.)

Low vibration, Low noise (49 dBA)

Less vibration and noise with no moving parts such as a compressor.

Volume ratio reduced by 36%

Better space utilization with reduced height and depth compared to the current model (HEC002).

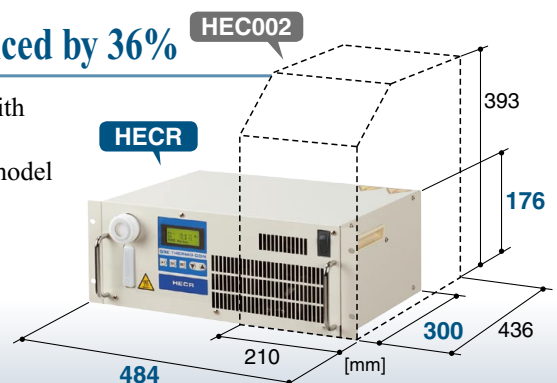

Construction and Principles

Figure 1

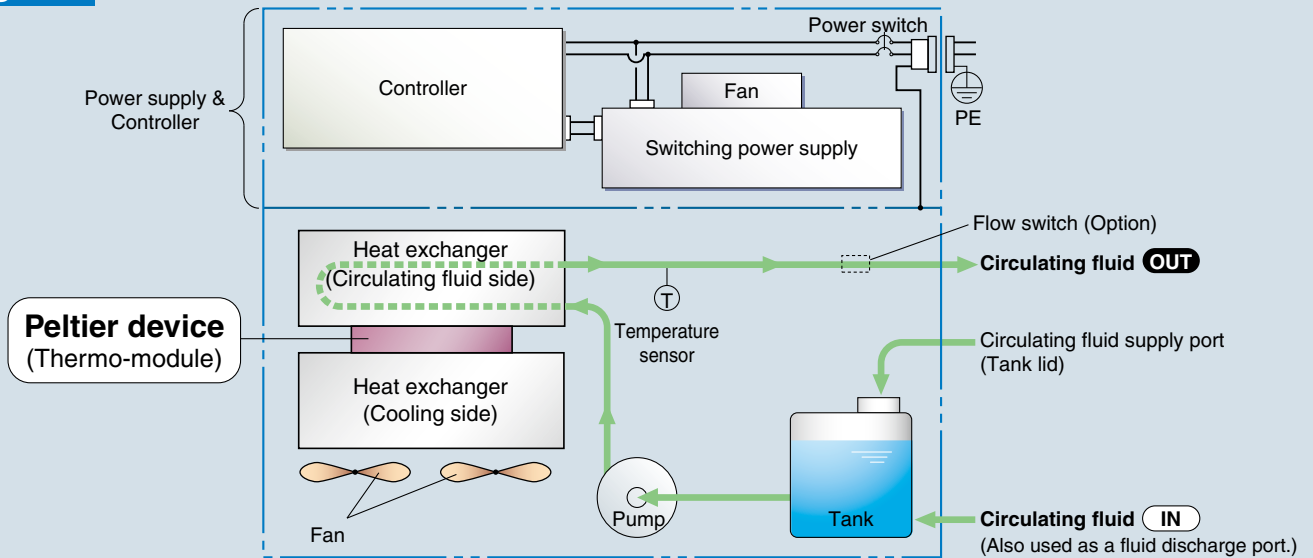

For the rack type, a flow switch (option) is mounted on the circulating fluid OUT side.

The Thermo-con is constructed as shown in Figure 1. It interposes a Peltier device (thermo-module) between the heat exchangers for the circulating fluid and facility water and controls the DC power supply to achieve the target outlet temperature of circulating fluid precisely.

The circulating fluid returns to the tank, and is transferred by the pump which is built in the Thermo-con, and goes through the heat exchangers and temperature sensor and out from the circulating fluid outlet.

Figure 2 shows an example of circulating fluid piping. The circulating fluid is transferred at a constant temperature by the pump.

Figure 2 Example of circulating fluid piping

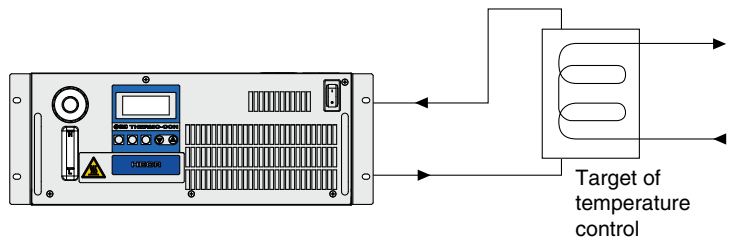

Principle of Peltier Device (Thermo-module)

A Peltier device (thermo-module) is a plate type element, inside which P-type semiconductors and N-type semiconductors are located alternately. If direct current is supplied to the Peltier device (thermo-module), heat is transferred inside the device, and one face generates heat and increases temperature while the other face absorbs heat and decreases temperature. Therefore, changing the direction of the current supplied to the Peltier device (thermo-module) can achieve heating and cooling operation. This method has a fast response and can shift quickly between heating and cooling, so temperature can be controlled very precisely.

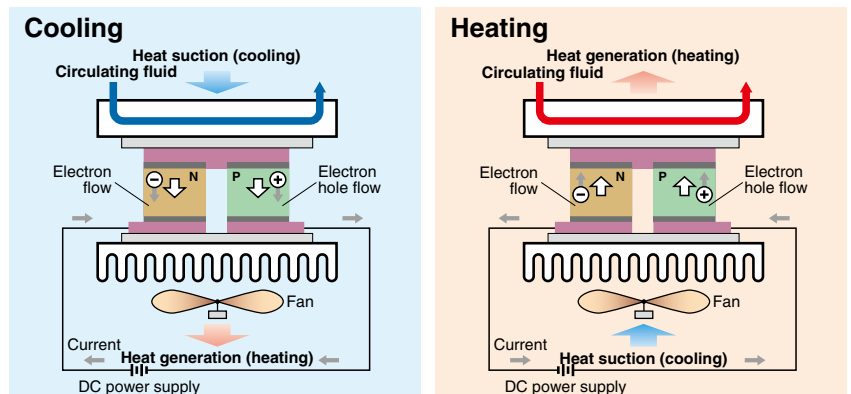

Application Examples

Laser machining

Cooling of laser irradiated part

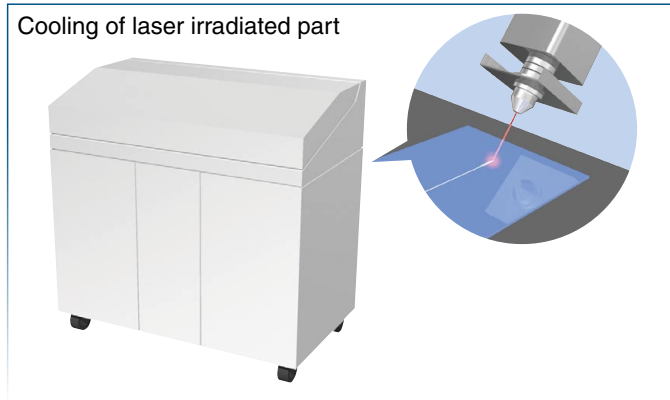

UV curing device (printing, painting, bonding and sealing)

Cooling of UV lamp

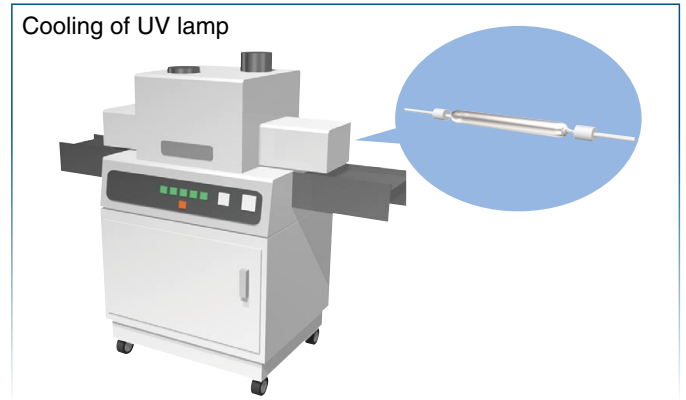

X-ray (digital) instrument

Temperature control of X-ray tube and
X-ray light sensing part

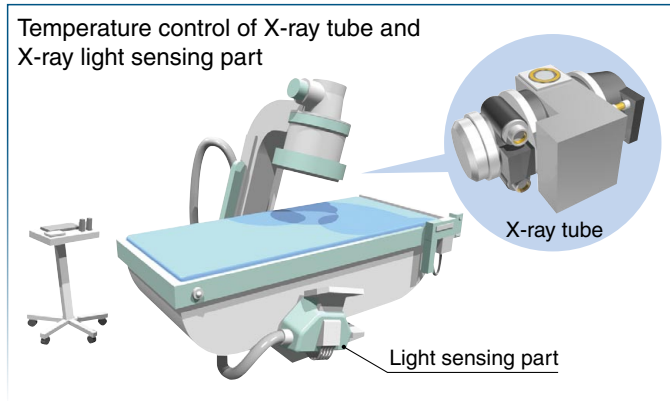

Electronic microscope

Temperature control
of electron-beam
irradiated part

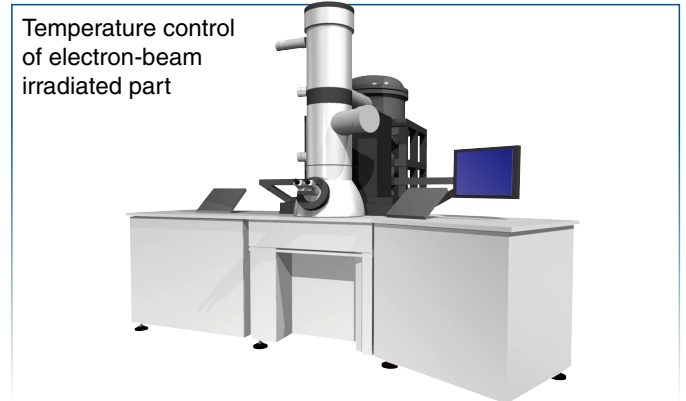

Laser marker

Cooling of laser irradiated part

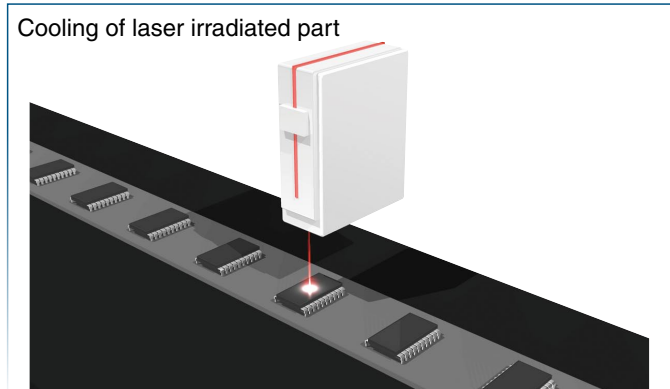

Ultra sonic wave inspection machine

Temperature
control of
ultrasonic wave
laser part

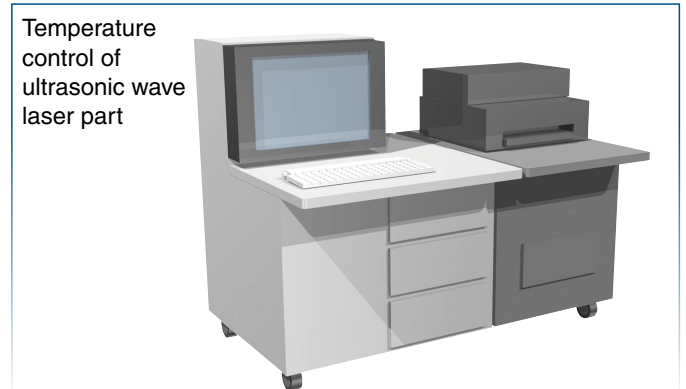

CONTENTS

Series *HECR*



● **Thermo-con/Rack Mount Type Series *HECR***

Model Selection	Page 5
How to Order/Specifications Air-cooled	Page 7
Cooling Capacity	Page 8
Heating Capacity	Page 8
Pump Capacity (Thermo-con Outlet)	Page 8
Dimensions	Page 9
Operation Display Panel	Page 10
Alarm	Page 10
Maintenance	Page 10

● **Options**

With Feet and No Rack Mounting Brackets	Page 11
With Flow Switch	Page 11

● **Optional Accessories**

Power Supply Cable	Page 12
--------------------------	---------

Specific Product Precautions	Page 13
------------------------------------	---------

Series *HECR* Model Selection

Guide to Model Selection

1. How much is the temperature in degrees centigrade for the circulating fluid?

Temperature range which can be set with the Thermo-con: 10 to 60°C

If a lower temperature (down to -20°C) or higher temperature (up to 90°C) than this range is necessary, select the Thermo-chiller HRZ series.

2. What kind of the circulating fluids will be used?

Circulating fluids that can be used in the Thermo-con: Water, Ethylene glycol 20%

When using fluorinated fluids, select the water-cooled Thermo-con HEC series.

3. How much cooling capacity required?

Allows a safety factor of 20% over the capacity that is actually required, taking into account the changes in the operating conditions. If a larger capacity than this Thermo-con is necessary, select the Peltier-type Thermo-con HEC series (refer to the following.) or the refrigerated Thermo-chiller HRS/HRZ series.

Example 1 When the heat generation amount in the user's equipment is known.

Heat generation amount: 400 W

Cooling capacity = Considering a safety factor of 20%,

$$400 \text{ W} \times 1.2 = 480 \text{ W}$$

Thermo-con/*Series HEC*

High-precision temperature control type for semiconductor manufacturing equipment, medical equipment, etc.

- Cooling capacity: 140 W to 1200 W
- Temperature stability: $\pm 0.01^\circ\text{C}$ to 0.03°C

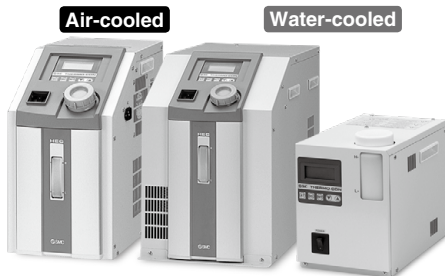

For details, refer to the **WEB catalog** or the Best Pneumatics No. 7.

Guide to Model Selection

Example 2 When the heat generation amount in the user's equipment is not known.

Obtain the temperature difference between inlet and outlet by circulating the fluid inside the user's equipment.

Heat generation amount **Q** : Unknown
 Circulating fluid temperature difference $\Delta T (= T_2 - T_1)$: 0.8°C (0.8 K)
 Circulating fluid outlet temperature **T1** : 25°C (298.15 K)
 Circulating fluid return temperature **T2** : 25.8°C (298.95 K)
 Circulating fluid flow rate **L** : 3 L/min
 Circulating fluid : Water
 Density γ : 1 x 10³ kg/m³
 Specific heat **C**: 4.2 x 10³ J/(kg·K)

$$Q = \frac{\Delta T \times L \times \gamma \times C}{60 \times 1000}$$

$$= \frac{0.8 \times 3 \times 1 \times 10^3 \times 4.2 \times 10^3}{60 \times 1000}$$

$$= 167 \text{ W}$$

Cooling capacity = Considering a safety factor of 20%,

$$167 \text{ W} \times 1.2 = \boxed{200 \text{ W}}$$

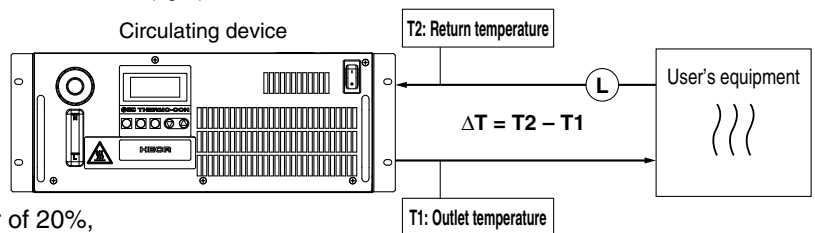

Example 3 When cooling the object below a certain temperature in certain period of time.

Cooled substance total volume **V** : 2 L
 Cooling time **h** : 15 min
 Cooling temperature difference ΔT : Temperature difference: 10°C (10 K). Cool from 30°C (303 K) to 20°C (293 K).
 Circulating fluid : Water
 Density γ : 1 x 10³ kg/m³
 Specific heat **C**: 4.2 x 10³ J/(kg·K)

* Refer to the information shown below for the typical physical property values by circulating fluid.

$$Q = \frac{\Delta T \times V \times \gamma \times C}{h \times 60 \times 1000}$$

$$= \frac{10 \times 2 \times 1 \times 10^3 \times 4.2 \times 10^3}{15 \times 60 \times 1000}$$

$$= 93.3 \text{ W}$$

Cooling capacity = Considering a safety factor of 20%,

$$93.3 \text{ W} \times 1.2 = \boxed{112 \text{ W}}$$

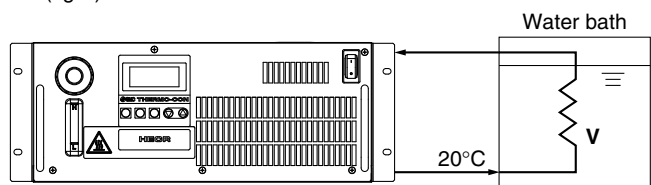

Precautions on Model Selection

The flow rate of the circulating fluid depends on the pressure loss of the user's equipment and the length, diameter and resistance created by bends in the circulating fluid piping etc. Check if the required flow rate of circulating fluid can be obtained before selecting.

Circulating Fluid Typical Physical Property Values

Ethylene Glycol Solution 20%

Temperature [°C]	Density ρ [kg/L]	Specific heat C [J/(kg·K)]
10	1.03	3.93 x 10 ³
20	1.03	3.95 x 10 ³
30	1.02	3.97 x 10 ³
40	1.02	3.98 x 10 ³
50	1.01	4.00 x 10 ³
60	1.01	4.02 x 10 ³

Water

Density γ : 1 x 10³ [kg/m³]

Specific heat **C**: 4.2 x 10³ [J/(kg·K)]

Thermo-con/ Rack Mount Type

Series **HECR** **Air-cooled**



How to Order

HECR 002 - A 5 [] - []

● **Cooling capacity**

002	200 W
-----	-------

● **Radiating method**

A	Air-cooled
---	------------

● **Power supply**

5	100 to 240 VAC
---	----------------

● **Option**

Nil	None
E	With feet and no rack mounting brackets
F	With flow switch

● **Pipe thread type**

Nil	Rc
N	NPT thread

Specifications

Model		HECR002-A
Cooling method		Thermoelectric device (Thermo-module)
Radiating method		Forced air cooling
Control method		Cooling/Heating automatic shift PID control
Ambient temperature/humidity		10 to 35°C, 35 to 80%RH (No condensation)
Circulating fluid system	Circulating fluid	Water, Ethylene glycol 20%
	Set temperature range	10.0 to 60.0°C (No condensation)
	Cooling capacity	200 W (Water) ^{Note 1)}
	Heating capacity	600 W (Water) ^{Note 1)}
	Temperature stability ^{Note 2)}	±0.01 to 0.03°C
	Pump capacity	Refer to the performance charts. (Page 8)
	Tank capacity	Approx. 1.3 L
Port size		Rc1/4
Wetted parts material		Stainless steel, EPDM, Ceramics, PPE, Carbon, PP, PE
Electrical system	Power supply	Single-phase 100 to 240 VAC ±10%, 50/60 Hz
	Overcurrent protector	10 A
	Current consumption	5 A (100 V) to 2.5 A (240 V)
	Power consumption	440 W ^{Note 1)}
	Alarm	Refer to "Alarm." (Page 10)
Communications		RS232C/RS-485
Weight		Approx. 14 kg
Accessories		Power supply connector, Operation Manual Power supply cable should be ordered as an option (sold separately) or prepared by the user.
Safety standards		CE marking, UL (NRTL) standards

Note 1) Conditions: Set temperature 25°C, Ambient temperature 25°C, Circulating flow rate 3 L/min

Note 2) The indicated values are with a stable load without turbulence in the operating conditions. It may be out of this range in some other operating conditions.

Cooling Capacity

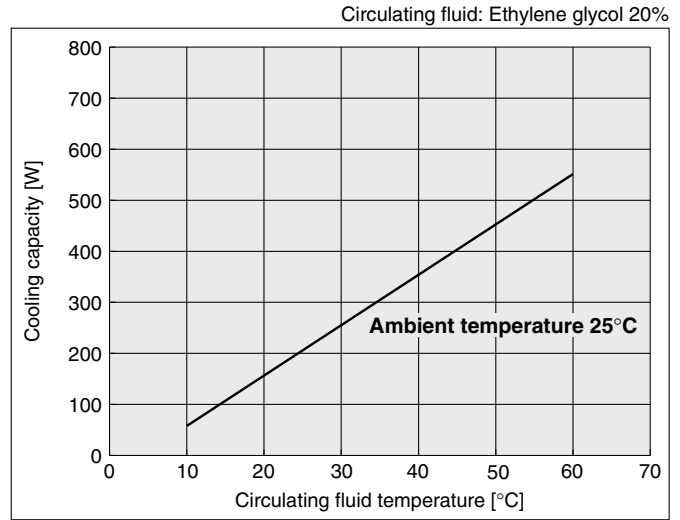
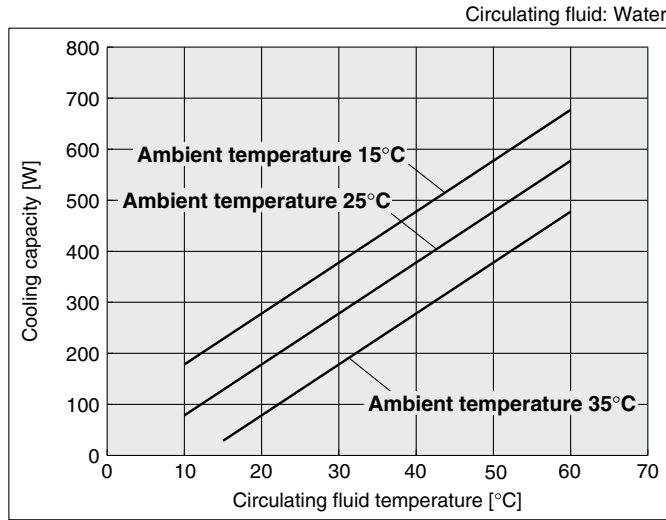

Heating Capacity

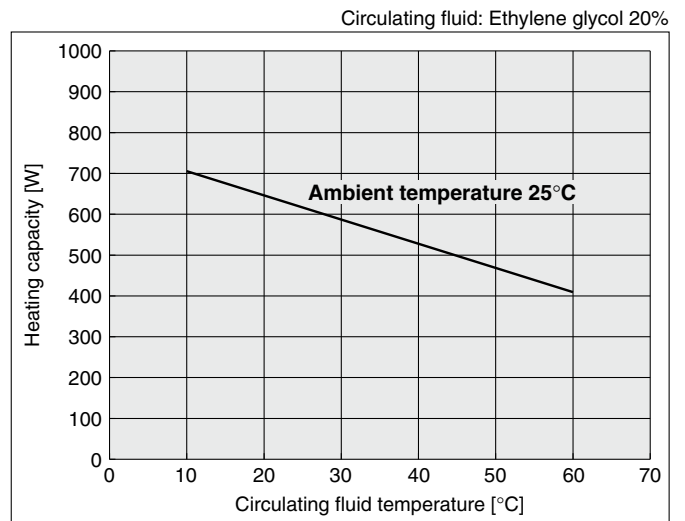
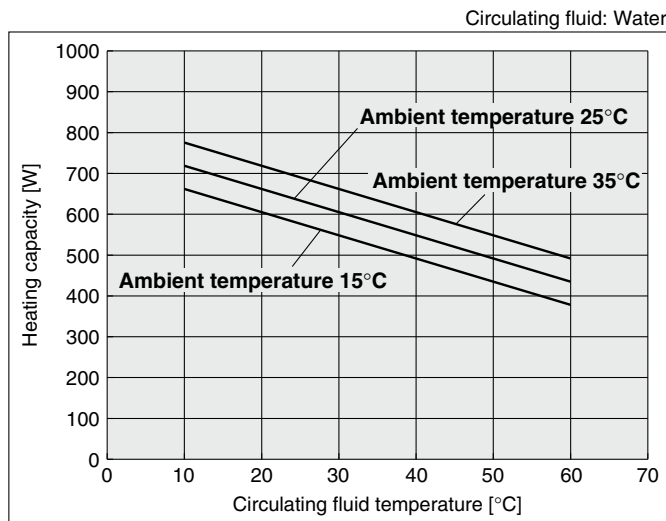

Pump Capacity (Thermo-con Outlet)

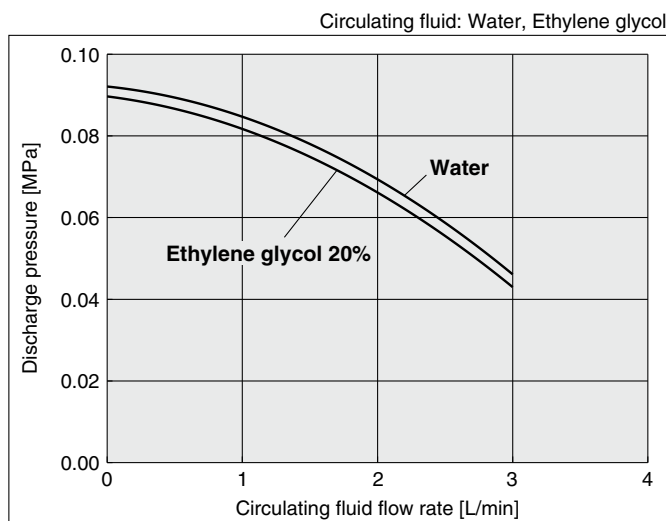

Series HECR

Dimensions

HECR002-A5

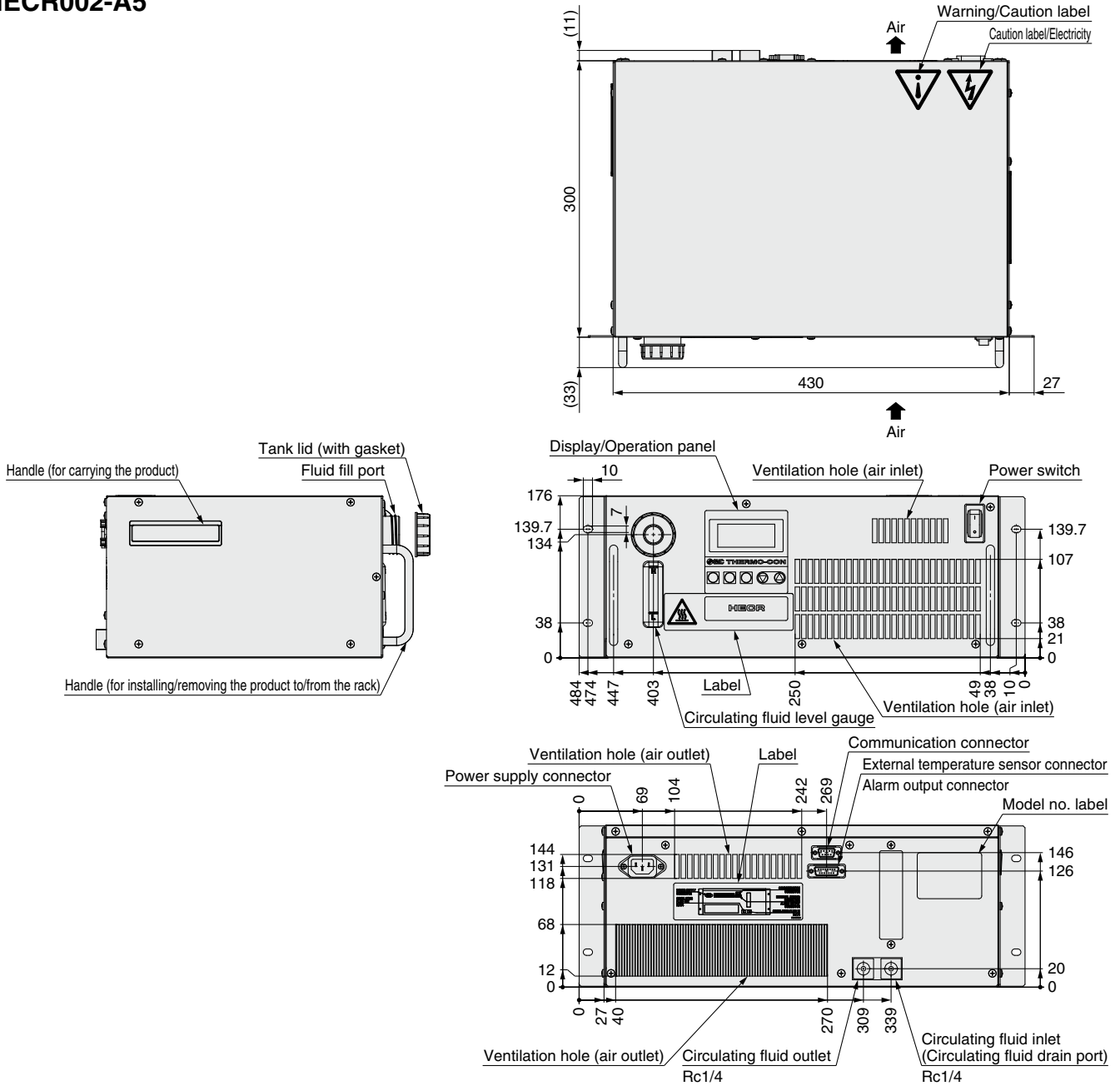

1. Power supply connector IEC60320 C14 (or equivalent)

Pin no.	Signal contents
N	100-240 VAC
L	100-240 VAC
E	PE

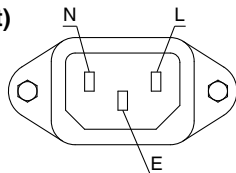

2. Communication connector D-sub 9 pin (socket) Holding screw: M2.6

Pin no.	Signal contents	
	RS-232C	RS-485
1	Unused	BUS+
2	RD	Unused
3	SD	Unused
4	Unused	Unused
5	SG	SG
6-8	Unused	Unused
9	Unused	BUS-

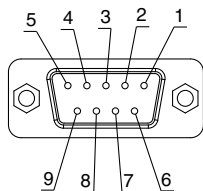

3. External temperature sensor connector/Alarm output connector D-sub 15 pin (socket) Holding screw: M2.6

Pin no.	Signal contents
1-2	Unused
3	Terminal A of resistance temperature detector
4	Terminal B of resistance temperature detector
5	Terminal B of resistance temperature detector
6	Contact a for output cutoff alarm (open when alarm occurs)
7	Common for output cutoff alarm
8	Contact b for output cutoff alarm (closed when alarm occurs)
9	Contact a for upper/lower temp. limit alarm (open when alarm occurs)
10	Common for upper/lower temp. limit alarm
11	Contact b for upper/lower temp. limit alarm (closed when alarm occurs)
12-14	Unused
15	FG

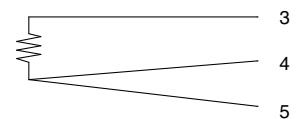
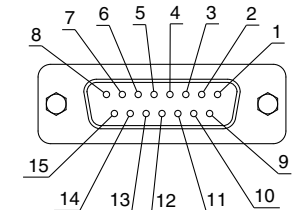

Connection diagram of resistance temperature sensor

Operation Display Panel

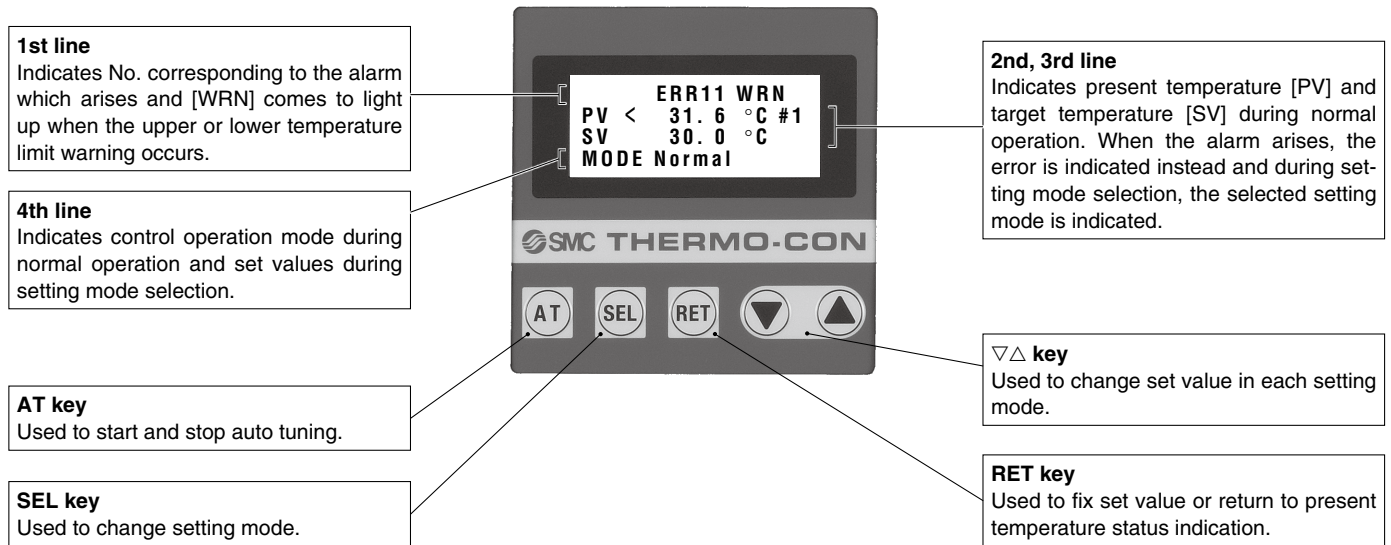

Alarm

This unit is equipped as standard with a function allowing 14 kinds of alarms to display on the LCD and can be read out by serial communication. Also, it can generate relay output for upper/lower temperature limit alarm and output cutoff alarm.

Alarm

Alarm code	Alarm description	Operation status	Main reason
WRN	Upper/Lower temp. limit alarm	Continue	The temperature has become out of upper/lower limit range for the target temperature.
ERR01	System error 1	Stop	The internal cable of the Thermo-con has been broken due to abnormal vibration or dropping the product.
ERR02	System error 2	Stop	EEPROM data has been lost due to high level noise.
ERR03	Back-up data error	Stop	EEPROM data of the controller has been destroyed due to high level noise.
ERR11	DC power supply failure	Stop	The DC power supply has failed (due to fan stop or abnormal high temperature) or the thermo-module has been short-circuited.
ERR12	Internal temp. sensor high temp. error	Stop	The internal temperature sensor has become higher than high temp. cutoff setting.
ERR13	Internal temp. sensor low temp. error	Stop	The internal temperature sensor has become lower than low temp. cutoff setting.
ERR14	Thermostat alarm	Stop	The thermostat has been activated due to filter clog or fan/pump failure, etc.
ERR15	Abnormal output alarm	Continue	The temperature cannot be changed even at 100% output due to overload or disconnection of the thermo-module.
ERR16	Low flow rate alarm (Option)	Stop	The flow rate of the circulating fluid has dropped.
ERR17	Internal temp. sensor disconnection alarm	Stop	The internal temperature sensor has been disconnected or short-circuited.
ERR18	External temp. sensor disconnection alarm	Continue	The external temperature sensor has been disconnected or short-circuited. (Only detected when in learning control or external tune control)
ERR19	Abnormal auto tuning alarm	Stop	Auto tuning has not been completed within 20 minutes.
ERR20	Low fluid level alarm	Stop	The amount of circulating fluid in the tank has dropped.

Maintenance

Maintenance of this unit is performed only in the form of return to and repair at SMC's site. As a rule, SMC will not conduct on-site maintenance.

Series *HECR* Options

Note) Options have to be selected when ordering the Thermo-con.
It is not possible to add them after purchasing the unit.

E Option symbol With Feet and No Rack Mounting Brackets

HECR002-A5□-E

• With feet and no rack mounting brackets

Rack mounting brackets and handles on the front side are removed as they are not necessary when the product is not mounted in a rack. This option has rubber feet for installing the product on the floor.

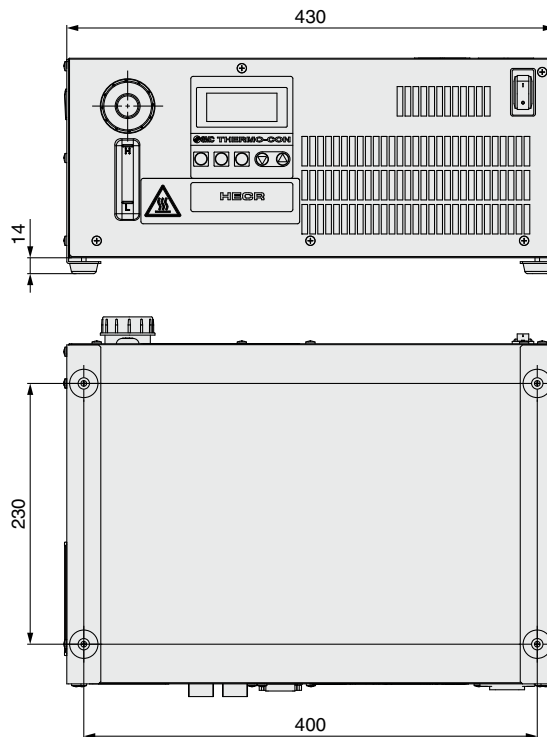

F Option symbol With Flow Switch

HECR002-A5□-F

• With flow switch

This is an ON/OFF switch detecting low levels of the circulating fluid. When the fluid volume is 1 L/min or less, "ERR16" is displayed and the Thermo-con stops. The flow switch is built into the Thermo-con. Refer to page 2.

Applicable model

HECR002-A5□-F

Series HECR Optional Accessories

① Power Supply Cable

■ For single-phase 100/115 VAC type

* Not applicable for the 200 V type.

Part no.	Applicable model
HRS-CA001	HECR002

* Not applicable to the retaining clip.

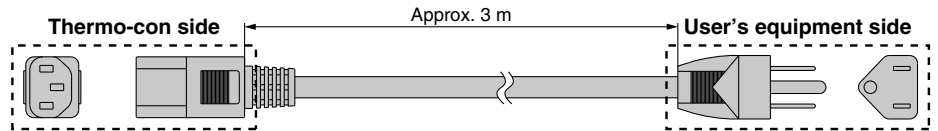

Part no.	Applicable model
HRS-CA003	HECR002

* Applicable to the retaining clip.

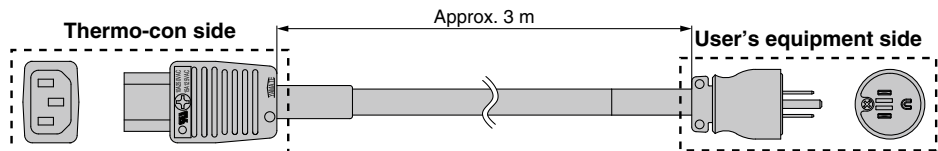

■ For single-phase 200 VAC type

* Also applicable for the 100 VAC type, but the connector for the user's equipment needs to be prepared by the user.

Part no.	Applicable model
HRS-CA002	HECR002

* Applicable to the retaining clip.

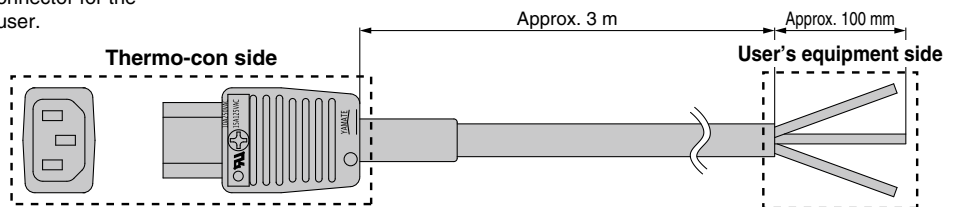

■ Retaining clip

Holds the connector on the Thermo-con side in position.

Part no.	Applicable power supply cable model
HRS-S0074	HRS-CA002
	HRS-CA003
	Power supply connector for accessory

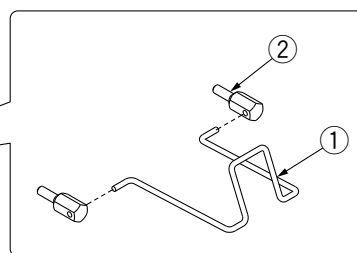
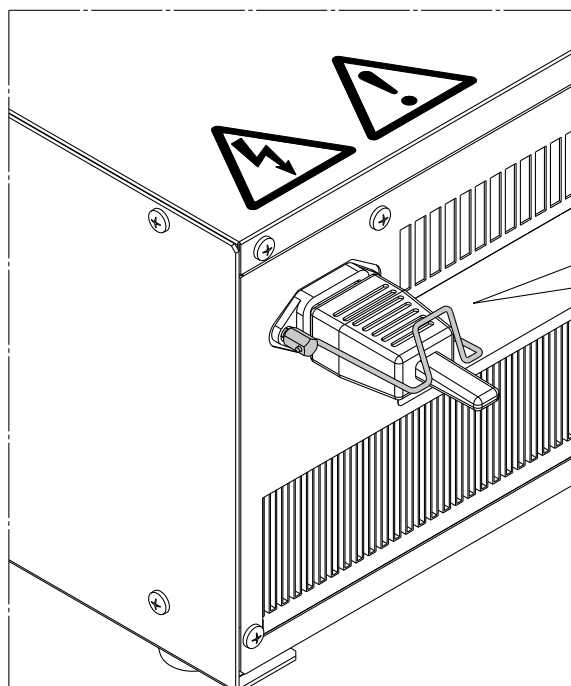

Parts List

No.	Description
①	Retaining clip
②	Holding screw



Series **HECR**

Specific Product Precautions 1

Be sure to read this before handling. Refer to the back cover for Safety Instructions. For Temperature Control Equipment Precautions, refer to “Handling Precautions for SMC Products” and the Operation Manual on SMC website, <http://www.smcworld.com>

System Design

Warning

- 1. This catalog shows the specifications of the Thermo-con.**
 1. Check the detailed specifications in the separate “Product Specifications”, and evaluate the compatibility of the Thermo-con with user’s system.
 2. Although the protection circuit as a single unit is installed, the user is requested to carry out the safety design for the whole system.

Handling

Warning

- 1. Thoroughly read the Operation Manual.**

Read the Operation Manual completely before operation, and keep this manual available whenever necessary.
- 2. If the set temperature is repeatedly changed by 10°C or more, the Thermo-con may fail in short periods of time.**

Operating Environment/Storage Environment

Warning

- 1. Keep within the specified ambient temperature and humidity range.**

Also, if the set temperature is too low, condensation may form on the inside of the Thermo-con or the surface of piping even within the specified ambient temperature range. Dew condensation can cause failure, and so must be avoided by considering operating conditions.
- 2. The Thermo-con is not designed for clean room usage.**

The pump and fan generate dust.
- 3. Low molecular siloxane can damage the contact of the relay.**

Use the Thermo-con in a place free from low molecular siloxane.

Transportation/Movement/Installation

Caution

- 1. Avoid strong vibration and/or impact.**

The product is precision equipment. Do not apply vibration or impact during transportation.
- 2. Caution when moving a heavy object.**

This product is heavy. Use adequate caution to avoid injury when picking up and setting down the product, and dropping accidents should be avoided.
- 3. Installation**

When installing the product into a rack, it should be designed that the product weight is held with the bottom surface of the product. Use the handles on the front side of the product when installing/removing the product to/from the rack.

Radiation Air

Caution

- 1. The inlet for radiation air must not be exposed to particles and dust as far as possible.**
- 2. Do not let the inlet and outlet for radiation air get closed.**
- 3. If more than one Thermo-con is used, consider their arrangement so that the downstream sides of the Thermo-cons suck radiation air from the upstream sides.**

Otherwise, the performance at the downstream sides may deteriorate. Also, the set temperature may not be achieved depending on the value of the set temperature and the load. In such a case, take countermeasures such as changing the direction of the Thermo-cons to prevent the deterioration of performance.
- 4. Filters are not built-in. Mount them as necessary.**
- 5. Flow rate of the heat dissipation air is approximately 2 m³/min. The heat generation is approximately 600 W at maximum.**

Circulating Fluid

Caution

- 1. Use a fluid that is listed in the specifications.**
- 2. Deionized water (with an electrical conductivity of approximately 1 μS/cm) can be used, but may lose its electrical conductivity.**

Also, if a facility supplying deionized water is used, the Thermo-con may be damaged by static electricity.
- 3. If deionized water is used, bacteria and algae may grow in a short period.**

If the Thermo-con is operated with bacteria and algae, its cooling capacity or the capacity of the pump may deteriorate. Exchange all deionized water regularly depending on the conditions (once a month as a guide).
- 4. If using a fluid other than those listed in the specifications, please contact SMC beforehand.**
- 5. The maximum operating pressure of circulating fluid circuit is 0.1 MPa.**

If this pressure is exceeded, leakage from the tank in the Thermo-con can result.
- 6. Select a pipe with a length and diameter which allow a flow rate of 0.5 L/min or more for the circulating fluid.**

If the flow rate is less than 0.5 L/min, the Thermo-con cannot provide precise control, but also can fail because of the repeated cooling and heating operation.
- 7. A magnet driven pump is used as a circulating pump.**

A fluid which contains metal powders such as iron powder cannot be used.



Series HE CR

Specific Product Precautions 2

Be sure to read this before handling. Refer to the back cover for Safety Instructions. For Temperature Control Equipment Precautions, refer to “Handling Precautions for SMC Products” and the Operation Manual on SMC website, <http://www.smcworld.com>

Circulating Fluid

⚠ Caution

8. The Thermo-con must not be operated without circulating fluid.

The pump can break due to idling.

9. If the tank lid is opened after the supply of circulating fluid, the circulating fluid may spill out depending on the condition of external piping.

10. If an external tank is used, the circulating fluid may spill out from the internal tank lid depending on where the external tank is installed.

Confirm that the internal tank has no leakage if using an external tank.

11. If there is a point where fluid is released to atmosphere externally (tank or piping), minimize the piping resistance at the circulating fluid return side.

If the piping resistance is too large, the piping may be crushed, or the built-in circulator tank may be deformed or cracked because the pressure in the piping for return will become negative. The built-in circulator tank is made of resin (PE). Therefore, the tank may be crushed if the pressure is negative. Special attention must be paid if the flow rate of the circulating fluid is high. To avoid getting negative pressure -0.02 MPa or less, the piping for return should be as thick and short as possible to minimize the piping resistance. It is also effective to restrict the flow rate of circulating fluid or remove the gasket of internal tank for the release to atmosphere.

12. Fluorinated fluid is outside of the specifications.

If it is used in the Thermo-con, static electricity will be generated by the flow of fluid. This static electricity may be discharged to the board of the Thermo-con, causing damage or operation failure and loss of data of such as set temperature.

Also, as the specific gravity of the fluorinated fluid is 1.5 to 1.8 times of water, the pump will be overloaded, which also causes fluorinated fluid to be outside the specifications. Therefore, if fluorinated fluid is used, please contact SMC and we will introduce a suitable special product (water-cooled type).

13. Avoid operation with cavitation or bubbles due to low fluid level in the tank. This may shorten the pump life.

Circulating Fluid

⚠ Caution

14. If water is used, it should satisfy the quality standards shown below.

Water (as Circulating Fluid) Quality Standards

The Japan Refrigeration and Air Conditioning Industry Association
JRA GL-02-1994 “Cooling water system – Circulating type – Make-up water”

	Item	Unit	Standard value	Influence	
				Corrosion	Scale generation
Standard item	pH (at 25°C)	—	6.0 to 8.0	○	○
	Electrical conductivity (25°C)	[μS/cm]	100* to 300*	○	○
	Chloride ion (Cl ⁻)	[mg/L]	50 or less	○	
	Sulfuric acid ion (SO ₄ ²⁻)	[mg/L]	50 or less	○	
	Acid consumption amount (at pH4.8)	[mg/L]	50 or less		○
	Total hardness	[mg/L]	70 or less		○
	Calcium hardness (CaCO ₃)	[mg/L]	50 or less		○
Reference item	Ionic state silica (SiO ₂)	[mg/L]	30 or less		○
	Iron (Fe)	[mg/L]	0.3 or less	○	○
	Copper (Cu)	[mg/L]	0.1 or less	○	
	Sulfide ion (S ₂ ⁻)	[mg/L]	Should not be detected.	○	
	Ammonium ion (NH ₄ ⁺)	[mg/L]	0.1 or less	○	
	Residual chlorine (Cl)	[mg/L]	0.3 or less	○	
	Free carbon (CO ₂)	[mg/L]	4.0 or less	○	

* In the case of [MΩ·cm], it will be 0.003 to 0.01.

○: Factors that have an effect on corrosion or scale generation.

• Even if the water quality standards are met, complete prevention of corrosion is not guaranteed.

15. The tank capacity is approximately 1 liter at the High level, and approximately 0.4 liters at the Low level. When the fluid level goes below the Low level, “ERR20” (Low fluid level alarm) will be generated.

Maintenance

⚠ Warning

1. Prevention of electric shock and fire

Do not operate the switch with wet hands. Also, do not operate the Thermo-con with water left on it.

2. Action in the case of error

If any error such as abnormal sounds, smoke, or bad smell occurs, cut off the power at once, and stop supplying and conveying fluid. Please contact SMC or a sales distributor to repair the Thermo-con.

3. Regular inspection

Check the following items at least once a month. The inspection must be done by an operator who has sufficient knowledge and experience.

- Check of displayed contents.
- Check of temperature, vibration and abnormal sounds in the body of the Thermo-con.
- Check of the voltage and current of the power supply system.
- Check for leakage and contamination of the circulating fluid and intrusion of foreign objects to it, and subsequent replacement of fluid.
- Check for flow condition and temperature of radiation air.

Safety Instructions

These safety instructions are intended to prevent hazardous situations and/or equipment damage. These instructions indicate the level of potential hazard with the labels of “**Caution**,” “**Warning**” or “**Danger**.” They are all important notes for safety and must be followed in addition to International Standards (ISO/IEC)*1), and other safety regulations.

 **Caution:** **Caution** indicates a hazard with a low level of risk which, if not avoided, could result in minor or moderate injury.

 **Warning:** **Warning** indicates a hazard with a medium level of risk which, if not avoided, could result in death or serious injury.

 **Danger:** **Danger** indicates a hazard with a high level of risk which, if not avoided, will result in death or serious injury.

*1) ISO 4414: Pneumatic fluid power – General rules relating to systems.
ISO 4413: Hydraulic fluid power – General rules relating to systems.
IEC 60204-1: Safety of machinery – Electrical equipment of machines.
(Part 1: General requirements)
ISO 10218-1: Manipulating industrial robots – Safety.
etc.

Warning

1. The compatibility of the product is the responsibility of the person who designs the equipment or decides its specifications.

Since the product specified here is used under various operating conditions, its compatibility with specific equipment must be decided by the person who designs the equipment or decides its specifications based on necessary analysis and test results. The expected performance and safety assurance of the equipment will be the responsibility of the person who has determined its compatibility with the product. This person should also continuously review all specifications of the product referring to its latest catalog information, with a view to giving due consideration to any possibility of equipment failure when configuring the equipment.

2. Only personnel with appropriate training should operate machinery and equipment.

The product specified here may become unsafe if handled incorrectly. The assembly, operation and maintenance of machines or equipment including our products must be performed by an operator who is appropriately trained and experienced.

3. Do not service or attempt to remove product and machinery/equipment until safety is confirmed.

1. The inspection and maintenance of machinery/equipment should only be performed after measures to prevent falling or runaway of the driven objects have been confirmed.
2. When the product is to be removed, confirm that the safety measures as mentioned above are implemented and the power from any appropriate source is cut, and read and understand the specific product precautions of all relevant products carefully.
3. Before machinery/equipment is restarted, take measures to prevent unexpected operation and malfunction.

4. Contact SMC beforehand and take special consideration of safety measures if the product is to be used in any of the following conditions.

1. Conditions and environments outside of the given specifications, or use outdoors or in a place exposed to direct sunlight.
2. Installation on equipment in conjunction with atomic energy, railways, air navigation, space, shipping, vehicles, military, medical treatment, combustion and recreation, or equipment in contact with food and beverages, emergency stop circuits, clutch and brake circuits in press applications, safety equipment or other applications unsuitable for the standard specifications described in the product catalog.
3. An application which could have negative effects on people, property, or animals requiring special safety analysis.
4. Use in an interlock circuit, which requires the provision of double interlock for possible failure by using a mechanical protective function, and periodical checks to confirm proper operation.

Caution

1. The product is provided for use in manufacturing industries.

The product herein described is basically provided for peaceful use in manufacturing industries.
If considering using the product in other industries, consult SMC beforehand and exchange specifications or a contract if necessary.
If anything is unclear, contact your nearest sales branch.

Limited warranty and Disclaimer/ Compliance Requirements

The product used is subject to the following “Limited warranty and Disclaimer” and “Compliance Requirements”.

Read and accept them before using the product.

Limited warranty and Disclaimer

1. The warranty period of the product is 1 year in service or 1.5 years after the product is delivered, whichever is first.*2)
Also, the product may have specified durability, running distance or replacement parts. Please consult your nearest sales branch.
2. For any failure or damage reported within the warranty period which is clearly our responsibility, a replacement product or necessary parts will be provided.
This limited warranty applies only to our product independently, and not to any other damage incurred due to the failure of the product.
3. Prior to using SMC products, please read and understand the warranty terms and disclaimers noted in the specified catalog for the particular products.

*2) Vacuum pads are excluded from this 1 year warranty.

A vacuum pad is a consumable part, so it is warranted for a year after it is delivered.
Also, even within the warranty period, the wear of a product due to the use of the vacuum pad or failure due to the deterioration of rubber material are not covered by the limited warranty.

Compliance Requirements

1. The use of SMC products with production equipment for the manufacture of weapons of mass destruction (WMD) or any other weapon is strictly prohibited.
2. The exports of SMC products or technology from one country to another are governed by the relevant security laws and regulations of the countries involved in the transaction. Prior to the shipment of a SMC product to another country, assure that all local rules governing that export are known and followed.

Caution

SMC products are not intended for use as instruments for legal metrology.

Measurement instruments that SMC manufactures or sells have not been qualified by type approval tests relevant to the metrology (measurement) laws of each country. Therefore, SMC products cannot be used for business or certification ordained by the metrology (measurement) laws of each country.

 **Safety Instructions** Be sure to read “Handling Precautions for SMC Products” (M-E03-3) before using.