

SERIES 100 SWITCHES

TOGGLE SWITCHES - MINIATURE

US



SPECIFICATIONS

Contact Rating:	See contact material options
Life Expectancy:	40,000 make-and-break cycles
Contact Resistance:	10 mΩ max. typical initial @ 2-4 VDC 100 mA for both silver and gold plated contacts
Insulation Resistance:	1,000 MΩ min.
Dielectric Strength:	1,000 V RMS @ sea level
Operating Temperature:	-30° C to 85° C

MATERIALS

Case:	Diallyl Phthalate (DAP)
Toggle Handle:	Brass, chrome plated
Switch Support:	Brass or steel, tin plated
Bushing:	Brass, nickel plated
Housing:	Stainless steel
Contacts / Terminals:	Silver or gold plated copper alloy

FEATURES & BENEFITS

- ▶ Up to 4 poles available
- ▶ Variety of switching functions
- ▶ Miniature
- ▶ Multiple actuator & bushing options

APPLICATIONS/MARKETS

- ▶ Telecommunications
- ▶ Instrumentation
- ▶ Networking
- ▶ Medical equipment

HOW TO ORDER

SERIES 100	MODEL NO.	ACTUATOR	BUSHING	TERMINATION	CONTACT MATERIAL	SEAL E	HARDWARE
	SP1	T1†	B1	M1	Q = Silver R = Gold	E = Epoxy Sealed at Base of Terminal	H = Hardware
	SP2*	T2	B2	M2			
	SP3	T3	B3	M3			
	SP4*	T4	B4	M5			
	SP5*	T5	B5	M6			
	DP1	T6	B6	M61			
	DP2*	T7	B8	M7			
	DP3	T8	B9	M71			
	DP4*	T9	B11	VS2			
	DP5*	K1	B12	VS3			
	DP6	K2	B13	VS5*			
	DP7*		B15	M64*			
	DP8*	† Optional Toggle Cap (T1 Only): T100-1 = White T100-2 = Black	B16	VS21*			
	3P1		B25**	VS31*			
	3P2*		B26**				
	3P3						
	3P4*						
	3P5*						
	4P1						
	4P2*						
	4P3						
	4P4*						
	4P5*						
	4P6						
	4P7*						
	4P8*						

▶ ▶ ▶ Example Ordering Number
100-SP1-T4-B2-M1-R-E

Notes: * Not available with the K1 and K2 actuator options.

** Available only with the K1 and K2 actuator options.

Specifications subject to change without notice.



SPDT



SCHEMATIC



Model No.	POS 1	POS 2	POS 3
SP-1	ON	NONE	ON
SP-2	ON	NONE	(ON)
SP-3	ON	OFF	ON
SP-4	(ON)	OFF	(ON)
SP-5	ON	OFF	(ON)
Term. Comm.	2-3	OPEN	2-1

() = Momentary

DPDT



SCHEMATIC



Model No.	POS 1	POS 2	POS 3
DP-1	ON	NONE	ON
DP-2	ON	NONE	(ON)
DP-3	ON	OFF	ON
DP-4	(ON)	OFF	(ON)
DP-5	ON	OFF	(ON)
DP-7	ON	ON	(ON)
DP-8	(ON)	ON	(ON)
Term. Comm.	2-3, 5-6	OPEN	2-1, 5-4

DP-6	ON	ON	ON
Term. Comm.	2-3, 5-6	2-3, 5-4	2-1, 5-4

() = Momentary

3PDT



SCHEMATIC



Model No.	POS 1	POS 2	POS 3
3P-1	ON	NONE	ON
3P-2	ON	NONE	(ON)
3P-3	ON	OFF	ON
3P-4	(ON)	OFF	(ON)
3P-5	ON	OFF	(ON)
Term. Comm.	2-3, 5-6 8-9	OPEN	2-1, 5-4 8-7

() = Momentary

4PDT



SCHEMATIC



Model No.	POS 1	POS 2	POS 3
4P-1	ON	NONE	ON
4P-2	ON	NONE	(ON)
4P-3	ON	OFF	ON
4P-4	(ON)	OFF	(ON)
4P-5	ON	OFF	(ON)
4P-7	ON	ON	(ON)
4P-8	(ON)	ON	(ON)
Term. Comm.	2-3, 5-6 8-9 11-12	OPEN	2-1, 5-4 8-7 11-10

4P-6	ON	ON	ON
Term. Comm.	2-3, 5-6 8-9 11-12	2-3, 5-4 8-9 11-10	2-1, 5-4 8-7 11-10

() = Momentary

SERIES 100 SWITCHES

TOGGLE SWITCHES - MINIATURE

3 - WAY WIRING DIAGRAM SCHEMATICS



ACTUATOR OPTIONS

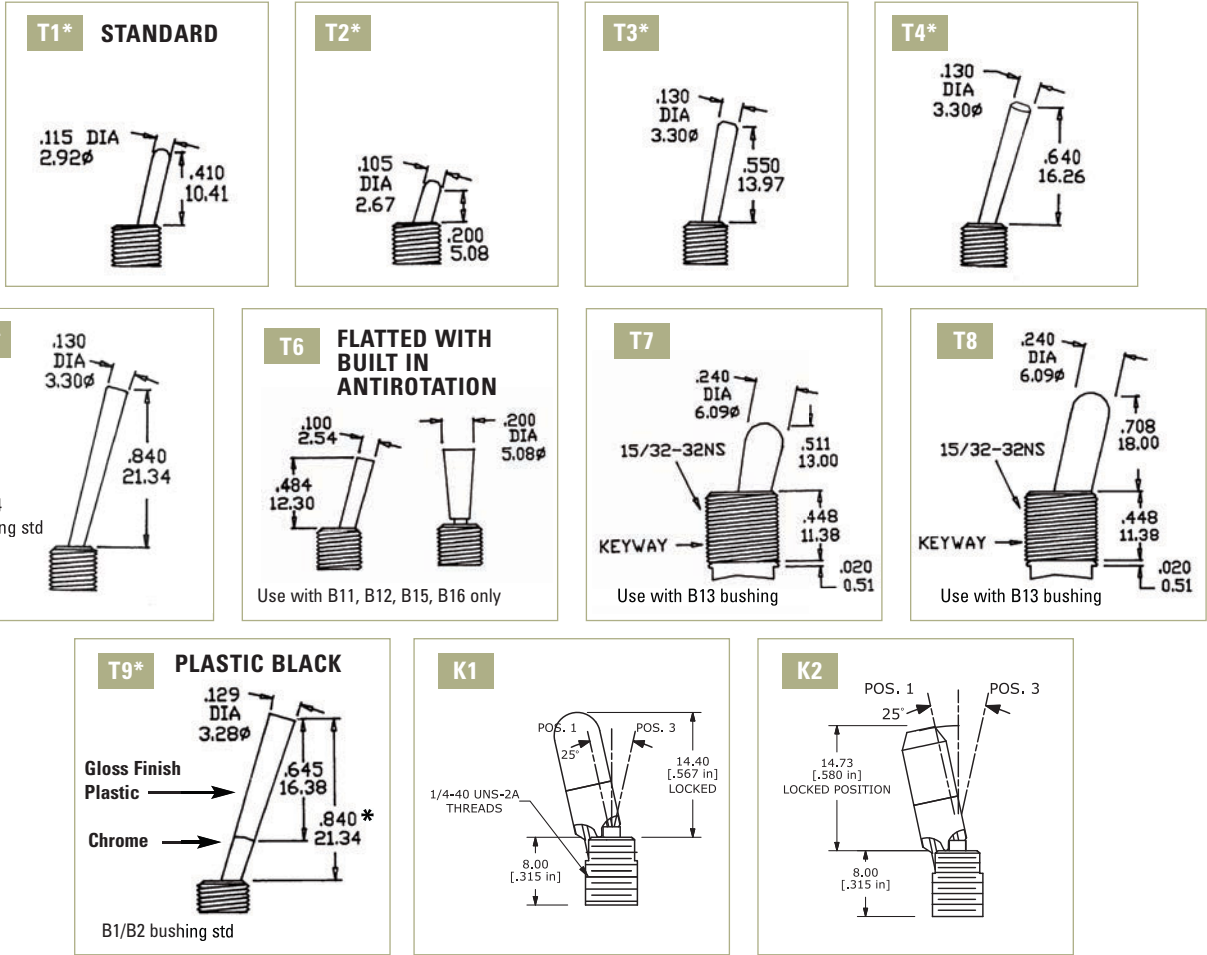

*Add .070 (1.78) for B3, B4 bushings, subtract .020 (0.51) for B6 bushing.



BUSHING OPTIONS

B1 THD STD

B2 NON-THD



B3 THD STD

B4 NON-THD



B4 is standard for M6, M7 and VS termination options.

B5 HIGH TORQUE



B6 HIGH TORQUE



B8 METRIC THD



B9 SPLASH PROOF



B13



Use with T7 and T8 actuators only

B11 THD STD

B12 NON-THD

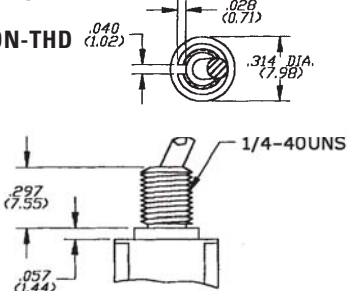

Use with T6 actuator only

B15 THD STD

B16 NON-THD



Use with T6 actuator only

B25



B26



SERIES 100 SWITCHES

TOGGLE SWITCHES - MINIATURE

BUSHING OPTIONS - PANEL MOUNTING



TERMINATION OPTIONS

M2

SPDT



M1

SOLDER LUG



M3

QUICK CONNECT



M2

DPDT

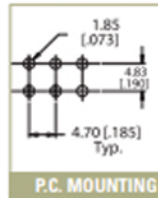

M5

WIRE WRAP

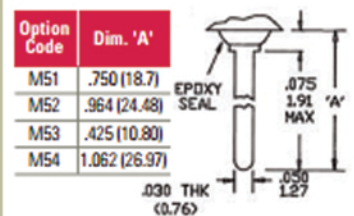

M6

SPDT





M6

DPDT

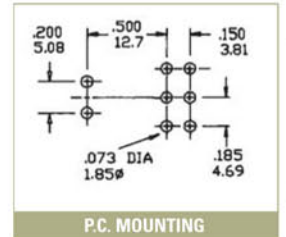

M7

SPDT

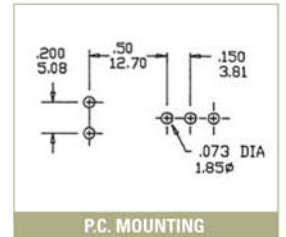

M7

DPDT

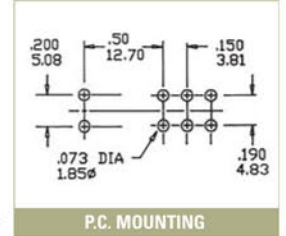

M7

3PDT

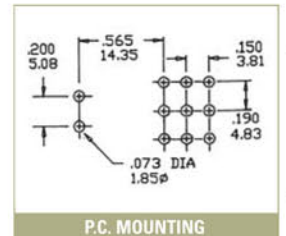

M7

4PDT

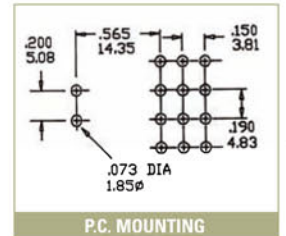

SERIES 100 SWITCHES

TOGGLE SWITCHES - MINIATURE

TACT
SWITCHES

NAVIGATION
SWITCHES

PUSHBUTTON
SWITCHES

TOGGLE
SWITCHES

ROCKER
SWITCHES

SLIDE
SWITCHES

SNAP-ACTION
SWITCHES

DIP
SWITCHES

KEYLOCK
SWITCHES

ROTARY
SWITCHES

DETECTOR
SWITCHES

CAP
OPTIONS

VS2-VS3

SPDT



Option Code	Dim. 'A'
VS2	.460 (11.68)
VS3	.630 (16.00)



VS2-VS3

DPDT



Option Code	Dim. 'A'
VS2	.460 (11.68)
VS3	.630 (16.00)



VS5

DPDT



Option Code	Dim. 'A'
VS5	.630 (16.00)



M61

SPDT





M61

DPDT



M71

SPDT



M64

SPDT



TACT SWITCHES
 NAVIGATION SWITCHES
 PUSHBUTTON SWITCHES
 TOGGLE SWITCHES
 ROCKER SWITCHES
 SLIDE SWITCHES
 SNAP-ACTION SWITCHES
 DIP SWITCHES
 KEYLOCK SWITCHES
 ROTARY SWITCHES
 DETECTOR SWITCHES
 CAP OPTIONS

SERIES 100 SWITCHES

TOGGLE SWITCHES - MINIATURE

VS21-VS31

SPDT



Option Code	Dim. 'A'
VS2	.460 (11.68)
VS3	.630 (16.00)



P.C. MOUNTING

VS21-VS31

DPDT



Option Code	Dim. 'A'
VS2	.460 (11.68)
VS3	.630 (16.00)



P.C. MOUNTING

OPTIONAL TOGGLE CAP



Use with T1
T100-1 WHITE
T100-2 BLACK



CONTACT MATERIAL OPTIONS

Q

Fixed Terminal:	Silver plated over copper alloy
Moving Contact:	Silver plated over copper alloy
Rating:	5 Amps with resistive load @ 120VAC or 28VDC; 2 Amps with resistive load @ 250VAC

R

Fixed Terminal:	Copper alloy with gold plate over nickel plate
Moving Contact:	Copper alloy with gold plate over nickel plate
Rating:	0.4 Volt-Amps (VA) max. @ 20V max. (AC or DC)



HARDWARE

HDW2 1/4 IN. NUTS

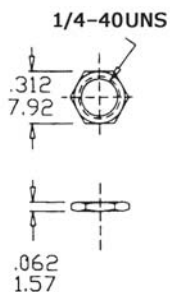

Supplied standard with B1, B3, B5, B6 and B9 options

HDW3 BLIND DRESSNUT



HDW6 METRIC NUT



Supplied standard with B8 metric bushing

HDW11 LOCK WASHER



Supplied standard with B1/B3 bushing

Optional Rubber Hood Sealing E1



E1= Inch (Std.) for actuator T1, T2 and bushings B1, B3, B5, B6 Optional rubber boot sealing

HDW4 15/32 IN. NUTS

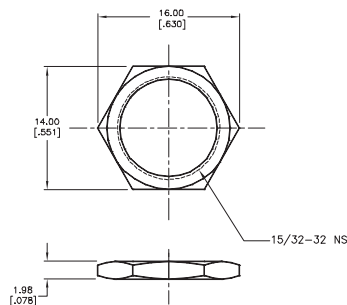

Supplied standard with B13 bushing

HDW12 LOCK WASHER



Supplied standard with B13 bushing

HDW15 LOCKING RING



Supplied standard

HDW16 LOCKING RING



Supplied with B5 bushing

HDW17 LOCKING RING



Supplied with B13 bushing

TACT SWITCHES

NAVIGATION SWITCHES

PUSHBUTTON SWITCHES

TOGGLE SWITCHES

ROCKER SWITCHES

SLIDE SWITCHES

SNAP-ACTION SWITCHES

DIP SWITCHES

KEYLOCK SWITCHES

ROTARY SWITCHES

DETECTOR SWITCHES

CAP OPTIONS

Mouser Electronics

Authorized Distributor

Click to View Pricing, Inventory, Delivery & Lifecycle Information:

E-Switch:

[100DP1T2B4M6QE](#) [100DP1T6B11M51QEH](#) [100DP1T8B13M1QEH](#) [100SP2T1B1M1QEH](#) [100SP3T4B1M1QEH](#)
[100SP1T4B1M1QEH](#) [100SP5T2B1M2QH](#) [100SP1T1B4M7RE](#) [100SP1T1B4M7QE](#) [100SP1T2B3M2QEH](#)
[100DP3T1B9M1QEH](#) [100SP1T1B9M1QEH](#) [100SP4T1B9M1QEH](#) [100SP1T2B4VS2QE](#) [100SP3T1B9M1QEH](#)
[100DP3T1B4M7QE](#) [100DP1T1B9M1QEH](#) [100SP1T8B13M1QEH](#) [100DP5T1B1M1QEH](#) [100SP1T6B12M6RE](#)
[100SP3T1B4M6RE](#) [1003P2T1B1M1QEH](#) [100SP3T2B4M6RE](#) [100SP1T1B4M6RE](#) [100SP1T1B4M2QE](#)
[100SP1T1B4VS2RE](#) [100SP1T1B1M51REH](#) [100SP4T2B4M6RE](#) [100DP3T2B4VS2RE](#) [1003P1T1B1M2QEH](#)
[100SP1T2B4VS3RE](#) [100DP2T8B13M1QEH](#) [1003P1T1B1M1QEH](#) [100DP3T6B2M7QE](#) [100SP1T2B1M1QEH](#)
[100DP3T2B1M2QEH](#) [100DP1T2B3M1QEH](#) [100SP1T1B1M1QEH](#) [100SP1T1B1M1REH](#) [100SP1T1B1M2QEH](#)
[100SP1T1B1M2REH](#) [100SP2T2B1M1QEH](#) [100SP1T2B3M1QEH](#) [100SP1T2B4VS2RE](#) [1004P3T1B1M7QEH](#)
[100SP1T2B4M7RE](#) [100SP1T6B11M2QEH](#) [100SP3T8B13M1QEH](#) [100SP1T6B11M1QEH](#) [100SP3T1B1M2QEH](#)
[100SP1T6B11M1REH](#) [100SP3T1B1M1REH](#) [100SP3T1B1M1QEH](#) [1003P1T2B4M7RE](#) [1004P1T1B1M1QEH](#)
[1004P1T1B1M2QEH](#) [1004P3T1B1M1QEH](#) [1004P4T1B1M1QEH](#) [1004P6T1B1M1QEH](#) [100SP4T6B11M2QEH](#)
[100SP3T2B4M7RE](#) [100SP5T2B4M7RE](#) [1004P1T2B4M7QE](#) [100DP1T2B4VS2RE](#) [100DP4T4B9M2QEH](#)
[100SP1T1B6M1QEH](#) [100DP6T1B1M2QEH](#) [100SP1T9B4M2Q](#) [100SP4T1B1M1QEH](#) [100SP1T2B4M6RE](#)
[100SP5T6B11M1QEH](#) [100SP1T2B4M6QE](#) [100SP4T2B3M1QEH](#) [100SP2T1B1M2QEH](#) [100SP4T1B1M2QEH](#)
[100DP3T4B1M1QEH](#) [100DP1T4B1M1QEH](#) [100DP4T6B11M1QEH](#) [100SP3T2B4M7QE](#) [100DP3T8B13M1QEH](#)
[100DP1T1B1M2QEH](#) [100DP1T1B1M2REH](#) [100DP1T1B1M1REH](#) [100DP2T6B11M1QEH](#) [100DP1T1B1M1QEH](#)
[100SP3T2B4VS2QE](#) [100SP3T2B4VS2RE](#) [100SP5T2B4M6RE](#) [100DP3T2B3M2QEH](#) [100DP2T1B1M1QEH](#)
[100DP4T1B1M1QEH](#) [100SP5T1B1M2QEH](#) [100SP3T6B11M2QEH](#) [100SP5T1B1M1QEH](#) [100SP3T6B11M1QEH](#)
[100SP1T6B2M7QE](#) [100DP5T6B11M1QEH](#) [100SP1T1B2M54QE](#) [100DP3T1B1M2QEH](#) [100SP2T6B11M1QEH](#)