



Connectors > Connector Accessories > Connector Caps & Covers



Connector Cover Type: **Dust Cover**

### Features

#### Product Type Features

Connector Cover Type	Dust Cover
----------------------	------------

#### Housing Features

Compatible With Connector Shape	Rectangular
---------------------------------	-------------

### Product Compliance

[For compliance documentation, visit the product page on TE.com>](#)

EU RoHS Directive 2011/65/EU	Compliant
EU ELV Directive 2000/53/EC	Compliant
China RoHS 2 Directive MIIT Order No 32, 2016	No Restricted Materials Above Threshold
EU REACH Regulation (EC) No. 1907/2006	Current ECHA Candidate List: JUNE 2024 (241) Candidate List Declared Against: JUNE 2024 (241) Does not contain REACH SVHC
Halogen Content	Not Low Halogen - contains Br or Cl > 900 ppm.
Solder Process Capability	Not applicable for solder process capability

#### Product Compliance Disclaimer

This information is provided based on reasonable inquiry of our suppliers and represents our current actual knowledge based on the information they provided. This information is subject to change. The part numbers that TE has identified as EU RoHS compliant have a maximum concentration of 0.1% by weight in homogenous materials for lead, hexavalent chromium, mercury, PBB, PBDE, DBP, BBP, DEHP, DIBP, and 0.01% for cadmium, or qualify for an exemption to these

limits as defined in the Annexes of Directive 2011/65/EU (RoHS2). Finished electrical and electronic equipment products will be CE marked as required by Directive 2011/65/EU. Components may not be CE marked. Additionally, the part numbers that TE has identified as EU ELV compliant have a maximum concentration of 0.1% by weight in homogenous materials for lead, hexavalent chromium, and mercury, and 0.01% for cadmium, or qualify for an exemption to these limits as defined in the Annexes of Directive 2000/53/EC (ELV). Regarding the REACH Regulation, the information TE provides on SVHC in articles for this part number is based on the latest European Chemicals Agency (ECHA) 'Guidance on requirements for substances in articles' posted at this URL: <https://echa.europa.eu/guidance-documents/guidance-on-reach>

## Compatible Parts

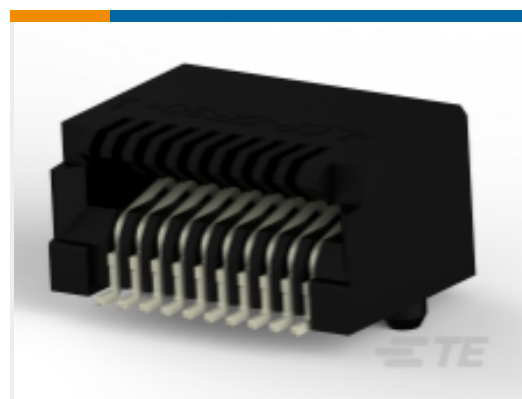

TE Part # CAT-SF59-C76264  
SFP Connectors



TE Part # CAT-SF59-C117ST123  
SFP+ Stacked Cage Assemblies

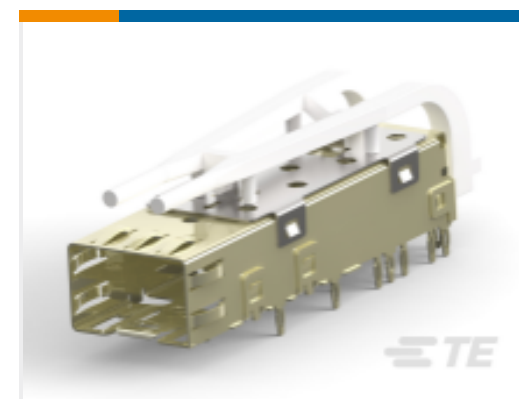

TE Part # 1367629-2  
cage assy, 20 press fit, sfp w



TE Part # 2007194-1  
SFP+ 1x1 Cage Assembly, PCI, Solder Tail



TE Part # 2007251-1  
SFP+ 1x6 Cage Assembly



TE Part # 1761008-3  
SFP 1X4 CAGE & LIGHT PIPE KIT



TE Part # 2007178-1  
SFP+ 1x4 Cage Assembly, Light

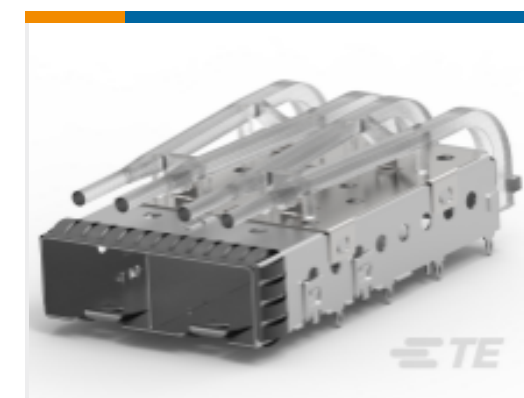

TE Part # 2007262-1  
SFP+ 1x2 Cage Assembly, Light

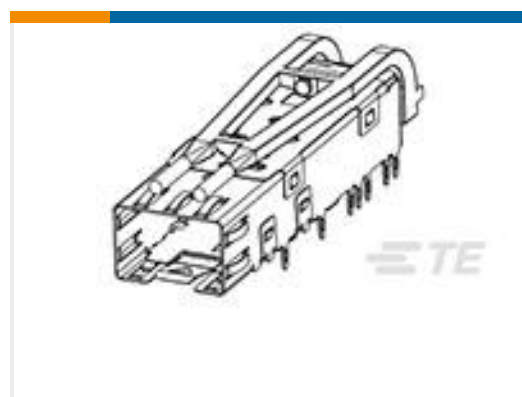

TE Part # 2170614-1  
cage assy, 20 press fit, sfp w



TE Part # 2007263-1  
SFP+ 1x2 Cage Assembly



TE Part # 2007464-3  
SFP+ 1x1 Cage Assy, PF,with Heatsink



TE Part # 2007198-1  
SFP+ 1x1 Cage Assembly, Press-

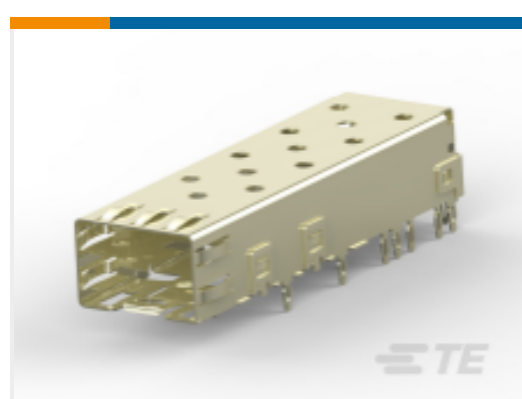

TE Part # 2227023-1  
CAGE ASSY PRESS FIT, SFP



TE Part # 2007464-2  
SFP+ 1x1 Cage Assy, PF,with Heatsink

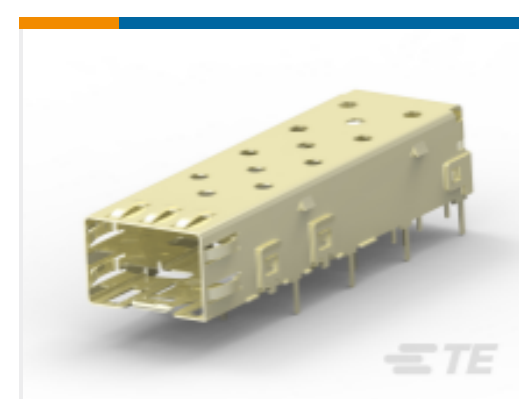

TE Part # 2227303-1  
CAGE ASSEMBLY, SFP, .140 SOLDE

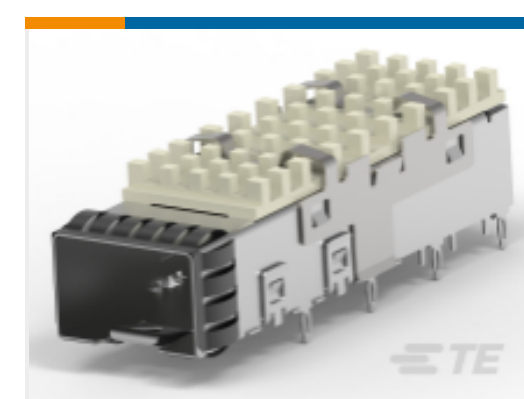

TE Part # 2007464-1  
SFP+ 1x1 Cage Assy, PF,with Heatsink



TE Part # 2007132-1  
SFP+ 1X4 Cage Assembly, Press-



TE Part # 1658744-3  
SFP 1X4 CAGE ASSY



TE Part # 2227303-2  
CAGE ASSEMBLY, SFP, .071 TAIL



TE Part # 2227302-1  
CAGE ASSY, PRESS FIT, SFP

## Customers Also Bought



TE Part #5084616-4  
0.8FH,R13H.5,100,08/Sn,TR,SC



TE Part #2420735-1  
SSA Cord 1.6mm x 1m L



TE Part #1982260-5  
Z-PACK Slim UHD Power 5 pos pl



TE Part #374730-E  
MSPEED 50 F SMD F4 E AB VV 137  
094 \* \* E



TE Part #146839-3  
CF HDR,SMT,50P,VERT,TYPE 1,LEAD  
FREE



TE Part #2041307-2  
RJ45, SHIELDED, OFFSET, DIP, 30U',  
H=8.2

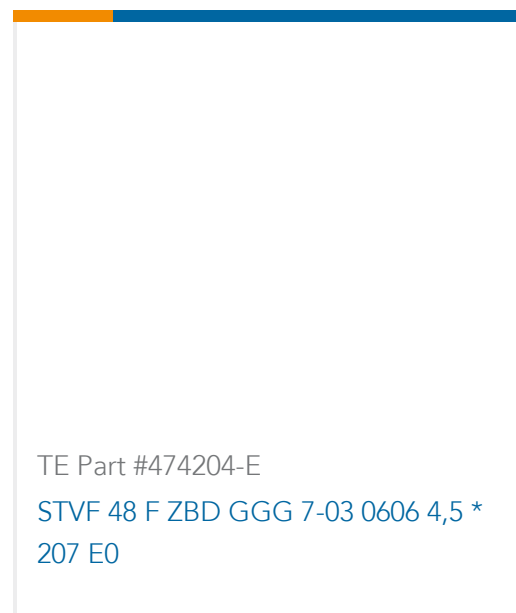

TE Part #474204-E  
STVF 48 F ZBD GGG 7-03 0606 4,5 \*  
207 E0

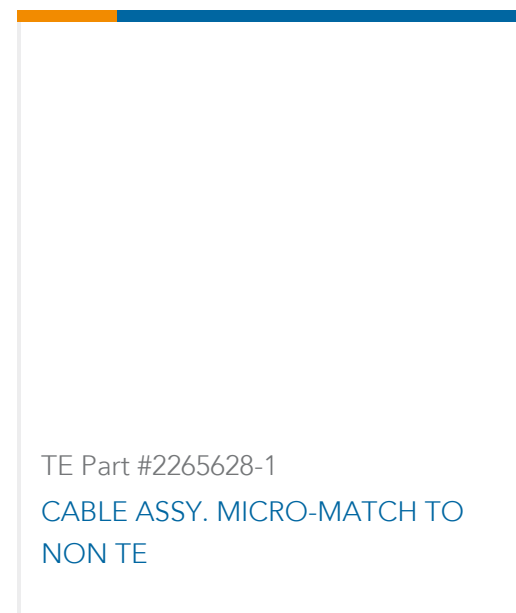

TE Part #2265628-1  
CABLE ASSY. MICRO-MATCH TO  
NON TE



TE Part #454998-E  
MSPEED 83 F SMD F8 BE A-G 9999  
137 094 \*

## Documents

### Product Drawings

SFP COVER, UNPL, NO LOGO

English

### CAD Files

Customer View Model

[ENG\\_CVM\\_1367147-3\\_C.2d\\_dxf.zip](#)

English

Customer View Model



[ENG\\_CVM\\_1367147-3\\_C.3d\\_igs.zip](#)

English

**Customer View Model**

[ENG\\_CVM\\_1367147-3\\_C.3d\\_stp.zip](#)

English

**3D PDF**

English

By downloading the CAD file I accept and agree to the [Terms and Conditions](#) of use.

---

### Datasheets & Catalog Pages

[1773408-1 Pluggable Input/Output Solutions catalog - SFP section](#)

English

[4-1773455-3 - Quick Reference Guide SFP+ Solutions](#)

English

[4-1773455-4 Quick Reference Guide SFP Solutions](#)

English

---

### Product Specifications

[Application Specification](#)

English

---

### Instruction Sheets

[Instruction Sheet \(U.S.\)](#)

English