

PT 4-WE/16 - Panel feed-through terminal block



3044921

<https://www.phoenixcontact.com/us/products/3044921>

Please be informed that the data shown in this PDF document is generated from our online catalog. Please find the complete data in the user documentation. Our general terms of use for downloads are valid.



Panel feed-through terminal block, nom. voltage: 500 V, nominal current: 24 A, number of connections: 32, number of positions: 16, connection method: Push-in connection, Rated cross section: 4 mm², cross section: 0.14 mm² - 4 mm², mounting type: Wall mounting, color: gray

Your advantages

- Easy grouping with engagement pin versions
- CLIPLINE complete accessories for easy bridging, testing, and marking
- Easy connection of the conductors, thanks to fast Push-in spring connection
- Highly flexible, thanks to alignable single terminal blocks
- Automatic compensation of the panel thickness via the snap principle integrated in the insulation housing

Commercial data

Item number	3044921
Packing unit	1 pc
Note	Made to order (non-returnable)
Sales key	BE06
Product key	BE6112
Catalog page	Page 653 (C-1-2019)
GTIN	4055626245812
Weight per piece (including packing)	105.53 g
Weight per piece (excluding packing)	105.53 g
Customs tariff number	85369010
Country of origin	RU

PT 4-WE/16 - Panel feed-through terminal block



3044921

<https://www.phoenixcontact.com/us/products/3044921>

Technical data

Notes

Assembly note	Minimum distance to other conductive surfaces: min 5 mm
---------------	---

Product properties

Product type	Feed-through terminal block
Product family	PT 4-WE
Number of positions	16
Pitch	5.2 mm
Number of connections	32
Number of rows	1
Potentials	16

Insulation characteristics

Overvoltage category	III
Degree of pollution	3

Electrical properties

Maximum power dissipation for nominal condition	1.02 W
---	--------

Connection data

Nominal cross section	4 mm ²
Rated cross section AWG	14
Note	Derating curve on request.
Stripping length	10 mm ... 12 mm
Internal cylindrical gage	A3
Connection in acc. with standard	IEC 60947-7-1
Conductor cross section rigid	0.14 mm ² ... 4 mm ²
Cross section AWG	26 ... 12 (converted acc. to IEC)
Conductor cross section flexible	0.14 mm ² ... 4 mm ²
Conductor cross section, flexible [AWG]	26 ... 12 (converted acc. to IEC)
Conductor cross-section flexible (ferrule without plastic sleeve)	0.14 mm ² ... 2.5 mm ²
Flexible conductor cross section (ferrule with plastic sleeve)	0.14 mm ² ... 2.5 mm ²
2 conductors with the same cross section, flexible, with TWIN ferrule with plastic sleeve	0.5 mm ² ... 0.5 mm ²
Nominal current	24 A
Maximum load current	30 A (with 6 mm ² conductor cross section, rigid)
Nominal voltage	500 V
Nominal cross section	4 mm ²

Connection cross sections directly pluggable

Conductor cross section rigid	0.34 mm ² ... 4 mm ²
Conductor cross section, rigid [AWG]	24 ... 12 (converted acc. to IEC)
Conductor cross-section flexible (ferrule without plastic sleeve)	0.34 mm ² ... 2.5 mm ²

PT 4-WE/16 - Panel feed-through terminal block

3044921

<https://www.phoenixcontact.com/us/products/3044921>

Flexible conductor cross section (ferrule with plastic sleeve)	0.34 mm ² ... 2.5 mm ²
--	--

Dimensions

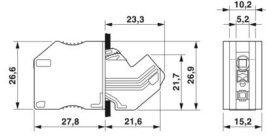
Dimensional drawing	
Width	87.4 mm
Height	26.6 mm
Pitch	5.2 mm
Plate thickness	1 mm ... 2.5 mm

Material specifications

Color	gray
Flammability rating according to UL 94	V0
Insulating material	PA
Static insulating material application in cold	-60 °C
Temperature index of insulation material (DIN EN 60216-1 (VDE 0304-21))	125 °C
Relative insulation material temperature index (Elec., UL 746 B)	130 °C
Fire protection for rail vehicles (DIN EN 45545-2) R22	HL 1 - HL 3
Fire protection for rail vehicles (DIN EN 45545-2) R23	HL 1 - HL 3
Fire protection for rail vehicles (DIN EN 45545-2) R24	HL 1 - HL 3
Fire protection for rail vehicles (DIN EN 45545-2) R26	HL 1 - HL 3
Calorimetric heat release NFPA 130 (ASTM E 1354)	27,5 MJ/kg
Surface flammability NFPA 130 (ASTM E 162)	passed
Specific optical density of smoke NFPA 130 (ASTM E 662)	passed
Smoke gas toxicity NFPA 130 (SMP 800C)	passed

Electrical tests

Surge voltage test

Test voltage setpoint	7.3 kV
Result	Test passed

Temperature-rise test

Requirement temperature-rise test	Increase in temperature ≤ 45 K
Result	Test passed
Short-time withstand current 2.5 mm ²	0.15 kA
Short-time withstand current 4 mm ²	0.15 kA
Short-time withstand current 2.5 mm ²	0.3 kA
Short-time withstand current 4 mm ²	0.3 kA
Short-time withstand current 2.5 mm ²	0.5 kA
Result	Test passed

PT 4-WE/16 - Panel feed-through terminal block



3044921

<https://www.phoenixcontact.com/us/products/3044921>

Power-frequency withstand voltage

Test voltage setpoint	1.89 kV
Result	Test passed

Mechanical properties

Mechanical data

Open side panel	No
-----------------	----

Mechanical tests

Mechanical strength

Result	Test passed
--------	-------------

Attachment on the carrier

DIN rail/fixing support	NS 35
Test force setpoint	1 N
Result	Test passed

Test for conductor damage and slackening

Conductor cross section/weight	0.14 mm ² / 0.2 kg
	2.5 mm ² / 0.7 kg
	4 mm ² / 0.9 kg
Result	Test passed

Environmental and real-life conditions

Aging

Temperature cycles	192
Result	Test passed

Needle-flame test

Time of exposure	30 s
Result	Test passed

Oscillation/broadband noise

Specification	DIN EN 50155 (VDE 0115-200):2008-03
Spectrum	Service life test category 1, class B, body mounted
Frequency	$f_1 = 5 \text{ Hz}$ to $f_2 = 150 \text{ Hz}$
ASD level	0.964 (m/s ²)/Hz
Acceleration	0.58g
Test duration per axis	5 h
Test directions	X-, Y- and Z-axis
Result	Test passed

Shocks

Specification	DIN EN 50155 (VDE 0115-200):2008-03
Pulse shape	Half-sine

PT 4-WE/16 - Panel feed-through terminal block



3044921

<https://www.phoenixcontact.com/us/products/3044921>

Acceleration	5g
Shock duration	30 ms
Number of shocks per direction	3
Test directions	X-, Y- and Z-axis (pos. and neg.)
Result	Test passed

Ambient conditions

Ambient temperature (storage/transport)	-25 °C ... 60 °C (for a short time, not exceeding 24 h, -60 °C to +70 °C)
Ambient temperature (assembly)	-5 °C ... 70 °C
Ambient temperature (actuation)	-5 °C ... 70 °C
Permissible humidity (storage/transport)	30 % ... 70 %

Standards and regulations

Connection in acc. with standard	IEC 60947-7-1
----------------------------------	---------------

Mounting

Mounting type	Wall mounting
---------------	---------------

PT 4-WE/16 - Panel feed-through terminal block



3044921

<https://www.phoenixcontact.com/us/products/3044921>

Drawings

Dimensional drawing

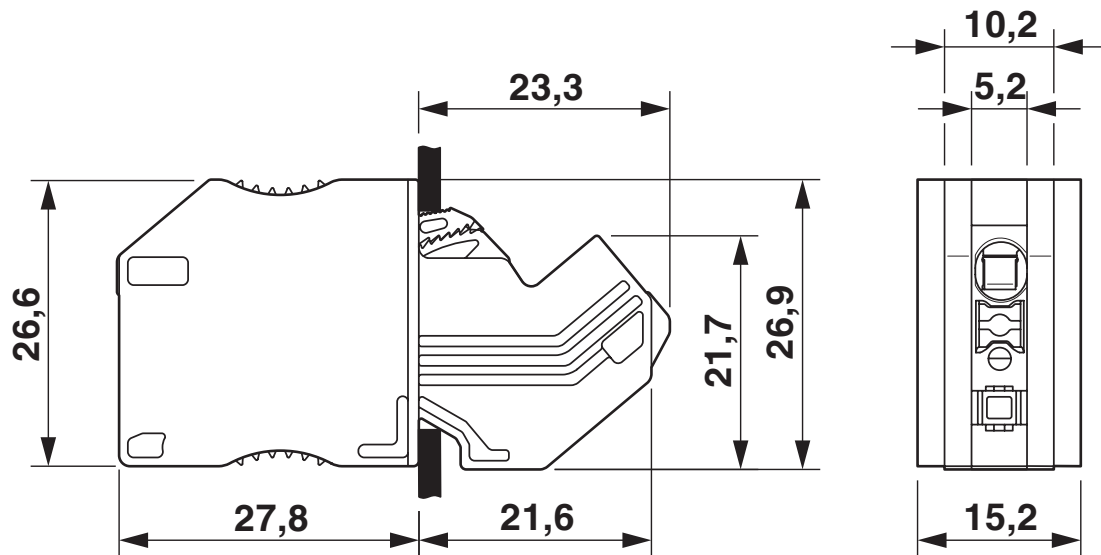

Circuit diagram



PT 4-WE/16 - Panel feed-through terminal block



3044921

<https://www.phoenixcontact.com/us/products/3044921>

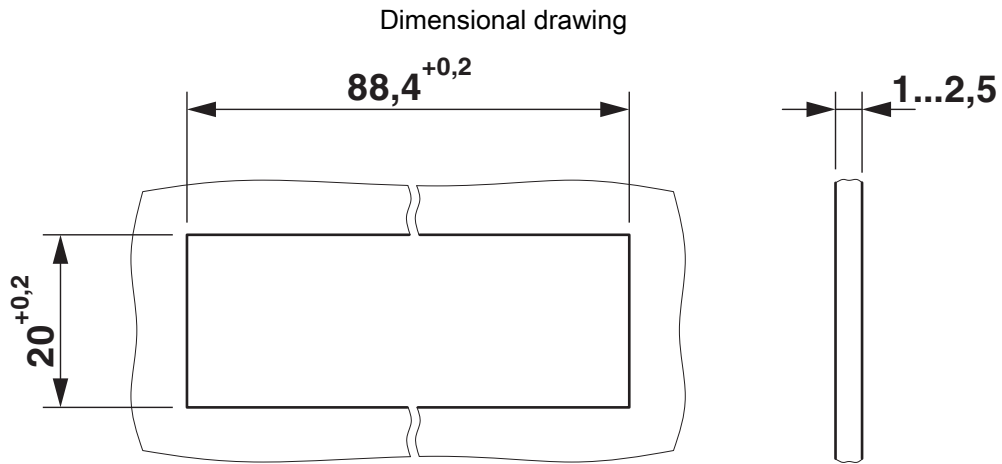

Schematic diagram

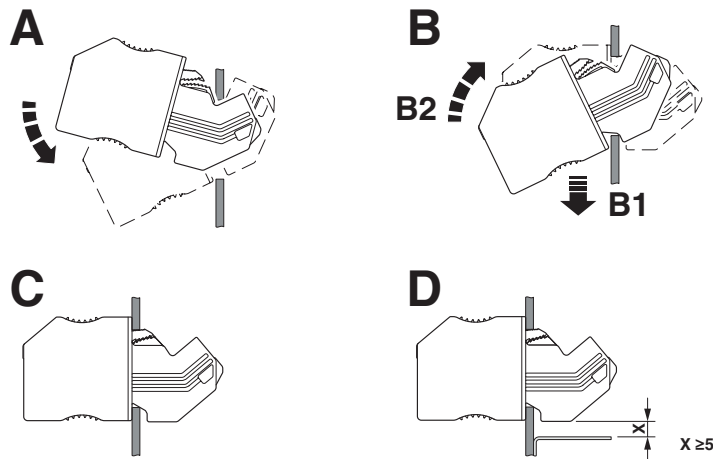

Assembly drawing

PT 4-WE/16 - Panel feed-through terminal block



3044921

<https://www.phoenixcontact.com/us/products/3044921>

Classifications

ECLASS

ECLASS-11.0

27141120

ETIM

ETIM 8.0

EC000897

UNSPSC

UNSPSC 21.0

39121400

PT 4-WE/16 - Panel feed-through terminal block



3044921

<https://www.phoenixcontact.com/us/products/3044921>

Environmental product compliance

EU RoHS

Fulfills EU RoHS substance requirements	Yes, No exemptions
---	--------------------

China RoHS

Environment friendly use period (EFUP)	EFUP-E
	No hazardous substances above the limits

EU REACH SVHC

REACH candidate substance (CAS No.)	No substance above 0.1 wt%
-------------------------------------	----------------------------

PT 4-WE/16 - Panel feed-through terminal block

3044921

<https://www.phoenixcontact.com/us/products/3044921>

Accessories

 Note: Applying some accessories below might limit this product.

FBS 2-5 - Plug-in bridge

3030161

<https://www.phoenixcontact.com/us/products/3030161>



Plug-in bridge, pitch: 5.2 mm, number of positions: 2, length: 23 mm, color: red

 Max. current carrying capacity: 24 A

FBS 3-5 - Plug-in bridge

3030174

<https://www.phoenixcontact.com/us/products/3030174>



Plug-in bridge, pitch: 5.2 mm, number of positions: 3, length: 23 mm, color: red

 Max. current carrying capacity: 24 A

PT 4-WE/16 - Panel feed-through terminal block



3044921

<https://www.phoenixcontact.com/us/products/3044921>

FBS 4-5 - Plug-in bridge

3030187

<https://www.phoenixcontact.com/us/products/3030187>



Plug-in bridge, pitch: 5.2 mm, number of positions: 4, length: 23 mm, color: red

 Max. current carrying capacity: 24 A

FBS 5-5 - Plug-in bridge

3030190

<https://www.phoenixcontact.com/us/products/3030190>



Plug-in bridge, pitch: 5.2 mm, number of positions: 5, length: 23 mm, color: red

 Max. current carrying capacity: 24 A

PT 4-WE/16 - Panel feed-through terminal block



3044921

<https://www.phoenixcontact.com/us/products/3044921>

FBS 10-5 - Plug-in bridge

3030213

<https://www.phoenixcontact.com/us/products/3030213>



Plug-in bridge, pitch: 5.2 mm, number of positions: 10, length: 23 mm, color: red

 Max. current carrying capacity: 24 A

FBS 20-5 - Plug-in bridge

3030226

<https://www.phoenixcontact.com/us/products/3030226>



Plug-in bridge, pitch: 5.2 mm, number of positions: 20, color: red

 Max. current carrying capacity: 24 A

PT 4-WE/16 - Panel feed-through terminal block

3044921

<https://www.phoenixcontact.com/us/products/3044921>



FBS 50-5 - Plug-in bridge

3038930

<https://www.phoenixcontact.com/us/products/3038930>



Plug-in bridge, pitch: 5.2 mm, number of positions: 50, color: red

 Max. current carrying capacity: 24 A

FBSR 2-5 - Plug-in bridge

3033702

<https://www.phoenixcontact.com/us/products/3033702>



Plug-in bridge, pitch: 5.2 mm, number of positions: 2, color: red

 Max. current carrying capacity: 17.5 A

PT 4-WE/16 - Panel feed-through terminal block

3044921

<https://www.phoenixcontact.com/us/products/3044921>

FBSR 3-5 - Plug-in bridge

3001591

<https://www.phoenixcontact.com/us/products/3001591>



Plug-in bridge, pitch: 5.2 mm, number of positions: 3, color: red

 Max. current carrying capacity: 17.5 A

FBSR 4-5 - Plug-in bridge

3001592

<https://www.phoenixcontact.com/us/products/3001592>



Plug-in bridge, pitch: 5.2 mm, number of positions: 4, color: red

 Max. current carrying capacity: 17.5 A

PT 4-WE/16 - Panel feed-through terminal block

3044921

<https://www.phoenixcontact.com/us/products/3044921>



FBSR 5-5 - Plug-in bridge

3001593

<https://www.phoenixcontact.com/us/products/3001593>

Plug-in bridge, pitch: 5.2 mm, number of positions: 5, color: red



 Max. current carrying capacity: 17.5 A

FBSR 10-5 - Plug-in bridge

3033710

<https://www.phoenixcontact.com/us/products/3033710>

Plug-in bridge, pitch: 5.2 mm, number of positions: 10, color: red



 Max. current carrying capacity: 17.5 A

PT 4-WE/16 - Panel feed-through terminal block

3044921

<https://www.phoenixcontact.com/us/products/3044921>

FBS 2-5 BU - Plug-in bridge

3036877

<https://www.phoenixcontact.com/us/products/3036877>



Plug-in bridge, pitch: 5.2 mm, number of positions: 2, color: blue

 Max. current carrying capacity: 24 A

FBS 3-5 BU - Plug-in bridge

3036880

<https://www.phoenixcontact.com/us/products/3036880>



Plug-in bridge, pitch: 5.2 mm, number of positions: 3, color: blue

 Max. current carrying capacity: 24 A

PT 4-WE/16 - Panel feed-through terminal block

3044921

<https://www.phoenixcontact.com/us/products/3044921>



FBS 4-5 BU - Plug-in bridge

3036893

<https://www.phoenixcontact.com/us/products/3036893>



Plug-in bridge, pitch: 5.2 mm, number of positions: 4, color: blue

 Max. current carrying capacity: 24 A

FBS 5-5 BU - Plug-in bridge

3036903

<https://www.phoenixcontact.com/us/products/3036903>



Plug-in bridge, pitch: 5.2 mm, number of positions: 5, color: blue

 Max. current carrying capacity: 24 A

PT 4-WE/16 - Panel feed-through terminal block

3044921

<https://www.phoenixcontact.com/us/products/3044921>

FBS 10-5 BU - Plug-in bridge

3036916

<https://www.phoenixcontact.com/us/products/3036916>



Plug-in bridge, pitch: 5.2 mm, number of positions: 10, color: blue

 Max. current carrying capacity: 24 A

FBS 20-5 BU - Plug-in bridge

3036929

<https://www.phoenixcontact.com/us/products/3036929>



Plug-in bridge, pitch: 5.2 mm, number of positions: 20, color: blue

 Max. current carrying capacity: 24 A

PT 4-WE/16 - Panel feed-through terminal block



3044921

<https://www.phoenixcontact.com/us/products/3044921>

FBS 50-5 BU - Plug-in bridge

3032114

<https://www.phoenixcontact.com/us/products/3032114>



Plug-in bridge, pitch: 5.2 mm, number of positions: 50, color: blue

 Max. current carrying capacity: 24 A

D-PT 4-WE - End cover

3044902

<https://www.phoenixcontact.com/us/products/3044902>



End cover, Right / left, width: 5 mm, height: 26.9 mm, color: gray

PT 4-WE/16 - Panel feed-through terminal block



3044921

<https://www.phoenixcontact.com/us/products/3044921>

SZF 1-0,6X3,5 - Screwdriver

1204517

<https://www.phoenixcontact.com/us/products/1204517>



Actuation tool, for ST terminal blocks, also suitable for use as a bladed screwdriver, size: 0.6 x 3.5 x 100 mm, 2-component grip, with non-slip grip

ST-BW - Actuation tool

1207608

<https://www.phoenixcontact.com/us/products/1207608>



Actuation tool, for all 2.5 mm² - 4.0 mm² spring-cages

PT 4-WE/16 - Panel feed-through terminal block



3044921

<https://www.phoenixcontact.com/us/products/3044921>

ZBF 5:UNBEDRUCKT - Zack Marker strip, flat

0808642

<https://www.phoenixcontact.com/us/products/0808642>



Zack Marker strip, flat, Strip, white, unlabeled, can be labeled with: PLOTMARK, CMS-P1-PLOTTER, mounting type: snapped, for terminal block width: 5 mm, lettering field size: 5.1 x 5.2 mm, Number of individual labels: 10

ZBF 5 CUS - Zack Marker strip, flat

0825025

<https://www.phoenixcontact.com/us/products/0825025>



Zack Marker strip, flat, can be ordered: Strip, white, labeled according to customer specifications, mounting type: snap into flat marker groove, for terminal block width: 5 mm, lettering field size: 5.15 x 5.15 mm, Number of individual labels: 10

PT 4-WE/16 - Panel feed-through terminal block



3044921

<https://www.phoenixcontact.com/us/products/3044921>

ZBF 5,LGS:FORTL.ZAHLEN - Zack Marker strip, flat

0808671

<https://www.phoenixcontact.com/us/products/0808671>



Zack Marker strip, flat, Strip, white, labeled, printed horizontally: consecutive numbers 1 ... 10, 11 ... 20, etc. up to 491 ... 500, mounting type: snapped, for terminal block width: 5 mm, lettering field size: 5.15 x 5.15 mm, Number of individual labels: 10

ZBF 5,QR:FORTL.ZAHLEN - Zack Marker strip, flat

0808697

<https://www.phoenixcontact.com/us/products/0808697>



Zack Marker strip, flat, Strip, white, labeled, Printed vertically: consecutive numbers 1 ... 10, 11 ... 20, etc. up to 91 ... 100, mounting type: snapped, for terminal block width: 5 mm, lettering field size: 5.15 x 5.15 mm, Number of individual labels: 10

PT 4-WE/16 - Panel feed-through terminal block



3044921

<https://www.phoenixcontact.com/us/products/3044921>

ZBF 5,LGS:GERADE ZAHLEN - Zack Marker strip, flat

0810821

<https://www.phoenixcontact.com/us/products/0810821>



Zack Marker strip, flat, Strip, white, labeled, printed horizontally: consecutive even numbers 2 ... 20, 22 ... 40, etc. up to 82 ... 100, mounting type: snapped, for terminal block width: 5 mm, lettering field size: 5.15 x 5.15 mm, Number of individual labels: 10

ZBF 5,LGS:UNGERADE ZAHLEN - Zack Marker strip, flat

0810863

<https://www.phoenixcontact.com/us/products/0810863>



Zack Marker strip, flat, Strip, white, labeled, printed horizontally: Odd numbers 1 - 19, 21 - 39, etc. up to 81 - 99, mounting type: snapped, for terminal block width: 5 mm, lettering field size: 5.15 x 5.15 mm, Number of individual labels: 10

PT 4-WE/16 - Panel feed-through terminal block



3044921

<https://www.phoenixcontact.com/us/products/3044921>

UC-TMF 5 - Marker for terminal blocks

0818153

<https://www.phoenixcontact.com/us/products/0818153>



Marker for terminal blocks, Sheet, white, unlabeled, can be labeled with: BLUEMARK ID COLOR, BLUEMARK ID, BLUEMARK CLED, PLOTMARK, CMS-P1-PLOTTER, mounting type: snapped, for terminal block width: 5.2 mm, lettering field size: 4.6 x 5.1 mm, Number of individual labels: 96

UC-TMF 5 CUS - Marker for terminal blocks

0824638

<https://www.phoenixcontact.com/us/products/0824638>

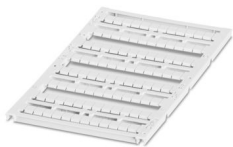

Marker for terminal blocks, can be ordered: by sheet, white, labeled according to customer specifications, mounting type: snap into flat marker groove, for terminal block width: 5.2 mm, lettering field size: 4.6 x 5.1 mm, Number of individual labels: 96

PT 4-WE/16 - Panel feed-through terminal block



3044921

<https://www.phoenixcontact.com/us/products/3044921>

UCT-TMF 5 - Marker for terminal blocks

0828744

<https://www.phoenixcontact.com/us/products/0828744>



Marker for terminal blocks, Sheet, white, unlabeled, can be labeled with: TOPMARK NEO, TOPMARK LASER, BLUEMARK ID COLOR, BLUEMARK ID, BLUEMARK CLED, THERMOMARK PRIME, THERMOMARK CARD 2.0, THERMOMARK CARD, mounting type: snapped, for terminal block width: 5.2 mm, lettering field size: 4.4 x 4.7 mm, Number of individual labels: 72

UCT-TMF 5 CUS - Marker for terminal blocks

0829658

<https://www.phoenixcontact.com/us/products/0829658>



Marker for terminal blocks, can be ordered: by sheet, white, labeled according to customer specifications, mounting type: snap into flat marker groove, for terminal block width: 5.2 mm, lettering field size: 4.4 x 4.7 mm, Number of individual labels: 72

PT 4-WE/16 - Panel feed-through terminal block

3044921

<https://www.phoenixcontact.com/us/products/3044921>



PS-5 - Test plug

3030983

<https://www.phoenixcontact.com/us/products/3030983>



Test plug, Modular test plug, number of positions: 1, color: red

DP PS-5 - Spacer plate

3036725

<https://www.phoenixcontact.com/us/products/3036725>



Spacer plate, depth: 29 mm, width: 5.2 mm, height: 22.4 mm, number of positions: 1, color: red

PT 4-WE/16 - Panel feed-through terminal block



3044921

<https://www.phoenixcontact.com/us/products/3044921>

PS-5/2,3MM RD - Test plug

3038723

<https://www.phoenixcontact.com/us/products/3038723>



Test plug, number of positions: 1, color: red

PAI-4 - Test adapter

3030925

<https://www.phoenixcontact.com/us/products/3030925>



Test adapter, Touch proof against unintentional direct contact according to DIN EN 50274 when plugged in, for 4 mm test plug and terminal blocks with 8.2 mm pitch, number of positions: 1, color: gray

Phoenix Contact 2024 © - all rights reserved
<https://www.phoenixcontact.com>

Phoenix Contact USA
586 Fulling Mill Road
Middletown, PA 17057, United States
(+717) 944-1300
info@phoenixcon.com