

## **Electronic Connectors**

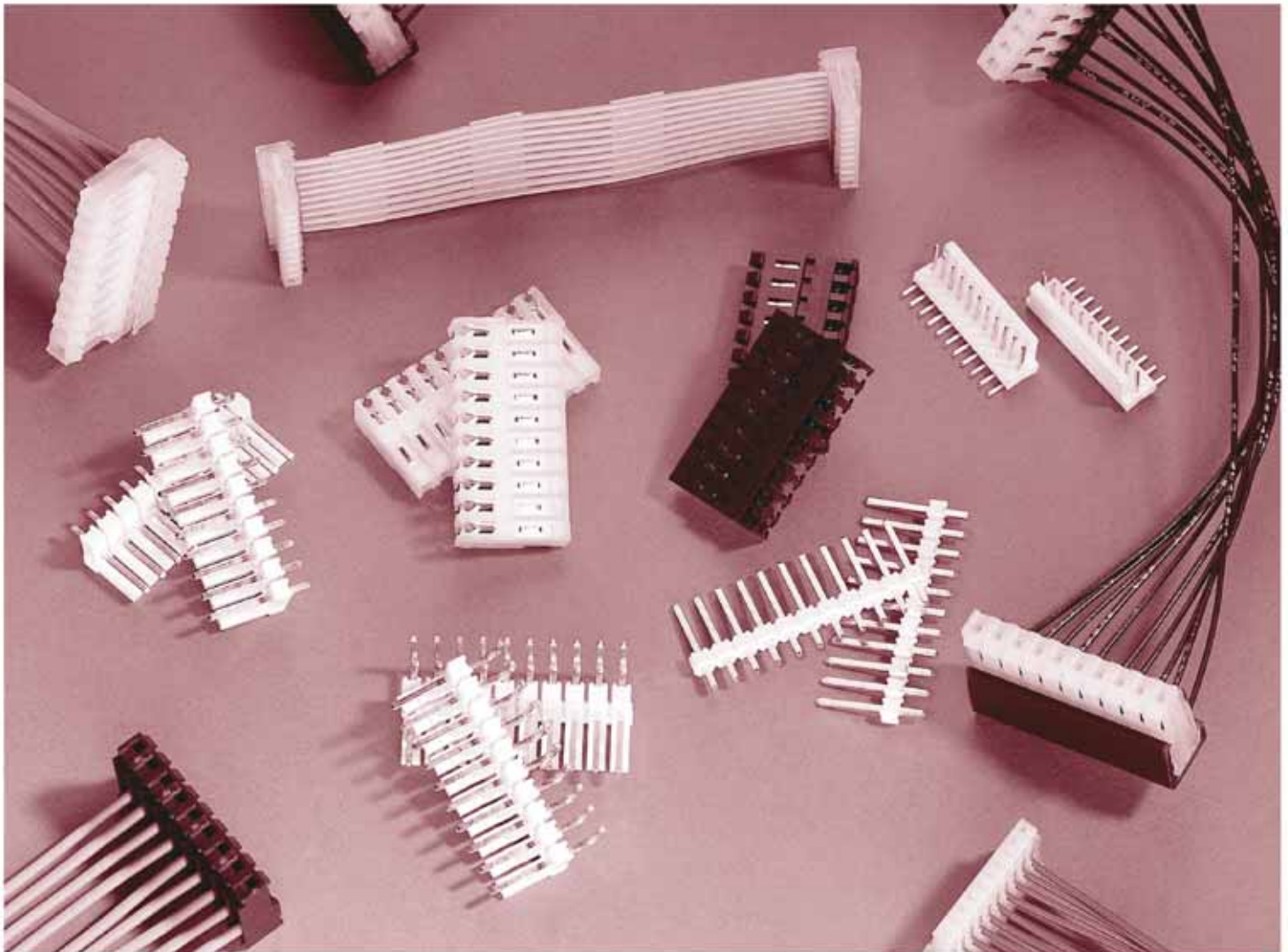

### **MAS-CON®** IDC Connector System

*IDC Mass Terminated Connector Systems,  
.100" and .156" for 28 AWG through 18 AWG*

**IDC Connectors**

**.100" and .156" QIDC  
Connector Selection Guide**

- 1** .100" Q Through connector dust cover Type TC  
..... **Page 7**
- 2** .100" Q In-line wire-to-wire splice Type MWWS  
..... **Page 19**
- 3** .100" Q Flat header Type MFSS  
..... **Page 8, 9**
- 4** .100" Q End connector Type CE and polarizing header Type MPSS  
..... **Page 7, 9**
- 5** .156" Q End connector Hi-Power Type CEH  
..... **Page 14**
- 6** .156" Q Strain Relief combination cover Type SCC  
..... **Page 13, 14**
- 7** .156" Q End connector Type CE  
..... **Page 12**
- 8** .156" Q In-line wire-to-wire splice Type MWWS  
..... **Page 19**
- 9** .156" Q End connector Type CE  
..... **Page 12**
- 10** .156" Q Locking header right angle post Type MLAS  
..... **Page 15**

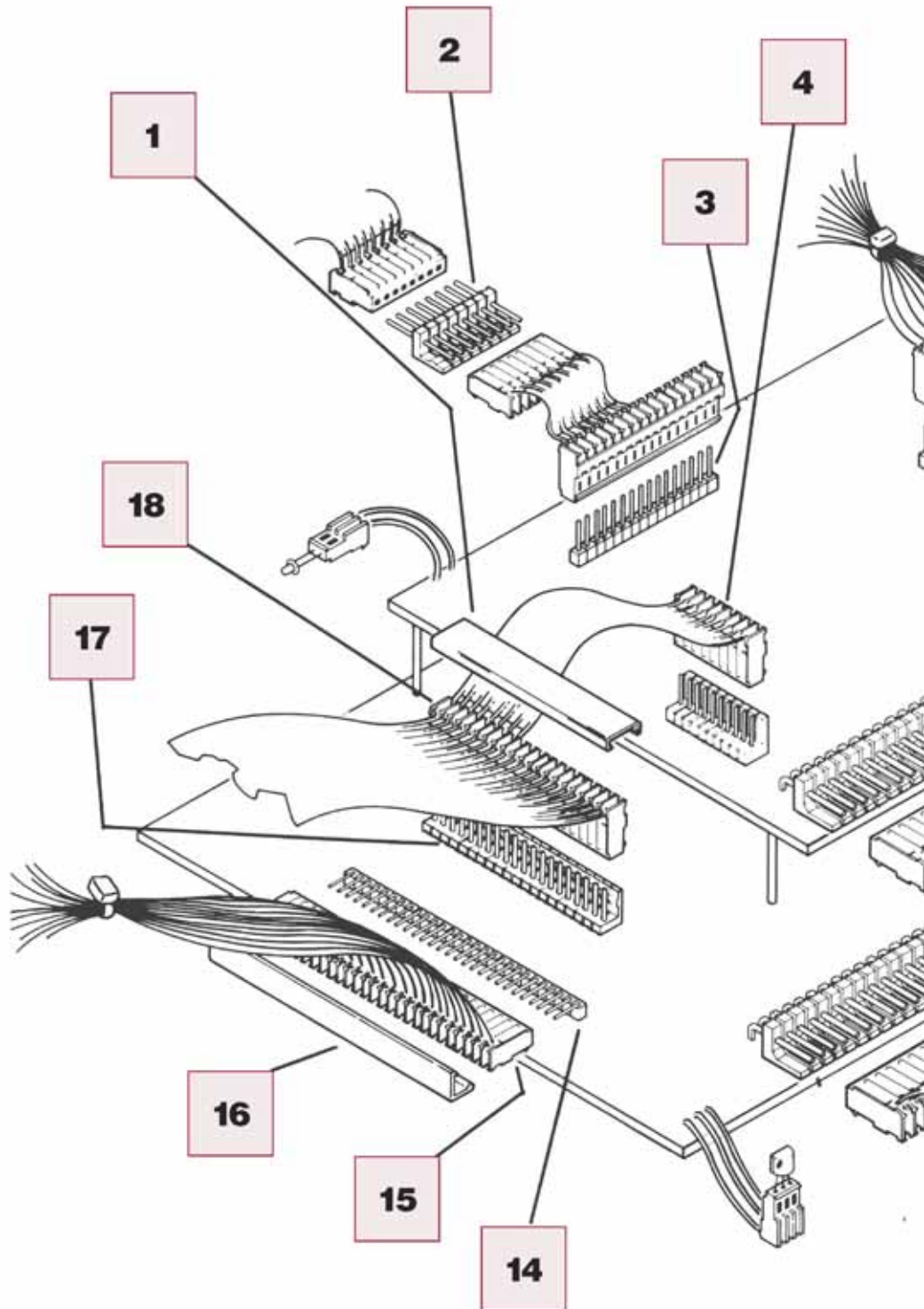

See page 6 for part number system



**IDC Connectors**

**.100" and .156" IDC  
Connector Selection Guide**

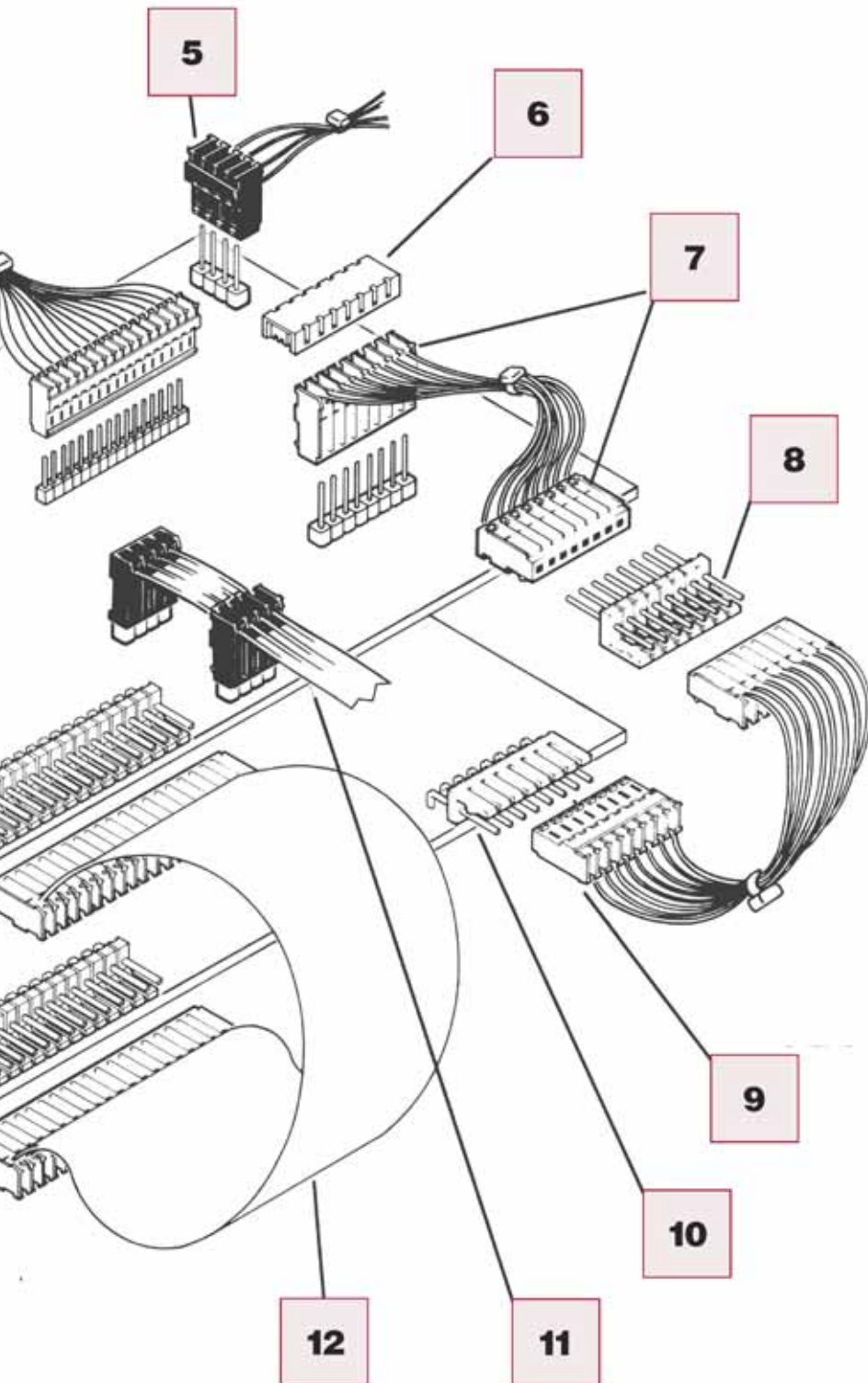

- 11** .156"  $\varnothing$  Through connector Type CTH Hi-Power daisy chain termination  
..... **Page 14**
- 12** .156"  $\varnothing$  PAN-FLEX™ Flat cable  
..... **Page 25**
- 14** .156"  $\varnothing$  Flat header right angle post Type MFAS  
..... **Page 15**
- 15** .100"  $\varnothing$  End connector Type CE  
..... **Page 6, 7**
- 16** .100"  $\varnothing$  End connector dust cover Type EC  
..... **Page 7**
- 17** .100"  $\varnothing$  Locking header Type MLSS  
..... **Page 8, 9**
- 18** .100"  $\varnothing$  Through connector Type CT showing daisy chain termination  
..... **Page 6, 7**
  
- Accessories  
..... **Page 16, 23**
  
- Tooling  
..... **Page 20, 21, 22, 23**
  
- Packaging Reel  
..... **Page 24**

**Mass Terminated Connectors**

**Mass Terminated Connector System reduces Installed Costs Due to Pre-Loaded IDC Contacts & Superior Application Tooling**

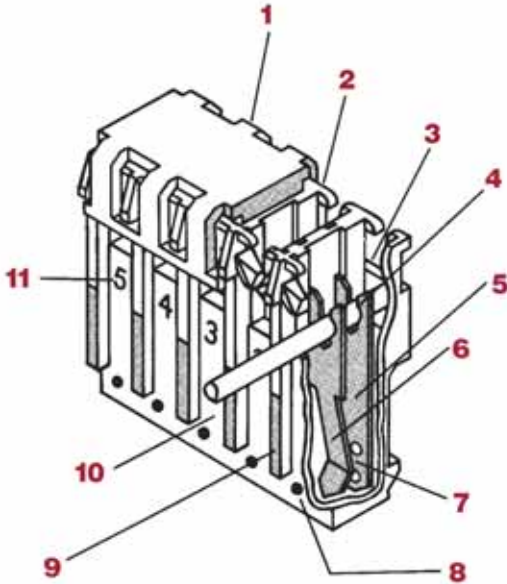

**MAS-CON Connectors**

- 1 Optional SNAP-ON covers; End (EC), through (TC), or strain relief combination cover (SCC) protect contacts and provide additional strain relief. (Cover type SCC shown)
- 2 Retainers hold wires prior to termination
- 3 Closed end (CE Type only)
- 4 Four gas tight connections per wire
- 5 Dual wipe connection to header post
- 6 Spring action contact design compensates for misalignment between header posts and connectors (3 points of contact)
- 7 Dimples (.156Q) assure sufficient mating force and 3 points of contact
- 8 Contrasting dots indicate through connectors type CT (Shown for reference only)
- 9 Color coded ribs for wire gauge identification
- 10 Contacts matched to wire gauge for optimum connections
- 11 Numbered circuit positions

**End and Through Connectors**

MAS-CON – pre-loaded insulation displacement contacts... eliminate wire stripping, crimping and hand loading contacts into housing – reducing overall installed costs.

Spacing/.100" Q		Spacing/.156" Q	
2.54 mm		3.96 mm	
Female	AWG	Female	
2 to 28 Circuits	28	2 to 24 Circuits	
	26		
	24		
	22		
	20		
	18		

**Part Numbers System:**

CE = End Connector	→	CE
CT = Through Connector	→	
100 = 0.100" spacing (2.54 mm)	→	100
156 = 0.156" spacing (3.96 mm)	→	
F = Female	→	F
AWG Size (See above Table)	→	24
No. of circuits	→	12
Packaging quantity (Page 7)	→	D
R = Reels (available upon request)	→	
Contact Plating	→	.
Blank = Tin Plating	→	
B = 15µ" Gold over Nickel or Gold Flash over Palladium Nickel	→	





## Series CE/CT Connectors .100"

**.100" (2.54 mm) End and  
Through Connectors  
Available in 2-28 Circuits  
with Optional Cover**

RoHS  
Compliant

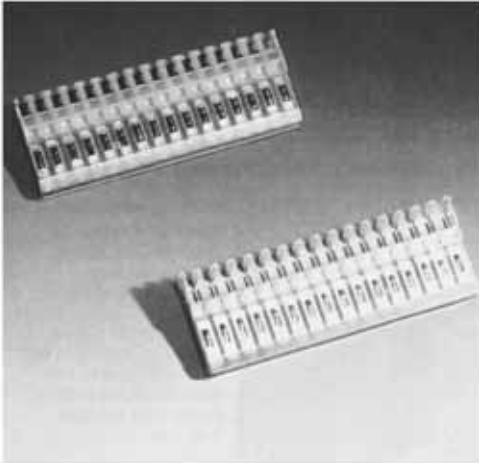

### Dimensions

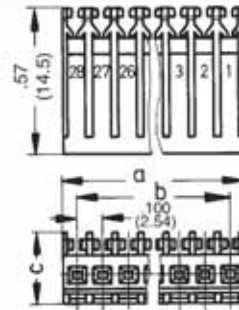

### Snap-on Covers EC

### Snap-on Covers TC



### Strain Relief Combination Cover SCC



### Dimensions - Dual Dims

No. of Circuits	2	3	4	5	6	7	8	9	10	11	12	13	14	15	16	17	18	19	20	21	22	23	24	25	26	27	28		
Dim. in	a	.200 (5.08)	.300 (7.62)	.400 (10.16)	.500 (12.70)	.600 (15.24)	.700 (17.78)	.800 (20.32)	.900 (22.86)	1.000 (25.40)	1.100 (27.94)	1.200 (30.48)	1.300 (33.02)	1.400 (35.56)	1.500 (38.10)	1.600 (40.64)	1.700 (43.18)	1.800 (45.72)	1.900 (48.25)	2.000 (50.80)	2.100 (53.34)	2.200 (55.88)	2.300 (58.42)	2.400 (60.96)	2.500 (63.50)	2.600 (66.04)	2.700 (68.58)	2.800 (71.12)	
in. / (mm)	b	.100 (2.54)	.200 (5.08)	.300 (7.62)	.400 (10.16)	.500 (12.70)	.600 (15.24)	.700 (17.78)	.800 (20.32)	.900 (22.86)	1.000 (25.40)	1.100 (27.94)	1.200 (30.48)	1.300 (33.02)	1.400 (35.56)	1.500 (38.10)	1.600 (40.64)	1.700 (43.18)	1.800 (45.72)	1.900 (48.25)	2.000 (50.80)	2.100 (53.34)	2.200 (55.88)	2.300 (58.42)	2.400 (60.96)	2.500 (63.50)	2.600 (66.04)	2.700 (68.58)	2.800 (71.12)

No. of Circuits 2-28 \*(Contact Factory For Circuit Availability)

□□ = Number of Circuits

Version	Wire Size				Dimension c inches (mm)
	AWG 28	AWG 26	AWG 24	AWG 22	
End Connector	CE100F28-□□	CE100F26-□□	CE100F24-□□	CE100F22-□□	.27 (6.9)
Through Connector	CT100F28-□□	CT100F26-□□	CT100F24-□□	CT100F22-□□	.30 (7.6)
AWG Identification Color	Green	Blue	Black	Red	

Snap-on Cover for End connectors

EC 100F-□□

Snap-on Cover for Through connectors

TC 100F-□□

Strain Relief Combination Cover

SCC100F-□□

**Headers**

**Mass Terminated Connector System Male Headers Mate With Female Connectors**

**Headers/Part Numbers System:**

\*MAS-CON headers are breakable molded wafers, dimensionally more accurate than extruded, proven to be very cost effective for prototyping or small production runs.

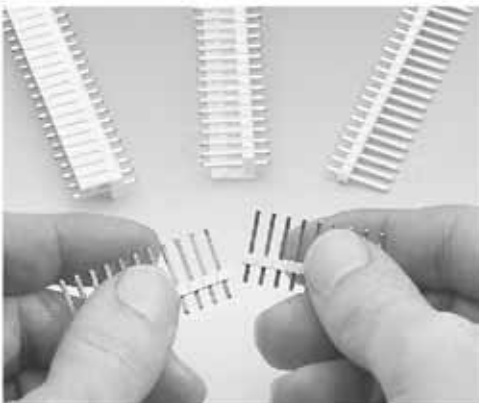

**Part Numbers System:**

M	= Male	→	M
F	= Standard	→	F
L*	= Locking		
P	= Polarizing		
T	= Tab Polarized		
S	= Straight Post	→	S
A	= Angled Post	→	S
S	= Square Pin	→	S
100	= 0.100" spacing (2.54 mm)	→	100
156	= 0.156" spacing (3.96 mm)		
No. of circuits (See table below)		→	10
Packaging quantity (See table below)		→	D
Contact Plating		→	.
Blank	= Tin Plating		
B	= 15μ" min Gold or Gold Flash over Palladium		

**Packaging Quantity**

Spacing	No. of Circuits	Spacing	No. of Circuits	Standard Packs	
				Code	Qty Pcs.
0.100" (2.54 mm)	2 – 5	0.156" (3.96 mm)	2 – 5	D	500
	6 – 36		6 – 24	C	100

\*For MLSS100 and MLAS100 - Circuits 2-12 and 14 positions are solid black wall and are not breakable.



## Series MF/ML/MP .100" Headers

**.100" (2.54 mm) Headers  
Available in 2-36 Circuits**

**RoHS  
Compliant**

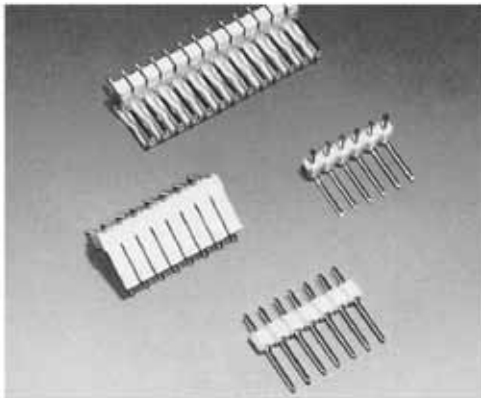

### Right Angled MFAS...

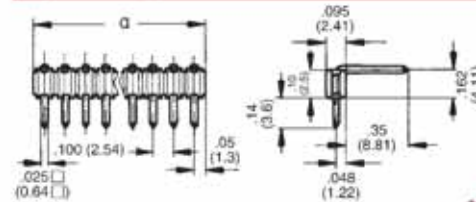

**\*Slotted Back Wall: 13 and 15-36 Circuits**

### Right Angled Locking MLAS

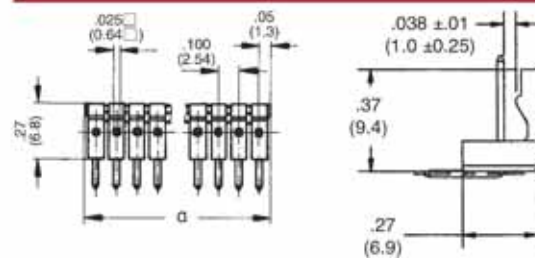

### Straight MFSS...

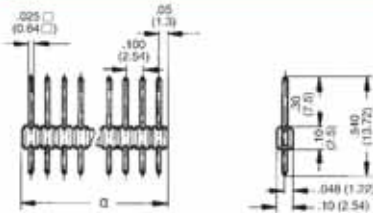

### Right Angled Polarizing MPAS...

### Printed Circuit Layout...

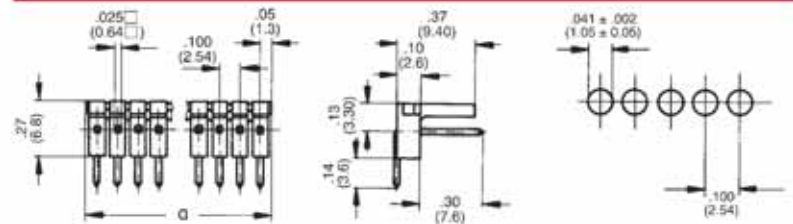

### Straight, Locking MLSS...

**\*Slotted Back Wall: 13 and 15-36 Circuits**

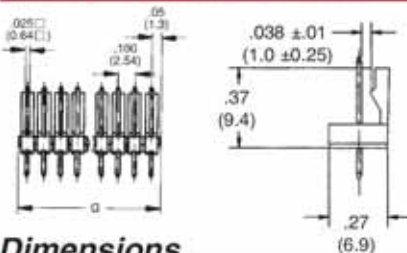

### Straight, Polarizing MPSS...

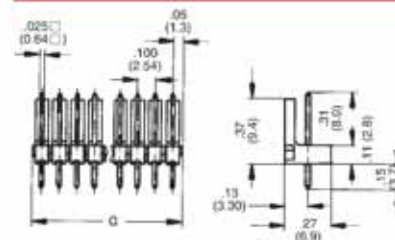

### Dimensions

No. of Circuits	2	3	4	5	6	7	8	9	10	11	12	13	14	15	16	17	18	19	20	21	22	23	24	25	26	27	28	29	30	31	32	33	34	35	36
Dimensions	.200 (5.08)	.300 (7.62)	.400 (10.16)	.500 (12.70)	.600 (15.24)	.700 (17.78)	.800 (20.32)	.900 (22.86)	1.000 (25.40)	1.100 (27.94)	1.200 (30.48)	1.300 (33.02)	1.400 (35.56)	1.500 (38.10)	1.600 (40.64)	1.700 (43.18)	1.800 (45.72)	1.900 (48.26)	2.000 (50.80)	2.100 (53.34)	2.200 (55.88)	2.300 (58.42)	2.400 (60.96)	2.500 (63.50)	2.600 (66.04)	2.700 (68.58)	2.800 (71.12)	2.900 (73.66)	3.000 (76.20)	3.100 (78.74)	3.200 (81.28)	3.300 (83.82)	3.400 (86.36)	3.500 (88.90)	3.600 (91.44)

### Part Number

No. of Circuits 2-36 (Contact Factory For Circuit Availability) <span style="float: right;">□ = Number of Circuits</span>					
Description					
Straight MFSS100- □□	Straight Locking MLSS100- □□	Straight Polarizing MPSS100- □□	Angled MFAS100- □□	Angled Locking MLAS100- □□	Angled Polarizing MPAS100- □□

For MTSS100 and MTAS100 - Circuits 2-12 and 14 - See Page 11

**Series CEP/CTP  
Polarized  
Connectors**

**.100" (2.54 mm) End and  
Through Connectors  
Available in 2-28 Circuits  
with Optional Cover**

**RoHS  
Compliant**



**Dimensions**

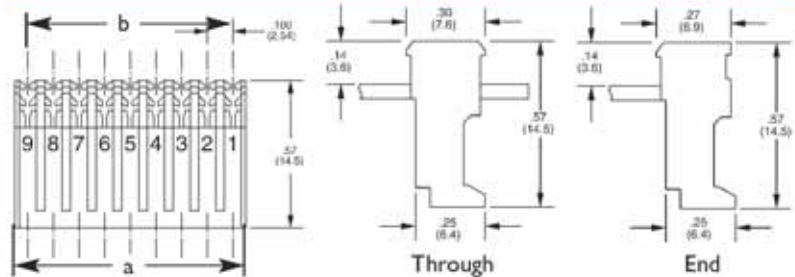

**Snap-on Covers EC**

**Snap-on Covers TC**

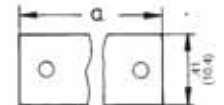
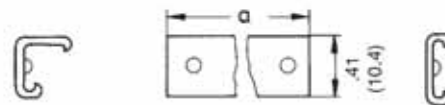

**Strain Relief Combination Cover SCC**



**Dimensions - Dual Dims**

No. of Circuits	2	3	4	5	6	7	8	9	10	11	12	13	14	15	16	17	18	19	20	21	22	23	24	25	26	27	28		
Dim. in in. / (mm)	a	.200 (5.08)	.300 (7.62)	.400 (10.16)	.500 (12.70)	.600 (15.24)	.700 (17.78)	.800 (20.32)	.900 (22.86)	1.000 (25.40)	1.100 (27.94)	1.200 (30.48)	1.300 (33.02)	1.400 (35.56)	1.500 (38.10)	1.600 (40.64)	1.700 (43.18)	1.800 (45.72)	1.900 (48.25)	2.000 (50.80)	2.100 (53.34)	2.200 (55.88)	2.300 (58.42)	2.400 (60.96)	2.500 (63.50)	2.600 (66.04)	2.700 (68.58)	2.800 (71.12)	
	b	.100 (2.54)	.150 (3.81)	.200 (5.08)	.250 (6.35)	.300 (7.62)	.350 (8.89)	.400 (10.16)	.450 (11.43)	.500 (12.70)	.550 (13.97)	.600 (15.24)	.650 (16.51)	.700 (17.78)	.750 (19.05)	.800 (20.32)	.850 (21.59)	.900 (22.86)	.950 (24.13)	1.000 (25.40)	1.050 (26.67)	1.100 (27.94)	1.150 (29.21)	1.200 (30.48)	1.250 (31.75)	1.300 (33.02)	1.350 (34.29)	1.400 (35.56)	1.450 (36.83)

**Part Number**

No. of Circuits	2-28 (Contact Factory For Circuit Availability)				□□ = Number of Circuits			
Version	Wire Size							
	AWG 28		AWG 26		AWG 24		AWG 22	
End Connector	CEP100F28-□□		CEP100F26-□□		CEP100F24-□□		CEP100F22-□□	
Through Connector	CTP100F28-□□		CTP100F26-□□		CTP100F24-□□		CTP100F22-□□	
AWG Identification Color	Green		Blue		Black		Red	
Snap-on Cover for End connectors	EC 100F-□□							
Snap-on Cover for Through connectors	TC 100F-□□							
Strain Relief Combination Cover	SCC100F-□□							



**Series MTSS/MTAS  
Tab Polarized  
Headers**

**.100" (2.54 mm) Headers  
Available in 2-12,  
14 Circuits**

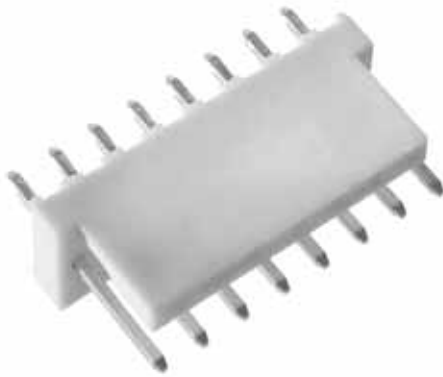

**Dimensions**

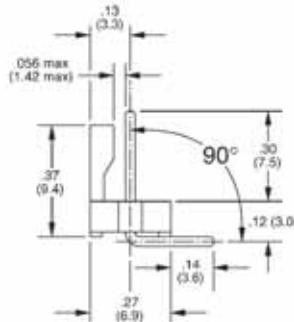

**MTAS 100**

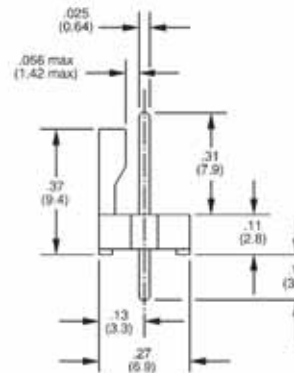

**MTSS 100**

**Dimensions**

No. of Circuits	2	3	4	5	6	7	8	9	10	11	12	14
Dimensions in mm <sup>a</sup>	.200 (5.08)	.300 (7.62)	.400 (10.16)	.500 (12.70)	.600 (15.24)	.700 (17.78)	.800 (20.32)	.900 (22.86)	1.000 (25.40)	1.100 (27.94)	1.200 (30.48)	1.400 (35.56)

**Part Number**

No. of Circuits 2-12, 14 (Contact Factory For Other Circuit Availability)		□□ = Number of Circuits	
<b>Description</b>			
Straight Polarizing		Angled Polarizing	
<b>MTSS100-□□</b>		<b>MTAS100-□□</b>	

**Series CE/CT  
.156" Connectors**

**.156" (3.96 mm) End and  
Through Connectors  
Available in 2-24 Circuits  
with Optional Cover**

**RoHS  
Compliant**

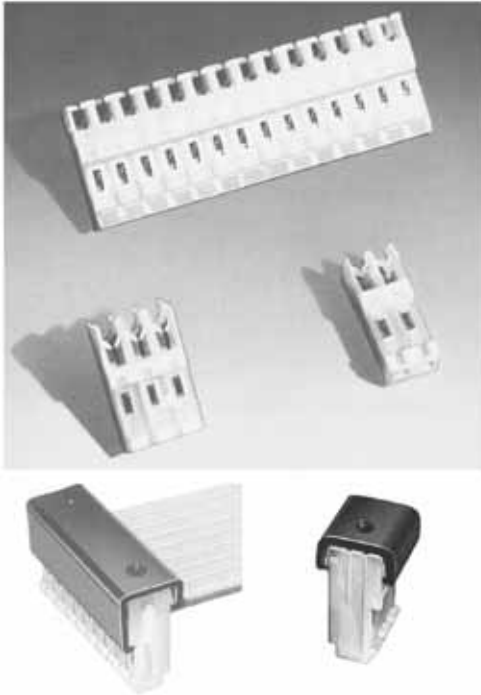

**Dimensions**

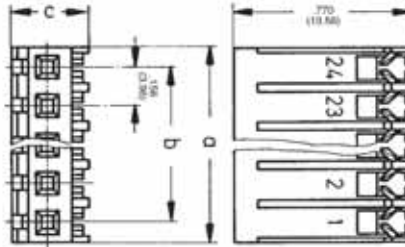

**Snap-on Covers EC**

**Snap-on Covers TC**



**Strain Relief Combination Cover SCC**



**Dimensions**

No. of Circuits	2	3	4	5	6	7	8	9	10	11	12	13	14	15	16	17	18	19	20	21	22	23	24	
Dim. in in. / (mm)	a	.312 (7.92)	.468 (11.89)	.624 (15.85)	.780 (19.81)	.936 (23.77)	1.092 (27.74)	1.248 (31.70)	1.404 (35.66)	1.560 (39.62)	1.716 (43.59)	1.872 (47.55)	2.028 (51.51)	2.184 (55.47)	2.340 (59.44)	2.496 (63.40)	2.652 (67.36)	2.808 (71.32)	2.964 (75.29)	3.120 (79.25)	3.276 (83.21)	3.432 (87.17)	3.588 (91.14)	3.744 (95.10)
	b	.156 (3.96)	.312 (7.92)	.468 (11.89)	.624 (15.85)	.780 (19.81)	.936 (23.77)	1.092 (27.74)	1.248 (31.70)	1.404 (35.66)	1.560 (39.62)	1.716 (43.59)	1.872 (47.55)	2.028 (51.51)	2.184 (55.47)	2.340 (59.44)	2.496 (63.40)	2.652 (67.36)	2.808 (71.32)	2.964 (75.29)	3.120 (79.25)	3.276 (83.21)	3.432 (87.17)	3.588 (91.14)

**Part Number**

No. of Circuits	2-24 (Contact Factory For Circuit Availability)				□□ = Number of Circuits
Version	Wire Size				Dimensions
	AWG 24	AWG 22	AWG 20	AWG 18	
End Connector	CE156F24-□□	CE156F22-□□	CE156F20-□□	CE156F18-□□	.33 (8.4)
Through Connector	CT156F24-□□	CT156F22-□□	CT156F20-□□	CT156F18-□□	.35 (9.0)
AWG Identification Color	Black	Red	Brown	Orange	
Snap-on Cover for End connectors					EC 156F-□□
Snap-on Cover for Through connectors					TC 156F-□□
Strain Relief Combination Cover					SCC156F-□□



**Series CEP/CTP  
.156" Connectors**

**.156" (3.96 mm) End and  
Through Connectors  
Available in 2-24 Circuits  
with Optional Cover**

**RoHS  
Compliant**



**Dimensions**

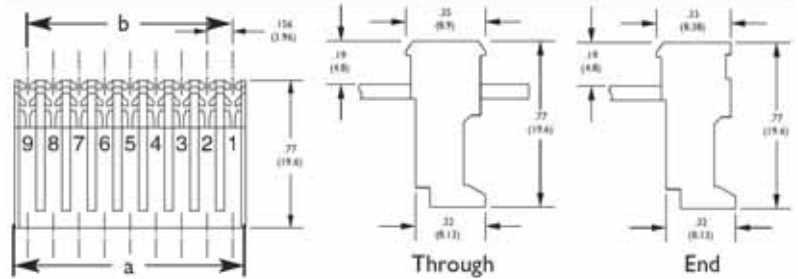

**Snap-on Covers EC**

**Snap-on Covers TC**



**Strain Relief Combination Cover SCC**



**Dimensions**

No. of Circuits	2	3	4	5	6	7	8	9	10	11	12										
Dim. in in. / (mm)	a	.312 (7.92)	.468 (11.89)	.624 (15.85)	.780 (19.81)	.936 (23.77)	1.092 (27.74)	1.248 (31.70)	1.404 (35.66)	1.560 (39.62)	1.716 (43.59)	1.872 (47.55)									
	b	.156 (3.96)	.312 (7.92)	.468 (11.89)	.624 (15.85)	.780 (19.81)	.936 (23.77)	1.092 (27.74)	1.248 (31.70)	1.404 (35.66)	1.560 (39.62)	1.716 (43.59)	1.872 (47.55)								

**Part Number**

No. of Circuits	2-24 (Contact Factory For Circuit Availability)				□□ = Number of Circuits
Version	Wire Size				
	AWG 24	AWG 22	AWG 20	AWG 18	
End Connector	CEP156F24-□□	CEP156F22-□□	CEP156F20-□□	CEP156F18-□□	
Through Connector	CTP156F24-□□	CTP156F22-□□	CTP156F20-□□	CTP156F18-□□	
AWG Identification Color	Black	Red	Brown	Orange	
Snap-on Cover for End connectors					EC 156F-□□
Snap-on Cover for Through connectors					TC 156F-□□
Strain Relief Combination Cover					SCC156F-□□

## Series CEH/CTH High Power Connectors

**.156" (3.96 mm) End and  
Through Hi-Power  
Connectors Available in 2-12  
Circuits with Optional Cover**

RoHS  
Compliant

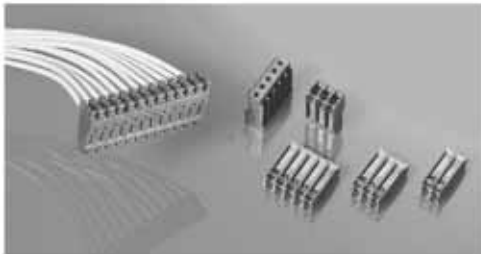

- Provides high current capacity, **18AWG - 12.5 A (75° C)**
- Dimpled contact increases hertz stress
- UL 94V-0 rated black housing

### Dimensions

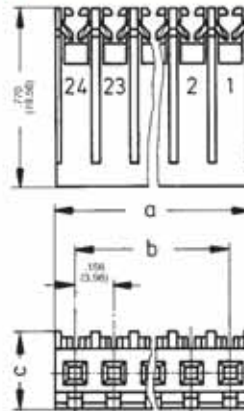

### Snap-on Covers EC



### Strain Relief Combination Cover SCC



### Dimensions

No. of Circuits	2	3	4	5	6	7	8	9	10	11	12	
Dim. in in. / (mm)	a	.312 (7.92)	.468 (11.89)	.624 (15.85)	.780 (19.81)	.936 (23.77)	1.092 (27.74)	1.248 (31.70)	1.404 (35.66)	1.560 (39.62)	1.716 (43.59)	1.872 (47.55)
	b	.156 (3.96)	.312 (7.92)	.468 (11.89)	.624 (15.85)	.780 (19.81)	.936 (23.77)	1.092 (27.74)	1.248 (31.70)	1.404 (35.66)	1.560 (39.62)	1.716 (43.59)

### Part Number

No. of Circuits 2-12 (Contact Factory For Circuit Availability)		□□ = Number of Circuits
Version	Wire Size	Dimensions
	AWG 18 (0.8 - 0.9 mm <sup>2</sup> )	c inches (mm)
End Connector	CEH156F18- □□	.33 (8.4)
Through Connector	CTH156F18- □□	.35 (9.0)
AWG Identification	none	
Snap-on Cover for End connectors		EC 156F- □□
Strain Relief Combination Cover		SCC156F- □□

**Series MF/ML/MT  
.156" Headers**

**.156" (3.96 mm) Headers  
Available in 2-24 Circuits**

RoHS  
Compliant

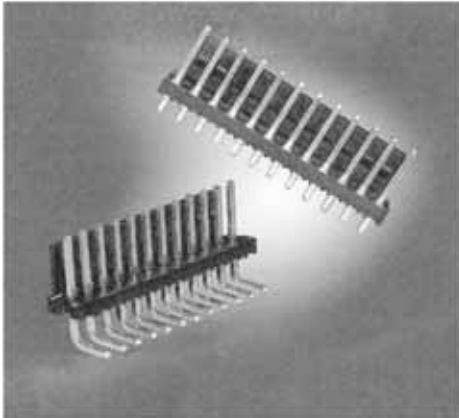

**Right Angled Flat MFAS... 2-24 circuits**

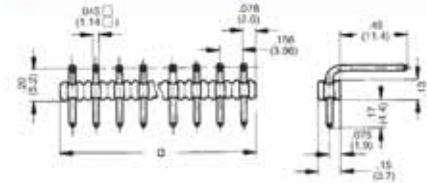

**Right Angled, Locking MLAS... 2-24 circuits**

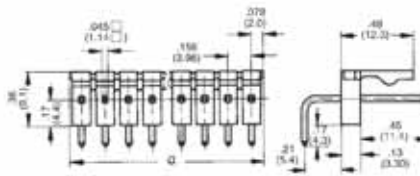

**Right Angled, Tab Polarized MTAS... 2-12 circuits**

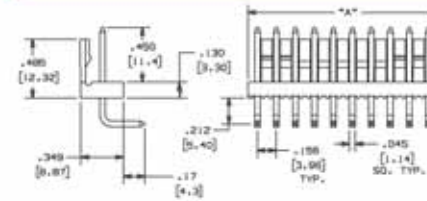

**Straight MFSS... 2-24 circuits**

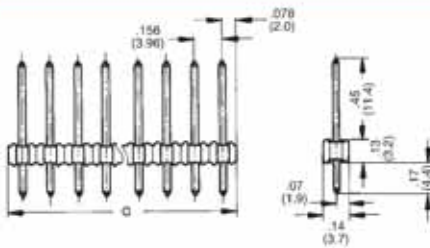

**Straight Tab Polarized MTSS... 2-12 circuits**

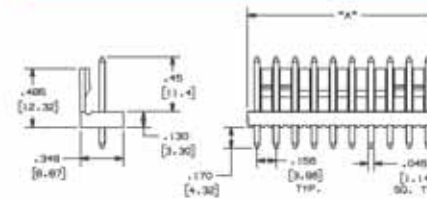

**Straight, Locking MLSS... 2-24 circuits**

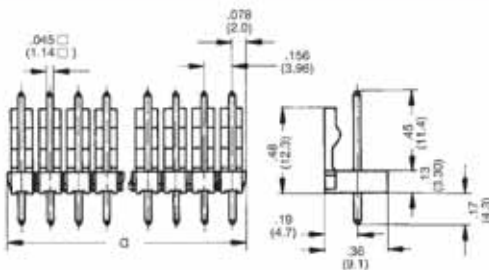

**Printed Circuit layout...**

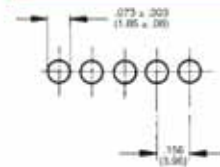

**Dimensions**

No. of Circuits	2	3	4	5	6	7	8	9	10	11	12	13	14	15	16	17	18	19	20	21	22	23	24
Dimensions	.312 (7.92)	.468 (11.89)	.624 (15.85)	.780 (19.81)	.936 (23.77)	1.092 (27.74)	1.248 (31.70)	1.404 (35.66)	1.560 (39.62)	1.716 (43.59)	1.872 (47.55)	2.028 (51.51)	2.184 (55.47)	2.340 (59.44)	2.496 (63.40)	2.652 (67.36)	2.808 (71.32)	2.964 (75.29)	3.120 (79.25)	3.276 (83.21)	3.432 (87.17)	3.588 (91.14)	3.744 (95.10)

**Part Number** (Contact Factory For Circuit Availability)

No. of Circuits	2, 3, 4, 5, 6, 7, 8, 9, 10, 11, 12, 13, 14, 15, 16, 17, 18, 19, 20, 21, 22, 23, 24																								□□ = Number of Circuits
Version	Style																								
Square Post	Straight	Straight Locking	Straight Tab Polarized	Angled	Angled Locking	Angled Tab Polarized																			
	MFSS156-□□	MLSS156-□□	MTSS156-□□	MFAS156-□□	MLAS156-□□	MTAS156-□□																			



**Flat headers With Custom Length Pins**

Pancon Connectors is pleased to introduce Mas-Con Flat Headers with Custom length pins. These headers have .100" spacing between circuits and mate with Mas-Con IDC connectors as well as similar industry standard connectors.

**Applications**

These Flat Headers with custom length pins can be mated with our standard Mas-Con IDC sockets or with a variety of other .100" pitch connectors. The custom lengths allow for a variety of uses in many industry standard applications. The break-to-length feature makes these headers extremely adaptable to many applications.

**Features**

Custom length pins allow for a variety of mating applications. The header wafer is breakable, allowing for greater flexibility and less inventory. High quality copper alloy pins can be plated in tin or gold. Available in straight or right angle styles.

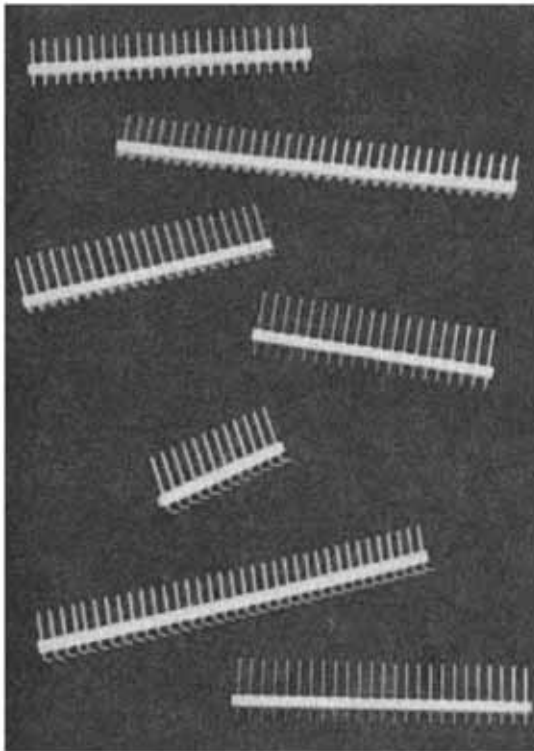

**PART NUMBER SYSTEM**

F T 100 - 36 - 240 120

FLAT HEADER

PLATING T=Tin  
B=Gold 15μ" or Gold Flash over Palladium  
G=Gold 10μ"  
F=Gold Flash

SPACING .100"

STYLE (-) STRAIGHT PINS  
(A) ANGLED PINS

TAIL LENGTH = .120" - .140"

MATING LENGTH  
STRAIGHT = .105" - .685"  
ANGLED = .105" - .318"

NO. OF CIRCUITS (2-36)

Contact factory for part availability

**Flat headers With Custom Length Pins**

**RoHS Compliant**

**MATERIALS**

**Housing**  
Glass Filled Polyester

**Plating**  
150µ" Tin over Nickel  
15µ" Gold over Nickel  
or Gold Flash over Palladium

**Flammability**  
UL 94 V-0

**Pin**  
Copper Alloy

**PRODUCT DIMENSIONS - Right Angle Pins**

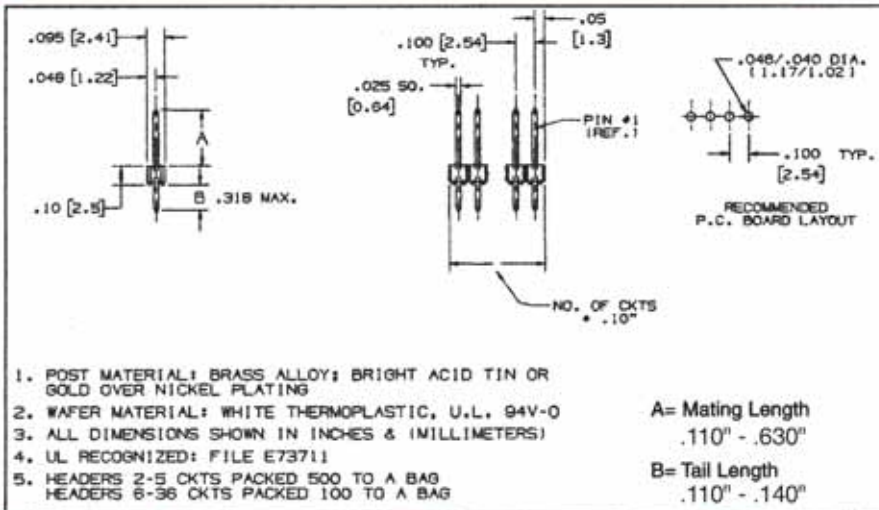

\*Lengths A+B must total at least .220", be no greater than .770", and must be in multiples of .010".

**PRODUCT DIMENSIONS - Straight Pins**

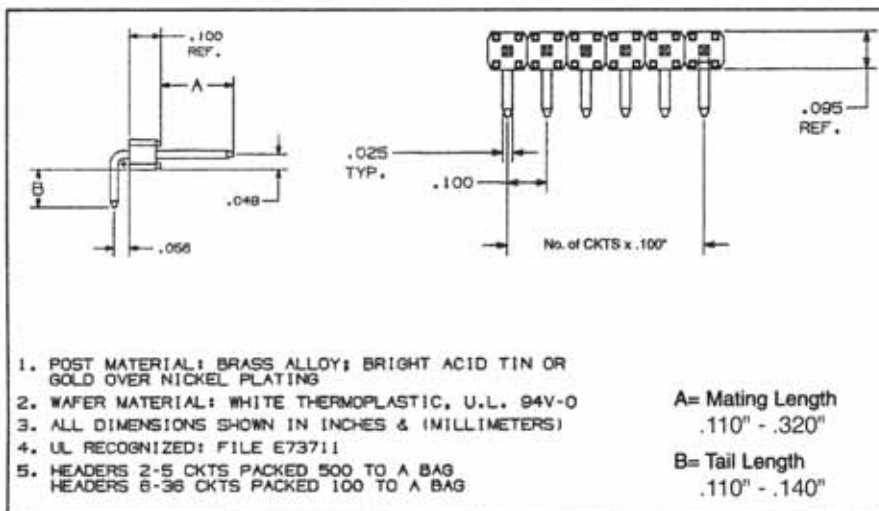

\*Lengths A+B must total at least .220", Be no greater than .460", and must be in multiples of .010".

**ELECTRICAL**

**Current Rating**  
4.0 Amps max. per pin

**Dielectric Withstanding Voltage**  
2.0 KVAC min.

**Insulation Resistance**  
5,000 Megaohms min.

**TEMPERATURE**

**Range**  
-67°F 221°F  
(-55°C to 105°C)

**MOUNTING**

**Recommended PCB thickness range**  
min 0.062" (1.6mm)  
max 0.125" (3.2 mm)

**Technical Data**

Spacing	Inches (mm)	.100" (2.54 mm)				.156" (3.96 mm)				.156" (3.96) Hi-Power
No. of Circuits		Female 2-28, Male 2-36				2-24				Hi-Power 2-12
Termination Method		Insulation Displacement Contact								
AWG Size	AWG	28	26	24	22	24	22	20	18	18
Outside Diameter Range	in (mm)	min. .030" (0.76) - max. .055" (1.4)				min. .040" (1.0) - max. .090" (2.28)				
Wire		Solid or stranded								
Recommended UL Type wire		UL style 1061/1095 MIL-W-1687 8				UL style 1007/1061/1095 MIL-W-1687 8D				
Polarization		Integral Polarization								
Coding		with Coding key (see page 19)								
Current Rating	A	see derating curve (below)								
Creepage and Clearance Distances	inches (mm)	.06" (1.6)				.10" (2.5)				
Voltage Rating	V	acc. to VDE 0110 b/2.79 table 4								
Temperature Range	°C	-67° F to 221° F (-55 C° to + 105C°) Connectors / -67° F to 221° F (-55 C° to + 105C°) Headers								
<b>Material</b>										
Contact Material Female		Copper Alloy								
Contact Plating Female		Bright Acid Tin or Gold over Nickel or Gold Flash over Palladium Nickel								
Housing Material Female		6/6 Nylon UL94-2				Heat Stabilized / Nylon, UL 94 V-0				
Contact Material Headers		Copper Alloy				High Tensile Copper Alloy				
Contact Plating Headers		Tin or Gold over Nickel or Gold Flash over Palladium								
Wafer Material Header		Thermoplastic UL 94 V-0								
Covers		EC & TCBlack Thermoplastic UL 94 V-0 EC & TC / SCC Natural Nylon 6/6 UL 94 V-2								

(Product Specifications Available Upon Request)

**Current Derating Curve Against Ambient Temperature.**

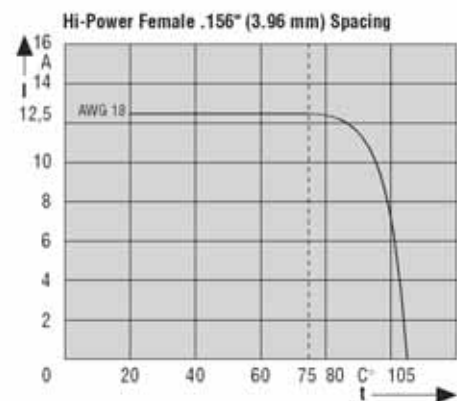
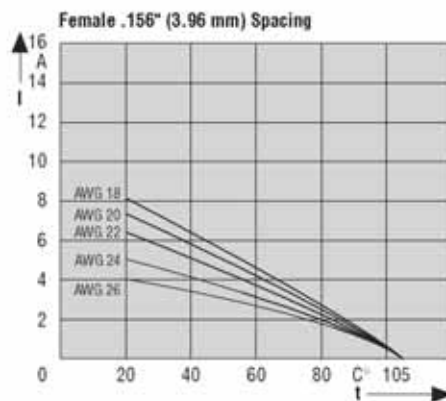
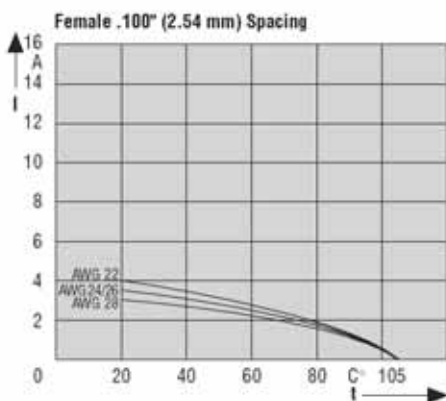



## Accessories

**RoHS  
Compliant**



### Polarizing Key

Polarizing keys assures correct orientation between connector and header. Carrier facilitates insertion and handling.

**Material:** Natural Nylon 6/6, UL94V-2

Version	Packaging Qty	Connector Spacing
PK 100-D	500	.100" (2.54 mm)
PK 156-D		.156" (3.96 mm)

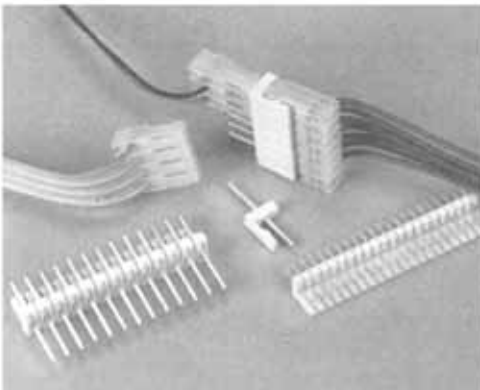

### In-Line Splice

- Forms an in-line splice, mating two Mas-Con female connectors.
- Locking feature built into side of the header.
- Breakable molded wafers are available in both .100 and 156 centerlines.

### Part Number System

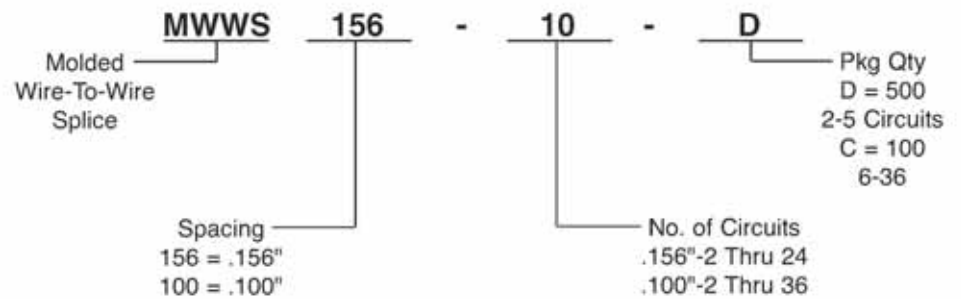

**Tooling****Hand Assembly Tools****Hand Tool MRT**

- Hand Tool – ideal for maintenance, repair or prototyping.
- Low Volume

Part No.	Connector Spacing
MRT-100F	.100" (2.54mm)
MRT-156F	.156" (3.96mm)

**Manual Tool MMIT**

- Terminates discrete wire into end and through connectors.
- Operator friendly
- Robust construction
- Low Volume

Part No.	Connector Spacing
MMIT-100F	.100" (2.54 mm)
MMIT-156F	.156" (3.96 mm)

**Tooling**

**Hand Assembly Tools**

**Manual Tool MCT**



- Lightweight – easy to use.
- Automatically indexes to next circuit position.
- Medium Volume

Part No.	Description
MCT*	Manual Hand Tool

\* For use with interchangeable nose sections – CTD.  
Order nose sections separately. (See page 21)

**Pneumatic Tool PCT**



- Operates on 85 PSI air pressure.
- Includes filter regulator and hose.

Part No.	Description
PCT*	Pneumatic Hand Tool
PCT BM**	Bench Mount with Foot Pedal

\* For use with interchangeable nose sections – CTD.  
Order nose sections separately. (SEE BELOW)  
\*\* Does not include PCT Tool



**Interchangeable Nose Section CTD**

- For End connectors – type CE, CEH, CEP
- For single wire.
- For use with discrete wire.
- Use with MCT, PCT or PCTBM Tools.

Part No.	Spacing	Tool
CTD-100F	.100" (2.54 mm)	MCT, PCT
CTD-156F	.156" (3.96 mm)	MCT, PCT



**Tooling****Termination Tools****Manual Tool**

- for use with discrete wire
- controlled cycle head automatically indexes to next circuit position
- connectors can be loaded at any point in feed track
- operated by foot pedal

Part No.	Description
ECT	Motor, track and foot pedal
ECT-100F	.100" (2.54 mm) termination nose and track insert
ECT-156F	.156" (3.96 mm) termination nose and track insert

**Tooling**

**On-Board Harness System for High Volume Requirements**

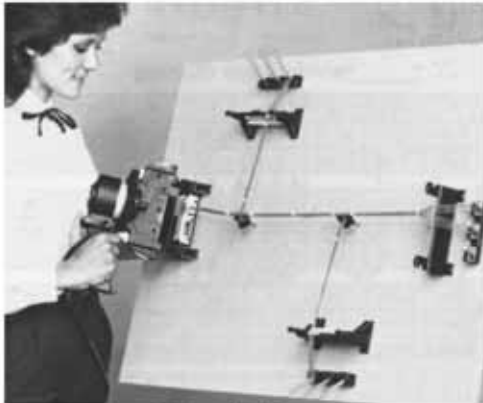

**Pneumatic harness board hand tool for MAS-CON End and Through – PPHT**

Connectors in 2.54 mm and 3.96 mm spacing. Lightest tool in the industry. Connectors are snapped into the fixtures, the harness is constructed by inserting wires into retention fingers of each circuit, apply the PPHT tool to each fixture and mass terminate in one operation. For use with discrete wire and flat cable applications.

Part No.	Spacing	Description	Color	Weight
PPHT-100F	.100" (2.54 mm)	Pneumatic Hand Tool	Red	2.9 lbs (1.3 kg)
PPHT-156F	.156" (3.96 mm)		White	2.9 lbs (1.3 kg)

**Harness Board Fixtures**

Harness board fixtures hold connectors in place and provide locking posts for the PPHT tool during termination. The two piece fixture/base concept provides maximum utilization of your harness system investment.  
**FE** – End Connector, cuts off wire flush  
**FT** – Through Connector, no cut off  
**FC** – Through Connector, selection cut off

Description	for End connectors cut off		For Through connectors no cut off		For Through connectors select cut off	
Spacing	.100" (2.54 mm)	.156" (3.96 mm)	.100" (2.54 mm)	.156" (3.96 mm)	.100" (2.54 mm)	.156" (3.96 mm)
Fixture with base	<b>PPHT-100FE</b>	<b>PPHT-156FE</b>	<b>PPHT-100FT</b>	<b>PPHT-156FT</b>	<b>PPHT-100FC</b>	<b>PPHT-156FC</b>



**Bases for Mounting Fixtures**

Extra bases (two provided with each fixture). Boards can be prepared with these low cost bases in place and stored. Each board is then ready for instant installation of fixtures to meet current production requirements.

Part Number	Packaging Qty
CP11029C01	1 each

**Packaging Reel**

**.100"  $\phi$  End Connectors Reels  
Packaging — Type CE**

**.100" Series**

End Connectors Reel Packaging – Type CE and CETL, Pieces per Reel

High-volume reel-fed system, capable of approximately 2000 termination per hour.

No. of Circuits	Connector quantity	No. of Circuits	Connector quantity
2	5000	16	425
3	3500	17	400
4	2625	18	375
5	2100	19	350
6	1750	20	350
7	1500	21	325
8	1300	22	300
9	1150	23	300
10	1050	24	275
11	950	25	275
12	875	26	250
13	800	27	250
14	750	28	250
15	700		

Part No. Example: CE100F22-5-R

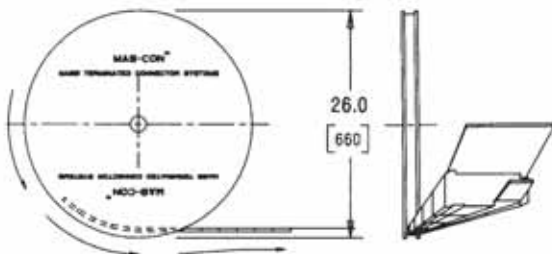
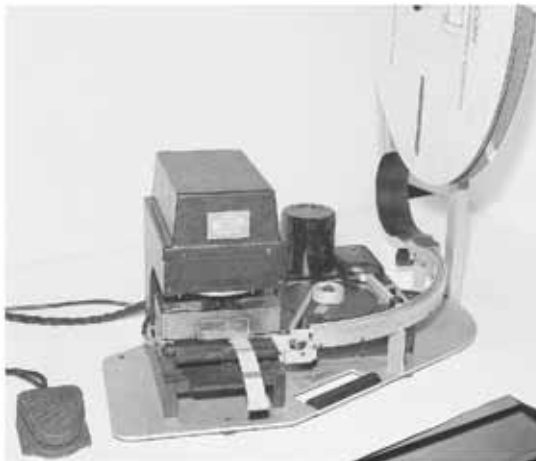





**PAN-FLEX™ Flat Cable**

- in 2.54 mm and 3.96 mm spacing with color identification circuit position 1.
- flexible PVC coated cable, tinned (7 strands) to UL style 2651.
- PVC insulation – grey RAL 7032
- Temperature Range -20° / +105° C
- U.L. Flammability VW-1

**Part Number**

No. of Circuits	2 – 28			2 – 24		
Flat cable	.100", (2.54 mm)			.156", (3.96 mm)		
Version	AWG 22	AWG 24	AWG 26	AWG18	AWG 20	AWG 22
Non pre-bonded**	100F22V □□CR*	100F24V □□CR*	100F26V □□CR*	156F18V □□CR*	156F20V □□CR*	156F22V □□CR*
Pre-bonded***	100PF22V □□CR*	100PF24V □□CR*	100PF26V □□CR*			
Color Code	Red	Black	Blue	orange	Brown	Red



- \* Roll length = CR = 100 ft (6-24 Ckt) DR = 500 ft (2-5 Ckt)
- \*\* designed for connector/connector applications
- \*\*\* designed for connector/board applications (no pre-tinning necessary)
- AWG 18, No. of conductors 2 to 16
- Complete part number with number of circuits

Notch inches (mm)  
 .100 (2.54 mm) .625 (15.88)  
 .156 (3.96 mm) .700 (17.78)

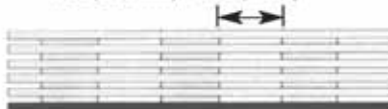

Increments N1 to N12 ▶ | ◀

**Part Number Example**

- Available in increments of 1" (25.4 mm) spacing to 12" (304.8 mm) spacing, with only one spacing interval per roll.
- Other notched spacing intervals available upon request.

N1	=	1" (25.4 mm)
N2	=	2" (50.8 mm)
N3	=	3" (76.2 mm)
N11	=	11" (279.4 mm)
N12	=	12" (304.8 mm)

100PF24V □□N3-CR ↑

□□= Number of Circuits

## Press-In Header in Press-In technique

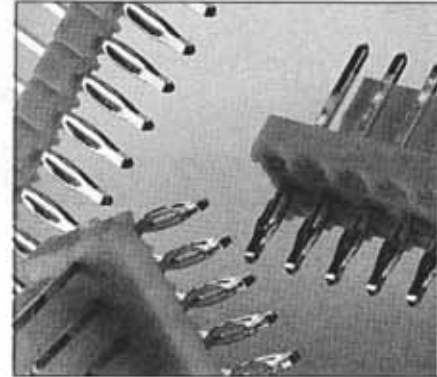

- Contact design of compliant pin: Eye-of-the-needle
- Two beams for unidirectional flexing
- Male Connections with right angle and straight pins
- Termination tools

### Features of the Press-In Technique

- Gas tight connection, resistant for gas, corrosion and vibration
- Low contact resistance
- No thermal load on PCIs
- Visible wiring
- Part loaded possible
- No "dry" joints

### Press-fit technique

P.C.B thickness	<b>A</b>	1,6 – 3,2 mm
drill size	<b>B</b>	1,15 <sup>+0.03</sup> mm
finished hole size	<b>C</b>	0,94 – 1,09 mm
complete	<b>D</b>	1,65 mm
copper		25 – 76µm
tin-lead		5 – 15 µm min.

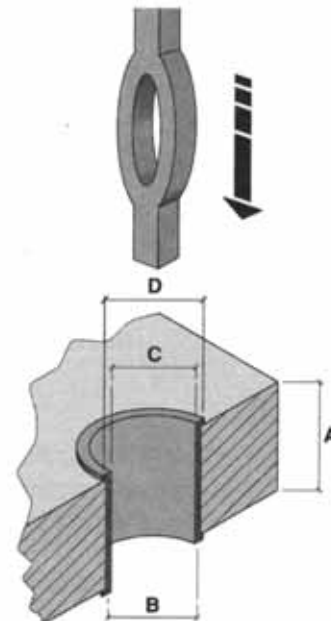

### Insertion and retention Forces – for various drill sizes –

(Forces initially in board of 1,6 – 3,2 mm thickness)

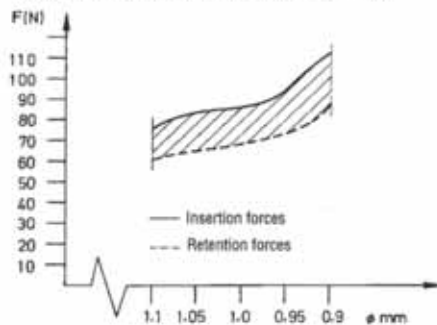

### MINIMUM (∅ 0,94 mm)

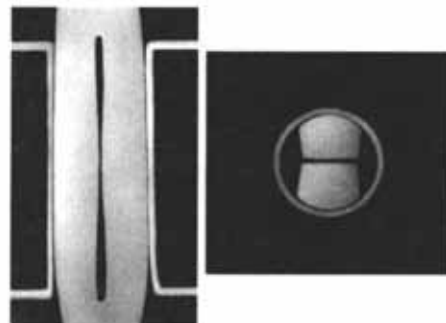

### MAXIMUM (∅ 1,09 mm)

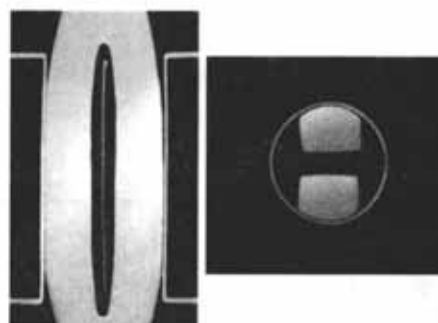

## Series MF/ML/MP 100 Press-in

**RoHS  
Compliant**

2.54  
mm  
.100"

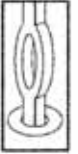

2.54 mm Headers with Locking and Polarizing available in 2 to 36 circuits

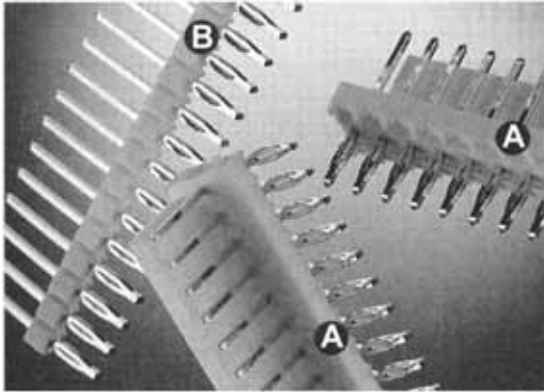

- A** 2 to 12 and 14 circuits, not breakable
- B** All other circuits breakable

**MLSP100...**  
Straight with Locking  
and Tab Polarization

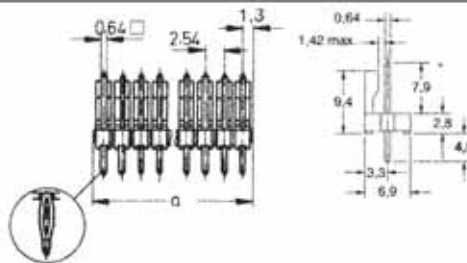

**MLAP100...**  
Angled Locking  
and Tab Polarizing

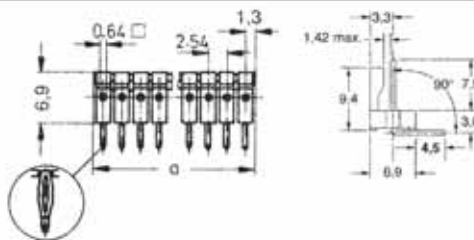

**MFSP100...**  
Straight

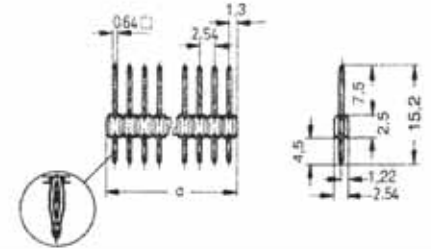

**MFAP100...<sup>#1</sup>**  
Angled

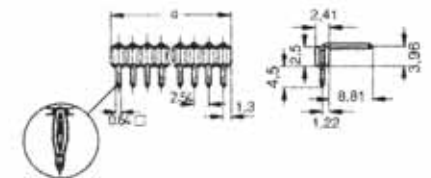

**MPSP100...**  
Straight Polarizing  
and Locking

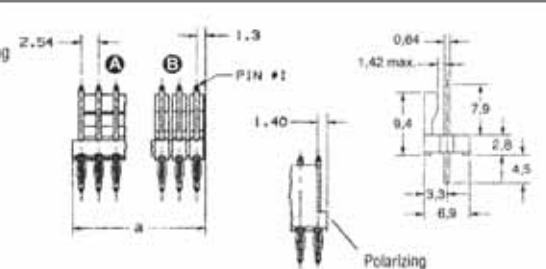

**MPAP100...**  
Angled Polarizing  
and Locking

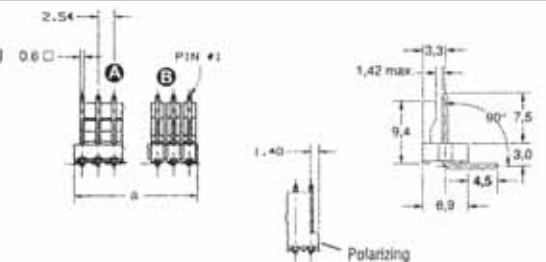

### Dimensions

	2	3	4	5	6	7	8	9	10	11	12	13	14	15	16	17	18	19	20	21	22	23	24	25	26	27	28	29	30	31	32	33	34	35	36
a	5.08	7.62	10.16	12.70	15a,24	17.78	20.32	22.86	25.40	27.94	30.48	33.02	35.56	38.10	40.64	43.18	45.72	48.26	50.80	53.34	55.88	58.42	60.96	63.50	66.04	68.58	71.12	73.66	76.20	78.74	81.28	83.82	86.36	88.90	91.44
	<b>A</b> Not Breakable											<b>B</b>	<b>A</b>	<b>B</b>	Breakable																				

### Part Number

No. of Circuits	2	3	4	5	6	7	8	9	10	11	12	13	14	15	16	17	18	19	20	21	22	23	24	25	26	27	28	29	30	31	32	33	34	35	36											
Description	Straight																																													
Description	Straight Locking and Tab Polarizing											Straight Polarizing											Angled						Angles Locking and Tab Polarizing						Angled Polarizing											
Part Number	MFSP100-□□											MLSP100-□□											MPSP100-□□						MFAP100-□□						MLAP100-□□						MPAP100-□□					

Contact Factory for Availability



## Part Number System

### MAS-CON® Header

Part number system:

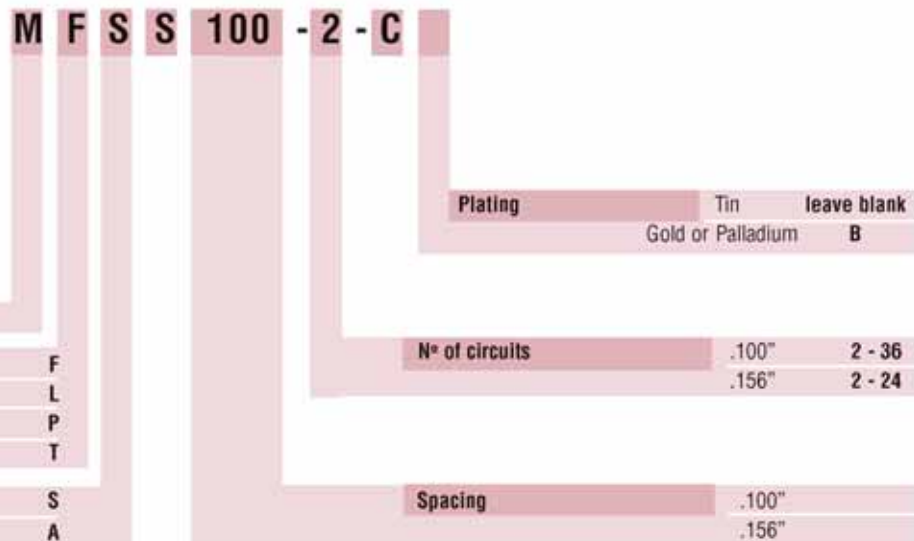

### MAS-CON® Insulation Displacement (IDC) connector

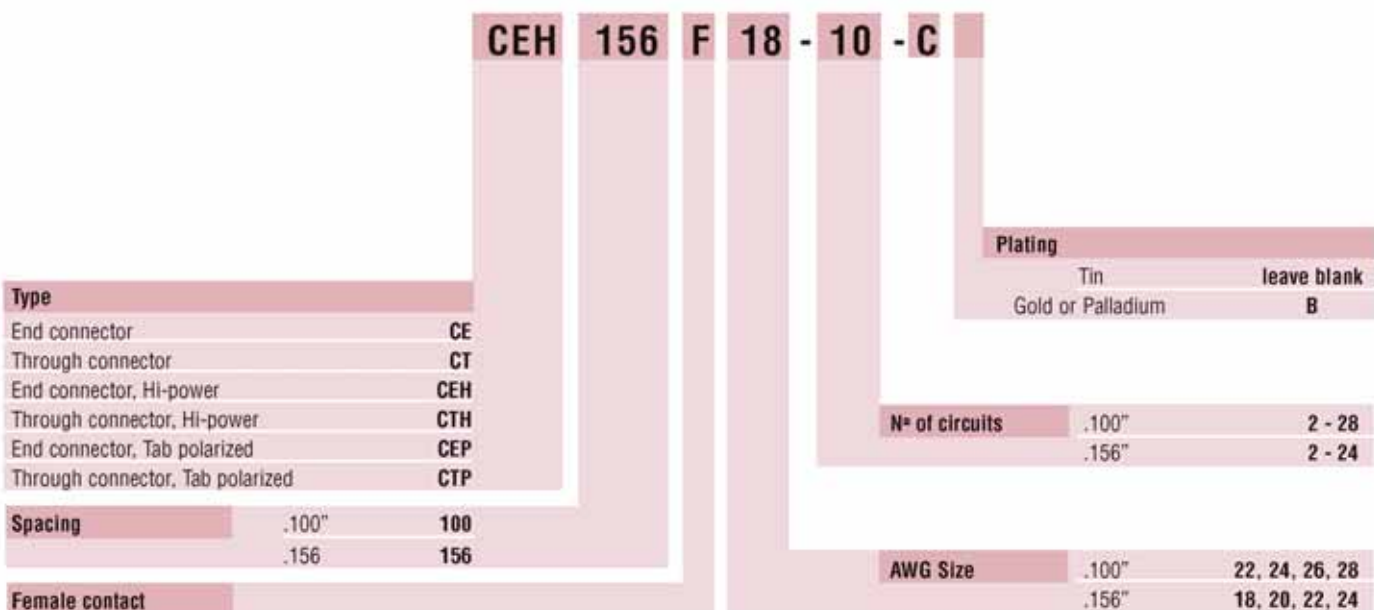

**Electronic Connectors**



**LAT-CON™**  
Flat Cable Connector System

**Flat Cable  
Connector  
System**

**One-Piece Lateral Entry  
IDC Socket**

- For Faster Termination
- For Daisy Chain Termination

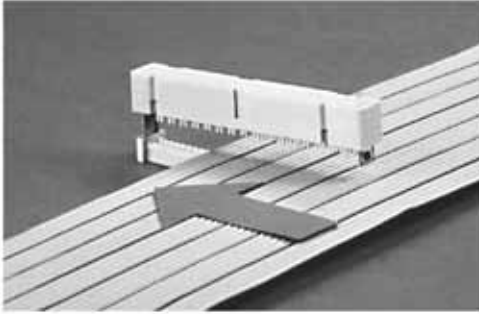

Series 050 – with strain relief bracket

Page  
33

Series 050 – Long locking lever

Page  
34,35

Series 057

Page  
36

Series 050 – Short locking lever

Page  
34,35

Series 050

Page  
33

Series 051

Page  
41

PAN-FLEX™ Flat Cable

Series 050

Page  
33

Series 050

Page  
34,35



## Flat Cable Connector System

Series 056 **Page 38**

Series 050 with strain relief bracket **Page 33**

Series 050 **Page 38**

Series 050 **Page 33**

Series 057 IDC Headers **Page 37**

Series 051 **Page 41**

Series 057 **Page 36**

Accessories ..... **Page 39, 40**

Tools ..... **Page 43, 44**

Cable ..... **Page 42**

D-Subminiature ID Metal Shell ..... **Page 45**

IDC Ribbon ..... **Page 46**

D-Subminiature PCB ..... **Page 47**

I.O. Connectors ..... **Page 48**

See page 49 for part number system

**Technical Data**

Series		050	056	051	057	057 IDC
Contact Spacing	Header	.100" (2.54 mm)				
	Socket	-				
Test Voltage $U_{rms}$	1000 V RMS					
Voltage Rating	acc. to VDE 0110					
Contact Resistance		$\leq 20\ m\ \Omega$	$\leq 20\ m\ \Omega$	-	-	$\leq 20\ m\ \Omega$
Creepage and Clearance Distance		0.7 mm min.	-	-	-	0.7 mm min.
Insulation Resistance	$\leq 10\ m\ \Omega$					
Temperature Range		-55°/+125°C		-55°/+125°C	-55°/+125°C	
Housings	Glass Filled Polyester					
Flammability Rating UL	94V-0					
Contact Material	Header	Copper Alloy	Copper Alloy			PhBr
	Socket	Copper Alloy		-	-	-
Socket Termination Method: acc. to DIN 41 611, Part 6		IDC-Method	-	-	-	IDC Method
Flat Cable UL-Style 2651 - 28 AWG / 26 AWG		Standard Wire		-	-	Standard Wire

Performance Level acc. to DIN 41 651	30 $\mu$ " Au or Gold Flash over Palladium Nickel	200 min.	Mating Cycles
	15 $\mu$ " Au or Gold Flash over Palladium Nickel	50 min.	

Operating current per contract related to ambient temperature:

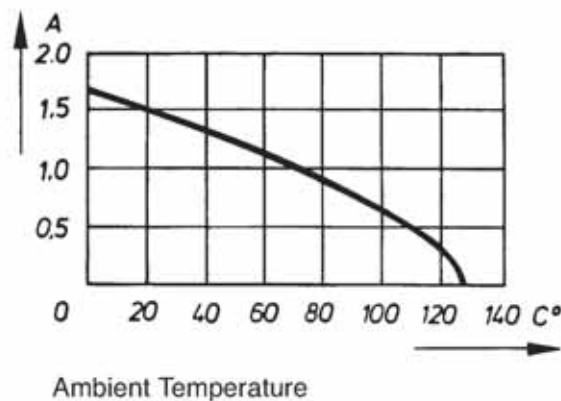

## Series 050 Sockets

6 to 64 contact sockets  
compatible with:  
**Din 41651,  
MIL-C-83503**

RoHS  
Compliant

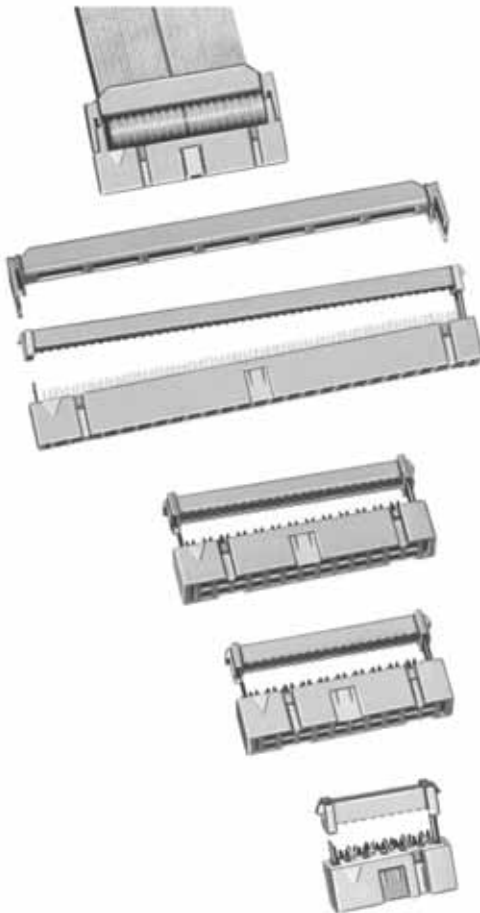

### Without Strain Relief

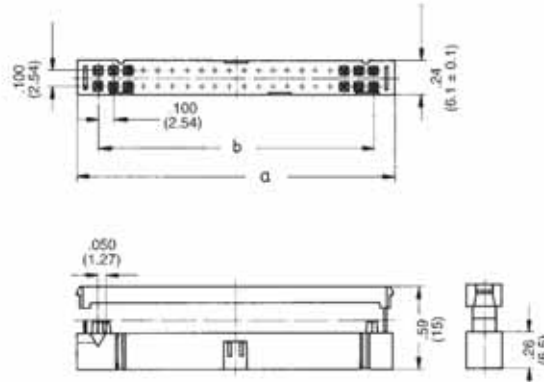

### With Strain Relief Bracket - Optional

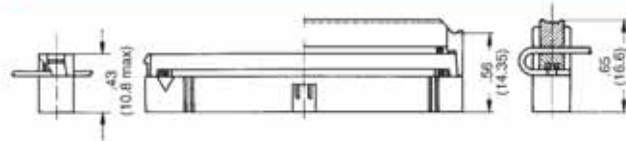

### Dimensions

	6	10	14	16	20	26	34	40	50	60	64
a	.48" (12.2)	.68" (17.3)	.88" (22.4)	.98" (24.9)	1.18" (30.0)	1.48" (37.6)	1.88 (47.8)	2.18" (55.4)	2.68" (68.1)	3.18" (80.8)	3.38" (85.9)
b	.200" (5.08)	.400" (10.16)	.600" (15.24)	.700" (17.78)	.900" (22.86)	1.200" (30.48)	1.600" (40.64)	1.900" (48.26)	2.400" (60.96)	2.900" (73.66)	3.100" (78.74)

### Part numbers

No. of contacts 6, 10, 14, 16, 20, 26, 34, 40, 50, 60, 64		□□ = Number of Circuits		
<b>Sockets</b>				
Termination Methods	Plating Thickness	Without Strain Relief		Strain Relief Bracket
		Without Center Polarization	With Center Polarization	
Insulation displacement connection	30μ" Au Plating or Gold Flash over Palladium Nickel	050-0 □□ - 435	050-0 □□ - 435A	050-000-0 □□ Must Order Separate
	15μ" Au Plating or Gold Flash over Palladium Nickel	050-0 □□ - 455	050-0 □□ - 455A	



## Series 050 Headers

10 to 64 contact headers compatible with:

**DIN 41651,  
MIL-C-83503**

RoHS  
Compliant

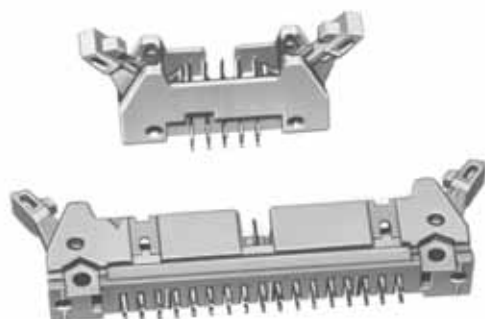

### Wave Solder

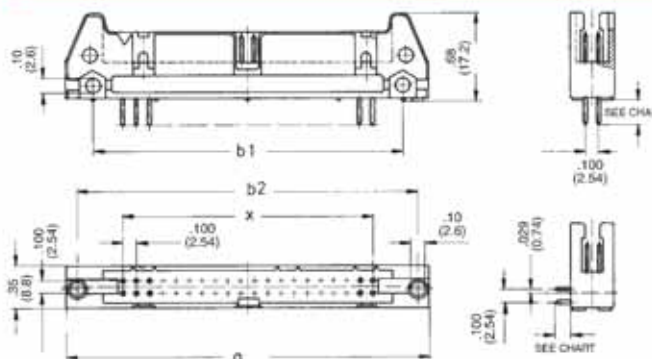

Short locking latches for LAT-CON™ sockets with and without strain relief.



Long locking latches for LAT-CON™ sockets with strain relief.

### Dimensions

	10	14	16	20	26	34	40	50	60	64
<b>a</b>	1.27" (32.3)	1.47" (37.3)	1.57" (39.9)	1.76" (44.7)	2.06" (52.3)	2.46" (62.5)	2.76" (70.1)	3.26" (82.8)	3.76" (95.5)	3.96" (100.6)
<b>b1</b>	.86" (21.8)	1.06" (26.9)	1.16" (29.5)	1.36" (34.5)	1.66" (42.2)	2.06" (52.3)	2.36" (59.9)	2.86" (72.6)	3.36" (85.3)	3.46" (90.4)
<b>b2</b>	1.10" (27.9)	1.30" (33.0)	1.40" (35.5)	1.60" (40.6)	1.90" (48.3)	2.30" (58.4)	2.60" (66.0)	3.10" (78.7)	3.60" (91.4)	3.80" (96.5)
<b>x</b>	.400" (10.16)	.600" (15.24)	.700" (17.78)	.900" (22.86)	1.200" (30.48)	1.600" (40.64)	1.900" (48.26)	2.400" (60.96)	2.900" (73.66)	3.100" (78.74)

## Series 050 Headers

RoHS  
Compliant



### Printed Circuit Layout - Straight

Wave Solder

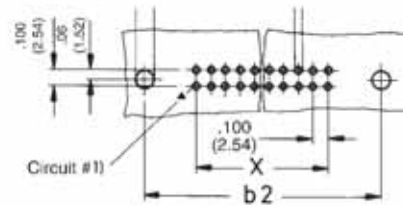

### Printed Circuit Layout - Angled

Wave Solder

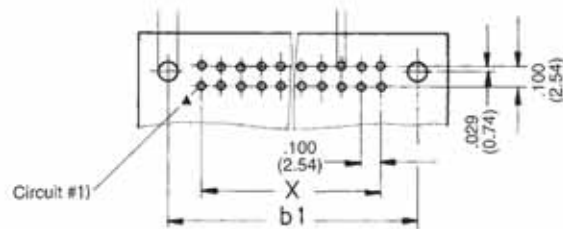

### Part numbers

No. of contacts 10, 14, 16, 20, 26, 34, 40, 50, 60, 64

□□ = Number of Circuits

Style	Termination	Tail Length	Plating Thickness	
			30µ" Au or Gold Flash over Palladium Nickel	15µ" Au or Gold Flash over Palladium Nickel
	Wave solder angled	.177 (4.5 mm)	050-0 □□ - 032	050-0 □□ - 052
		.114 (2.9 mm)	050-0 □□ - 033	050-0 □□ - 053
	Wave solder straight	.177 (4.5 mm)	050-0 □□ - 132	050-0 □□ - 152
		.114 (2.9 mm)	050-0 □□ - 133	050-0 □□ - 153
	Wave solder angled	.177 (4.5 mm)	050-0 □□ - 032A	050-0 □□ - 052A
		.114 (2.9 mm)	050-0 □□ - 033A	050-0 □□ - 053A
	Wave solder straight	.177 (4.5 mm)	050-0 □□ - 132A	050-0 □□ - 152A
		.114 (2.9 mm)	050-0 □□ - 133A	050-0 □□ - 153A
	Wave solder angled	.177 (4.5 mm)	050-0 □□ - 032B	050-0 □□ - 052B
		.114 (2.9 mm)	050-0 □□ - 033B	050-0 □□ - 053B
	Wave solder straight	.177 (4.5 mm)	050-0 □□ - 132B	050-0 □□ - 152B
		.114 (2.9 mm)	050-0 □□ - 133B	050-0 □□ - 153B

\*Contact Factory For Press-Fit/Compliant Pin Options & Tooling

## Series 057 Low Profile Headers

6 to 64 contact

RoHS  
Compliant

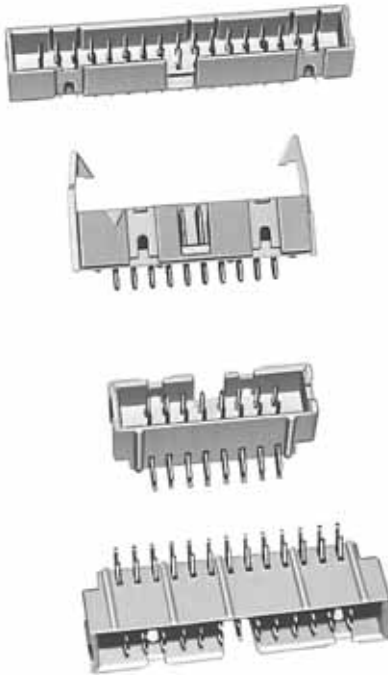

### Straight

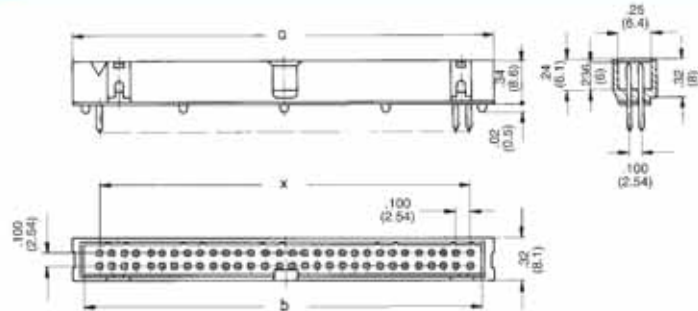

### Angled

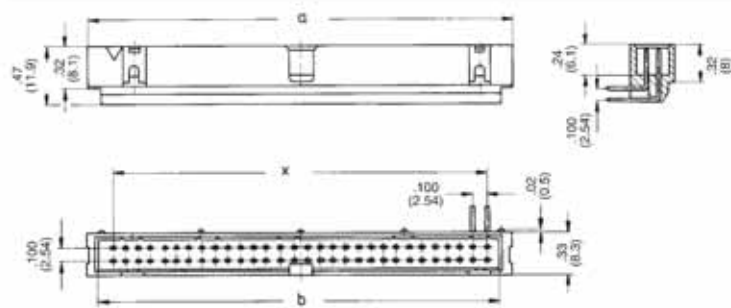

### Printed Circuit Layout

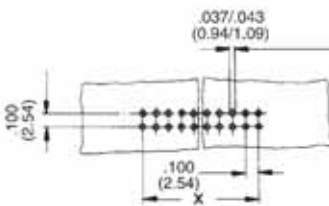

### No. of contacts - Dimensions

	6	10	14	16	20	26	34	40	50	60	64
a	.61" (15.4)	.81" (20.6)	1.01" (25.7)	1.11" (28.2)	1.31" (33.3)	1.61" (40.9)	2.01" (51.1)	2.31" (58.7)	2.81" (71.4)	3.31" (84.1)	3.51" (89.2)
b	.51" (12.9)	.71" (18.0)	.91" (23.1)	1.01" (25.7)	1.21" (30.7)	1.51" (38.3)	1.91" (48.5)	2.21" (56.1)	2.71" (68.8)	3.21" (81.5)	3.41" (86.6)
x(c)	.200" (5.08)	.400" (10.16)	.600" (15.24)	.700" (17.78)	.900" (22.86)	1.200" (30.48)	1.600" (40.64)	1.900" (48.26)	2.400" (60.96)	2.900" (73.66)	3.100" (78.74)

### Part numbers

No. of contacts 6, 10, 14, 16, 20, 26, 34, 40, 50, 60, 64

□□ = Number of Circuits

Termination Methods	Tail Length	Plating Options	Style	
			Straight	Angled
Wave Solder	.177" (4.5mm)	30μ" Au/Ni or gold flash over palladium nickel	057-0 □□ - 132	057-0 □□ - 032
		15μ" Au/Ni or gold flash over palladium nickel	057-0 □□ - 152	057-0 □□ - 052
	.114" (2.9mm)	30μ" Au/Ni or gold flash over palladium nickel	057-0 □□ - 133	057-0 □□ - 033
		15μ" Au/Ni or gold flash over palladium nickel	057-0 □□ - 153	057-0 □□ - 053

Contact factory for press-fit availability



## Series 057 Low Profile IDC Headers

### 10 to 64 Contact

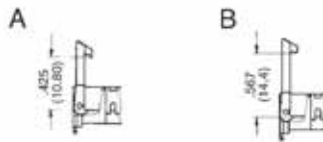

Short locking latch (A) for **LAT-CON**™ sockets with and without strain relief.

Long locking latch (B) for **LAT-CON**™ socket with strain relief.

Note: The 057 series IDC Headers are not RoHS Compliant. The contacts are plated with Tin/Lead over Nickel.

#### No Flange

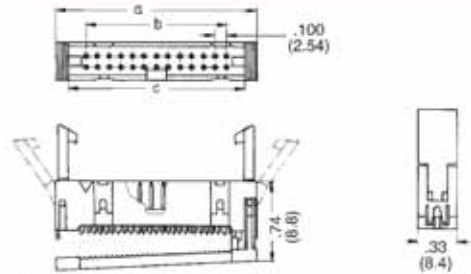

#### Slotted Flange

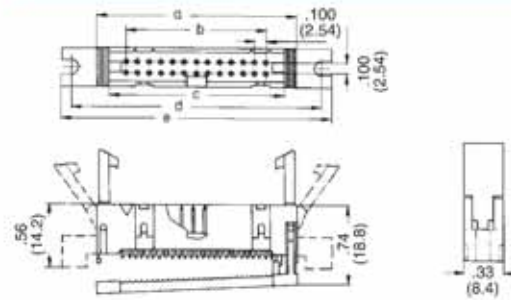

#### No. of contacts - Dimensions

	10	14	16	20	26	34	40	50	60	64
a	.91" (23.1)	1.11" (28.2)	1.21" (30.7)	1.41" (35.8)	1.71" (43.4)	2.11" (53.6)	2.41" (61.2)	2.91" (73.9)	3.41" (86.6)	3.61" (91.7)
b	.400" (10.16)	.600" (15.24)	.700" (17.78)	.900" (22.86)	1.200" (30.48)	1.600" (40.64)	1.900" (48.26)	2.400" (60.96)	2.900" (73.66)	3.100" (78.74)
c	.71" (18.0)	.91" (23.1)	1.01" (25.6)	1.21" (30.7)	1.51" (38.3)	1.91" (48.3)	2.21" (56.1)	2.71" (68.8)	3.21" (81.5)	3.41" (86.6)
d	1.20" (30.5)	1.40" (35.6)	1.50" (38.1)	1.70" (43.2)	2.00" (50.8)	2.40" (61.0)	2.70" (68.6)	3.20" (81.3)	3.70" (94.0)	3.90" (99.1)
e	1.50" (38.1)	1.70" (43.2)	1.80" (45.7)	2.00" (50.8)	2.30" (58.3)	2.70" (68.6)	3.00" (76.2)	3.50" (88.9)	4.00" (101.6)	4.20" (106.7)

#### Part numbers

No. of contacts 10, 14, 16, 20, 26, 34, 40, 50, 60, 64

□□ = Number of Circuits

Termination Methods	Plating Options	Style						Strain Relief Bracket
Insulation Displacement Connection	30µ" Au/Ni or Gold Flash over Palladium Nickel	057-0 □□ - 135PB	057-0 □□ - 135APB	057-0 □□ - 135BPB	057-0 □□ - 135SPB	057-0 □□ - 135SAPB	057-0 □□ - 135SBPB	057-000-0□□
	15µ" Au/Ni or Gold Flash over Palladium Nickel	057-0 □□ - 155PB	057-0 □□ - 155APB	057-0 □□ - 155BPB	057-0 □□ - 155SPB	057-0 □□ - 155SAPB	057-0 □□ - 155SBPB	

\*Contact Factory For Circuit Size and Availability

All products packaged 25 pieces per package

## Series 056 Transition Connectors

### 6 to 64 contact PCB Mount

RoHS  
Compliant

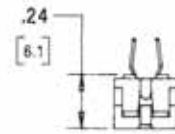
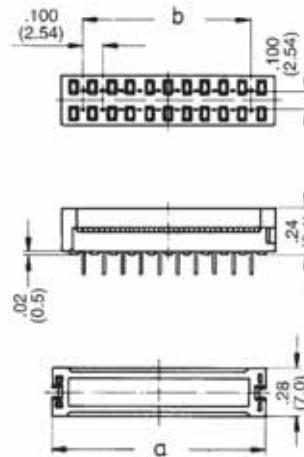

TERMINATED HEIGHT

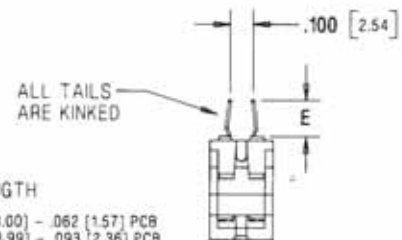

### Printed Circuit Layout

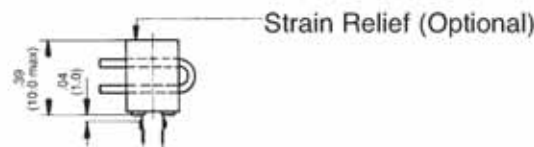
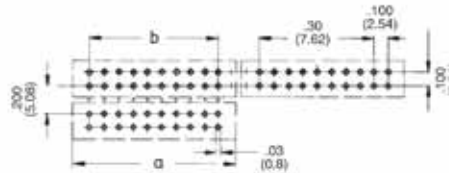

Strain Relief (Optional)

**LAT-CON™** Series 056 – PC-board connectors in IDC-technique, one side open for lateral flat cable insertion, two rows, grid .100" (2,54 mm). Contact plating Sn/Ni.

### No. of contacts / Dimensions

	6	10	14	16	20	26	34	40	50	60	64
a	.48" (12.2)	.68" (17.3)	.88" (22.4)	.98" (24.9)	1.18" (30.0)	1.48" (37.6)	1.88" (47.8)	2.18" (55.4)	2.68" (68.1)	3.18" (80.8)	3.38" (85.9)
b	.200" (5.08)	.400" (10.16)	.600" (15.24)	.700" (17.78)	.900" (22.86)	1.200" (30.48)	1.600" (40.64)	1.900" (48.26)	2.400" (60.96)	2.900" (73.66)	3.100" (78.74)

### Part numbers

No. of contacts 6, 10, 14, 16, 20, 26, 34, 40, 50, 60, 64

□□ = Number of Circuits

Termination Methods		Contact Plating	Style/Kinked Tail	
Wave Solder	Insulation Displacement Connection	Sn/Ni		
			056-0 □□ - 393/K	056-0 □□ - 392/K

## Series 050 Accessories

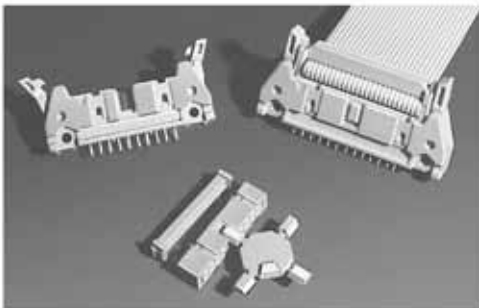

### Series 050 Coding Wedge

Part Number	<b>100-000-043</b>
Packaging Unit	100 Wedges
No. of Contacts	No. of Coding Slots
6, 10, 14, 16,	1
20, 26	2
34, 40	3
50	4
60, 64	5

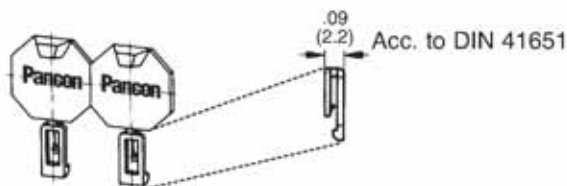

### Military Polarizing Key

Part Number	<b>050-000-077</b>
Packaging Unit	100 Pcs.

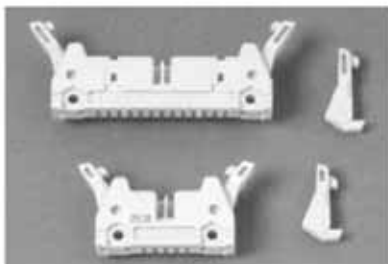

### Locking Latches

Style	Part Numbers
For sockets with or without strain relief	<b>050-000-062</b>
For sockets with strain relief	<b>050-000-063</b>
Packaging Unit	25 Pairs

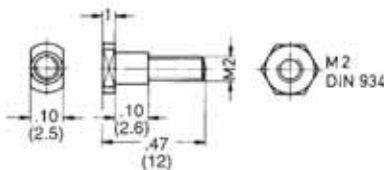

### Mounting Accessories — Screw

Part Number	<b>050-000-022</b>
Packaging Unit	100 Pcs.

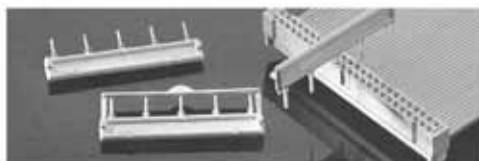

### Polarizing Plug

Part Number	<b>050-000-044</b>
Packaging Unit	100 Pcs.



**Series 057  
Accessories****Series 057/Locking Latches**

Short	057-000-065
Long	057-000-075
Packaging Unit	25 Pairs

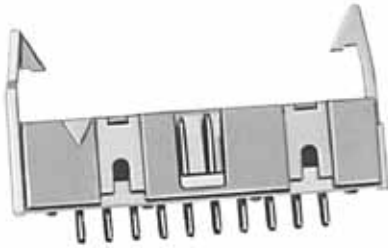
**Series 057 Locking Latches**

Part Number	057-000-100
Packaging Unit	100 Pairs

## Series 051 Dual Row Unshrouded Headers

6 to 80 contact

RoHS  
Compliant

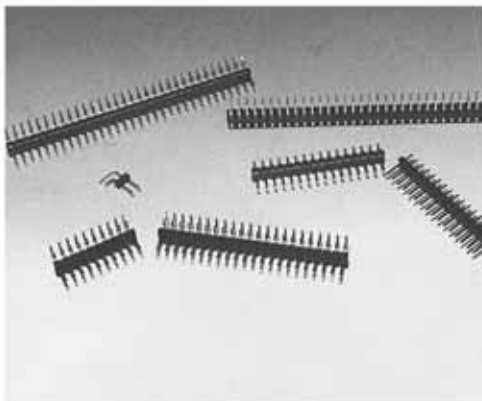

The series 051 headers are available in 6 to 80 circuit sizes. They can be cut down to any required circuit size.

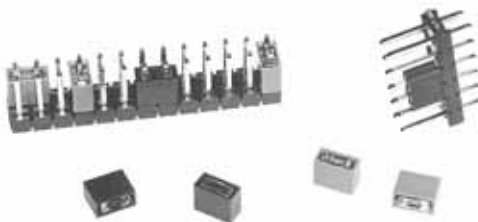

### Straight Pins

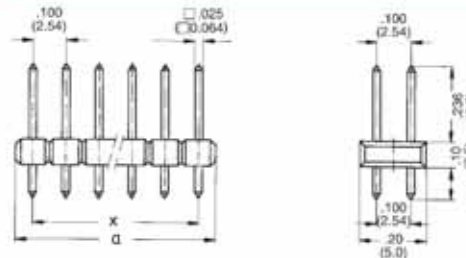

### Angled Pins

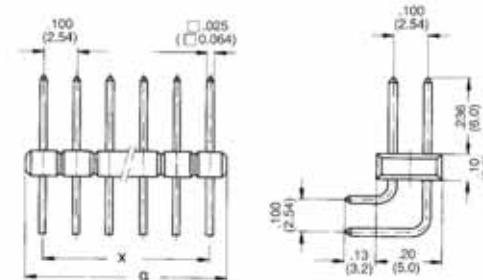

### Printed Circuit Layout

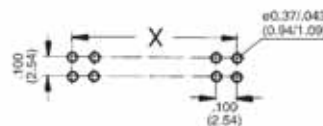

### Shunts

Part number	Contact Plating	Color
051-000-451	15 $\mu$ " Sn/Ni	Green
051-000-411	200 $\mu$ " Sn/Ni	Black

### No. of contacts - Dimensions

	6	10	14	16	20	26	34	40	50	60	64
a	.30" (7.6)	.50" (12.7)	.70" (17.8)	.80" (20.3)	1.00" (25.4)	1.30" (33.0)	1.70" (43.2)	2.00" (50.8)	2.50" (63.5)	3.00" (76.2)	3.20" (81.3)
b	200" (5.08)	400" (10.16)	600" (15.24)	700" (17.78)	900" (22.86)	1.200" (30.48)	1.600" (40.64)	1.900" (48.26)	2.400" (60.96)	2.900" (73.66)	3.100" (78.74)

### Part numbers

No. of contacts 6, 8, 10, 14, 16, 20, 26, 34, 40, 50, 60, 64, 80

□□ = Number of Circuits

Termination Methods	Plating Options	Style	
		Straight	Angled
Wave Solder	200 $\mu$ " - (Sn/Ni)	051-0 □□ - 113	051-0 □□ - 013
	30 $\mu$ " - (Au/Ni)	051-0 □□ - 133	051-0 □□ - 033
	15 $\mu$ " - (Au/Ni)	051-0 □□ - 153	051-0 □□ - 053
	Gold Flash/Ni	051-0 □□ - 183	051-0 □□ - 083

**PAN-FLEX™**  
**.050" Flat Cable**

**RoHS**  
**Compliant**

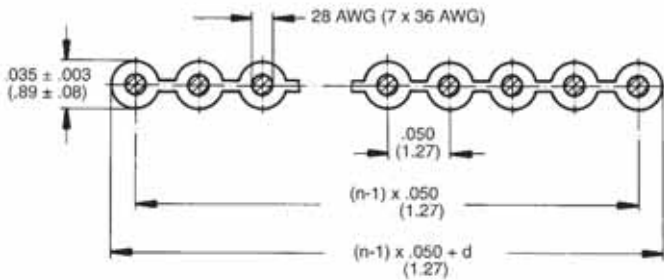

Conductors	Part Numbers	Per Reel
	Only 1st Conductor is Color-marked	
6	<b>050F28V6 CR*</b>	(100 FT)
10	<b>050F28V10 CR*</b>	
14	<b>050F28V14 CR*</b>	
16	<b>050F28V16 CR*</b>	
20	<b>050F28V20 CR*</b>	
26	<b>050F28V26 CR*</b>	
32	<b>050F28V32 CR*</b>	
34	<b>050F28V34 CR*</b>	
40	<b>050F28V40 CR*</b>	
50	<b>050F28V50 CR*</b>	
60	<b>050F28V60 CR*</b>	
64	<b>050F28V64 CR*</b>	

**\*CR = 100ft Rolls**  
**THR = 300ft Rolls**  
(Available on 10, 14, 20, 26, 34 and 50 circuit sizes)

Conductor	CU Tinned
Insulation	PVC Gray
Conductor Resistance	≤ 230 Ω/km
Insulation Resistance	≥ 90 x 10 <sup>9</sup> Ω/km
Capacitance	56 pF/m
Voltage Rating	300 V <sup>eff</sup>
Temperature Rating	-20 °C/ + 105 °C



## Tools



The manual press MCP5 in combination with the corresponding die set provides maximum termination reliability and a significant reduction in flat cable assembling time.

### Manual Termination Press and Die Set

Description	Series	Part Number
Manual Press	All	<b>MCP5</b>
Die Set Including Termination	050	<b>CPD64F50FM</b>
	056	<b>CPD64F52PM</b>
	057	<b>CPD64F50HM</b>



Compact air operated bench press. Operator manually leads sockets and inserts flat cable laterally into socket and actuates the press with a foot switch. Operates on 85-95 psi non-lubricated air.

### Manually-Fed Pneumatic Termination Press

Part Number	
Series 050	<b>CTM64F50FM</b>



Preassembled sockets on tape are automatically fed into the press and into termination position. Operator manually installs cable laterally into socket and actuates the press with a foot switch. Terminated socket is automatically ejected. Operates on 85-95 psi non-lubricated air. 110 VAC – 220 V transformer is supplied with the tool.

### High Volume Reel-Feed Pneumatic Termination Press

Part Number	
Series	<b>CTM64F50FRI</b>

**Tools**

**Manual Tool**



**LCTM**

Automatic test and termination of Series 050 female connectors • Modular system – can easily be switched from manual termination to reel-fed termination • each termination is automatically tested; possible sources for misterminations are automatically identified and indicated on an LCD-display • precise alignment of the flat cable by a newly designed positioner • termination process can only be released when cable and connector are properly positioned.

**Pneumatic Bench Press For Manual and Reel -Fed Termination with Integrated Connection Tester**

Part Number		
Pneumatic Bench Press	For Reel-Fed Termination	For Manual Termination
Series 050	LCTM64F50FRT	LCTM64F50FT

**Series 050 + 057/Press Fit Insertion Die**

Part Number	050/057-0□□-3XX
Termination Methods	Straight Tail Press-Fit
Series 050 + 057	200-022-1 □□



□□ = Number of circuits

## D-Subminiature IDC Metal Shell

### Socket

### Plug

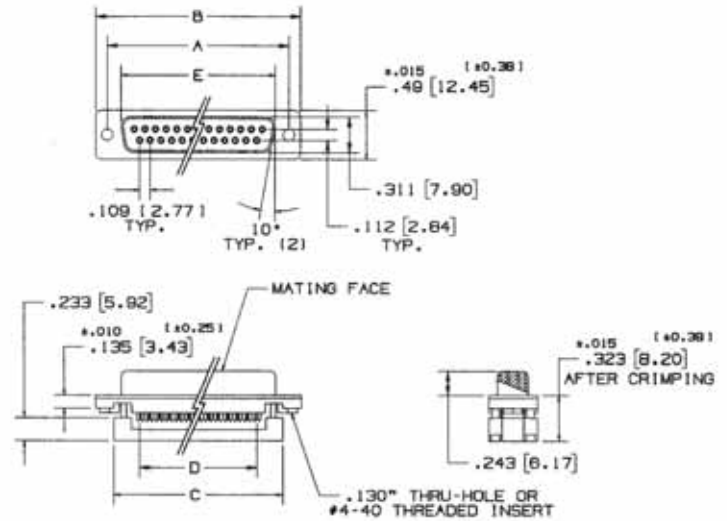
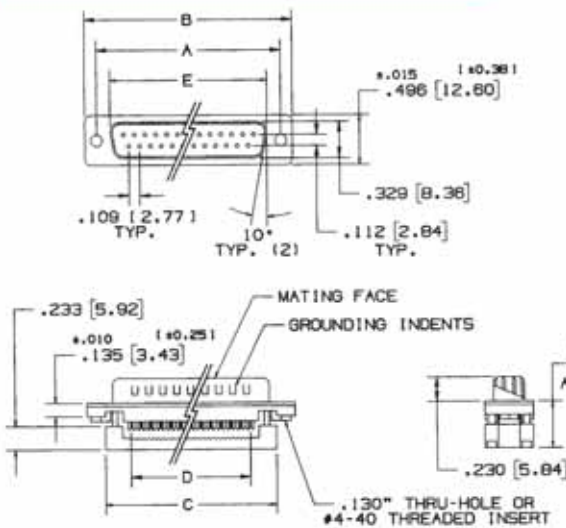

### Strain Relief

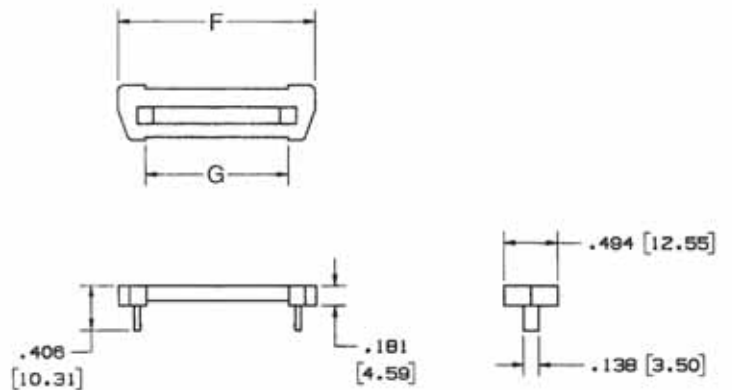

### Dimensions

Number of Ckts.	A ±015 (.13)	B ±015 (.30)	C	D	E Socket	E Plug	F	G
9	0.984 (24.99)	1.216 (30.8)	.885 (22.5)	.400 (10.16)	.643 (16.33)	.666 (16.9)	.888 (22.6)	.48 (12.2)
15	1.312 (33.32)	1.54 (39.1)	1.215 (30.9)	.700 (17.78)	.971 (24.66)	.994 (25.3)	1.215 (30.9)	.78 (19.8)
25	1.852 (47.04)	2.090 (53.09)	1.750 (44.4)	1.200 (30.48)	1.511 (38.38)	1.534 (39.0)	1.754 (44.5)	1.28 (32.6)
37	2.500 (63.50)	2.732 (69.4)	2.415 (61.3)	1.800 (45.72)	2.159 (54.84)	2.138 (55.4)	2.143 (61.3)	1.89 (47.9)

### Ordering Information

No. of Ckts.	Socket		Plug		Strain* Relief	Jack* Screws (1 ea)
	Thru-Hole	4-40 Threaded	Thru-Hole	4-40 Threaded		
	15µ" (.38µm) Gold Plating					
9	IDM9SH5	IDM9ST5	IDM9PH5	IDM9PT5	DA009	—
15	IDM15SH5	IDM15ST5	IDM15PH5	IDM15PT5	DA015	DA001A
25	IDM25SH5	IDM25ST5	IDM25PH5	IDM25PT5	DA025	—
37	IDM37SH5	IDM37ST5	IDM37PH5	IDM37PT5	DA037	—

\*Optional, order separately



**IDC Ribbon**

**Plug**

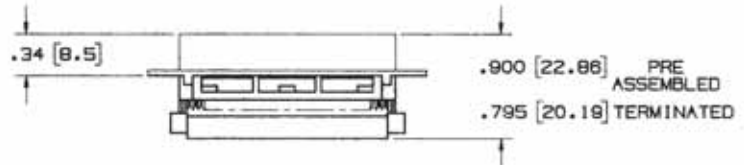
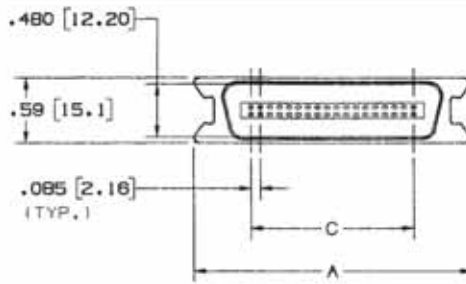

**Socket**

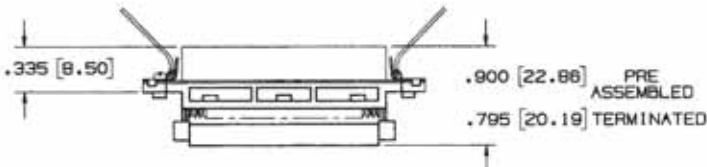
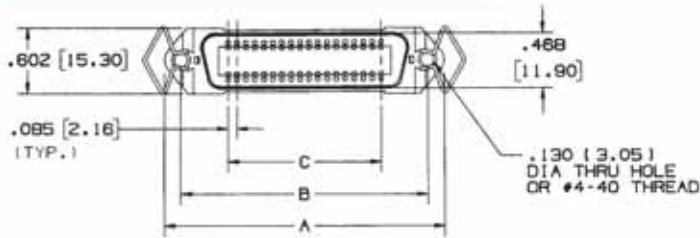

**Strain Relief**

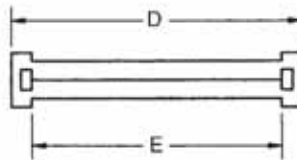

**RoHS**  
Compliant



**Dimensions**

Number of Ckts.	A Socket	A Plug	B	C	D	E
36	2.685 (68.2)	2.425 (61.6)	2.352 (59.74)	1.446 (36.72)	2.115 (53.7)	1.81 (46.0)
50	3.280 (83.3)	3.020 (76.7)	2.947 (74.85)	2.041 (51.84)	2.710 (68.8)	2.41 (61.1)

**Ordering Information**

No. of Ckts.	Socket		Plug	Strain* Relief
	Bail Latch/ 4-40 THD.	Bail Latch/ Thru-Hole	Bail Latch Opening	
	15µ" (.38µm) Gold Plating			
36	—	IRM36SK5	IRM36PL5	RA036
50	IRM50SG5	IRM50SK5	IRM50PL5	RA050

\*Optional, order separately

## D- Subminiature PCB Right Angle

RoHS Compliant **CAUS**

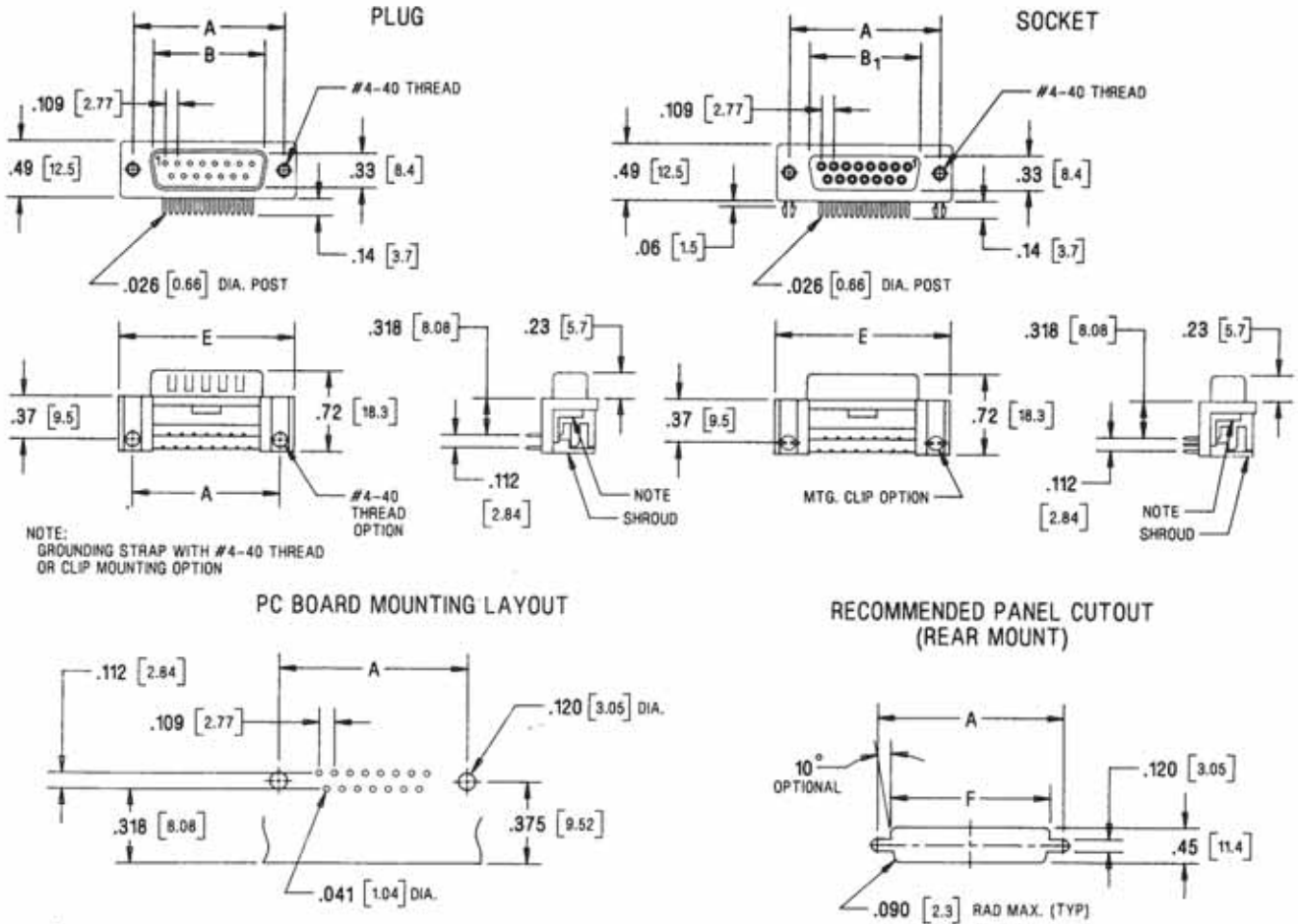

### Dimensions

Number of Ckts.	A ±0.005 (0.13)	B (Plug)	B (Socket)	E ±0.015 (0.38)	F
9	0.984 (24.99)	0.666 (16.92)	0.643 (16.33)	1.216 (30.89)	0.807 (20.50)
15	1.312 (33.32)	0.994 (25.25)	0.971 (24.66)	1.539 (39.10)	1.134 (28.80)
25	1.852 (47.04)	1.534 (38.96)	1.511 (38.38)	2.090 (53.09)	1.673 (42.50)
37	2.500 (63.50)	2.182 (55.42)	2.159 (54.04)	2.732 (69.40)	2.327 (59.10)

### Ordering Information

No. of Ckts.	Socket		Plug	Jack Screws* (1ea)
	4-40 THD/ 4-40 THD	4-40 THD/ MTG Clip	4-40 THD/ MTG Clip	
	15µ" (.38µm) Gold Plating			
9	RDM9SA5	RDM9SB5	RDM9PB5	DA001A
15	RDM15SA5	—	RDM15PB5	
25	RDM25SA5	RDM25SB5	RDM25PB5	
37	RDM37SA5	RDM37SB5	—	

\*Optional, order separately

## I.O. Connectors Right Angle PCB Ribbon

RoHS  
Compliant

CRUS

### SOCKET

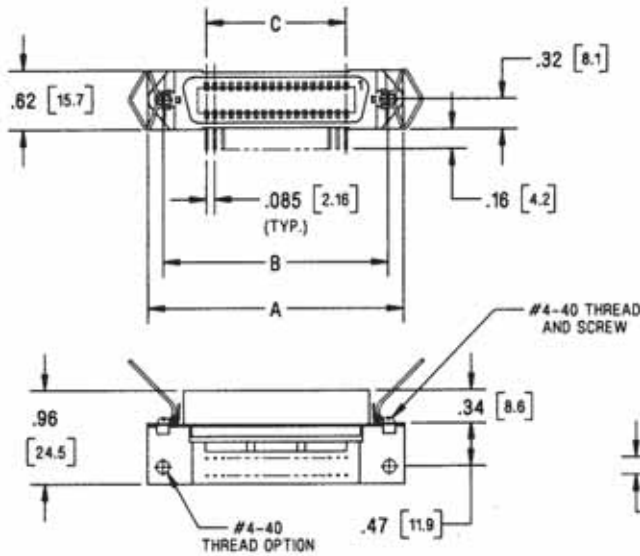

### MOUNTING CLIP OPTION

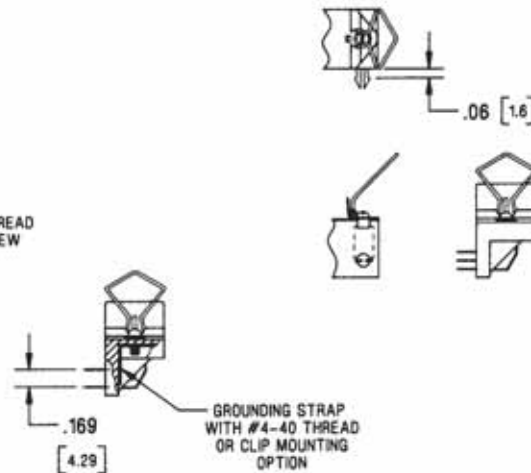

### PC BOARD MOUNTING LAYOUT

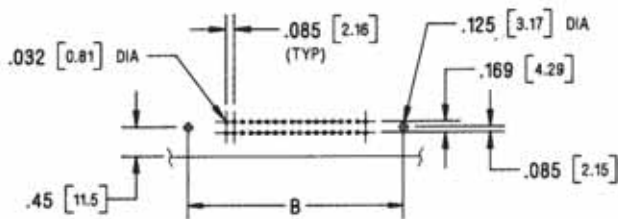

### RECOMMENDED REAR PANEL CUTOUT

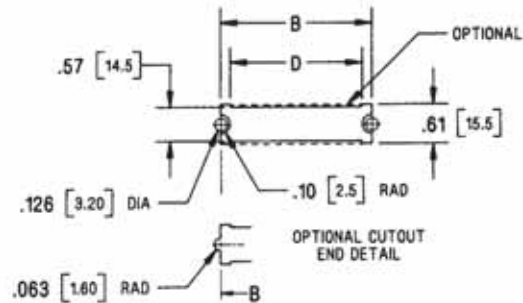

## Dimensions

Number of Ckts.	A	B	C	D
36	2.685 (68.20)	2.352 (59.74)	1.446 (36.72)	2.047 (52.00)
50	3.280 (83.30)	2.947 (74.85)	2.041 (51.84)	2.602 (66.10)

## Ordering Information

No. of Ckts.	Socket	
	Bail Latch* 4-40 THD	Bail Latch* MTG. Clip
	15µ" (.38µm) Gold Plating	
36	RRM36SF5	RRM36SE5
50	—	RRM50SE5

\*Connectors and bail latch are packaged separately



## Part Number System

# FLAT CABLE CONNECTORS® (IDC)

Part number system:

**050 - 010 - 4 3 5 A**

Type		
Fully shrouded headers	050	
IDC sockets	050	
Unshrouded headers, dual row	051	
IDC-transition connector	056	
Low profile header	057	
Low profile IDC header	057	

N° of circuits		
Fully shrouded headers	10, 14, 16, 20, 26, 34, 40, 50, 60, 64	
IDC sockets	6, 10, 14, 16, 20, 26, 34, 40, 50, 60, 64	
Unshrouded headers, dual row	6, 8, 10, 14, 16, 20, 26, 34, 40, 50, 60, 64, 80	
IDC transition connector	6, 10, 14, 16, 20, 26, 34, 40, 50, 60, 64	
Low profile header	6, 10, 14, 16, 20, 26, 34, 40, 50, 60, 64	
Low profile IDC header	6, 10, 14, 16, 20, 26, 34, 40, 50, 60, 64	

Variations		
Center polarization, sockets	A	
Short ejector latches, headers	A	
Long ejector latches, headers	B	
on reels, sockets	R	

Pin length headers		
3,6 / 4 / 4,5 / 5 mm	2	
2,9 / 3,0 / 3,2 mm	3	
socket	5	

Plating		
Sn/Ni	1	
Au, 30µ"	3	
Au, 15µ"	5	
056 PCB-transition connector tin plated	9	

Style		
header, angled pins	0	
header, straight pins	1	
header, press fit pins	3	
socket	4	

**Notes**

## ***Electronic Connectors***

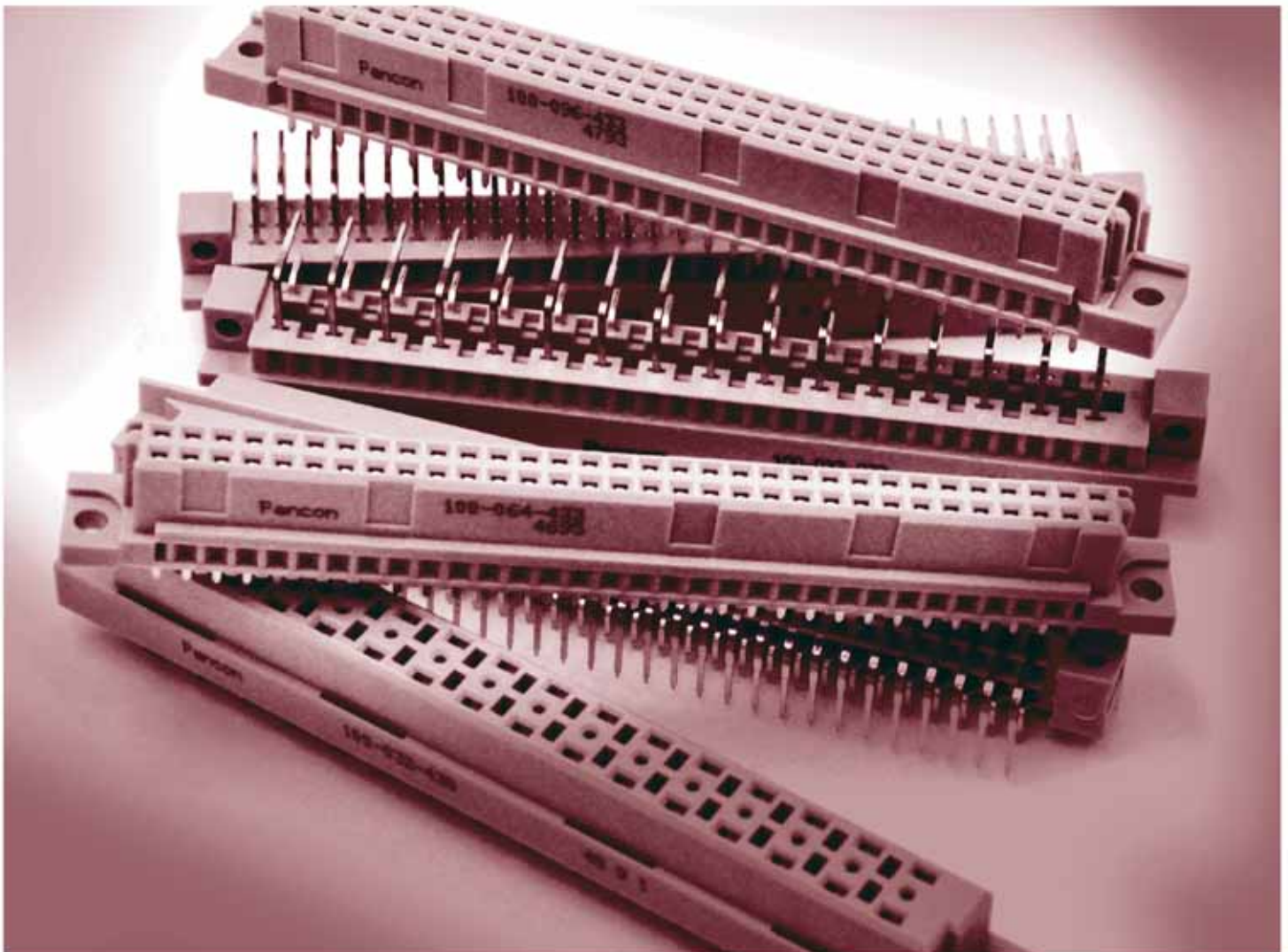

**HI-CON™**

**Printed Circuit Connectors**

*Two Piece Printed Circuit Connectors.  
Dimensions According to DIN 41612*



## Index

Series	Type	Male connectors								Female connectors							
		Number of contacts															
		16	20	30	32	48	64	96	128	16	20	30	32	48	64	96	128
Technical Data																	
Mating conditions – acc. to DIN 41612 part 1																	
Spacing between rows according to DIN 416129																	
100	½B				•					•			•				
	½C			•								•					
	½C				•	•							•	•			
	B				•		•						•		•		
	C				•		•	•					•		•	•	
Printed circuit layout for female connectors with angled pins Type half B, half C, B and C																	
100	D				•								•				
	E					•								•			
101	F					•								•			
106	C + 1								•								•
130	Q						•								•		
	½R					•							•	•			
	R						•	•							•	•	
Cable housing for type C, D, F, R																	
Accessories and Tools																	
Interface system for front and back panel applications																	
Flat cable connector system – dimensions according to DIN 41 612 – DIN 41 61269 – 76																	
120	B						•								•		
	½C				•								•				
	C						•	•							•	•	
Accessories and Tools																	
Part Number System																	

See page 99 for part number system

## Index

Page	Performance Level		Termination Methods				
	2	3	Solder Contact	Wrap Contact	Solder Eyelet	Compliant Pin	IDC-Technique
54, 55							
56							
56							
57, 58	•	•	•	•			
59, 60	•	•	•				
61, 62	•	•	•	•			
63, 64	•	•	•	•			
65-67	•	•	•	•	•	•	
68							
69, 70	•	•	•				
71, 72	•	•	•	•			
73, 74	•	•	•		•		
75, 76	•	•	•				
77, 78	•	•	•	•			
79, 80	•	•	•				
81, 82	•	•	•			•	
84, 87, 88							
84-89							
86, 87	Connector Housing, Guide Frames, Frames for Special Application, Converter Frames, Female Connectors for Interface Connections and Accessories						
90							
93, 94	•		•				•
91, 92	•		•				•
95, 96	•	•	•				•
97							
99							

## Technical Data

Type and Number of Contacts		1/3 C 30	1/2 B 32 1/2 Q 32	1/2 C 48 1/2 R 48
Insertion and Withdrawal Force Nmax		28	30	45
Current Carrying Capacity		See Diagram		
	Contact Chassis	K	0.07 (1.8 mm)	
		L	0.06 (1.6 mm)	
Creepage (K) and Clearance (L) Distance* in (mm)		K	0.05 (1.2 mm)	
	Contact/Contact	L	0.05 (1.2 mm)	
Test VoltageU		1000 V		
Contact Resistance		≤20 mΩ		
Insulation Resistance		10 <sup>12</sup> Ω		
Temperature Range		- 55...+ 125 °C		
Contact Material	Header	CuZn		
	Socket	CuSn		
Housings		PBT GF		
Flammability acc. to UL 94		UL 94V-0		
Comparative Tracking Index acc. to IEC 223 DIN VDE 0303 TI. 1		CTI 150		

\* With Special Contacts

DIN 41612 Part 5 Mating Cycles		
Performance Level	1**	Min. 500 Mating Cycles
Performance level	2	Min. 400 Mating Cycles
Performance Level	3	Min. 50 Mating Cycles

\*\* ON REQUEST



## Technical Data

B 64 Q 64		C 32 R 32	C 64 R 64	C 96	C+1 128	D 32	E 48	F 32	F 48
60		30	60	90	120	40	60	50	75
See Diagram Page _____									
0.07 (1.8 mm)							0.24 (6.0 mm)		
0.06 (1.6 mm)							0.14 (3.5 mm)		
0.05 (1.2 mm)	0.12 (3.0 mm)	0.05 (1.2 mm)				0.12 (3.0 mm)			
0.05 (1.2 mm)	0.12 (3.0 mm)	0.05 (1.2 mm)				0.06 (1.6 mm)			
1000 V	1550 V	1000V				1550 V			
20 mΩ						15mΩ			
10 <sup>12</sup> Ω									
-55...+125°C									
CuZn									
CuSn									
PBT GF							PBT GF		
UL 94V-0									
CTI 150						CTI 175			

Operating current per contact related to ambient temperature:

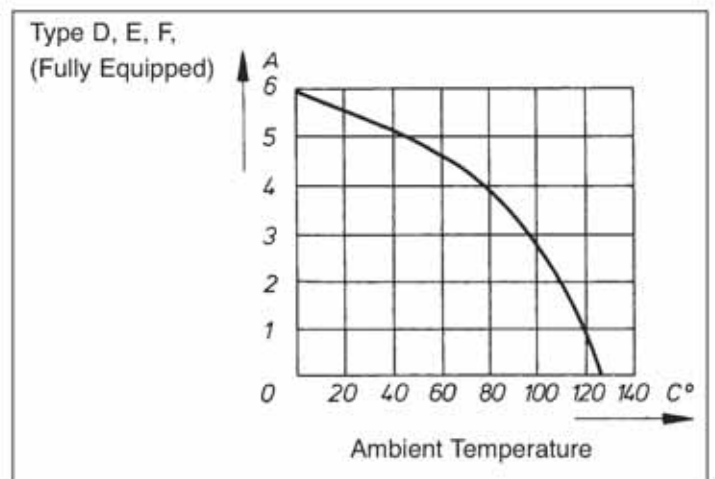
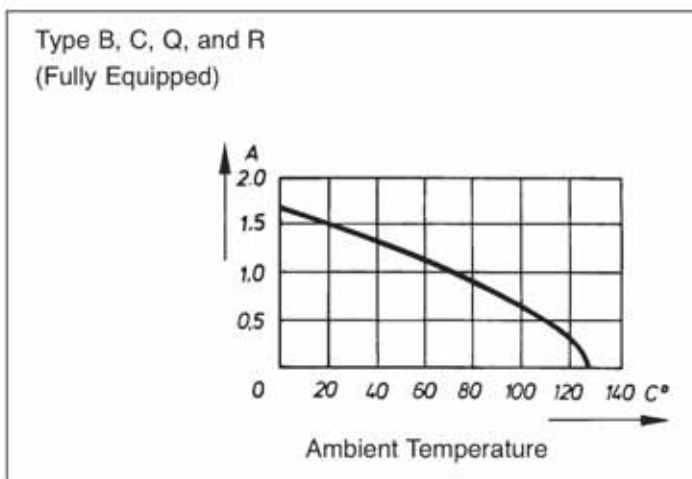

**Technical Data**

**Spacing Between the Rows  
According to DIN 41612 —  
2.54 mm (1/10")**

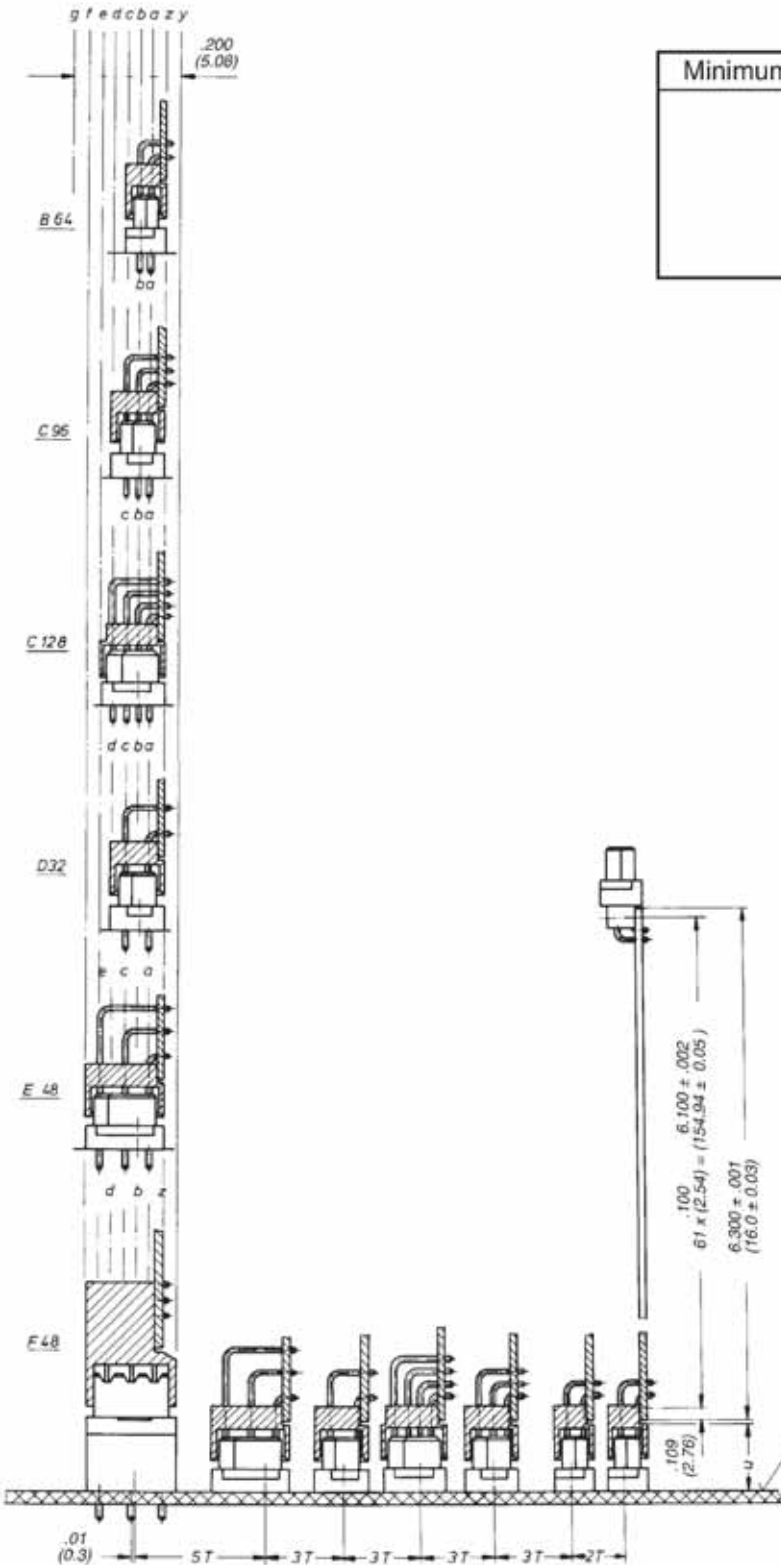

Minimum Distance To Adjoining Female Connector	
Type	B - B = 2 T
	B - C = 3 T
	C - D = 3 T
	D - C + 1 = 3 T
	C + 1 - E = 3 T

Mounting Level

u = 0.49 (12.4) — 0.56 (14.2 mm)

T = .200 (5.08 mm) 2 x .100 (2 x 2.54 mm)

## Type 1/2 B — Series 100

## 32 Contact Male Connectors — Two Row

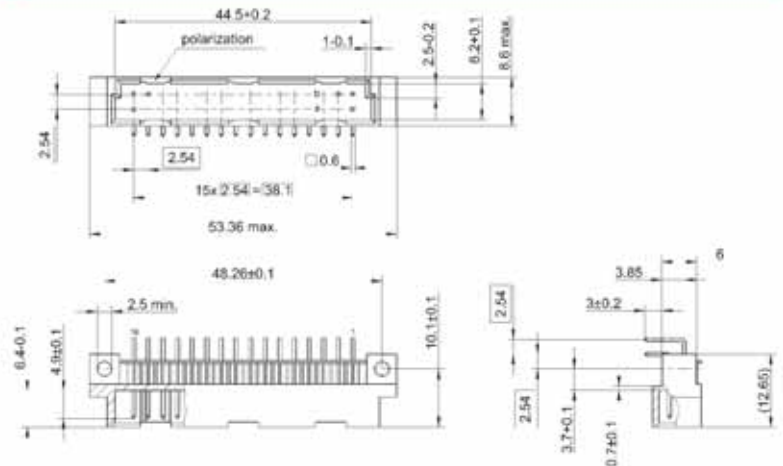

### Printed Circuit Layout

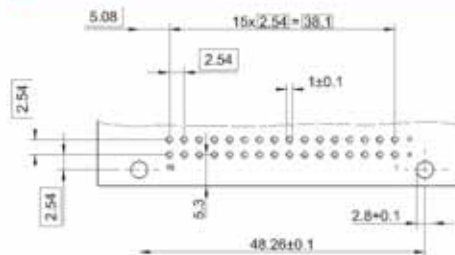

**RoHS  
Compliant**

### Part Numbers

No. of Contacts	Contact Arrangement	Performance Level	Termination Methods	
32	Fully equipped	2	100-632-033	100-632-133
		3	100-632-053	100-632-153



**Type 1/2 B —  
Series 100**

**32 Contact Female  
Connectors — Two Row**

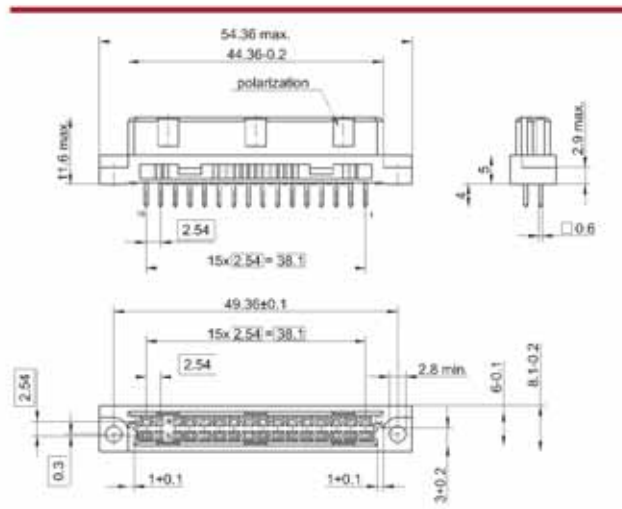



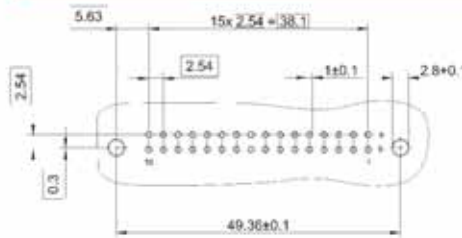

**Printed Circuit Layout - Straight Tail Version**

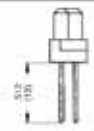

**RoHS  
Compliant**

**Part Numbers**

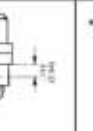
No. of Contacts	Contact Arrangement	Performance Level	Termination Methods				
							
32	Fully Equipped	2	100-632-431	100-632-432	100-632-433	100-632-533	100-632-633*

## Type 1/3 C — Series 100

### 30 Contact Male Connectors — Three Row

**\*Contact Factory for Availability**

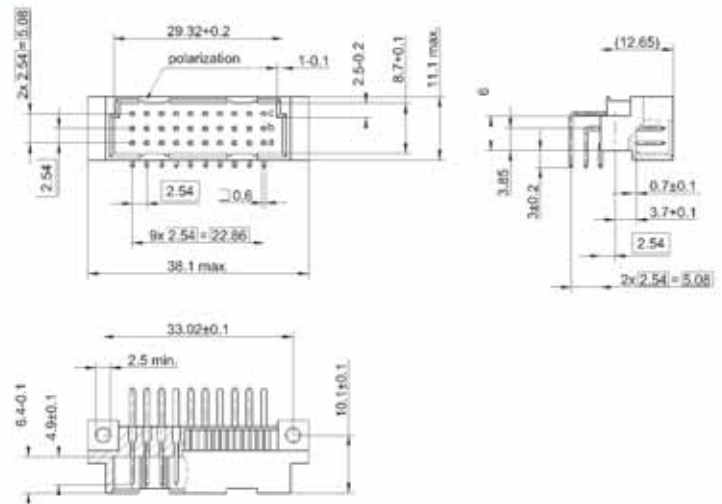

**RoHS  
Compliant**

### Printed Circuit Layout

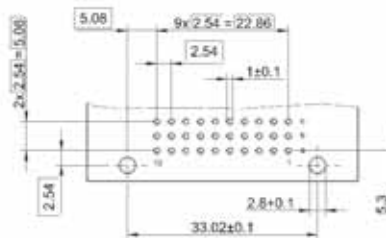

### Part Numbers

No. of Contacts	Contact Arrangement	Performance Level	Termination Methods
30	Fully Equipped	2	100-030-033

**Type 1/3 C —  
Series 100**

**30 Contact Female Connectors  
— Three Row  
\*Contact Factory  
for Availability**

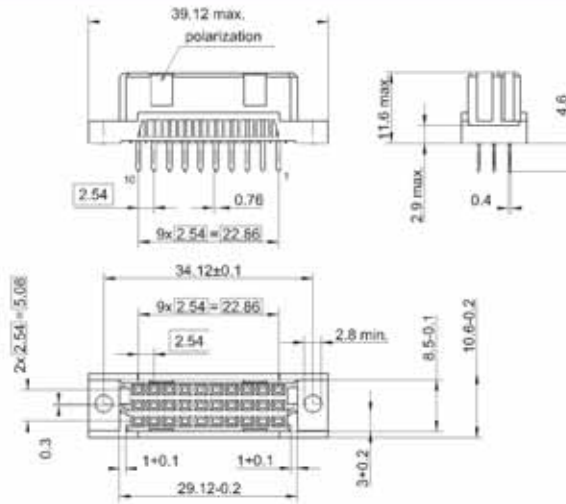

**Printed Circuit Layout**

**RoHS  
Compliant**

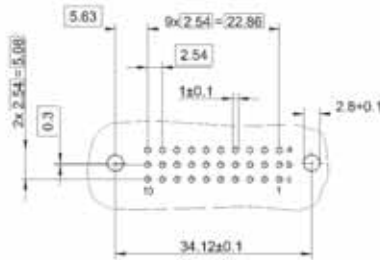

**Part Numbers**

No. of Contacts	Contact Arrangement	Performance Level	Termination Methods
30	Fully Equipped	2	100-030-432



## Type 1/2 C — Series 100

## 32 and 48 Contact Male Connectors — Three Row

**RoHS Compliant**

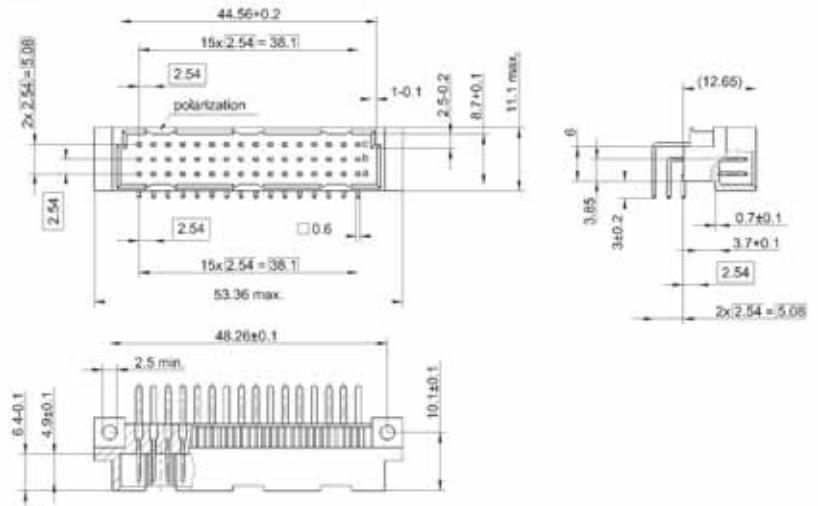

### Printed Circuit Layout

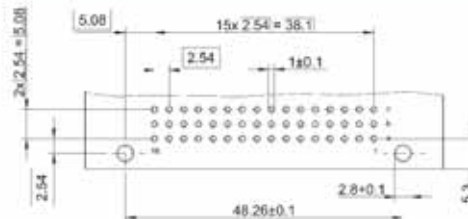

### Part Numbers

No. of Contacts	Contact Arrangement	Performance Level	Termination Methods	
32	Row a + c	2	100-332-033	100-332-133
48	Fully Equipped	2	100-348-033	100-348-133
		3	100-348-053	100-348-153

## Type 1/2 C — Series 100

## 32 and 48 Contact Female Connectors — Three Row

**RoHS Compliant**

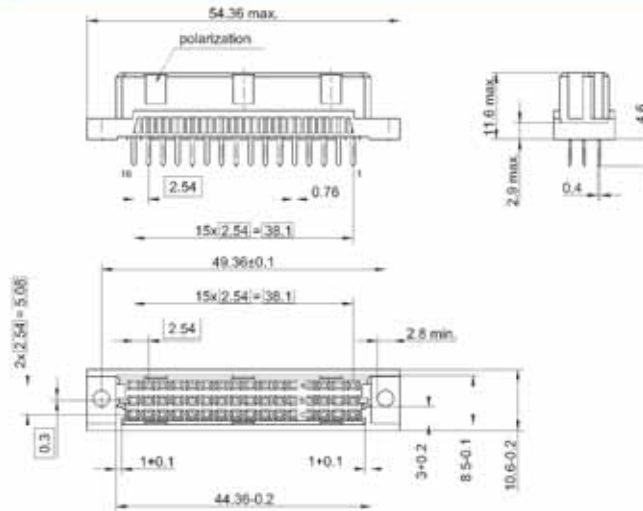

### Printed Circuit Layout - Straight Tail Version

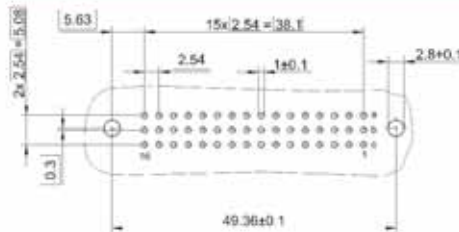

### Part Numbers

No. of Contacts	Contact Arrangement	Performance Level	Termination Methods			
32	Row a + c	2	—	100-332-432	100-332-433	100-332-533
		3	—	100-332-452	—	—
48	Fully Equipped	2	100-348-431	100-348-432	100-348-433	100-348-533
		3	—	100-348-452	—	—

## Type B — Series 100

## 32 and 64 Male Connectors — Two Row

**RoHS  
Compliant**

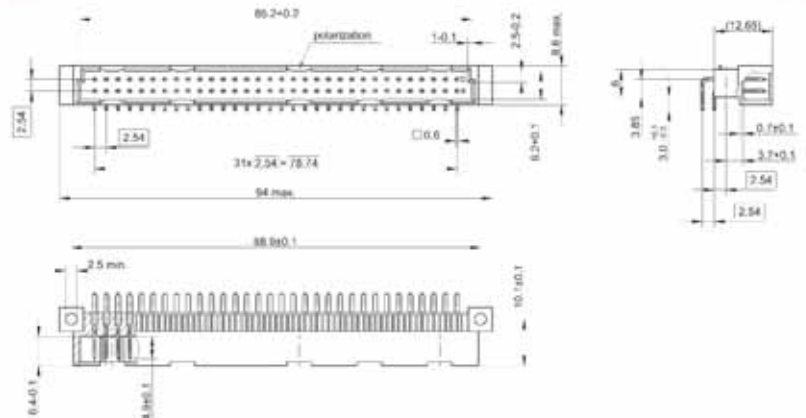

### Printed Circuit Layout



### Part Numbers

No. of Contacts	Contact Arrangement	Performance Level	Termination Methods		
32	Row a + b All Even Numbers	2	100-532-033	—	—
64	Fully Equipped	2	100-064-033	100-064-133	100-064-031
		3	100-064-053	100-064-153	—

## Type B — Series 100

## 32 and 64 Contact Female Connectors — Two Row

RoHS  
Compliant

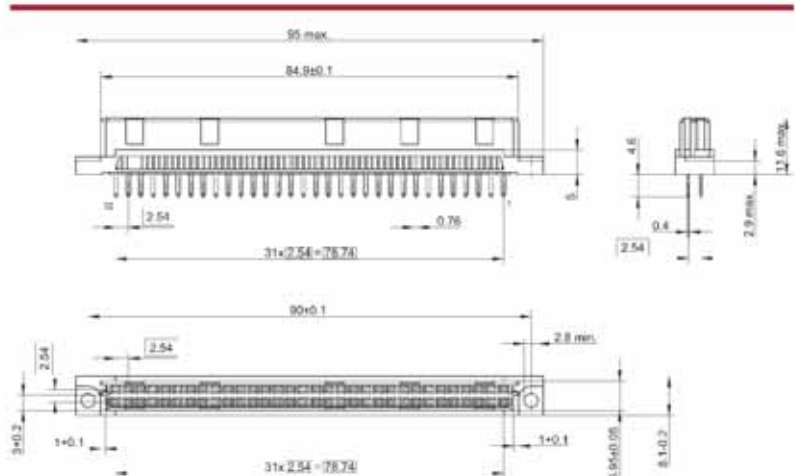

### Printed Circuit Layout - Straight Tail Version

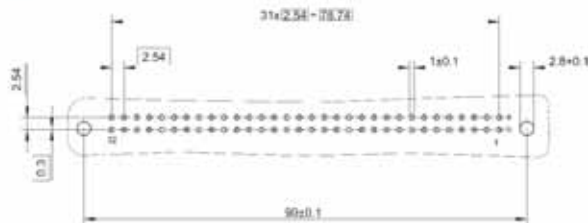

### Part Numbers

No. of Contacts	Contact Arrangement	Performance Level	Termination Methods			
32	Row a + b All Even Numbers	2	—	100-532-432	—	—
64	Fully Equipped	2	100-064-431	100-064-432	100-064-433	100-064-533
		3	—	100-064-452	100-064-453	—

\* Contact Factory For Availability \*\* Printed Circuit Layout On Page 68



## Type C — Series 100

## 32, 64 and 96 Contact Male Connectors — Three Row

RoHS Compliant

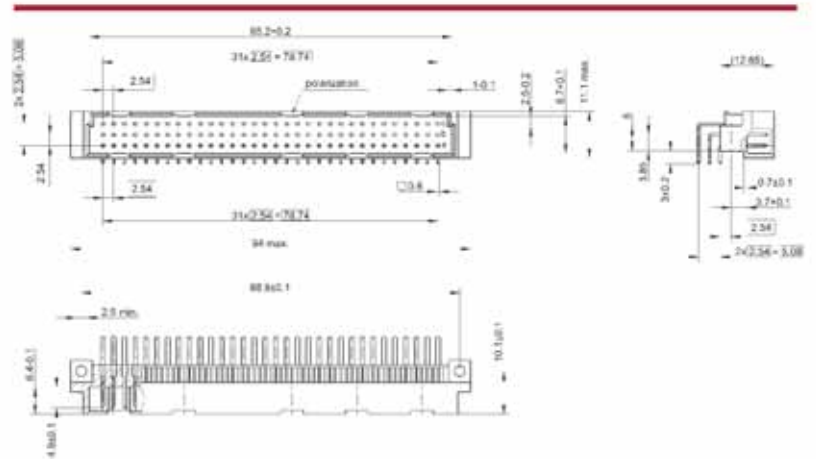

### Printed Circuit Layout

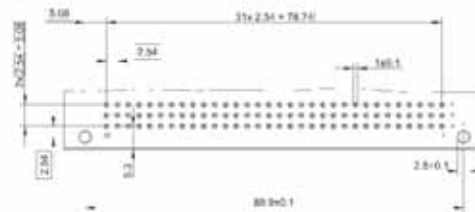

### Part Numbers

No. of Contacts	Contact Arrangement	Performance Level	Termination Methods		
32	Row a + c All Even Numbers	2	100-932-033	100-932-133	—
		3	100-932-053	—	—
64	Row a + c	2	100-964-033	100-964-133	—
		3	100-964-053	—	—
96	Fully Equipped	2	100-096-033	100-096-133	100-096-031
		3	100-096-053	—	—

## Type C — Series 100

## 32, 64 and 96 Contact Female Connectors — Three Row

**RoHS Compliant**

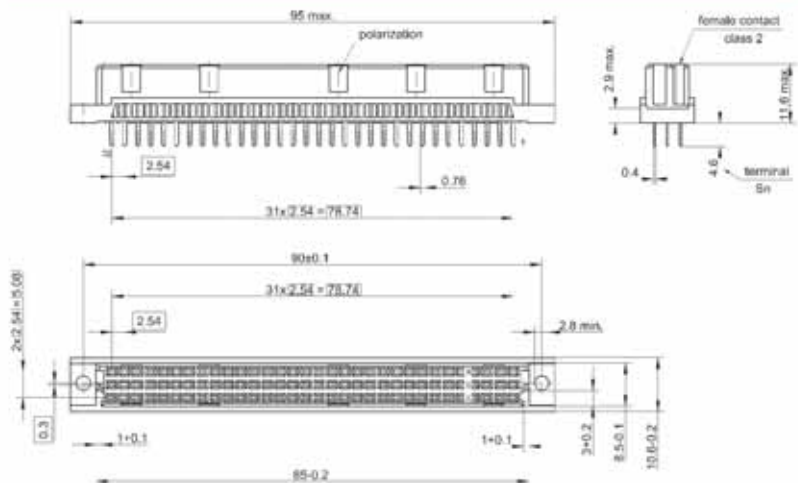

### Printed Circuit Layout - Straight Tail Version

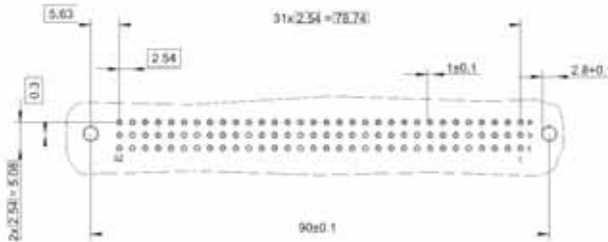

### Part Numbers

No. of Contacts	Contact Arrangement	Performance Level	Termination Methods						
32	Row a + c All Even Numbers	2	100-932-431	100-932-432	100-932-433	—	100-932-434	100-932-533	100-932-633
64	Row a + c	2	100-964-431	100-964-432	100-964-433	100-964-439	100-964-434	100-964-533	—
		3	—	100-964-452	100-964-453	—	—	—	—
96	Fully Equipped	2	100-096-431	100-096-432	100-096-433	—	100-096-434	100-096-533	—
		3	—	100-096-452	100-096-453	—	—	—	—

\*\* Printed Circuit Layout On Page XX

## Type C — Series 100

## Press Fit 64 and 96 Contact Female Connectors — Three Row

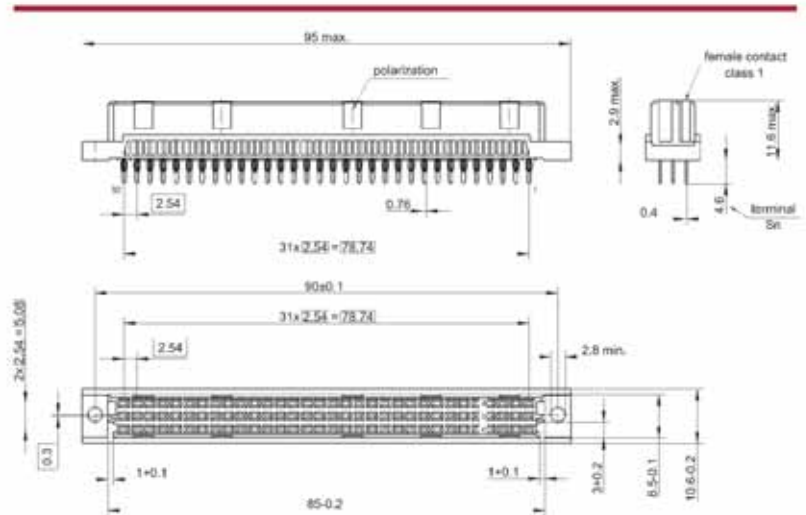

### Printed Circuit Layout

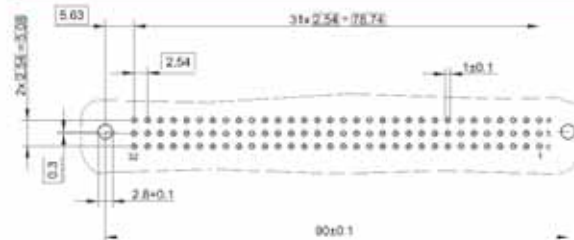

### Press-Fit Technical Specifications

Compliant Pin	
P.C.B. Thickness	.06 - .13 (1.6 - 3.2 mm)
Finished Hole Size	.037 - .043 (0.94 - 1.09 mm)
Drill Size	.045 ± .0004 (1.15 <sup>+0.01</sup> mm)
Copper	100μ" 300μ" (25-76μm)
Tin-Lead	30μ" (6μm min)

### Part Numbers

No. of Contacts	Contact Arrangement	Performance Level	Press-Fit		
64	Row a + c	2	100-964-932	—	—
96	Fully Equipped	2	100-096-932	100-096-931	100-096-939
		3	100-096-952	100-096-951	100-096-959

\* Contact Factory for Availability

## Printed Circuit Layout

### For Female Connectors With Angled Pins — Type 1/2B, 1/2C, B, and C

**RoHS  
Compliant**

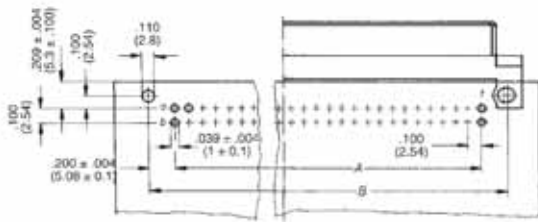

#### Two Row / 100-...-5.3

Type	Dimensions	
	A [mm]	B [mm]
1/2 B	15 x .100 = 1.500 (15 x 2.54 = 38.10)	1.900 ± .004 (48.26 ± 0.1)
B	31 x .100 = 3.100 (31 x 2.54 = 78.74)	3.500 ± .004 (88.90 ± 0.1)

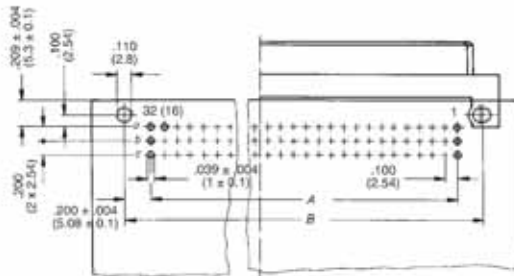

#### Three Row / 100-...-5.3

Type	Dimensions	
	A [mm]	B [mm]
1/2 C	15 x .100 = 1.500 (15 x 2.54 = 38.10)	1.900 ± .004 (48.26 ± 0.1)
C	31 x .100 = 3.100 (31 x 2.54 = 78.74)	3.500 ± .004 (88.90 ± 0.1)

#### Special Design

The center line of the mounting hole is in-line with the center-line of row a.

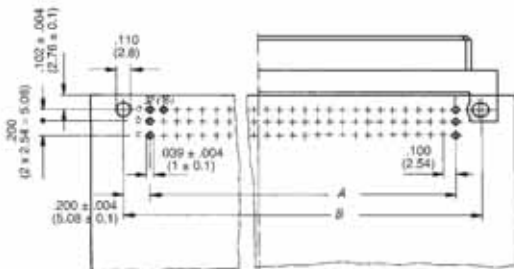

#### Three Row / 100-...-6.3

Type	Dimensions	
	A [mm]	B [mm]
1/2 C	15 x .100 = 1.500 (15 x 2.54 = 38.10)	1.900 ± .004 (48.26 ± 0.1)
C	31 x .100 = 3.100 (31 x 2.54 = 78.74)	3.500 ± .004 (88.90 ± 0.1)



## Type D — Series 100

## 32 Contact Male Connectors

RoHS  
Compliant

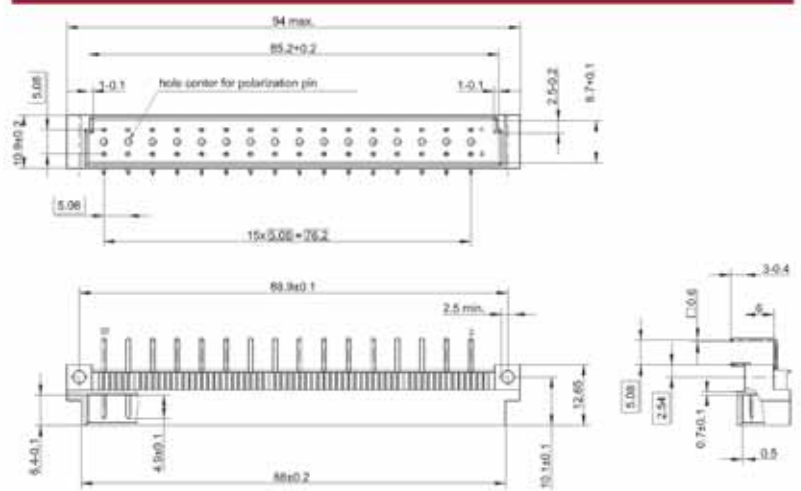

### Printed Circuit Layout

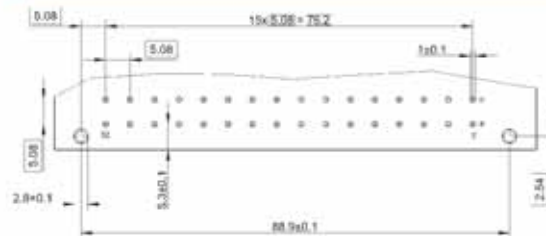

### Part Numbers

No. of Contacts	Contact Arrangement	Performance Level	Termination Methods
32	Fully Equipped	2	100-032-033

**Type D —  
Series 100**

**32 Contact Female  
Connectors**

**RoHS  
Compliant**

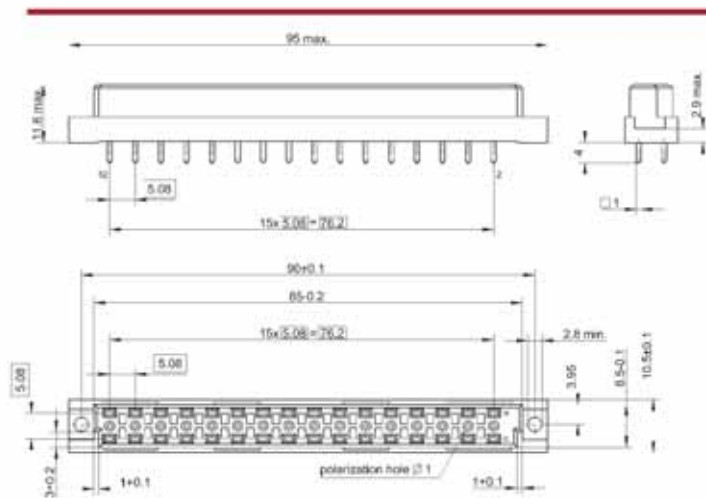

**Printed Circuit Layout**

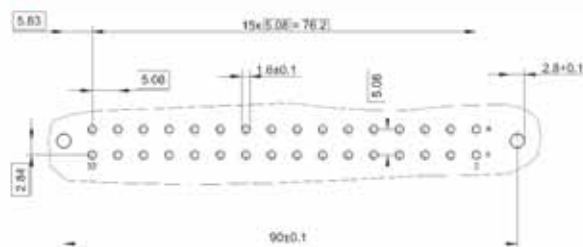

**Part Numbers**

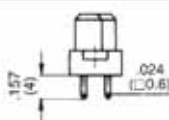
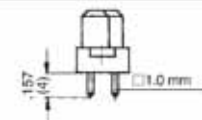
No. of Contacts	Contact Arrangement	Performance Level	Termination Methods	
				
32	Fully Equipped	2	100-032-432	100-032-438

## Type E — Series 100

## 48 Contact Male Connectors

**RoHS Compliant**

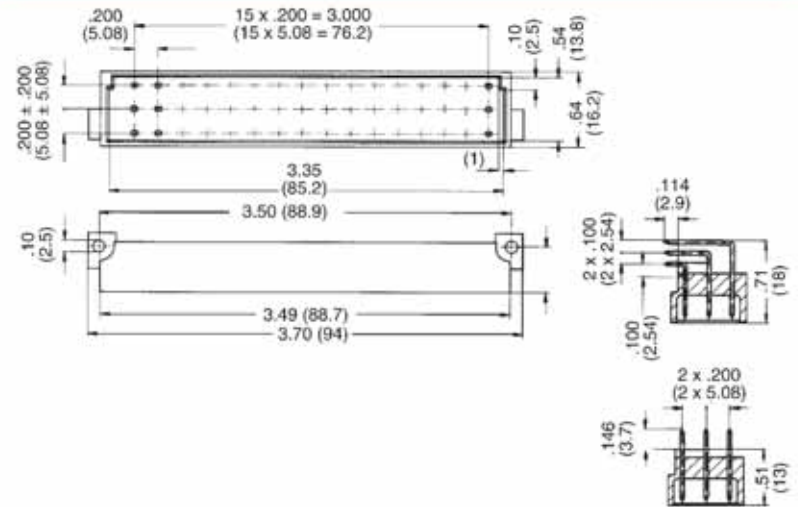

### Printed Circuit Layout - Right Angle Version

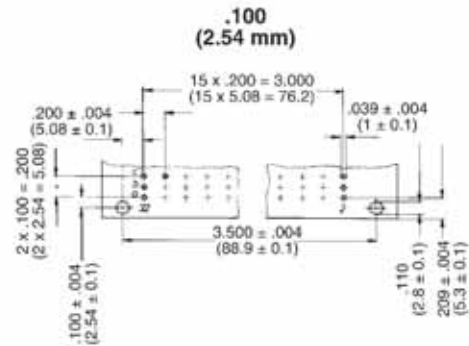

### Part Numbers

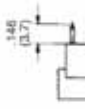
No. of Contacts	Contact Arrangement	Performance Level	Termination Method	
				
48	Fully Equipped	2	100-048-033	100-048-133

## Type E — Series 100

## 48 Contact Female Connectors

**RoHS  
Compliant**

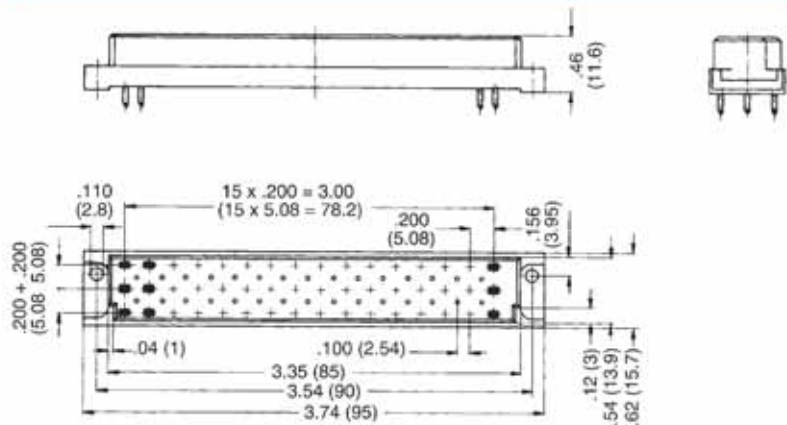

### Printed Circuit Layout

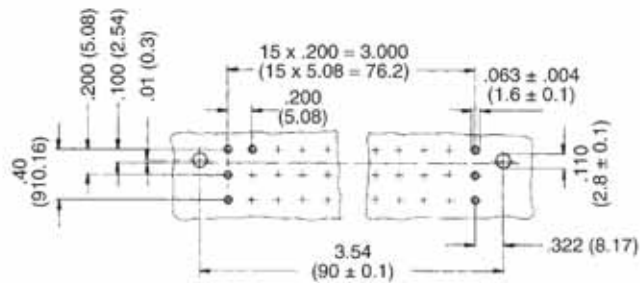

### Part Numbers

No. of Contacts	Contact Arrangement	Performance Level	Termination Method
48	Fully Equipped	2	100-048-438



## Type F — Series 101

## 48 Contact Male Connectors

**RoHS  
Compliant**

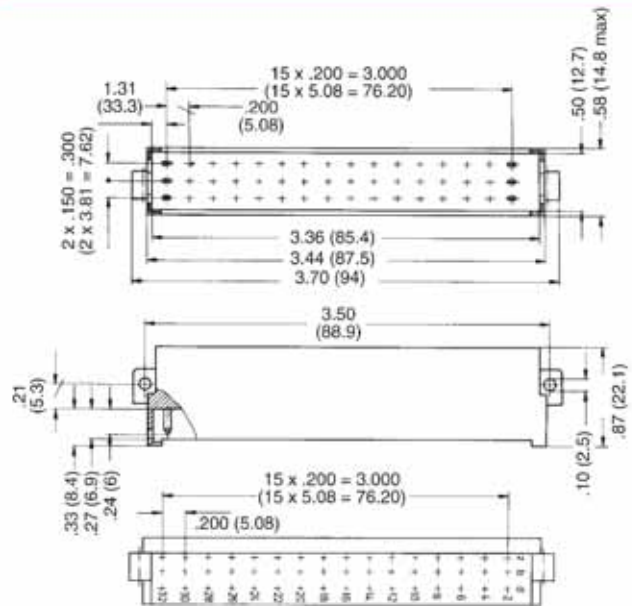

### Printed Circuit Layout

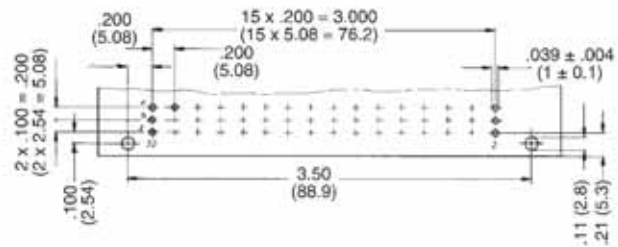

### Part Numbers

No. of Contacts	Contact Arrangement	Performance Level	Termination Methods
48	Fully Equipped	2	101-048-033

**Type F —  
Series 101**

**48 Contact Female  
Connectors**

**RoHS  
Compliant**

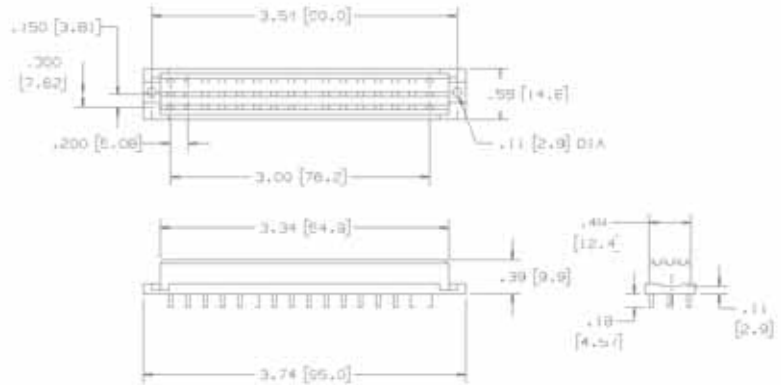

**Printed Circuit Layout**

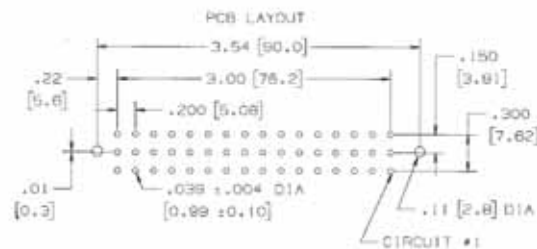

**Part Numbers**

No. of Contacts	Contact Arrangement	Performance Level	Termination Methods
48	Fully Equipped	2	101-048-438-LP

## Type C + 1 Series 106

## 128 Contact Male Four Row Connectors

**RoHS  
Compliant**

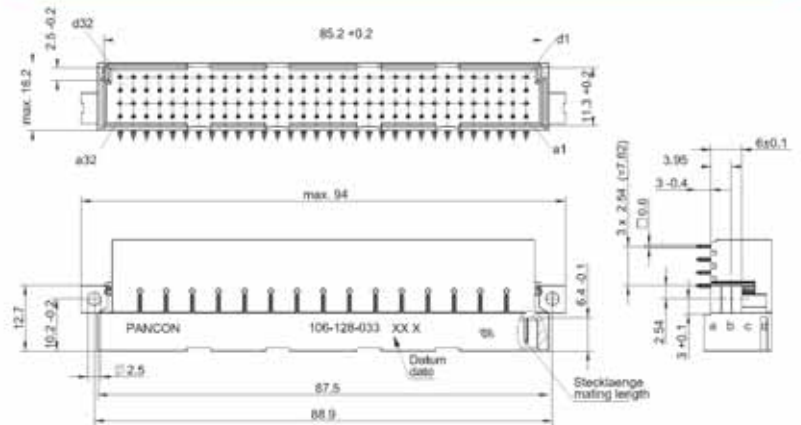

### Printed Circuit Layout

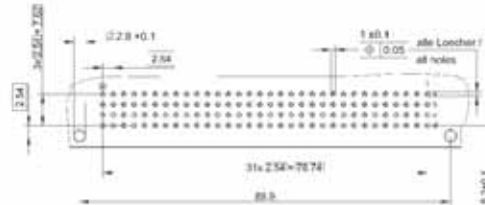

### Part Numbers

No. of Contacts	Contact Arrangement	Performance Level	Termination Methods
128	Fully Equipped	2	106-128-033

## Type C + 1 Series 106

## 128 Contact Female Four Row Connectors

**RoHS  
Compliant**

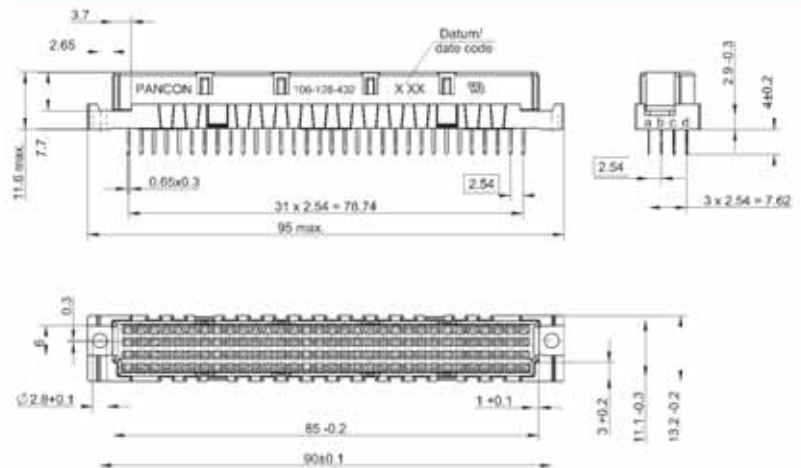

### Printed Circuit Layout

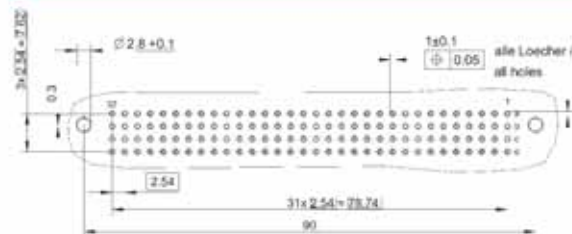

### Part Numbers

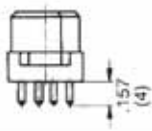
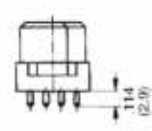
No. of Contacts	Contact Arrangement	Performance Level	Termination Methods	
				
128	Fully Equipped	2	106-128-432	106-128-433

\* Contact Factory for Availability







## Type 1/2 R Series 130

## 48 Contact Inverse Male Three Row Connectors

RoHS  
Compliant

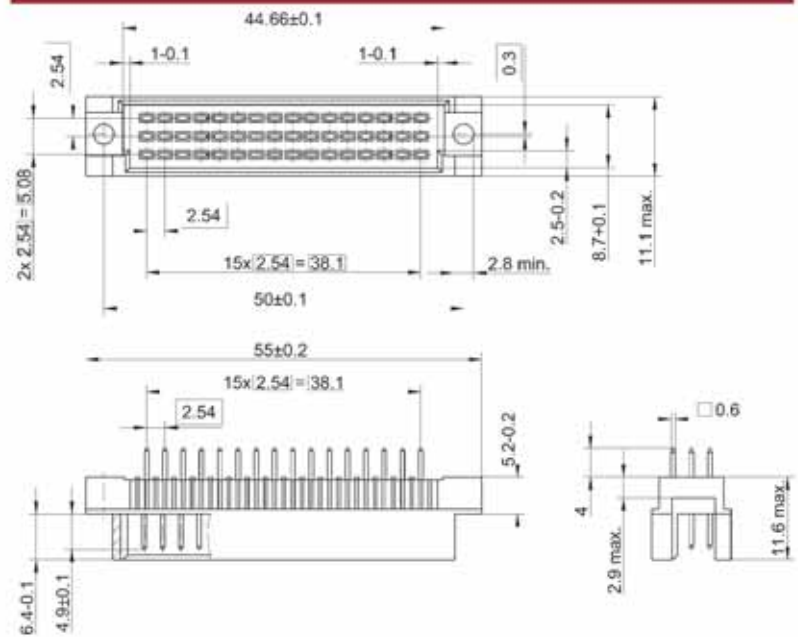

### Printed Circuit Layout

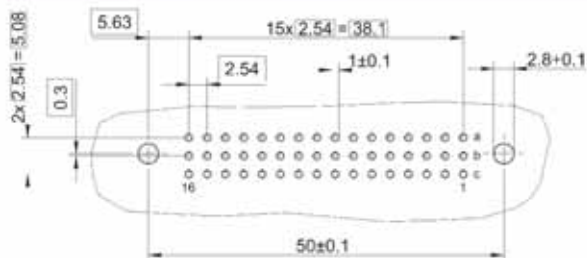

### Part Numbers

No. of Contacts	Contact Arrangement	Performance Press-Fit Level	Termination Method
			Soldering
48	Fully Equipped (Rows a + b + c)	2	
			130-348-133

\* Contact Factory for Availability

## Type 1/2 R Series 130

## 48 Contact Inverse Female Connectors — Three Row

RoHS  
Compliant

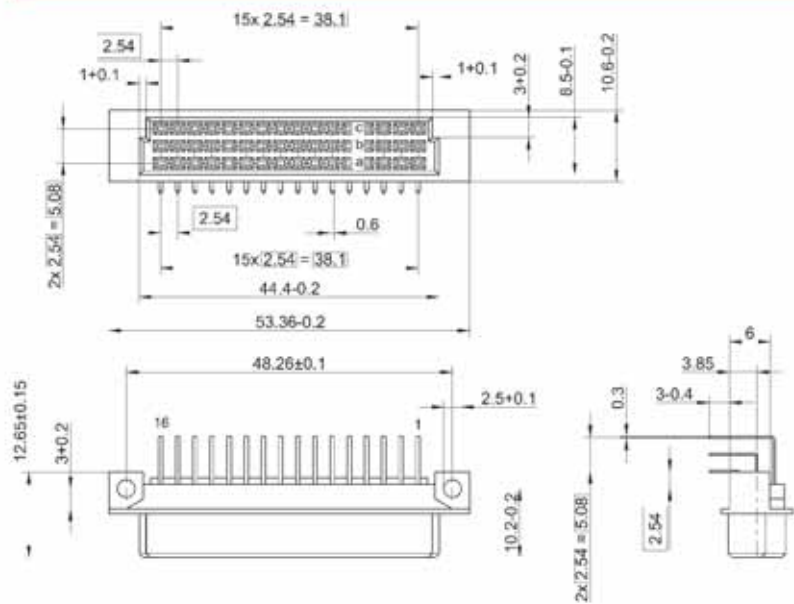

### Printed Circuit Layout

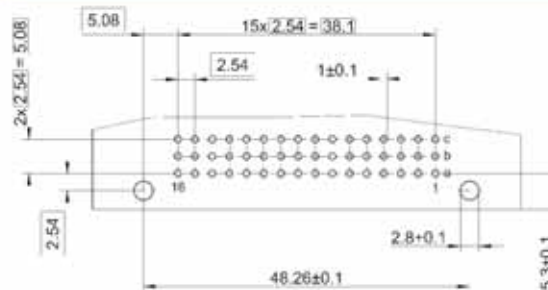

### Part Numbers

No. of Contacts	Contact Arrangement	Performance Level	Termination Methods
			<p>.114 (2.9)</p>
48	Fully Equipped (Rows a + b + c)	2	130-348-533
		3	130-348-553*

\* Contact Factory for Availability



## Type R — Series 130

## 64 and 96 Contact Inverse Male Three Row Connectors

RoHS  
Compliant

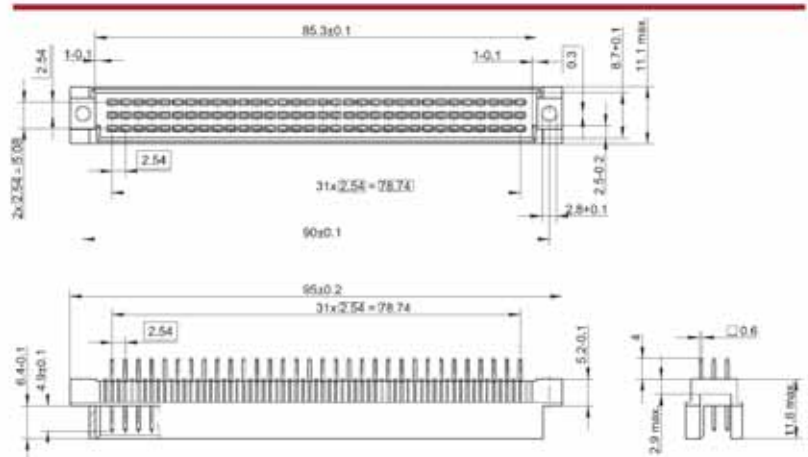

### Printed Circuit Layout

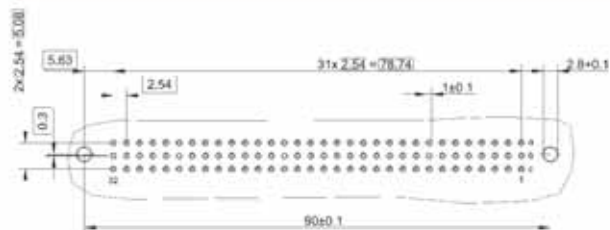

### Part Numbers

No. of Contacts	Contact Arrangement	Performance Level <sup>3)</sup>	Soldering	
64	Row a + c	2	130-964-133	
		3	130-964-153	
96	Fully Equipped (Rows a + b + c)	2	130-096-133	
		3	130-096-153	

\* Contact Factory for Availability

## Type R — Series 130

## 64 and 96 Contact Inverse Female Three Row Connectors

**RoHS  
Compliant**

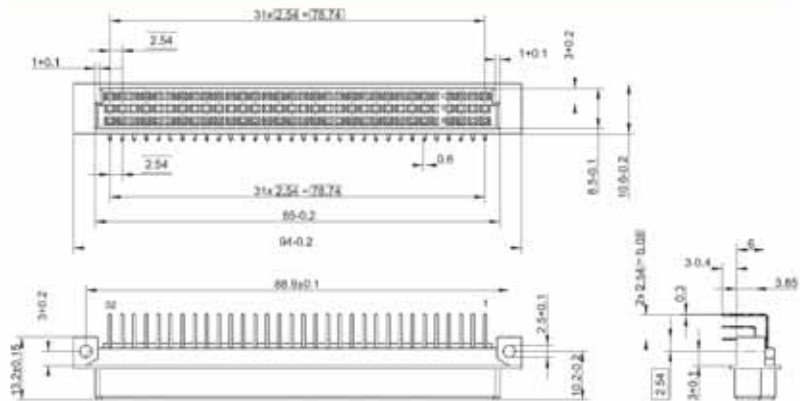

### Printed Circuit Layout

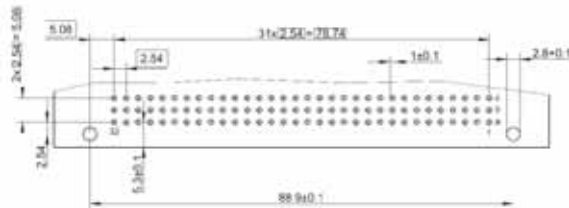

### Part Numbers

No. of Contacts	Contact Arrangement	Performance Level	Termination Methods
64	Row a + c	2	130-964-533
96	Fully Equipped (Rows a + b + c)	2	130-096-533



## Cable Housing

**For Type C, R, D, F —  
For Female and Male  
Connectors With Straight  
Terminations**

### Cable Exits

Cable exit, 2 round cable exits, to accept one cable of 11 mm  $\phi$  (.433"o)

Cable Support: The flange is provided with two cable clamps.

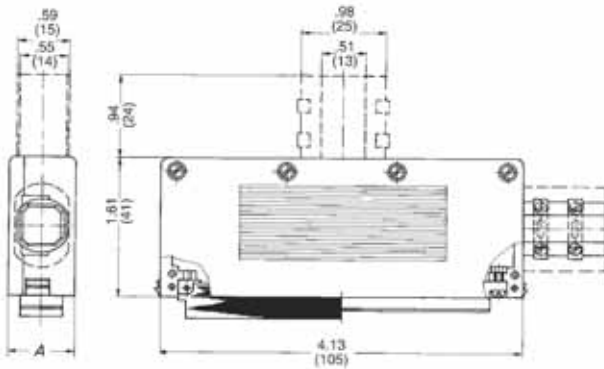

### Part Numbers

Style	Cable Housing for Connectors			
	C,R,D	Dim./ A [mm]	F	Dim./ A [mm]
	100-000-002	.59 (15 mm)	101-000-002*	.75 (19 mm)



### Part Numbers

Snap Wedges M and F for Male and Female Connectors		Part Numbers	Packaging Unit
		100-000-008	1 Set



## Accessories

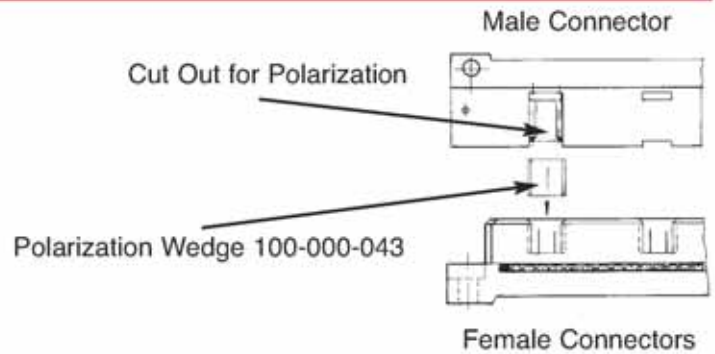
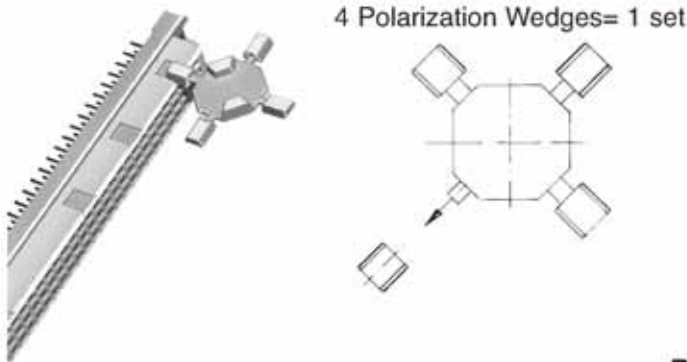

### Polarization Wedge

Polarization Wedge	Packaging Unit
100-000-043	25 Sets

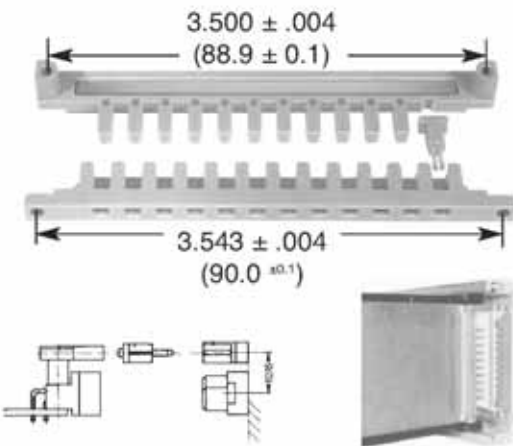

### Coding Comb set for type B, C, D, F, AND R

Polarization Wedge	Packaging Unit	Raw Material	Color
100-000-026	10 Sets	Glass Filled Polycarbonate	Red

### Mounting Clip for Male and Female Connectors

Series	Male Connectors	Female Connectors
100	1/2 B, 1/2 C, B, C, D	1/2 B, 1/2 C, B, C, D Straight
106	C + 1	C + 1

### Part Numbers

Mounting Clip	Series	P.C.B. Thickness
...B	100 to 130	1.6 mm

Complete part number — connector with clip  
please add suffix "B" or "C" Example. 100-096-433B

\*Please, contact factory for availability.

**Interface System  
for Front and Back  
Panel Applications**

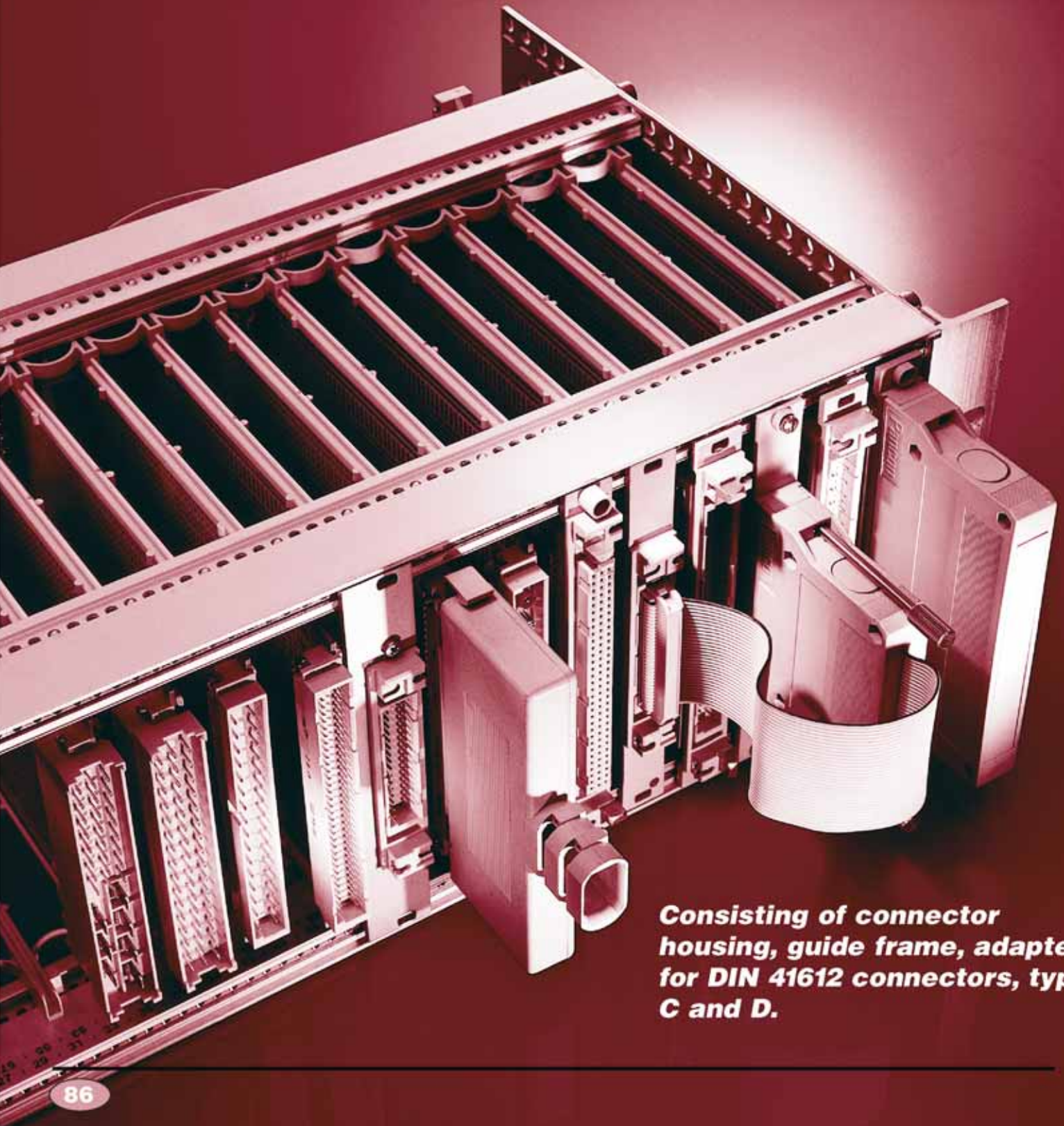

**Consisting of connector housing, guide frame, adapter for DIN 41612 connectors, type C and D.**



## Interface System for Front Panel Applications

### Interface System - Type C and D - Front Rack

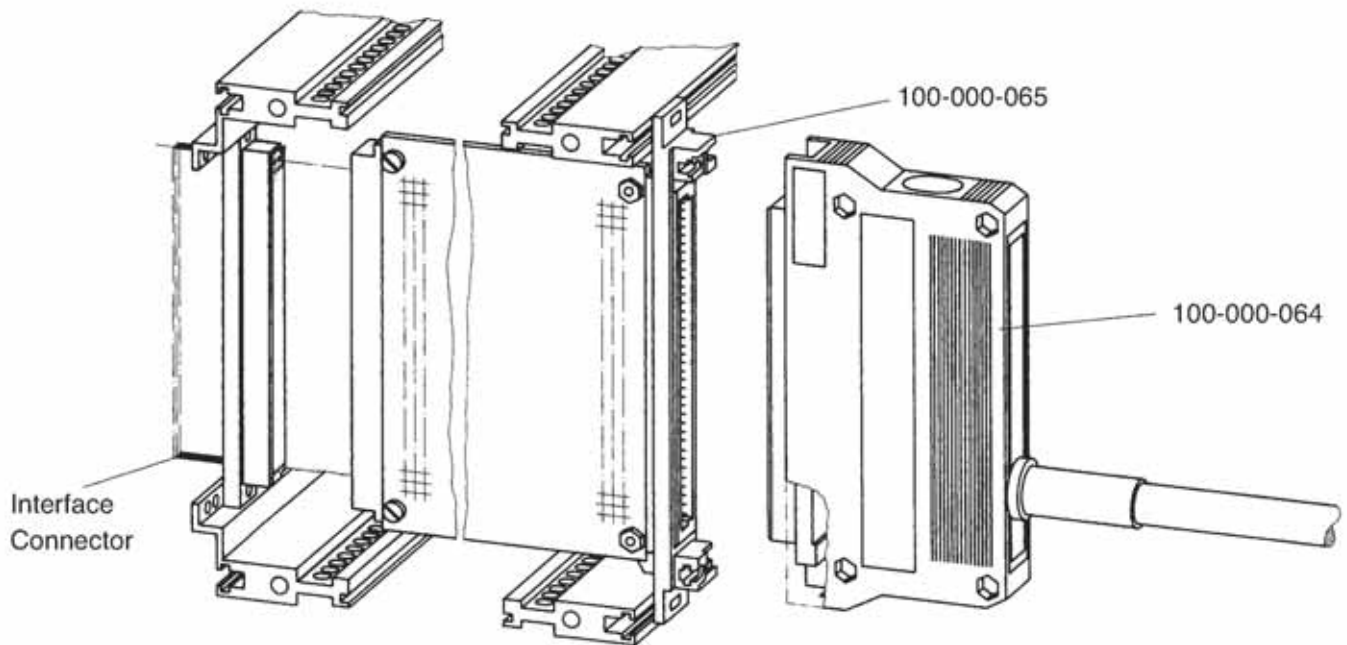

Front rack mounted male/female connector using guide-frame with flying lead female/male connector in housing.

**Interface System**

**Connector Housing for Type C and D**

Cable exit  
 ø .43 (ø 11 mm)  
 3 round cable exits,  
 1 flat cable exit

Locking mechanism  
 The mated housing  
 is secured by a  
 screw locking  
 mechanism

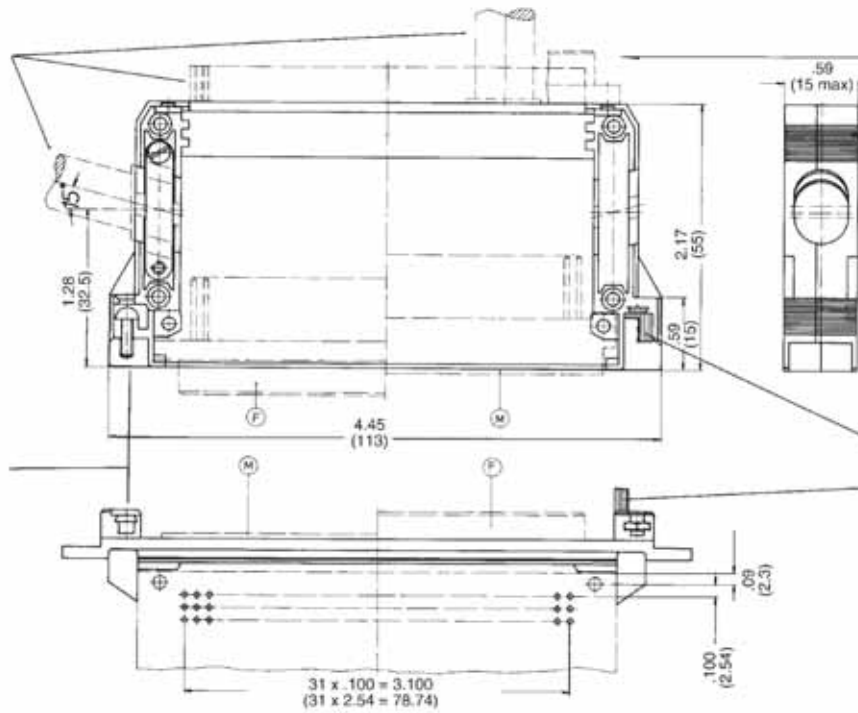

Mounting method  
 for female  
 connectors

Polarization  
 by insertable  
 wedges

**F = Female Connector / M = Male Connector**

**Part Number**

Connector Housing	Packaging unit		
100-000-064	1 Set		
Round Cable Insert	Packaging unit		
100-000-071	10 Sets		
Strain Relief	Packaging Unit		
100-000-072	10 Sets		



## Interface System

### Guide-Frame for Special Applications, Converter Frame for Type C and D

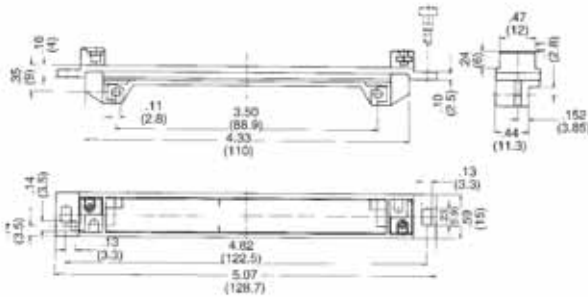

#### Part Number

Guide Frame	Packaging Unit
100-000-065	10 Sets
Pieces Per Set	1 Guide Frame
	2-Head Screws / M 2.5 x 13 DIN

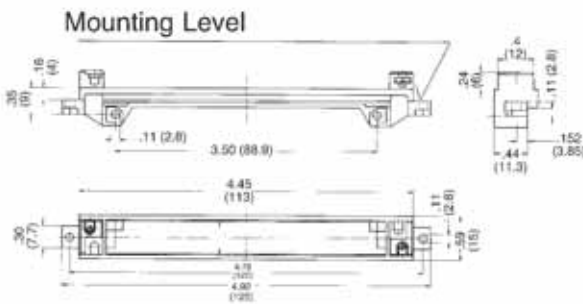

#### Part Number

Frame for Special Applications	Packaging Unit
100-000-066	10 Sets
Pieces Per Set	1 Frame for Special Applications
	2-Head Screws / M 2.5 x 13 DIN

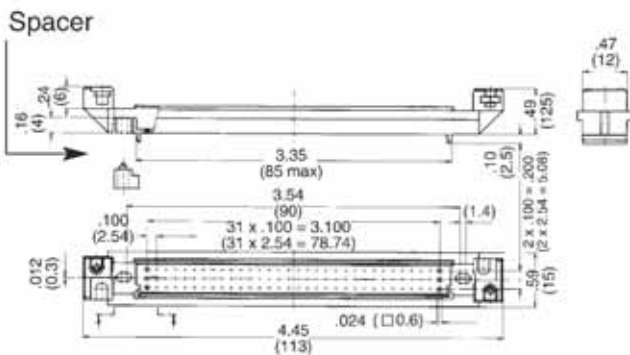

#### Part Number

Converter Frame, Type C	Packaging Unit
100-000-067	10 Sets
Pieces Per Set	1 Converter Frame
	2 Spacer .157 (4mm)
	2 Spacer .197 (5mm)
	2 Hexagonal Nuts

**Flat Cable  
Connector System  
Dimensions  
According to DIN  
41612**

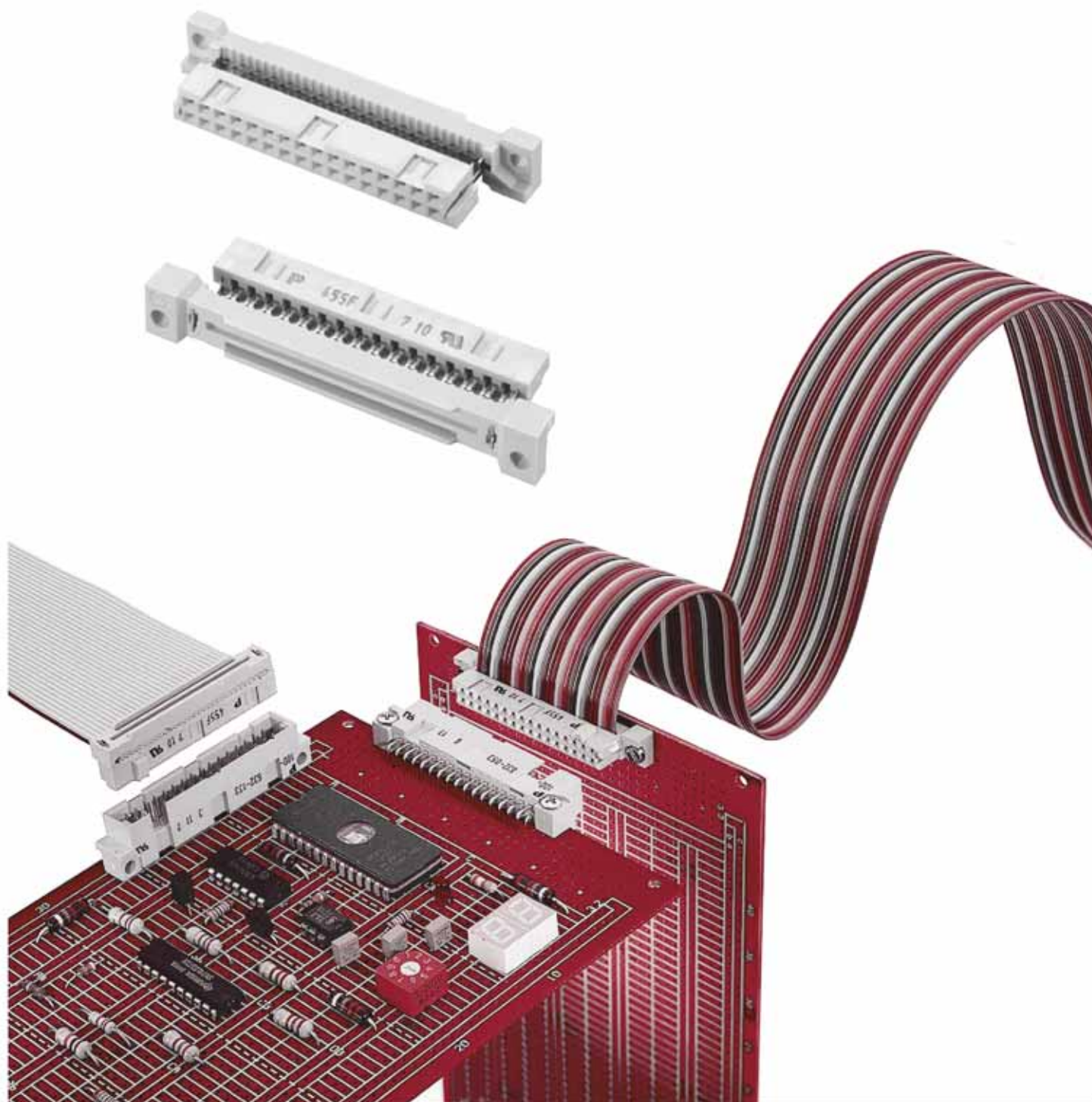

## Type 1/2 C — Series 120

## 32 contact male three row connectors Rows a + c Fully Loaded

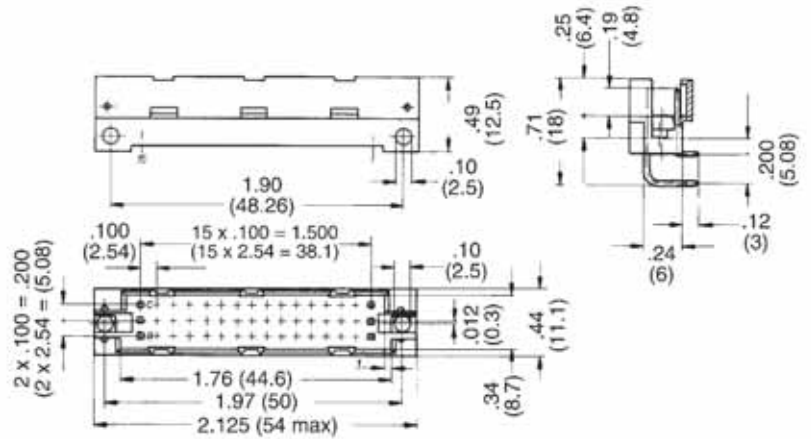
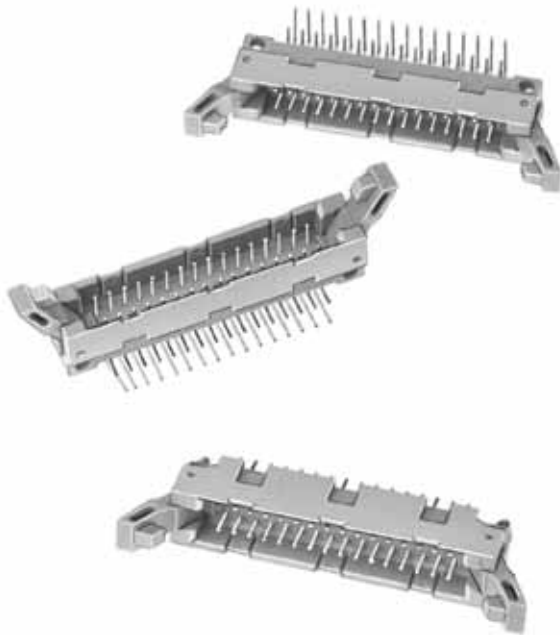

### Printed Circuit Layout / Dip Solder Angled

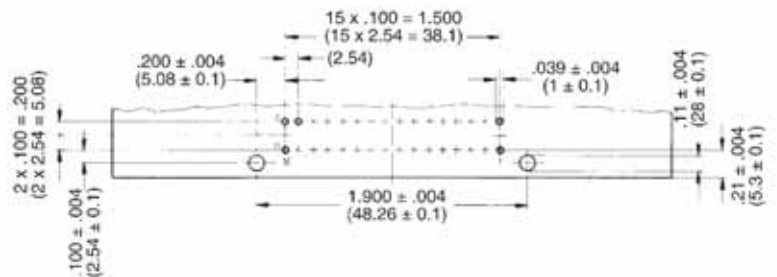

### Part Numbers

No. of Contacts	Performance Level	Style / Termination Methods
		<p>Dip Solder Angled</p>
32	2	120-332-033A*

\* Contact Factory for Availability



**Type 1/2 C —  
Series 120**

**32 Contact IDC  
Female Three  
Row Connectors  
Rows a + c Fully Loaded**

**RoHS  
Compliant**

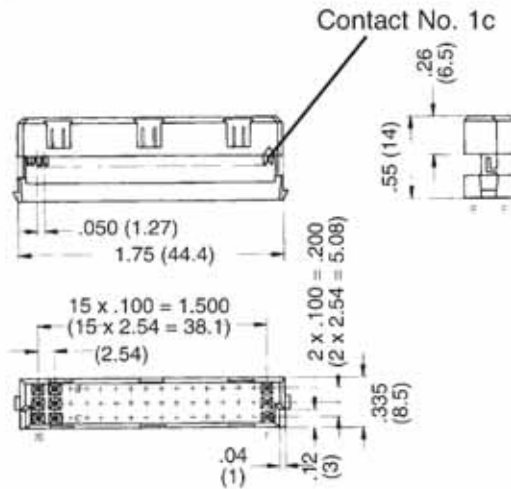

**With Mounting Flange**

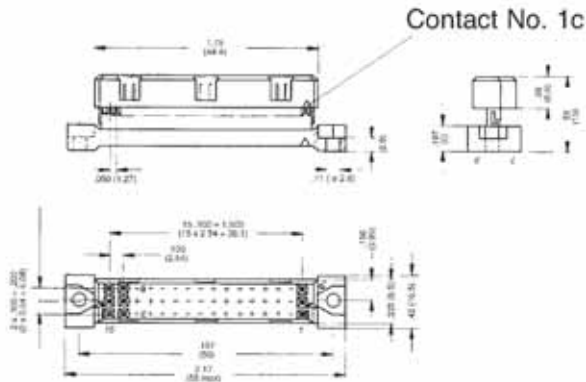

Intermateable with Connectors according to V6 95324

**Part Numbers**

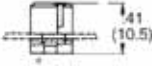
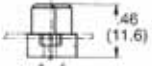
No. of Contacts	Performance Level	Style	
			
32	2	Through Connector 120-332-435	Through Connector with Mounting Flange 120-332-435F





## Type B and Series 120

## 64 Contact IDC Female Connectors— Two Row

**RoHS  
Compliant**

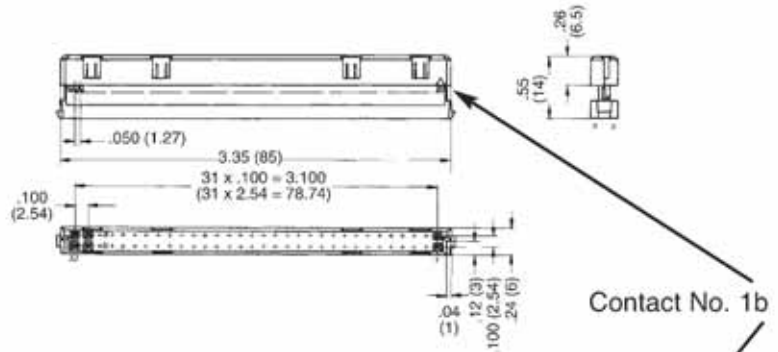

### Without Mounting Flange

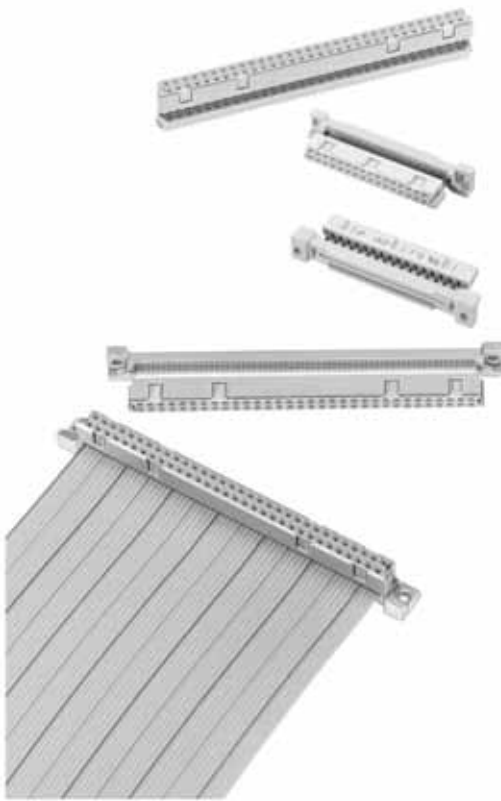
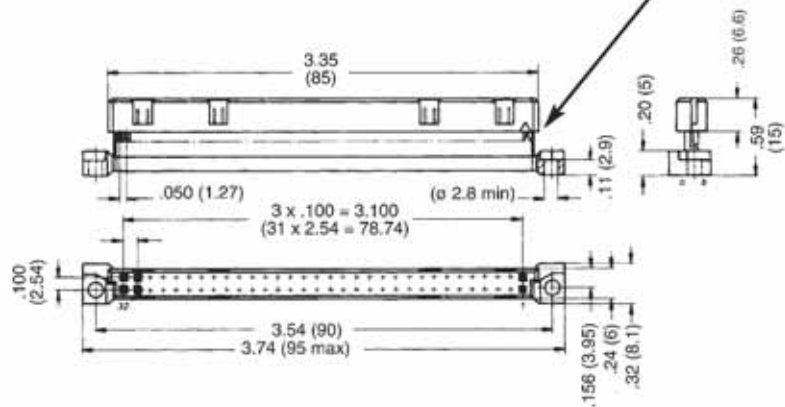

### With Mounting Flange

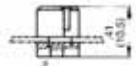

### Part Numbers

No. of Contacts	Performance Level	Termination Methods	
			
64	2	Through Connector	Through Connector with Mounting Flange
		120-064-435	120-064-435F

## Type C — Series 120

## 64 Contact Male Connectors — Three Row

**RoHS  
Compliant**

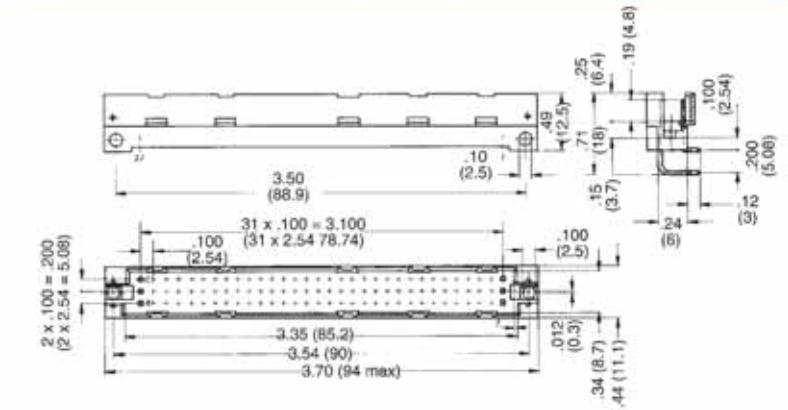

**Printed Circuit Layout / Dip Solder Angled**

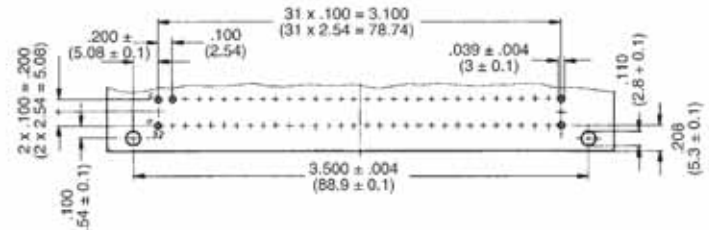

**Printed Circuit Layout / Dip Solder Straight**

Male connectors without locking lever see page #.

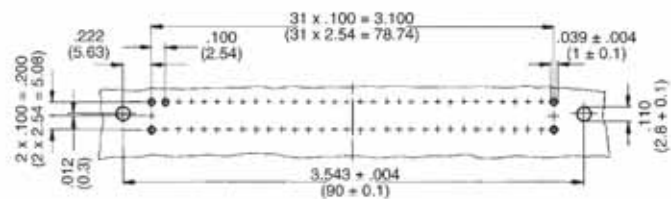

### Part Numbers

No. of Contacts	Performance Level	Style	
64	2	Dip Solder Angled 120-964-033A	Dip Solder Straight 120-964-133A

Without ejector 120-064-... (without Suffix-A)\*

\* Contact Factory For Availability

## Type C — Series 120

## 64 and 96 contact IDC female connectors - three row

RoHS  
Compliant

### 64 Contacts

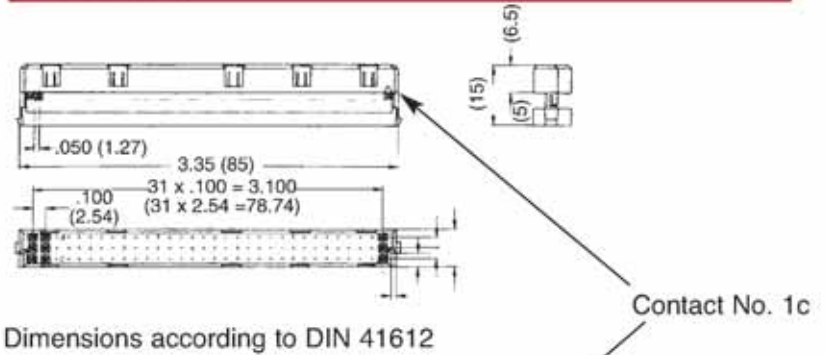
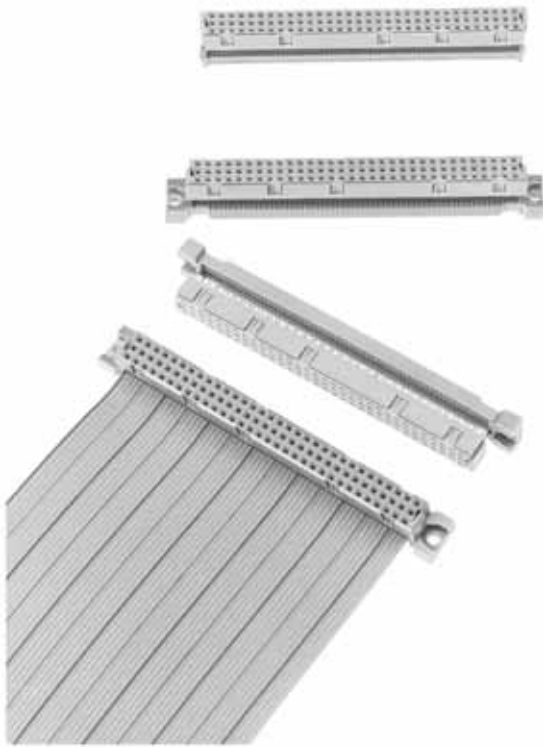

### 96 Contacts

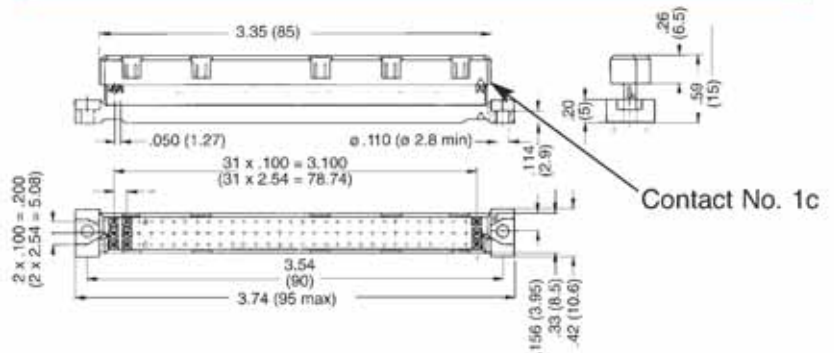

### Part Numbers

No. of Contacts	Contact Arrangement	Performance Level	Style	
			Connector	Connector With Mounting Flange
64	Row a + c	2	120-964-435	120-964-435F
96	Fully Equipped	2	120-096-435	120-096-435F**

\*\* 96 Contact Version Uses .033" Pitch Flat Cable.



## Accessories Series 120 Tooling and Accessories

Housing for female connectors type C			
100-000-064			
Strain relief for C housing			
100-000-072			
Polarization wedge	Packaging unit	1 set =	Male connector - cut out for polarization Female connector
100-000-043	25 sets	4 wedges	100-000-043 100-000-042
Strain relief bracket for female connectors	Type	Dimension A	Packaging unit
120-000-032	B + C 64 contacts	3.25 (82.6 mm)	10 pcs.
120-000-042	1/2 C	1.79 (45.6 mm)	10 pcs.



### Cable Bushing

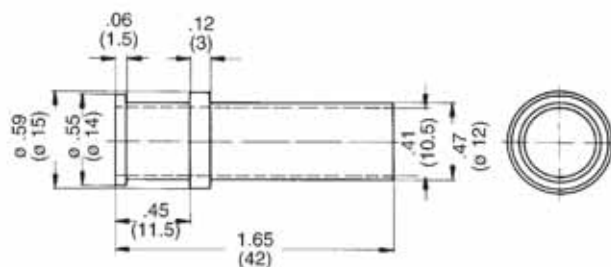

### Part Number

Cable Bushing	Packaging Unit
100-000-014	10 Pieces

## Pan-Flex Flat Cable For Use With 120 Series IDC Connectors



### PAN-FLEX™ / Flat cable (UL Style 2651)

32 and 64 conductors

96 conductors

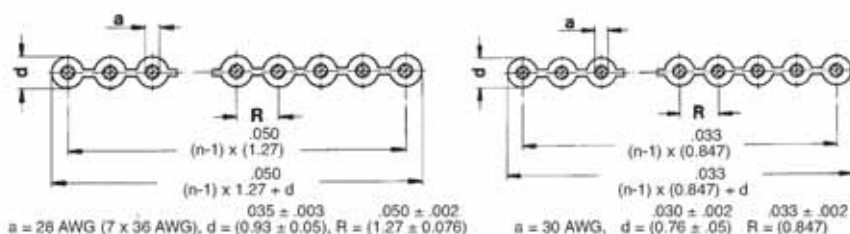

### Part Numbers

Conductors	only 1st conductor is color-marked	per reel
32	050F28V32CR	100 ft (30.48 m)
64	050F28V64CR	
96	033F30V96CR	

Conductors	32, 64	96
Conductors	tinned	
Insulation	PVC grey (RAL 7032)*	
Conductor resistance	≤ 230 Ω/km	
Insulation resistance	≥ 90 x 10 <sup>9</sup> Ω/km	
Capacitance	56 pF/m	83 pF/m
Voltage rating	300 V	150 V
Temperature rating	-020°C/ + 105°C	

## Part Number System

**100 - 064 - 0 5 3**

Series	Type	Code
Series	Type B, 1/2 B, C, 1/2 C, or D	100
	Type C + 1 (4 row DIN)	106
	IDC DIN, Type B or C	120
	Type Q, 1/2 Q, R, or 1/2 R (inverse)	130

### Contact arrangement/No. of contacts

Type D, 32 contacts	032
Type B, 64 contacts	064
Type C, 64 contacts, rows a & c	964
Type C, 96 contacts	096
Type C + 1, 128 contacts	128
Type 1/2 C or 1/2 R, 48 contacts	348
Type 1/2 B or 1/2 Q, 32 contacts	632

Tail Length	Value	Code
13,0 mm		1
4,0 mm		2
2,9 mm		3
17,0 mm		9

DIN Performance level	Value	Code
Performance level 3		5
Performance level 2		3

Male connector	Value	Code
Angled pins		0
Straight pins		1
Straight press fit		3

Female connector	Value	Code
Straight tail		4
Angled Tail		5
Straight press fit tail		9

## CSF Series Switch Connectors

Pancon Connectors SWITCH-CON CSF switch connectors provide a fast and practical one-piece alternative to discrete wire termination. The combination of convenient slip-on switch connection and reliable IDC wiring reduces both assembly time and number of components.

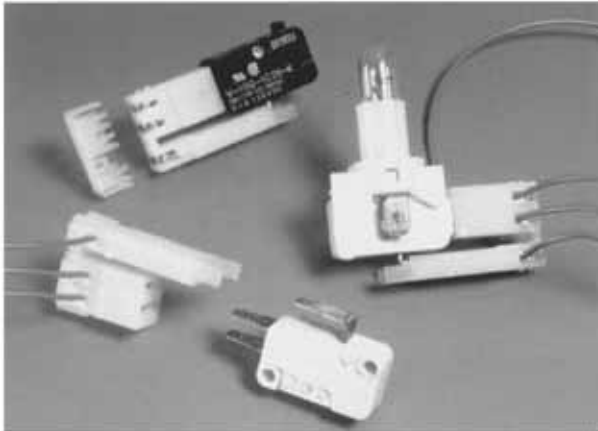

### Applications

CSF Connectors are convenient and fast, and they incorporate proven dual IDC contacts for 4 gas-tight contact areas per conductor. CSF assembly means no soldering, no wire twisting, and no mechanical devices.

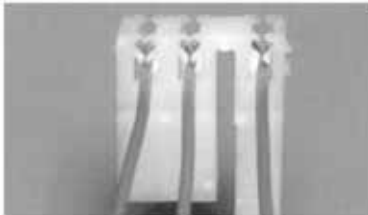

A Single CSF Connector reduces assembly time by using mass termination and eliminating the need for three individual wire-crimp, push-in terminals and, once installed, it provides single plug convenience for easy maintenance or repair.

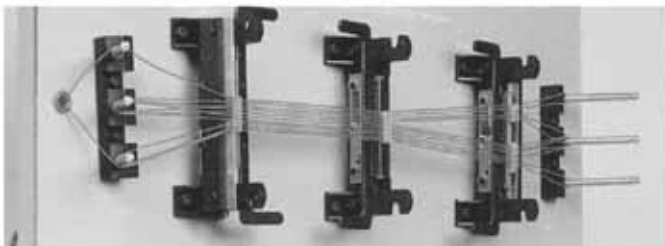
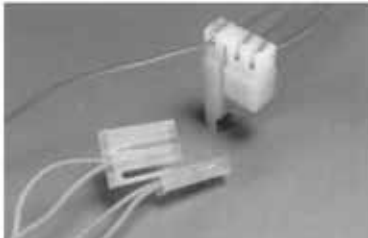

### Applications

Series CSF Connectors are designed to mate with popular miniature snap-action switches such as Cherry D4, Omtron V-106 and Microswitch V3 having .187" x .020" tabs for quick connect connections

### Features

#### Unique section

- Unique housing design flexes to mate with tabs on similar design switches from different manufacturers.
- Mass termination - terminate up to 4 connectors at once utilizing our unique PPHT - tool system.
- reliable and fast IDC one-time wiring
- Housing and contact design allows for "end" or "Through" terminations providing more Versatile harnessing options. Eliminates the need for double wire clamp
- Single plug convenience for easy on easy off maintenance - eliminates miswiring with single disconnect.
- Housing is color coded indicating wire gage
- Cover provides added strain relief if desired.

### CONNECTOR ORDERING INFORMATION

**CSF-XX-03-XX**

Connector Switch Female

Wire Gage (Color I.D.): 18 Orange, 20 (Brown) or 22 (Red)

01=With Shroud  
02=No Shroud

No. of Contacts

### COVER ORDERING INFORMATION

**CSC-XX**

Connector Switch Cover

Wire Gage: 18, 20 (used for 20 & 22 AWG)



## CSF Series Switch Connectors

**RoHS  
Compliant**



### PRODUCT DIMENSION

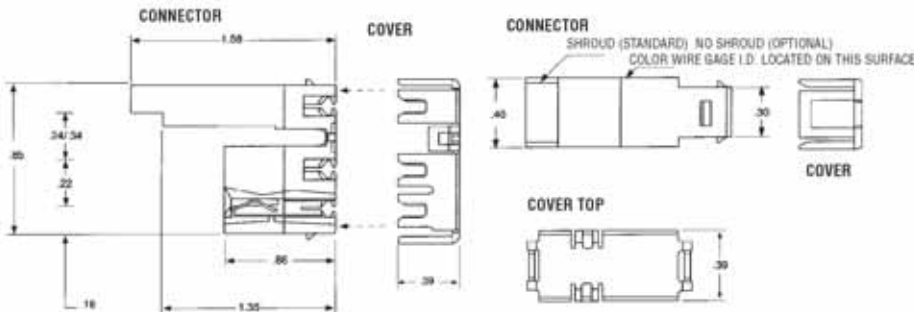

### TOOLING ORDERING INFORMATION

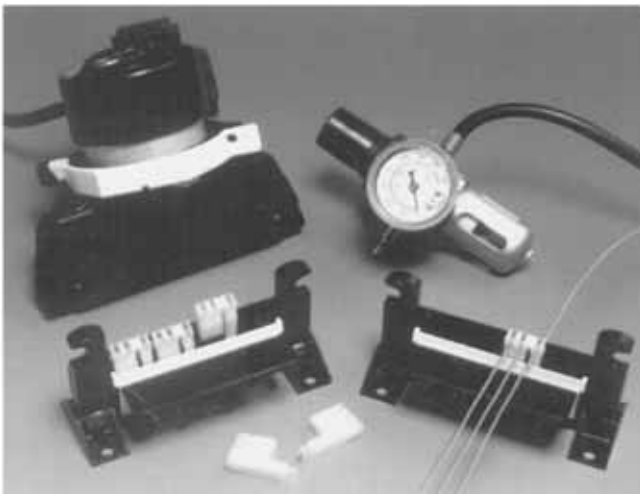

Part Number	Description
PPHT-CSF-E	End Fixture for CSF Connector
PPHT-CSF-C	Cut-off (selective) Fixture for CSF Connector*
PPHT-CSF3	Pneumatic PPHT Gun for CSF Connector
MRT-CSF	Manual Repair Tool

\* Factory can supply fixture modified to customer requirements

### MATERIALS

#### Housing and Cover

nylon 6/6 natural

#### Flammability

U.L 94 V-2

#### Contact

Phosphor Bronze

#### Plating

100U" Tin 50u Nickel

### ELECTRICAL

#### Current Rating

18 AWG-10 Amps

#### Dielectric Withstanding Voltage

3.8 KVCA min.

#### Insulation Resistance

5,000 Megaohms min.

### TEMPERATURE

#### Range

-67 °F to 185 °F

(-55 °C to 85 °C)

### MECHANICAL

#### Wire Style Max Wire O.D., .095"

PVC-UL styles 1007, 1015, 1061,

1095, 1429, 1430 as well as

MIL-W-16878D type C.

Teflon= MIL-W-16878 E 148

UL styles 1213

Type G MIL-16878 e16 type ET,

MIL-W-16878 type K & KT

#### Mating Force

with .020 thick tabs-8lbs.

#### Unmating Force

With .020 thick tabs-8lbs.

#### Wire Retention

W/O cover 18 gage parallel pullout—  
20 lbs. per wire

w/cover 18 gage perpendicular  
pullout—18 lbs. per wire

## Product Data Sheet

Part Number	Threaded Insert	No. of Circuits	DIM A	Plating
PPT-632	6-32	10	.472"	TIN
PPT-632-6	6-32	6	.322"	TIN
PPT-632-6-G	6-32	6	.322"	GOLD
PPT-M4	M4	10	.472"	TIN
PPT-M4-6	M4	6	.322"	TIN
PPT-M4-6-G	M4	6	.322"	GOLD
PPT-832*	8-32	10	.472"	TIN

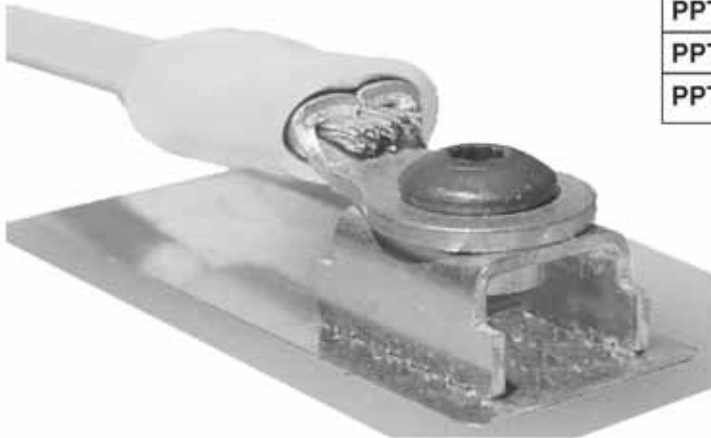

**RoHS  
Compliant**

### Features

- Designed to bring power to printed circuit boards
- Allows wire board connection using common ring or fork terminals
- 6/32 threaded steel insert staked in place
- 10 press fit pins (2 rows of 5)
- Maximum current carrying capacity: 40 amps at 600 volts
- No special tool required for insertion into PC board
- For printed circuit boards 3/32 and thicker

### Materials

- Contact: Phos. Bronze
- Insert: steel
- Plating: 100/150 microinches tin over 50 microinches nickel

### Electrical

- Current carrying capacity (determined by PCB and wire termination) 40 amps max. @ 20° C
- Rated current circuit resistance= <10 milliohms

### Mechanical

- Maximum PCB insertion force: 400 lbs.
- Minimum PCB retention force: 80 lbs.
- Minimum threaded insert torque-out: 19 inch pounds

### Ordering Information

- Part number: PPT-632
- Contact factory for price and delivery

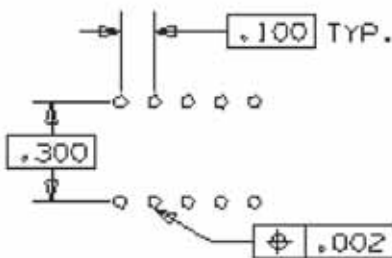
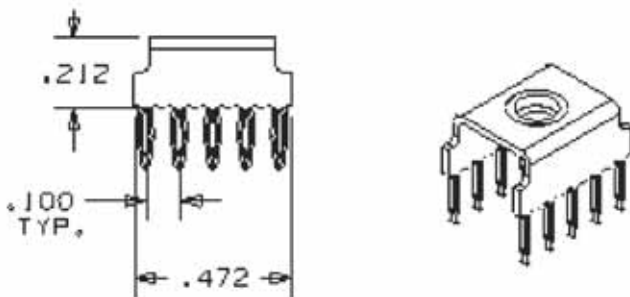

RECOMMENDED PC HOLE PATTERN

RECOMMENDED PC HOLE SIZE  $.040 \pm .003$ .

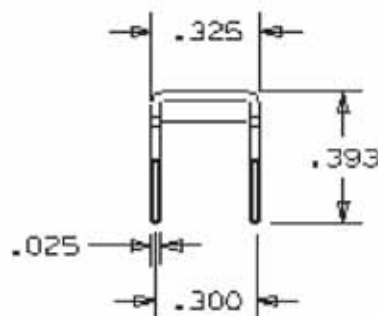
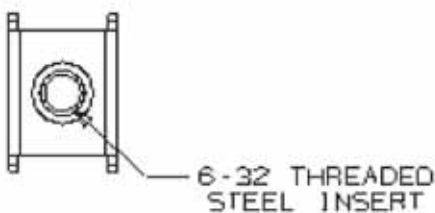

## **.110 Tab Crimp Style**

The .110" Tab SWITCH-CON provides a fast and reliable alternative to conventional quick disconnects. The convenient right angle crimp contacts may be used stand-alone or with custom housings for Customer specific applications. When paired with a custom housing, the .110 Tab Switch-Con provides a connection that is easy to assemble and easy to install saving assembly and testing costs.



**CSM-MH-06-02  
6 Positions Housing**



**CRSW22SD  
Crimped Contact**

**RoHS  
Compliant**

### **APPLICATIONS**

.110 Tab Switch-Con contacts may be used with industry standard .110 tabs in a variety of applications such as: switches, lamps, coils, relays, timers, motors, solenoids, etc. When inserted into a custom housing, the contacts offer more reliable connections doing away with the problem of installing the wrong wire on a tab. The top photo shows a typical Customer specific application of 6 contacts mating with a lighted pushbutton switch with ground. **Contact the factory for custom housing requirements, or tab configurations.**

- Contacts (CRSW22SD) may be used on .110 Tabs in a variety of applications.
- Custom housings can be built to group the contacts for ease of assembly. Contact the factory for quotations.
- The contacts are supplied on 24 inch reels for use with the automatic applicator (CACSF-22).
- Loose piece contacts are available for field repair applications using the HTCR-110-22 hand tool.
- Available tooling includes an applicator (CACSF-22) which is a mini-die format for use in industry standard presses which allow up to 2 wires to be terminated at a time, a hand tool (HTCR-110-22) for field repair, and an extraction tool (ECTR-110) for removing the contacts from housings.
- Contacts are easy to terminate, install, and assemble using standard equipment saving money on testing costs and assembly costs.

### **CONTACT ORDERING INFORMATION**

**.110 Tab Crimp Contact**

**CRSW 22 SD**

- Contacts on Reels of 4,500 Pieces
- For Loose Piece Contact Factory

**Wire Gage 22 AWG**

Consult factory for additional wire gauge availability



## **.110 Tab Crimp Style**

### **APPLICATOR TOOL**

Part Number: **CACSF-22**

- Feeds contact from left to right
- Mini-die format for use in industry standard presses
- Specify 30mm or 40mm stroke
- Specify manual or automatic feed

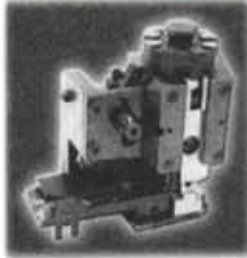

### **HAND CRIMPING TOOL**

Part Number: **HTCR-110-22**

- For use in field repair



### **CONTACT EXTRACTION TOOL**

Part Number: **ECTR-110**

- Extraction tool allows removal of contacts from custom housing



### **MATERIALS**

**Custom Housing**

Nylon 6/6 natural

**Flammability**

UL 94 V-2

**Contact**

High Tensile Brass

**Plating**

100μ" Tin 50μ Nickel

### **ELECTRICAL**

**Current Rating**

22 AWG-6 Amps

**Dielectric Withstanding Voltage**

3.8 KVCA minimum

**Insulation Resistance**

5,000 Megaohms min.

### **TEMPERATURE**

**Range**

-67 °F to 185 °F

(-55 °C to 85 °C)

### **MECHANICAL**

**Recommended Wire**

1 or 2 wires

22 AWG Stranded

Max. O.D. of .062"

**Mating Force**

with .020 thick tabs

(.5 - 1.8 LB/Circuit)

**Unmating Force**

With .020 thick tabs

(.2 - 1.8 LB/Circuit)

**Wire Retention in Contact**

8 LB/Wire

**Contact Retention**

5 LB/Circuit

### **AGENCY RECOGNITION**

**Underwriters Laboratories**

UL Recognized File No. E73711





**.110 Tab  
Crimp Style**

**RoHS  
Compliant**

## HOUSING ORDERING INFORMATION

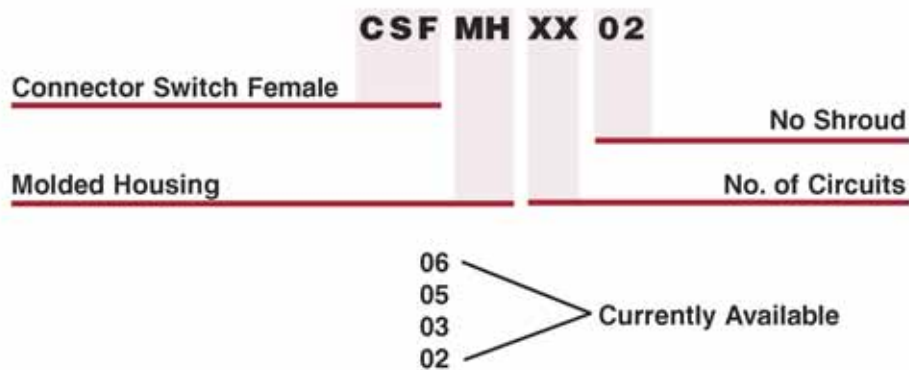

- Custom Housings May Be Built to Customer Specifications
- Contact the Factory to Discuss Specific Needs.



CSF-MH-02-02 on  
A Button Switch

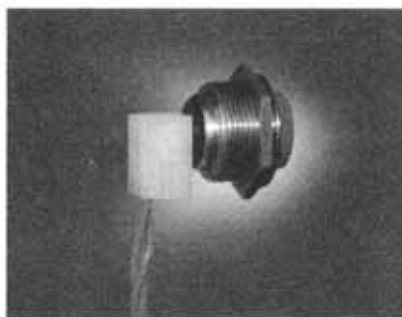

CSF-MH-02-02 on A ITW 76-59  
or 49 Series Switch



CSF-MH-03-02  
on A DB5 Switch

## .187 and .250 Tab Crimp Style

Pancon Connectors is introducing our new Crimp Style contacts and housings for .187" and .250" tabs. These are more than just replacements for single disconnects. We offer the .187" for gaming and vending switch and motor applications. The .250" are designed for appliance industry applications. The unique, patented design allows for more consistent insertion and withdrawal forces. As with the .110" contacts, we develop Customer specific housings to fit exact needs.

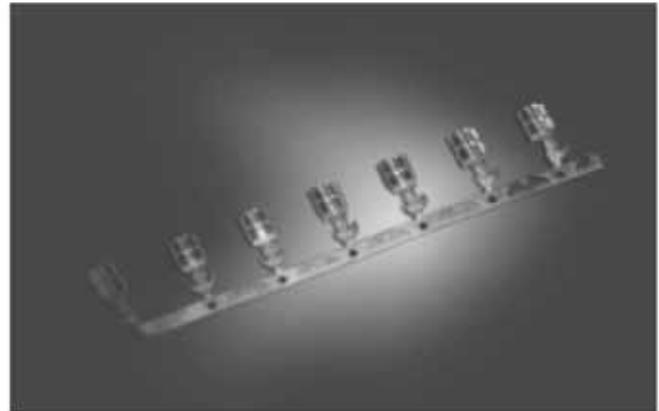

### ORDERING INFORMATION

---

Tab Crimp Contact	<b>CRSW</b>	<b>187</b>	<b>22</b>	<b>SD</b>	<b>- L</b>	Loose Piece *Option
Tab Size - 187, 250						Standard – S Dimple – SD
						Wire Gage 22 AWG

\*Contact factory for additional wire awg availability

### HOUSING ORDERING INFORMATION

---

\*Contact factory for custom housing configurations

## .187 Tab Crimp Style E Series Switch Connector Housings

**RoHS  
Compliant**

The E Series Connector Housings are designed to accept our CRSW187... Tab Crimp Contacts and mate with the popular Cherry E Series single and double pole, panel mount, pushbutton switches.

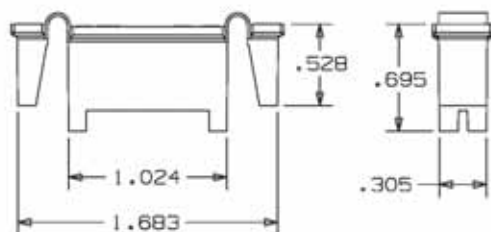
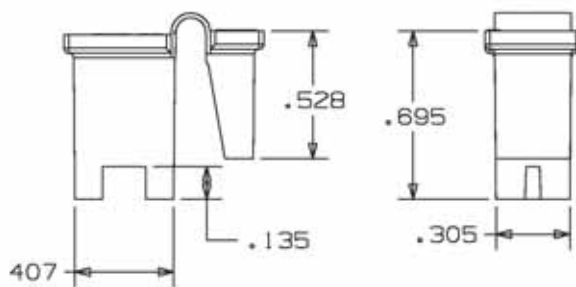
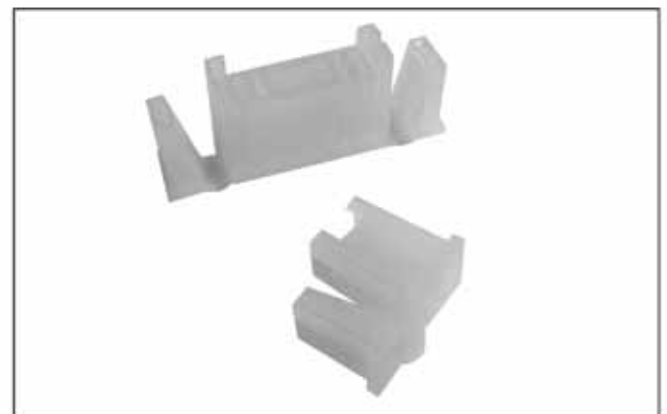

### **HOUSING ORDERING INFORMATION**

- 3 Position Housing - CSF-187-E3
- 6 Position Housing - CSF-187-E6

# New Products

## Jumper-Switch™

RoHS  
Compliant

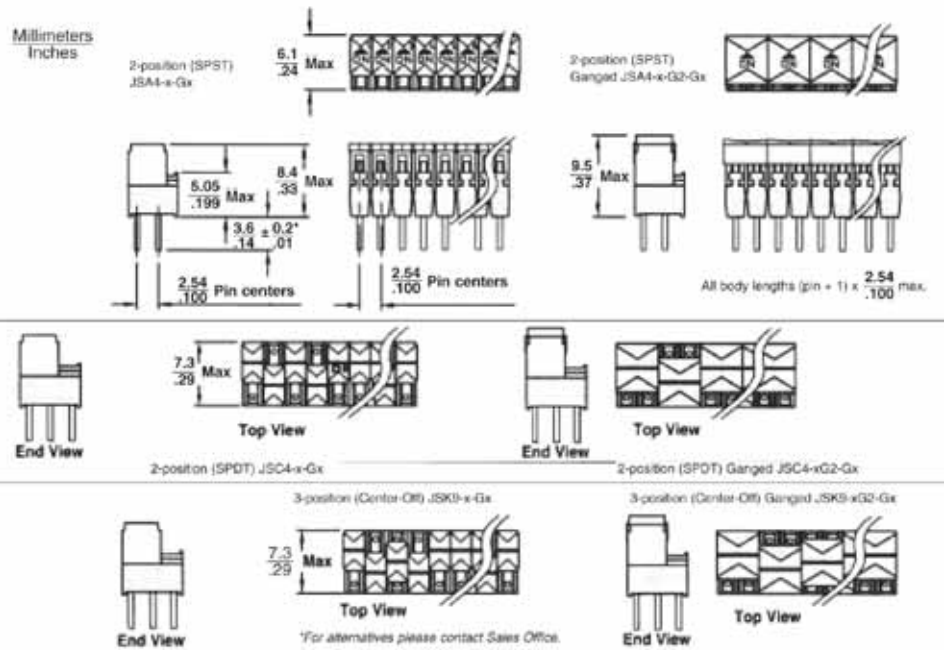
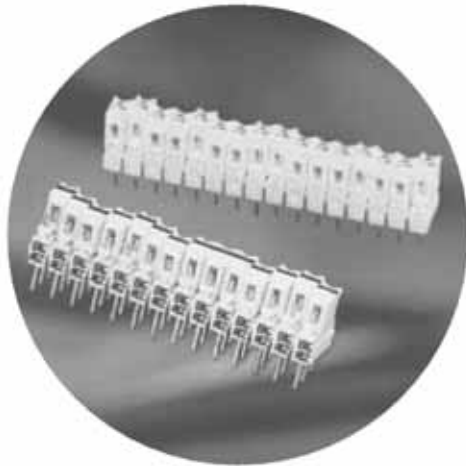

### ORDERING INFORMATION

	JS	A	4	8	G0	
Jumper-Switch™						Gold Thickness (Standard 0.1µm) G0 (Special 1.0µm) G1
2 rows of pins – 2 position (SPST)	A					Optional – numbered actuators N
3 rows of pins – 2 position (SPDT)	C					
3 rows of pins – 3 position (center-off)	K					
Actuator color Yellow (standard actuator)	4					Number(s) of actuators from 1 to 16 OR Number of pairs from 1G2 to 8G2
Actuator color White 3-positions (center-off)	9					



## Dual Port D-Sub Connectors

**RoHS  
Compliant**

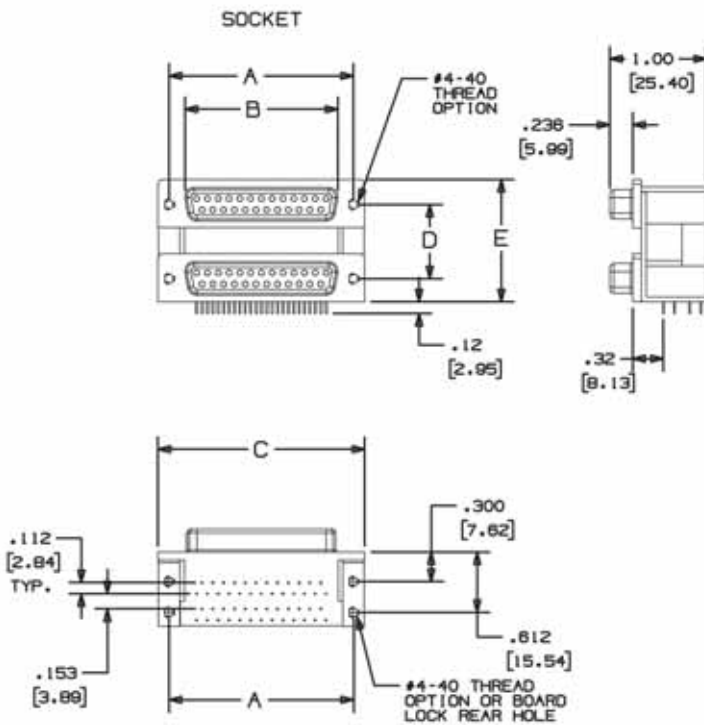

NO. OF CKTS	DIMENSIONS			PORT CENTERS	TOTAL HEIGHT
	A	B	C		
9	.984 (24.99)	.843 (21.33)	1.213 (30.81)	.625 (15.88)	1.119 (28.42)
15	1.312 (33.32)	.971 (24.66)	1.541 (39.14)	.750 (19.05)	1.244 (31.60)
25	1.852 (47.04)	1.511 (38.38)	2.088 (53.04)	.900 (22.86)	1.394 (35.41)
37	2.500 (63.50)	2.729 (69.32)	2.182 (55.42)		

### ORDERING INFORMATION

<p><b>Series</b> Dual Port D-Sub</p> <hr/> <p><b>Top Port</b> Pos Plugs – 9P, 15P, 25P, 37P Pos Socket – 9S, 15S, 25S, 37S</p> <hr/> <p><b>Bottom Port</b> Pos Plugs – 9P, 15P, 25P, 37P Pos Socket – 9S, 15S, 25S, 37S</p> <hr/>	<p><b>RDD XXX YYY N Z AA</b></p>	<p><b>Options</b> J1 – Jack Screws Installed R – Rear Boardlocks only OB – Open Back</p> <hr/> <p><b>Mounting</b> A – Thru Hole B – #4-40 Threaded Holes</p> <hr/> <p><b>Port Spacing</b> 1 – 0.625" 2 – 0.750" 3 – 0.900"</p> <hr/>
---	----------------------------------	--

## .100" Stacked Headers

RoHS  
Compliant

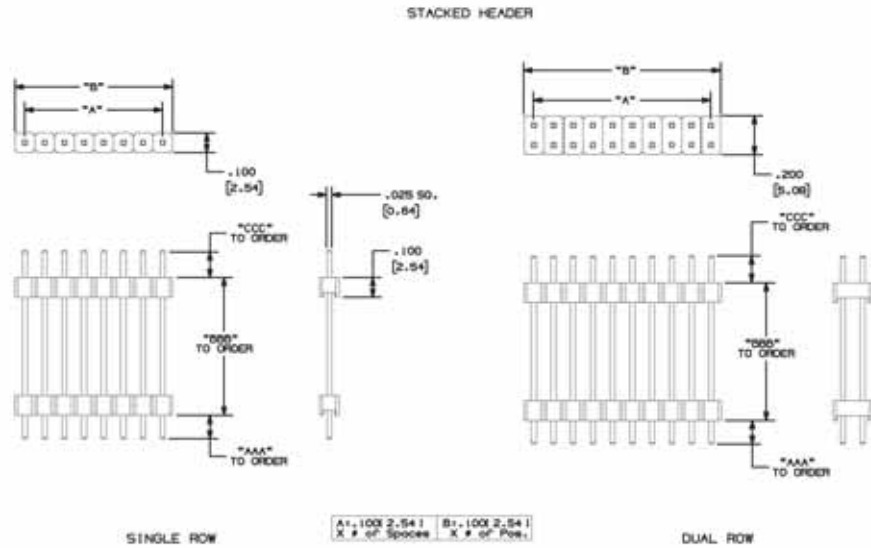
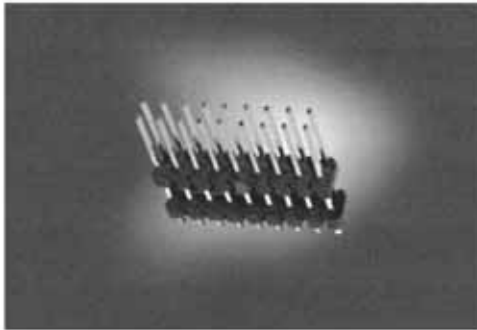

\*Contact Factory for surface mount information.

### ORDERING INFORMATION

	SH	X	YY	N	AAA	BBB	CCC	
<b>Stacked HDR</b>	SH – Single Row							C – Post length above insulator (inches)
	SP – Dual Row							
	SM – Surface Mount							B – Distance between insulators (inches)
<b>No. of Rows</b>	1 – Single Row							A – PC Tail length (inches)
	2 – Dual Row							
<b>No. of Positions</b>	Single Row (2-40)							<b>Plating Codes</b>
	Dual Row (4-80)							G – Full Gold
								S – Gold in mating area, Tin on PC tails
								T – Full Tin plating

## .100" Socket Strips

RoHS  
Compliant

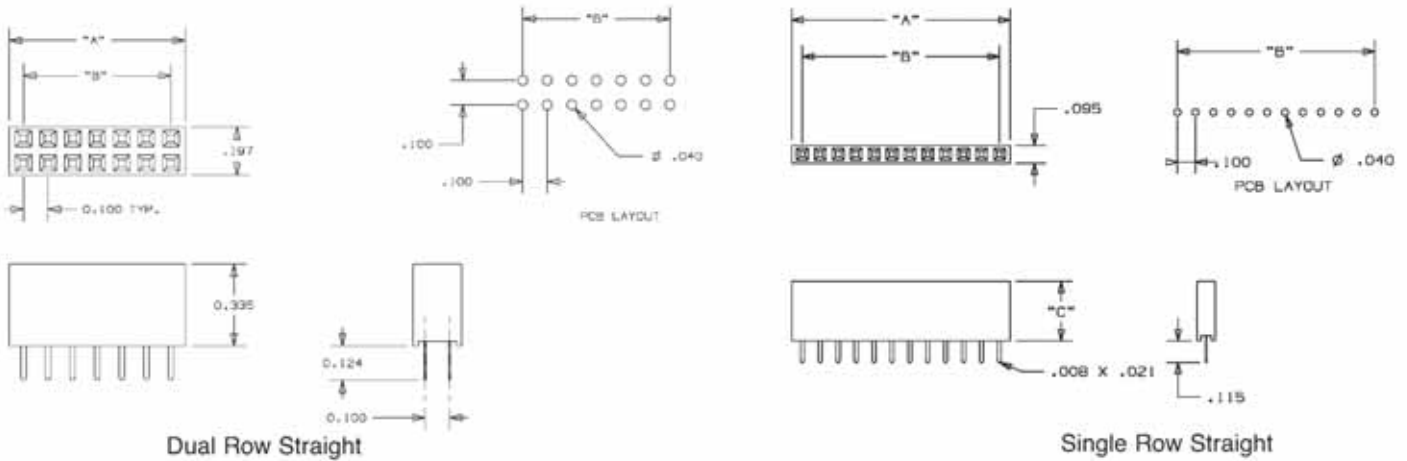
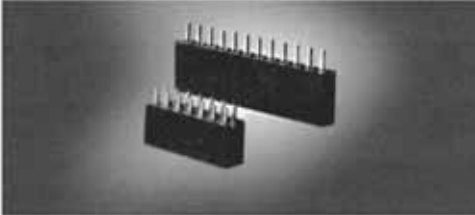

\*Contact Factory for surface mount information.

### ORDERING INFORMATION

Series	050	SXX	A	NN	SN	YYY	Options
Style							SMT – Surface Mount
Housing Type							Plating Codes
A- .335 Profile							S0 – Gold in mating area, Tin on tails
B- .197 Profile (Contact factory for availability)							S3 –10 $\mu$ " Gold in mating area, Tin on tails
							S4 –15" Gold in mating area, Tin on tails
							SN – Full tin Plating
							No. of Positions
							Single Row 02–40
							Dual Row 04–80

## 2.0 mm IDC Socket Female Connectors

**RoHS  
Compliant**

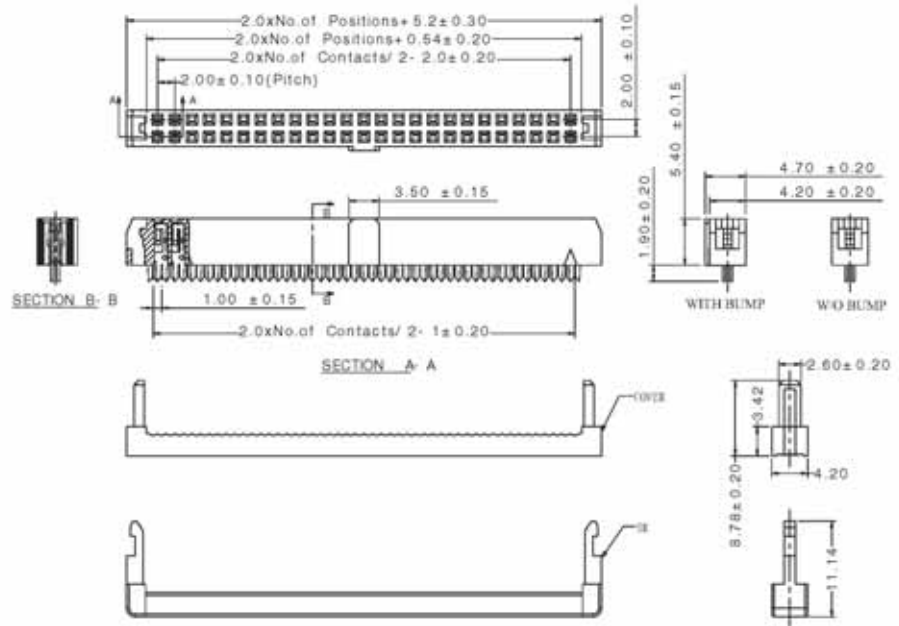

### ORDERING INFORMATION

**052 - 0XX - 4 XX 5 A**

Series

No. of Circuits

10, 14, 16, 20, 24, 26, 30, 34, 40, 44, 50, 60

Female

A – Coding Key

Blank – No Key

IDC

Plating

S0 – Selective Gold Flash

S3 – Selective  $10\mu$ " Gold

S4 – Selective  $15\mu$ " Gold



## 2.0 mm Male Box Header

**RoHS  
Compliant**

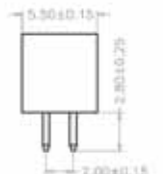
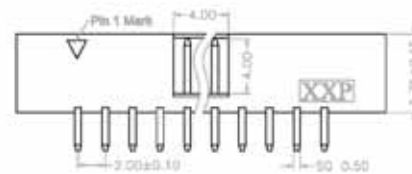
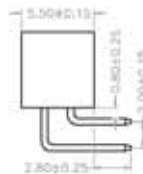
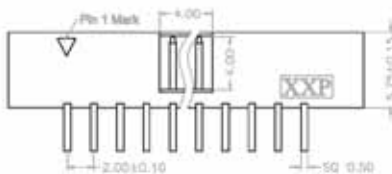
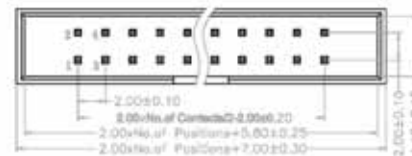
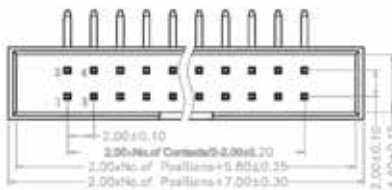
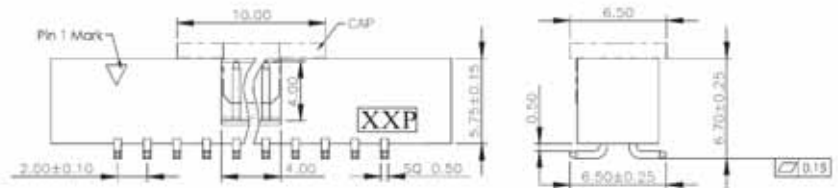
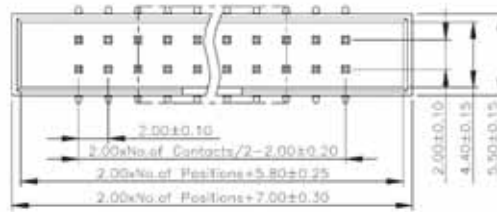

\*Contact Factory for surface mount information.

### ORDERING INFORMATION

**059 - 0XX - 0 XX 3**

**Series**

**No. of Circuits**

10, 14, 16, 20, 24, 26, 30, 34, 40, 44, 50, 60

**Tail Type**

0 – Right Angle

1 – Straight

**Pin Configuration**

3 – Thru Hole Solder

SMT – Surface Mount

**Plating**

S0 – Selective Gold Flash

S3 – Selective 10µ" Gold

S4 – Selective 15µ" Gold

## 2.0mm Female Socket Strips

**RoHS  
Compliant**

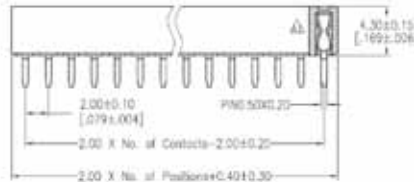
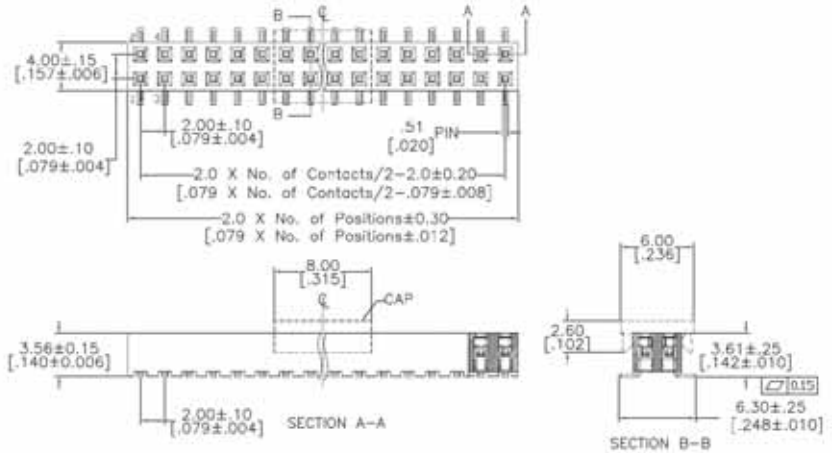
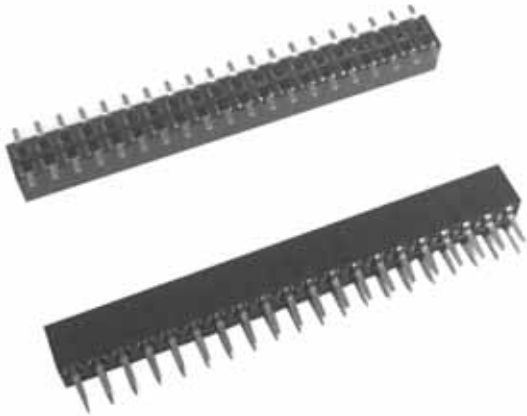

### ORDERING INFORMATION

Series	052	S2	A	XX	XX	YYY	Options
Dual Row							SMT – Surface Mount
No. of Circuits							Plating
10, 14, 16, 20, 24, 26, 30, 34, 40, 44, 50, 60							SN - Full Tin
							S0 – Selective Gold Flash
							S3 – Selective $10\mu''$ Gold
							S4 – Selective $15\mu''$ Gold

## 2.00mm PIN Headers

RoHS  
Compliant

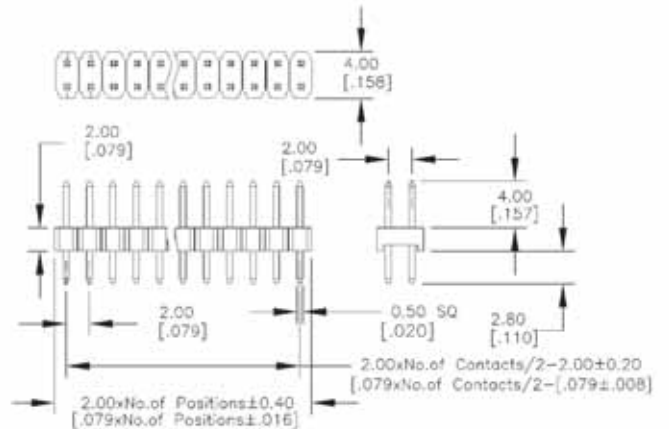
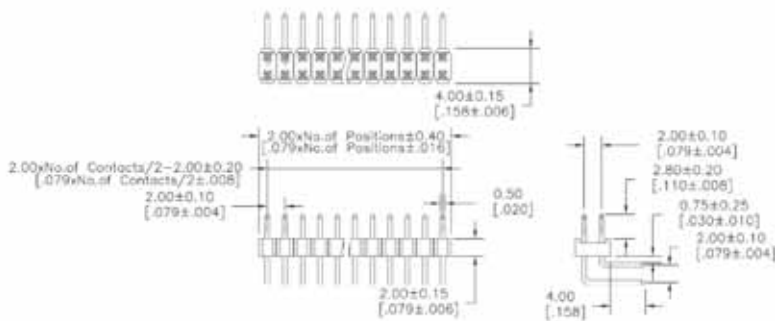
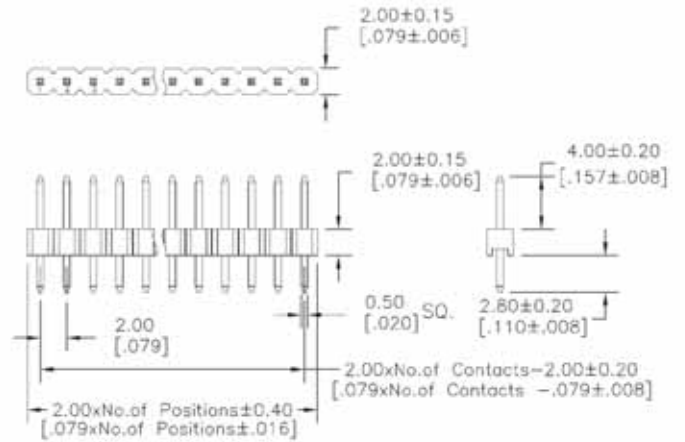
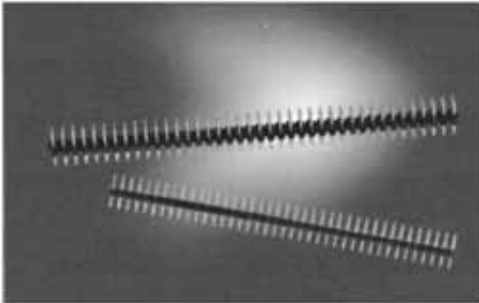

### ORDERING INFORMATION – 2.00 mm Pin Headers

**052 X 0XX - 1 SN X XX**

**Series**

**Profile Type**

S – Single Row  
D – Dual Row

**No. of Positions**

Single Row (1-40)  
Dual Row (2-80)

**Options**

02 – Guide Pins  
RP – Reeled Pick and Place Cap  
TP – Tubes Pick and Place Cap

**Pin Configuration**

3 – Thru Hole Solder  
M – Surface Mount

**Plating**

S0 – Selective Gold Flash  
S3 – Selective 10µ" Gold  
S4 – Selective 15µ" Gold  
SN - Full Tin

**Pin Type**

1 – Straight  
0 – Right Angle

## 1.0mm Female Socket Strips

**RoHS  
Compliant**

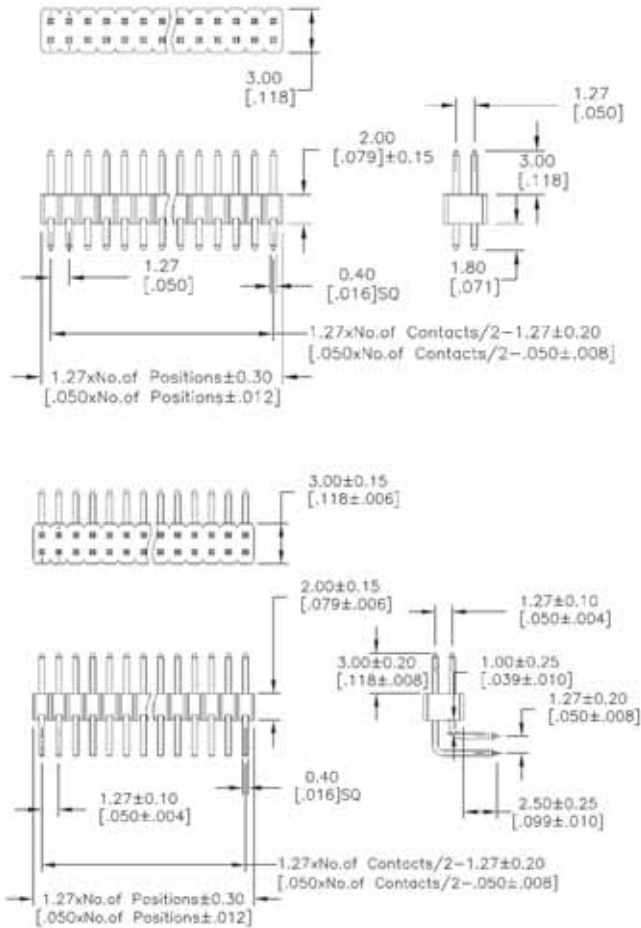
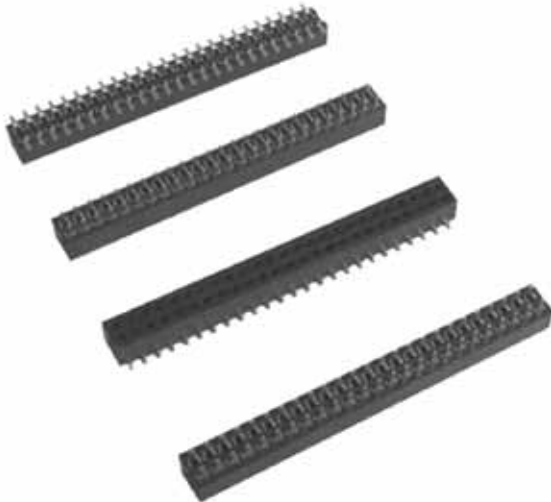

### ORDERING INFORMATION

<b>Series</b>	<b>054 S2 A XXX XX X - X</b>	<b>Options</b> Blank - Tubes Std C-Tubes with Cap R-Tape & Reel k + Cap
<b>No. of Circuits</b>	04-100	<b>Options</b> M - Surface Mount
		<b>Plating</b> SN - Full Tin Plating S0 - Selective Gold Flash S3 - Selective 10µ" Gold S4 - Selective 15µ" Gold



## 1.00mm PIN Headers

**RoHS  
Compliant**

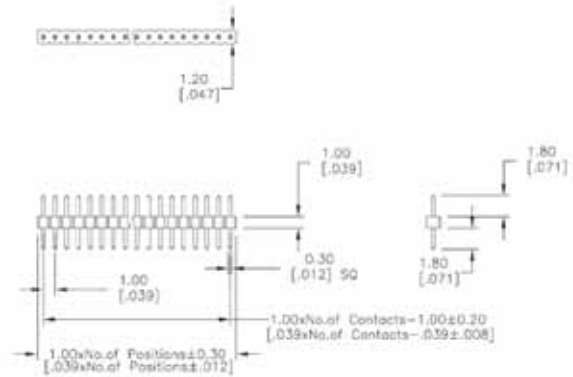
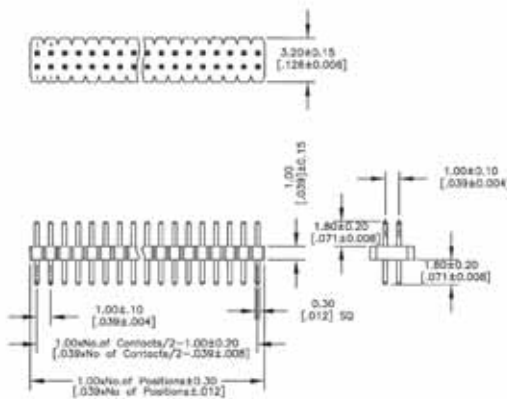
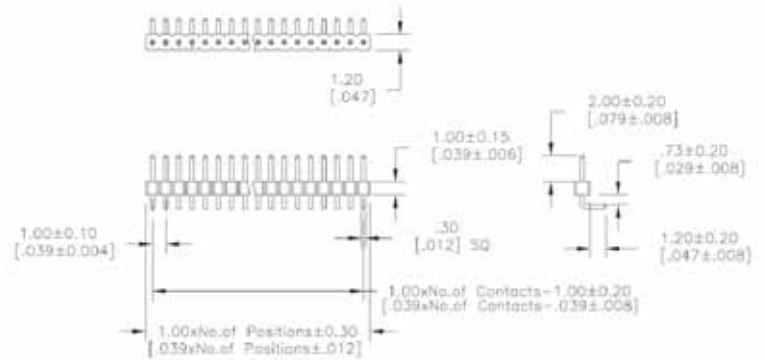
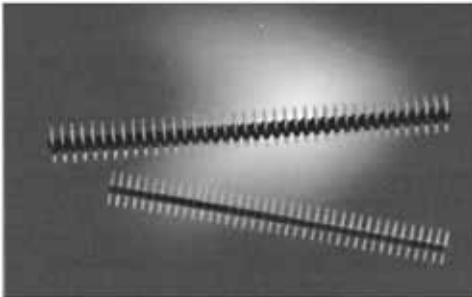

### ORDERING INFORMATION – 1.00 mm Pin Headers

054 X 0XX - 1 SN X XX						
<b>Series</b>						<b>Options</b> 02 – Guide Pins RP – Reeled Pick and Place Cap TP – Tubes Pick and Place Cap
<b>Profile Type</b> S – Single Row D – Dual Row						<b>Pin Configuration</b> 3 – Thru Hole Solder M – Surface Mount
<b>No. of Positions</b> Single Row (2-50) Dual Row (4-100)						<b>Plating</b> S0 – Selective Gold Flash S3 – Selective 10µ" Gold S4 – Selective 15µ" Gold SN - Full Tin
						<b>Pin Type</b> 1 – Straight 0 – Right Angle

## .050" X .050" Female IDC Sockets

RoHS  
Compliant

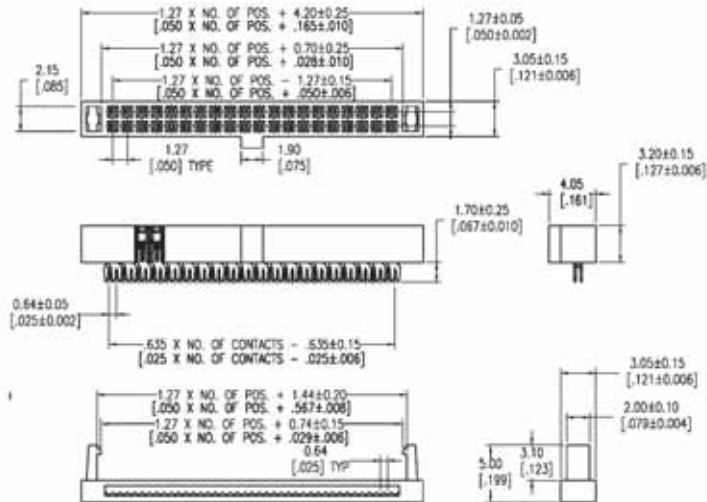

### ORDERING INFORMATION

**025 - 0XX - 4 XX 5 A**

Series

No. of Circuits

6, 10, 14, 16, 20, 24, 26, 30, 34,  
40, 44, 50, 60

Options

A – Center Bump  
Blank – No Bump

Plating

SN - Full Tin Plating  
S0 – Selective Gold Flash  
S3 – Selective 10 $\mu$ " Gold  
S4 – Selective 15 $\mu$ " Gold

**RoHS  
Compliant**

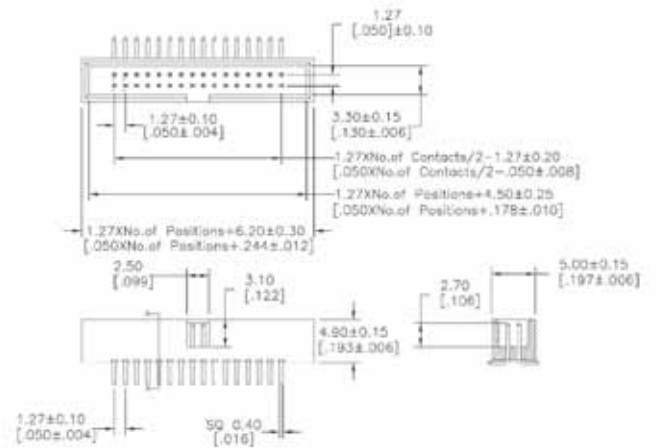
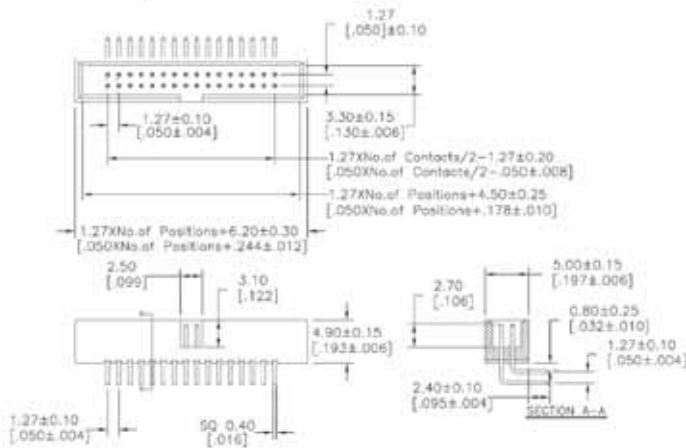
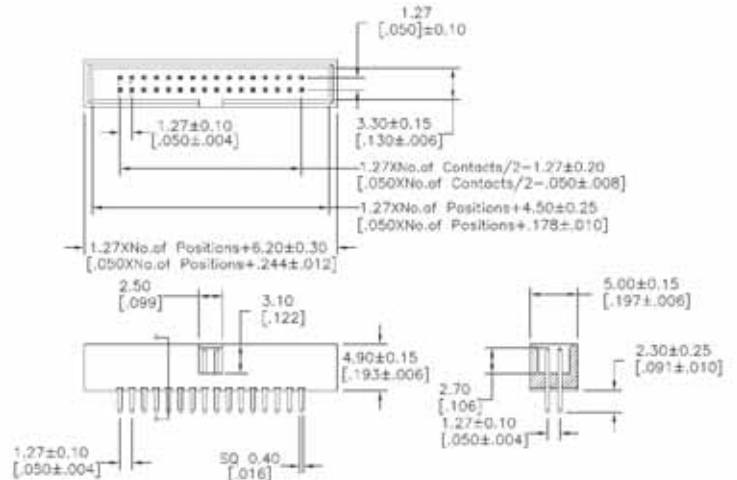

## ORDERING INFORMATION

**025 - 0XX - 1 XX 3**

**Series**

**No. of Circuits**

6, 10, 14, 16, 20, 24, 26, 30, 34,  
40, 44, 50, 60

**Tail Type**

3 – Thru Hole Solder  
M – Surface Mount

**Plating**

SN – Full Tin Plating  
S0 – Selective Gold Flash  
S3 – Selective 10μ" Gold  
S4 – Selective 15μ" Gold

**Tail Configuration**

0 – Right Angle  
1 – Straight

# New Products

## .050" X .050" Male Pin Headers



RoHS  
Compliant



025-0XX-0XX3	119
025-0XX-1XX3	119
025-0XX-1XXM	119
025-0XX-4XX5	118
025-0XX-4XX5A	118

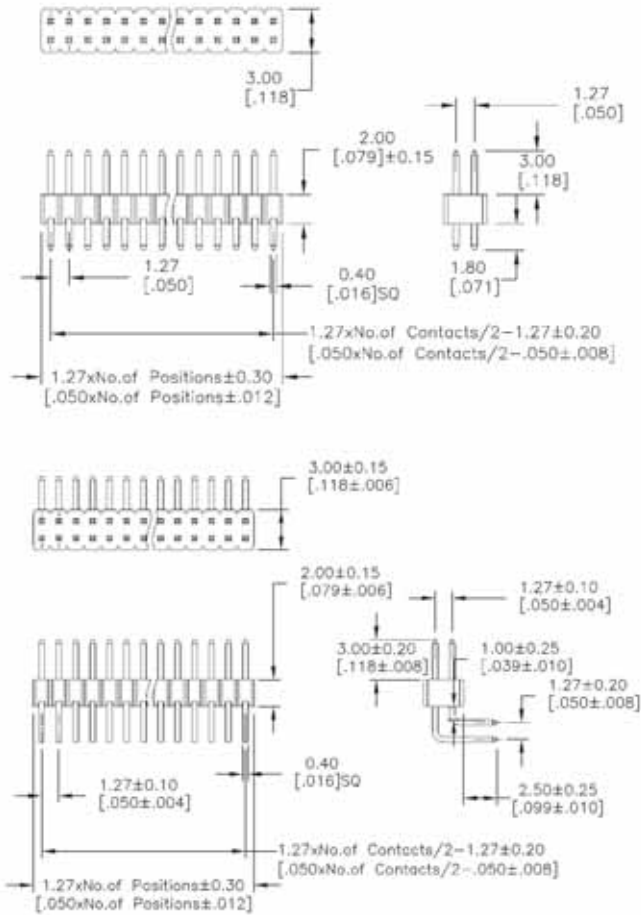

### ORDERING INFORMATION

\*Contact Factory for surface mount information.

**026 - 0XX - 1 XX 3**

Series

No. of Circuits

6, 10, 14, 16, 20, 24, 26, 30, 34, 40, 44, 50, 60

Tail Type

3 – Thru Hole Solder  
M – Surface Mount

Plating

SN - Full Tin Plating  
S0 – Selective Gold Flash  
S3 – Selective  $10\mu$ " Gold  
S4 – Selective  $15\mu$ " Gold

Tail Configuration

0 – Right Angle  
1 – Straight



PART NUMBER	PAGE	PART NUMBER	PAGE	PART NUMBER	PAGE
<b>025 SERIES</b>					
025-0XX-0XX3	119	050-0XX-133B	34,35	050S2AXXS0SMT	111
025-0XX-1XX3	119	050-0XX-152	34,35	050S2AXXS3	111
025-0XX-1XXM	119	050-0XX-152A	34,35	050S2AXXS3SMT	111
025-0XX-4XX5	118	050-0XX-152B	34,35	050S2AXXS4	111
025-0XX-4XX5A	118	050-0XX-153	34,35	050S2AXXS4SMT	111
<b>026 SERIES</b>					
026-0XX-0XX3	120	050-0XX-153A	34,35	050S2AXXSN	111
026-0XX-1XX3	120	050-0XX-153B	34,35	050S2AXXSN SMT	111
026-0XX-1XXM	120	050-0XX-415	33	050S2BXXS0	111
<b>033 SERIES</b>					
033F30V96CR	98	050-0XX-415A	33	050S2BXXS0SMT	111
<b>050 SERIES</b>					
050-000-022	39	050-0XX-415AR	33	050S2BXXS3	111
050-000-044	39	050-0XX-435	33	050S2BXXS3SMT	111
050-000-062	39	050-0XX-435A	33	050S2BXXS4	111
050-000-063	39	050-0XX-435AR	33	050S2BXXS4SMT	111
050-000-077	39	050-0XX-455	33	050S2BXXSN	111
050-000-0XX	33	050-0XX-455A	33	050S2BXXSN SMT	111
050-0XX-012	34,35	050-0XX-455AR	33	050S2BXXSN SMT	111
050-0XX-012A	34,35	050F28VXXCR	42	050S2RAXXS0	111
050-0XX-012B	34,35	050S1AXXS0	111	050S2RAXXS0SMT	111
050-0XX-013	34,35	050S1AXXS0SMT	111	050S2RAXXS3	111
050-0XX-013A	34,35	050S1AXXS3	111	050S2RAXXS3SMT	111
050-0XX-013B	34,35	050S1AXXS3SMT	111	050S2RAXXS4	111
050-0XX-032	34,35	050S1AXXS4	111	050S2RAXXS4SMT	111
050-0XX-032A	34,35	050S1AXXS4SMT	111	050S2RAXXSN	111
050-0XX-032B	34,35	050S1AXXSN	111	050S2RAXXSN SMT	111
050-0XX-033	34,35	050S1AXXSN SMT	111	050S2RBXXS0	111
050-0XX-033A	34,35	050S1BXXS0	111	050S2RBXXS0SMT	111
050-0XX-033B	34,35	050S1BXXS0SMT	111	050S2RBXXS3	111
050-0XX-052	34,35	050S1BXXS3	111	050S2RBXXS3SMT	111
050-0XX-052A	34,35	050S1BXXS3SMT	111	050S2RBXXS4	111
050-0XX-052B	34,35	050S1BXXS4	111	050S2RBXXS4SMT	111
050-0XX-053	34,35	050S1BXXS4SMT	111	050S2RBXXSN	111
050-0XX-053A	34,35	050S1BXXSN	111	<b>051 SERIES</b>	
050-0XX-053B	34,35	050S1BXXSN SMT	111	051-0XX-0X3	41
050-0XX-112	34,35	050S1RAXXS0	111	051-0XX-1X3	41
050-0XX-112A	34,35	050S1RAXXS0SMT	111	051-000-411	41
050-0XX-112B	34,35	050S1RAXXS3	111	051-000-451	41
050-0XX-113	34,35	050S1RAXXS3SMT	111	<b>052 SERIES</b>	
050-0XX-113A	34,35	050S1RAXXS4	111	052-0XX-4S05	112
050-0XX-113B	34,35	050S1RAXXS4SMT	111	052-0XX-4S05A	112
050-0XX-132	34,35	050S1RAXXSN	111	052-0XX-4S35	112
050-0XX-132A	34,35	050S1RAXXSN SMT	111	052-0XX-4S35A	112
050-0XX-132B	34,35	050S1RBXXS0	111	052-0XX-4S45	112
050-0XX-133	34,35	050S1RBXXS0SMT	111	052-0XX-4S45A	112
050-0XX-133A	34,35	050S1RBXXS3	111	052D0XX-1S03	115
		050S1RBXXS3SMT	111	052D0XX-1S03XX	115
		050S1RBXXS4	111	052D0XX-1S0M	115
		050S1RBXXS4SMT	111	052D0XX-1S0MXX	115
		050S1RBXXSN	111	052D0XX-1S33	115
		050S1RBXXSN SMT	111		
		050S2AXXS0	111		



PART NUMBER	PAGE	PART NUMBER	PAGE	PART NUMBER	PAGE
052D0XX-1S33XX	115	054D0XX-1S0M	117	056-0XX-393/K	38
052D0XX-1S3M	115	054D0XX-1S0MXX	117	<b>057 SERIES</b>	
052D0XX-1S3MXX	115	054D0XX-1S33	117	057-000-065	40
052D0XX-1S43	115	054D0XX-1S3M	117	057-000-075	40
052D0XX-1S43XX	115	054D0XX-1S3MXX	117	057-000-0XX	37
052D0XX-1S4M	115	054D0XX-1S43	117	057-000-100	40
052D0XX-1S4MXX	115	054D0XX-1S4M	117	057-0XX-032	36
052D0XX-1SN3	115	054D0XX-1S4MXX	117	057-0XX-033	36
052D0XX-1SN3XX	115	054D0XX-1SN3	117	057-0XX-052	36
052D0XX-1SNM	115	054D0XX-1SNM	117	057-0XX-053	36
052D0XX-1SNMXX	115	054D0XX-1SNMXX	117	057-0XX-132	36
052S0XX-1S03	115	054S0XX-0S03	117	057-0XX-133	36
052S0XX-1S03XX	115	054S0XX-0S0M	117	057-0XX-135APB	37
052S0XX-1S0M	115	054S0XX-0S0MXX	117	057-0XX-135BPB	37
052S0XX-1S0MXX	115	054S0XX-0S33	117	057-0XX-135PB	37
052S0XX-1S33	115	054S0XX-0S3M	117	057-0XX-135SAPB	37
052S0XX-1S33XX	115	054S0XX-0S3MXX	117	057-0XX-135SBPB	37
052S0XX-1S3M	115	054S0XX-0S43	117	057-0XX-135SPB	37
052S0XX-1S3MXX	115	054S0XX-0S4M	117	057-0XX-152	36
052S0XX-1S43	115	054S0XX-0S4MXX	117	057-0XX-153	36
052S0XX-1S43XX	115	054S0XX-0SN3	117	057-0XX-155APB	37
052S0XX-1S4M	115	054S0XX-0SNM	117	057-0XX-155BPB	37
052S0XX-1S4MXX	115	054S0XX-0SNMXX	117	057-0XX-155PB	37
052S0XX-1SN3	115	054S0XX-1S03	117	057-0XX-155SAPB	37
052S0XX-1SN3XX	115	054S0XX-1S0M	117	057-0XX-155SBPB	37
052S0XX-1SNM	115	054S0XX-1S0MXX	117	057-0XX-155SPB	37
052S0XX-1SNMXX	115	054S0XX-1S33	117	<b>059 SERIES</b>	
052S2AXXS0	114	054S0XX-1S3M	117	059-0XX-0S03	113
052S2AXXS0SMT	114	054S0XX-1S3MXX	117	059-0XX-0S33	113
052S2AXXS3	114	054S0XX-1S43	117	059-0XX-0S43	113
052S2AXXS3SMT	114	054S0XX-1S4M	117	059-0XX-1S03	113
052S2AXXS4	114	054S0XX-1S4MXX	117	059-0XX-1S33	113
052S2AXXS4SMT	114	054S0XX-1SN3	117	059-0XX-1S43	113
052S2AXXS4SMT	114	054S0XX-1SNM	117	059-0XX-0S0SMT	113
052S2AXXS4SMT	114	054S0XX-1SNMXX	117	059-0XX-0S3SMT	113
052S2AXXS4SMT	114	054S2AXXS0	116	059-0XX-0S4SMT	113
052S2AXXS4SMT	114	054S2AXXS0M	116	059-0XX-1S0SMT	113
052S2AXXS4SMT	114	054S2AXXS0M-X	116	059-0XX-1S3SMT	113
052S2AXXS4SMT	114	054S2AXXS3	116	059-0XX-1S4SMT	113
052S2AXXS4SMT	114	054S2AXXS3M	116	<b>100 SERIES</b>	
052S2AXXS4SMT	114	054S2AXXS3M-X	116	100-000-002	84
052S2AXXS4SMT	114	054S2AXXS4	116	100-000-008	84
052S2AXXS4SMT	114	054S2AXXS4-X	116	100-000-026	85
052S2AXXS4SMT	114	054S2AXXS4SMT	116	100-000-043	39,85
052S2AXXS4SMT	114	054S2AXXS4SMT	116	100-000-064	88
052S2AXXS4SMT	114	054S2AXXS4SMT	116	100-000-065	89
052S2AXXS4SMT	114	054S2AXXS4SMT	116	100-000-066	89
052S2AXXS4SMT	114	054S2AXXS4SMT	116	100-000-067	89
054D0XX-0S03	117	054S2AXXS4SMT	116		
054D0XX-0S0M	117	054S2AXXS4SMT	116		
054D0XX-0S0MXX	117	054S2AXXS4SMT	116		
054D0XX-0S33	117	054S2AXXS4SMT	116		
054D0XX-0S3M	117	054S2AXXS4SMT	116		
054D0XX-0S3MXX	117	054S2AXXS4SMT	116		
054D0XX-0S43	117	054S2AXXS4SMT	116		
054D0XX-0S4M	117	054S2AXXS4SMT	116		
054D0XX-0S4MXX	117	054S2AXXS4SMT	116		
054D0XX-0SN3	117	054S2AXXS4SMT	116		
054D0XX-0SNM	117	054S2AXXS4SMT	116		
054D0XX-0SNMXX	117	054S2AXXS4SMT	116		
054D0XX-1S03	117	054S2AXXS4SMT	116		
		<b>056 SERIES</b>			
		056-0XX-392/K	38		



PART NUMBER	PAGE	PART NUMBER	PAGE	PART NUMBER	PAGE
100-000-071	.88	100F24VXXNXXCR	.25	156F22VXXDR	.25
100-000-072	.88	100F24VXXNXXDR	.25	156F18VXXNXXCR	.25
100-030-033	.59	100F26VXXCR	.25	156F18VXXNXXDR	.25
100-030-432	.60	100F26VXXDR	.25	156F20VXXNXXCR	.25
100-032-033	.69	100F26VXXNXXCR	.25	156F20VXXNXXDR	.25
100-032-432	.70	100F26VXXNXXDR	.25	156F22VXXNXXCR	.25
100-032-438	.70			156F22VXXNXXDR	.25
100-048-033	.71	<b>101 SERIES</b>			
100-048-133	.71	101-048-033	.73	<b>C</b>	
100-048-438	.72	101-048-438-LP	.74	CACSF-SS	.104
100-064-0XX	.63			CE100F22-XX-C	.7
100-064-1XX	.63	<b>106 SERIES</b>		CE100F22-XX-D	.7
100-064-4XX	.64	106-128-033	.75	CE100F22-XX-R	.7,24
100-064-533	.64	106-128-432	.76	CE100F24-XX-C	.7
100-096-0XX	.65	106-128-433	.76	CE100F24-XX-D	.7
100-096-1XX	.65			CE100F24-XX-R	.7,24
100-096-4XX	.66	<b>120 SERIES</b>		CE100F26-XX-C	.7
100-096-533	.66	120-332-033A	.91	CE100F26-XX-D	.7
100-096-9XX	.67	120-332-435	.92	CE100F26-XX-R	.7,24
100-332-033	.61	120-332-435F	.92	CE100F28-XX-C	.7
100-332-133	.61	120-064-033A	.93	CE100F28-XX-D	.7
100-332-4XX	.62	120-064-133A	.93	CE100F28-XX-R	.7,24
100-332-533	.62	120-064-435	.94	CE156F18-XX-C	.12
100-348-0XX	.61	120-064-435F	.94	CE156F18-XX-D	.12
100-348-1XX	.61	120-964-033A	.95	CE156F20-XX-C	.12
100-348-4XX	.62	120-964-133A	.95	CE156F20-XX-D	.12
100-348-533	.62	120-964-435	.96	CE156F22-XX-C	.12
100-532-032	.63	120-964-435F	.96	CE156F22-XX-D	.12
100-532-432	.64	120-096-435	.96	CE156F28-XX-C	.12
100-632-0XX	.57	120-096-435F	.96	CE156F28-XX-D	.12
100-632-1XX	.57	120-000-032	.97	CEH156F18-XX-C	.14
100-632-4XX	.58	120-000-042	.97	CEH156F18-XX-D	.14
100-632-5XX	.58			CEP100F22-XX-C	.10
100-632-6XX	.58	<b>130 SERIES</b>		CEP100F22-XX-D	.10
100-932-0XX	.65	130-064-533	.78	CEP100F22-XX-R	.10,24
100-932-1XX	.65	130-064-133	.77	CEP100F24-XX-C	.10
100-932-4XX	.66	130-064-332	.77	CEP100F24-XX-D	.10
100-932-533	.66	130-348-133	.79	CEP100F24-XX-R	.10,24
100-932-533	.66	130-348-533	.80	CEP100F26-XX-C	.10
100-932-633	.66	130-348-553	.80	CEP100F26-XX-D	.10
100-964-0XX	.65	130-964-1X3	.81	CEP100F26-XX-R	.10,24
100-964-1XX	.65	130-096-1X3	.81	CEP100F28-XX-C	.10
100-964-4XX	.66	130-964-533	.82	CEP100F28-XX-D	.10
100-964-533	.66	130-096-533	.82	CEP100F28-XX-R	.10,24
100-964-9XX	.67			CEP156F18-XX-C	.13
100F22VXXCR	.25	<b>156 SERIES</b>		CEP156F18-XX-D	.13
100F22VXXDR	.25	156F18VXXCR	.25	CEP156F20-XX-C	.13
100F22VXXNXXCR	.25	156F18VXXDR	.25	CEP156F20-XX-D	.13
100F22VXXNXXDR	.25	156F20VXXCR	.25	CEP156F22-XX-C	.13
100F24VXXCR	.25	156F20VXXDR	.25	CEP156F22-XX-D	.13
100F24VXXDR	.25	156F22VXXCR	.25	CEP156F28-XX-C	.13



PART NUMBER	PAGE	PART NUMBER	PAGE	PART NUMBER	PAGE
CEP156F28-XX-D	13	CTP100F28-XX-C	10	<b>L</b>	
CPD64F50FM	43	CTP100F28-XX-D	10	LCTM64F50FRT	44
CPD64F50FRI	43	CTP100F28-XX-R	10,24	<b>M</b>	
CPD64F50HM	43	CTP156F18-XX-C	13	MCP5	43
CPD64F52PM	43	CTP156F18-XX-D	13	MCT	20
CRSW18722SD	106	CTP156F20-XX-C	13	MFAS100-XX-C	9
CRSW18722SD-L	106	CTP156F20-XX-D	13	MFAS100-XX-D	9
CRSW22SD	103	CTP156F22-XX-C	13	MFAS156-XX-C	15
CRSW25022SD	106	CTP156F22-XX-D	13	MFAS156-XX-D	15
CRSW25022SD-L	106	CTP156F28-XX-C	13	MFSS100-XX-C	9
CSC-XX	100	CTP156F28-XX-D	13	MFSS100-XX-D	9
CSF-187-E3	107	<b>D</b>		MFSS156-XX-C	15
CSF-187-E6	107	DA001	45,47	MFSS156-XX-D	15
CSF-MH-XX-02	105	DA009	45	MLAS100-XX-C	9
CSF-XX03-01	100	DA015	45	MLAS100-XX-D	9
CSF-XX03-02	100	DA025	45	MLAS156-XX-C	15
CT100F22-XX-C	7	DA037	45	MLAS156-XX-D	15
CT100F22-XX-D	7	<b>E</b>		MLSS100-XX-C	9
CT100F22-XX-R	7,24	EC100F-XX-C	7	MLSS100-XX-D	9
CT100F24-XX-C	7	EC100F-XX-D	7	MLSS156-XX-C	15
CT100F24-XX-D	7	EC156F-XX-C	10	MLSS156-XX-D	15
CT100F24-XX-R	7,24	EC156F-XX-D	10	MMIT-100F	20
CT100F26-XX-C	7	ECT	22	MMIT-156F	20
CT100F26-XX-D	7	ECT-100F	22	MPAS100-XX-C	9
CT100F26-XX-R	7,24	ECT-156F	22	MPAS100-XX-D	9
CT100F28-XX-C	7	<b>F</b>		MPAS156-XX-C	15
CT100F28-XX-D	7	FB100-XX-XXXXYY	16,17	MPAS156-XX-D	15
CT100F28-XX-R	7,24	FB100AXX-XXXXYY	16,17	MPSS100-XX-C	9
CT156F18-XX-C	12	FT100-XX-XXXXYY	16,17	MPSS100-XX-D	9
CT156F18-XX-D	12	FT100AXX-XXXXYY	16,17	MPSS156-XX-C	15
CT156F20-XX-C	12	<b>I</b>		MPSS156-XX-D	15
CT156F20-XX-D	12	IDMXXPH5	45	MRT-100F	20
CT156F22-XX-C	12	IDMXXPT5	45	MRT-156F	20
CT156F22-XX-D	12	IDMXXSH5	45	MTAS100-XX-C	11
CT156F22-XX-R	12	IDMXXST5	45	MTAS100-XX-D	11
CT156F28-XX-C	12	IRMXXPL5	46	MTAS156-XX-C	15
CT156F28-XX-D	12	IRMXXSG5	46	MTAS156-XX-D	15
CTD-100F	21	IRMXXSK5	46	MTSS100-XX-C	11
CTD-156F	21	<b>J</b>		MTSS100-XX-D	11
CTH156F18-XX-C	14	JSA4XXG0	108	MTSS156-XX-C	15
CTH156F18-XX-D	14	JSA9XXG0	108	MTSS156-XX-D	15
CTM64F50FM	43	JSC4XXG0	108	MWWS100-XX-C	19
CTP100F22-XX-C	10	JSC9XXG0	108	MWWS100-XX-D	19
CTP100F22-XX-D	10	JSK9XXG0	108	MWWS156-XX-C	19
CTP100F22-XX-R	10,24			MWWS156-XX-D	19
CTP100F24-XX-C	10			<b>P</b>	
CTP100F24-XX-D	10			PCT	21
CTP100F24-XX-R	10,24			PCTBM	21
CTP100F26-XX-C	10				
CTP100F26-XX-D	10				
CTP100F26-XX-R	10,24				



PART NUMBER	PAGE	PART NUMBER	PAGE	PART NUMBER	PAGE
PPHT-100F	.23				
PPHT-100FC	.23				
PPHT-100FE	.23				
PPHT-100FT	.23				
PPHT-156F	.23				
PPHT-156FC	.23				
PPHT-156FE	.23				
PPHT-156FT	.23				
PPHT-CSF3	.101				
PPHT-CSF-C	.101				
PPHT-CSF-E	.101				
PPT-632	.102				
PPT-632-6-G	.102				
PPT-632-G	.102				
PPT-832	.102				
PPT-M4	.102				
PPT-M4-6	.102				
PPT-M4-6-G	.102				
<b>R</b>					
RDDXXXYYY	.109				
RDMXXPA5	.47				
RDMXXPB5	.47				
RDMXXSA5	.47				
RDMXXSB5	.47				
RRMXXSE5	.48				
RRMXXSF5	.48				
<b>S</b>					
SCC100F-XX-C	.7,10				
SCC100F-XX-D	.7,10				
SCC156F-XX-C	.12,13,14				
SCC156F-XX-D	.12,13,14				
SH1**G*** ** *	.110				
SH1**S*** ** *	.110				
SH1**T*** ** *	.110				
SH2**G*** ** *	.110				
SH2**S*** ** *	.110				
SH2**T*** ** *	.110				
<b>T</b>					
TC100F-XX-C	.7,10				
TC100F-XX-D	.7,10				
TC156F-XX-C	.12,13,14				
TC156F-XX-D	.12,13,14				

