

SiC Power MOSFET

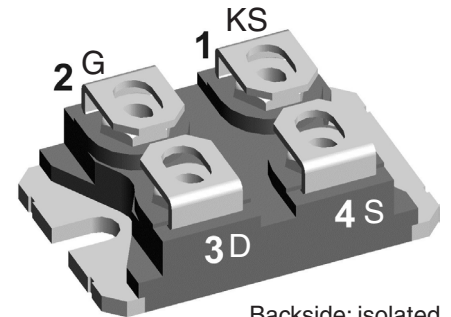
$$I_{D25} = 90 \text{ A}$$

$$V_{DSS} = 1700 \text{ V}$$

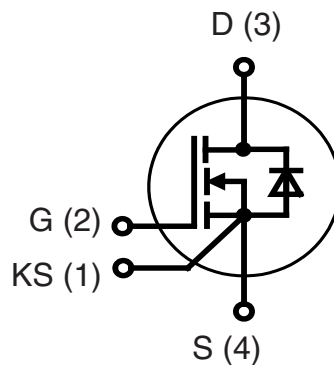
$$R_{DS(on) \text{ max}} = 35 \text{ m}\Omega$$

Kelvin Source gate connection

Part number
IXFN90N170SK



Backside: isolated
 E72873



Features / Advantages:

- High speed switching with low capacitances
- High blocking voltage with low $R_{DS(on)}$
- Easy to parallel and simple to drive
- Resistant to latch-up
- Real Kelvin source connection

Applications:

- Solar inverters
- High voltage DC/DC converters
- Motor drives
- Switch mode power supplies
- UPS
- Battery chargers
- Induction heating

Package: SOT-227B (minibloc)

- Isolation Voltage: 2500 V~
- Industry standard outline
- RoHS compliant
- Epoxy meets UL 94V-0
- Base plate with Aluminium nitride isolation
- Advanced power cycling

Disclaimer Notice

Information furnished is believed to be accurate and reliable. However, users should independently evaluate the suitability of and test each product selected for their own applications. Littelfuse products are not designed for, and may not be used in, all applications. Read complete Disclaimer Notice Disclaimer Notice at www.littelfuse.com/disclaimer-electronics.

MOSFET				Ratings			
Symbol	Definitions	Conditions	min.	typ.	max.		
$V_{(BR)DSS}$	drain source breakdown voltage	$I_D = 200 \mu A$ $T_{VJ} = 25^\circ C$	1700			V	
$V_{GS(max)}$	max transient gate source voltage		-10		+25	V	
V_{GS}	continous gate source voltage	recommended operational value	-5		+20	V	
I_{D25}	drain current	$V_{GS} = 20 V$			90	A	
I_{D80}			$T_C = 25^\circ C$			67	A
I_{D100}			$T_C = 80^\circ C$			56	A
$R_{DS(on)}$	static drain source on resistance	$I_D = 100 A; V_{GS} = 20 V$	$T_{VJ} = 25^\circ C$		23	35	mΩ
			$T_{VJ} = 150^\circ C$		45		mΩ
$V_{GS(th)}$	gate threshold voltage	$I_D = 36 mA; V_{GS} = V_{DS}$	$T_{VJ} = 25^\circ C$	2.0	2.4	4.0	V
			$T_{VJ} = 150^\circ C$		1.8		V
I_{DSS}	drain source leakage current	$V_{DS} = 1700 V; V_{GS} = 0 V$ $T_{VJ} = 25^\circ C$		5	200	μA	
I_{GSS}	gate source leakage current	$V_{DS} = 0 V; V_{GS} = 20 V$ $T_{VJ} = 25^\circ C$			1.2	μA	
R_G	internal gate resistance	$f = 1 MHz, V_{AC} = 25 mV, ESR \text{ of } C_{ISS}$		1.9		Ω	
C_{ISS}	input capacitance	$V_{DS} = 1000 V; V_{GS} = 0 V; f = 1 MHz T_{VJ} = 25^\circ C$		7340		pF	
C_{OSS}	output capacitance			342		pF	
C_{RSS}	reverse transfer (Miller) capacitance			13.5		pF	
Q_g	total gate charge	$V_{DS} = 1200 V; I_D = 100A; V_{GS} = -5/20 V$ $T_{VJ} = 25^\circ C$		376		nC	
Q_{gs}	gate source charge			88		nC	
Q_{gd}	gate drain (Miller) charge			114		nC	
$t_{d(on)}$	turn-on delay time	Inductive switching $V_{DS} = 1200 V; I_D = 70 A$ $T_{VJ} = 25^\circ C$ $V_{GS} = -5 / 20 V; R_G = 2.5 \Omega$ (external) Free wheeling diode: Body diode @ $V_{GS} = -5 V$		34		ns	
t_r	current rise time			13		ns	
$t_{d(off)}$	turn-off delay time			75		ns	
t_f	current fall time			27		ns	
E_{on}	turn-on energy per pulse			2.58		mJ	
E_{off}	turn-off energy per pulse			0.77		mJ	
$E_{rec(off)}$	reverse recovery losses at turn-off			0.66		mJ	
$t_{d(on)}$	turn-on delay time		Inductive switching $V_{DS} = 1200 V; I_D = 70 A$ $T_{VJ} = 150^\circ C$ $V_{GS} = -5 / 20 V; R_G = 2.5 \Omega$ (external) Free wheeling diode: Body diode @ $V_{GS} = -5 V$		36		ns
t_r	current rise time				13		ns
$t_{d(off)}$	turn-off delay time				105		ns
t_f	current fall time			33		ns	
E_{on}	turn-on energy per pulse			4.90		mJ	
E_{off}	turn-off energy per pulse			1.05		mJ	
$E_{rec(off)}$	reverse recovery losses at turn-off			1.89		mJ	
R_{thJC}	thermal resistance junction to case	with heatsink compound; IXYS test setup			0.30	0.22	K/W
R_{thJH}	thermal resistance junction to heatsink					K/W	

Source-Drain Diode				Ratings		
Symbol	Definitions	Conditions	min.	typ.	max.	
V_{SD}	forward voltage drop	$I_F = 70 A; V_{GS} = -5 V$	$T_{VJ} = 25^\circ C$	4.3		V
			$T_{VJ} = 150^\circ C$	3.8		V
t_{rr}	reverse recovery time	$V_{GS} = -5 V; I_F = 70 A; V_R = 1200 V$ $T_{VJ} = 25^\circ C$ Mosfet gate drive: $V_{GS} = -5 / 20 V; R_G = 2.5 \Omega$		24		ns
Q_{RM}	reverse recovery charge (intrinsic diode)			1.4		μC
I_{RM}	max. reverse recovery current			92		A
dI_F/dt	current slew rate			7300		A/ μs
t_{rr}	reverse recovery time	$V_{GS} = -5 V; I_F = 70 A; V_R = 1200 V$ $T_{VJ} = 150^\circ C$ Mosfet gate drive: $V_{GS} = -5 / 20 V; R_G = 2.5 \Omega$		38		ns
Q_{RM}	reverse recovery charge (intrinsic diode)			3.9		μC
I_{RM}	max. reverse recovery current			170		A
dI_F/dt	current slew rate			6350		A/ μs

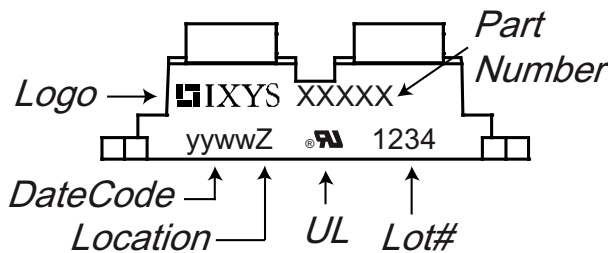
Note:

 When using SiC Body Diode the maximum recommended $V_{GS} = -5V$

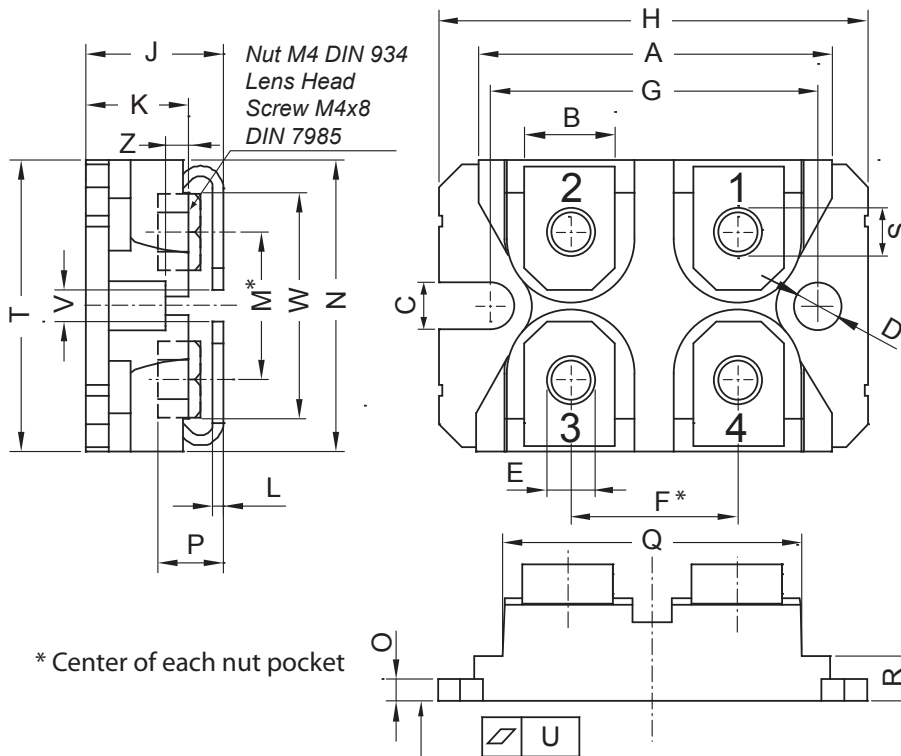
Package Outlines SOT-227B (minibloc)			Ratings			
Symbol	Definitions	Conditions	min.	typ.	max.	Unit
I_{RMS}	RMS current	per terminal			100	A
T_{stg}	storage temperature		-40		150	°C
T_{op}	operation temperature		-40		150	°C
T_{vJ}	virtual junction temperature		-40		175	°C
Weight				30		g
M_D	mounting torque ¹⁾	screws to heatsink terminal connection screws			1.5 1.3	Nm Nm
d_{Spp}	creepage distance on surface	terminal to terminal	10.5			mm
d_{Spb}		terminal to backside	8.5			mm
d_{App}	striking distance through air	terminal to terminal	3.2			mm
d_{Apb}		terminal to backside	6.8			mm
V_{ISOL}	isolation voltage	$I_{ISOL} \leq 1 \text{ mA}; 50/60 \text{ Hz}$	3000 2500			V V
C_p	coupling capacity per switch	between drain and back side metallization with gate and source shorted		42		pF

¹⁾ further information see application note IXAN0073 on www.ixys.com/TechnicalSupport/appnotes.aspx (General / Isolation, Mounting, Soldering, Cooling)

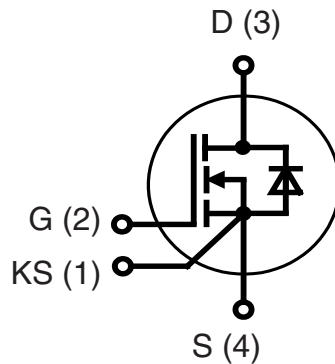
Product Marking

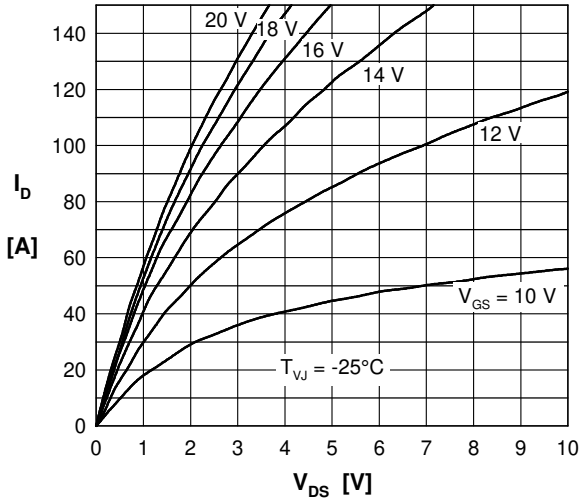
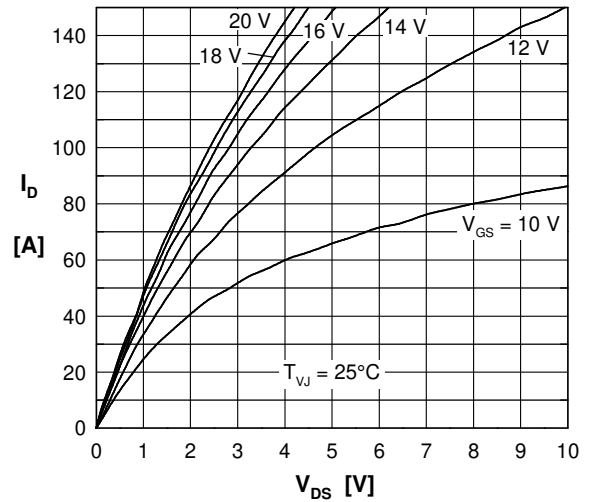
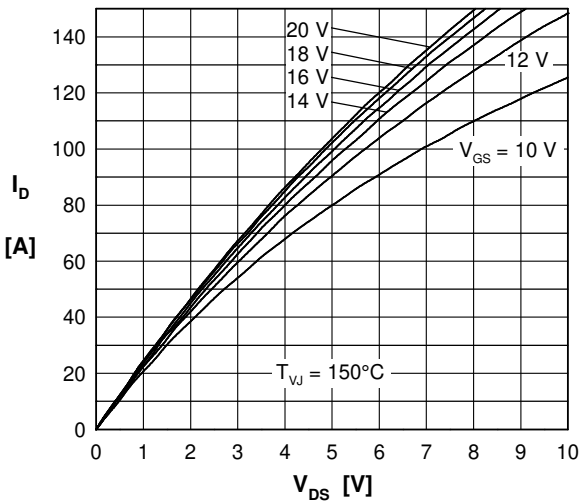
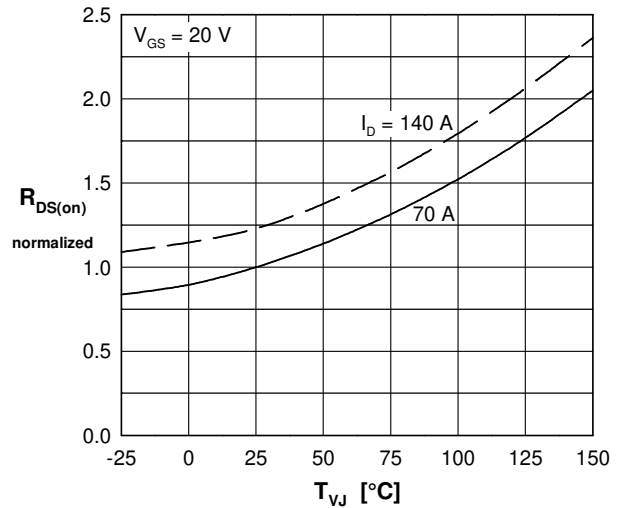
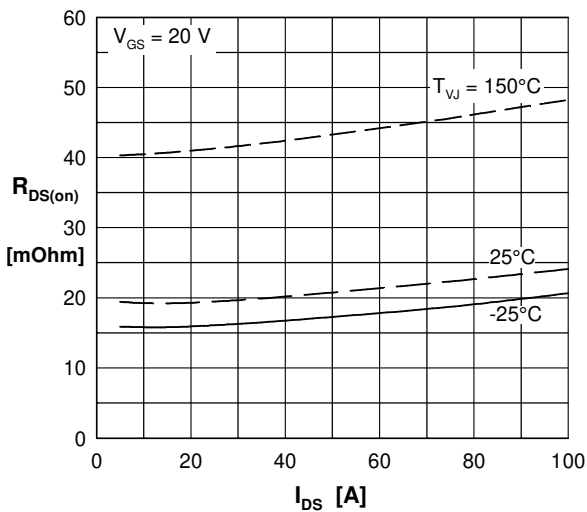
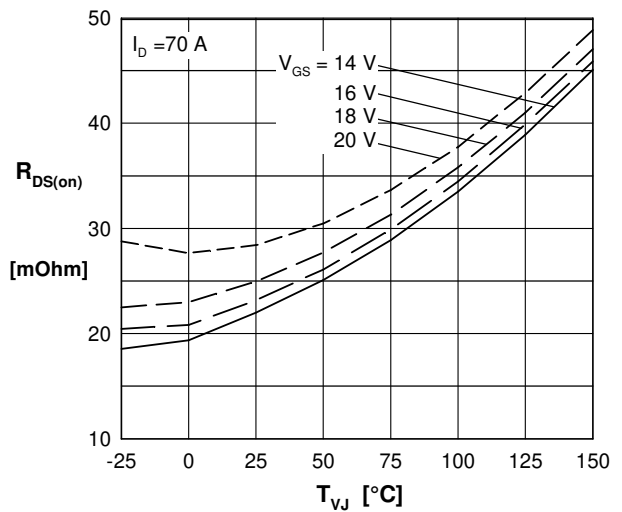


Ordering	Part Name	Marking on Product	Delivering Mode	Base Qty	Ordering Code
Standard	IXFN90N170SK	IXFN90N170SK	Tube	10	IXFN90N170SK

Outlines SOT-227B (minibloc)


Dim.	Millimeter		Inches	
	min	max	min	max
A	31.50	31.88	1.240	1.255
B	7.80	8.20	0.307	0.323
C	4.09	4.29	0.161	0.169
D	4.09	4.29	0.161	0.169
E	4.09	4.29	0.161	0.169
F	14.91	15.11	0.587	0.595
G	30.12	30.30	1.186	1.193
H	37.80	38.23	1.488	1.505
J	11.68	12.22	0.460	0.481
K	8.92	9.60	0.351	0.378
L	0.74	0.84	0.029	0.033
M	12.50	13.10	0.492	0.516
N	25.15	25.42	0.990	1.001
O	1.95	2.13	0.077	0.084
P	4.95	6.20	0.195	0.244
Q	26.54	26.90	1.045	1.059
R	3.94	4.42	0.155	0.167
S	4.55	4.85	0.179	0.191
T	24.59	25.25	0.968	0.994
U	-0.05	0.10	-0.002	0.004
V	3.20	5.50	0.126	0.217
W	19.81	21.08	0.780	0.830
Z	2.50	2.70	0.098	0.106



Curves

 Fig. 1 Typical output characteristics (-25°C)

 Fig. 2 Typical output characteristics (25°C)

 Fig. 3 Typical output characteristics (150°C)

 Fig. 4 $R_{DS(on)}$ normalized vs. junction temperature T_{VJ}

 Fig. 5 $R_{DS(on)}$ versus drain current

 Fig. 6 $R_{DS(on)}$ versus junction temperature T_{VJ}

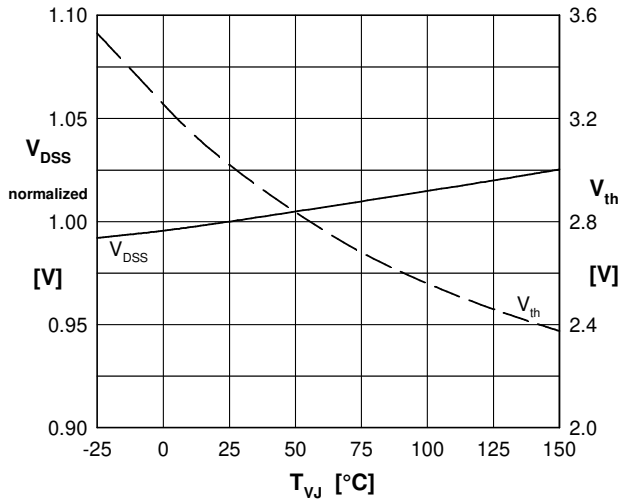
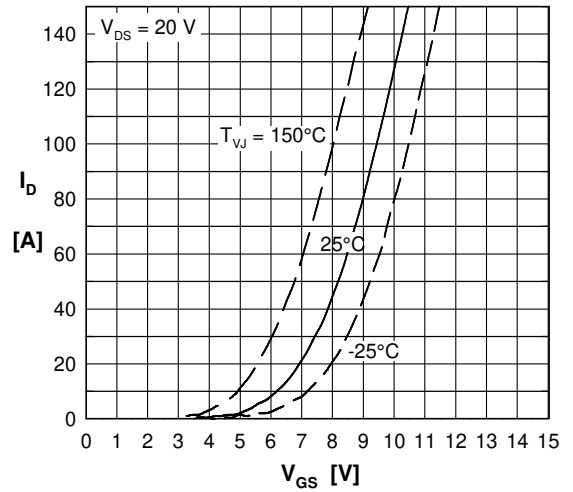
Curves

 Fig. 7 Threshold voltage V_{TH} and normalized V_{DSS} versus junction temperature T_{VJ}


Fig. 8 Typical transfer characteristics

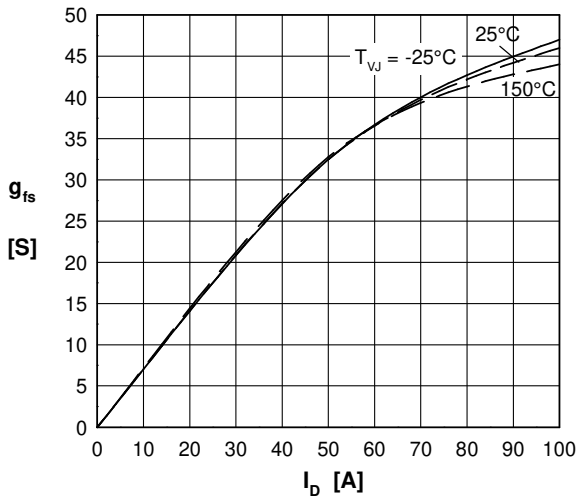
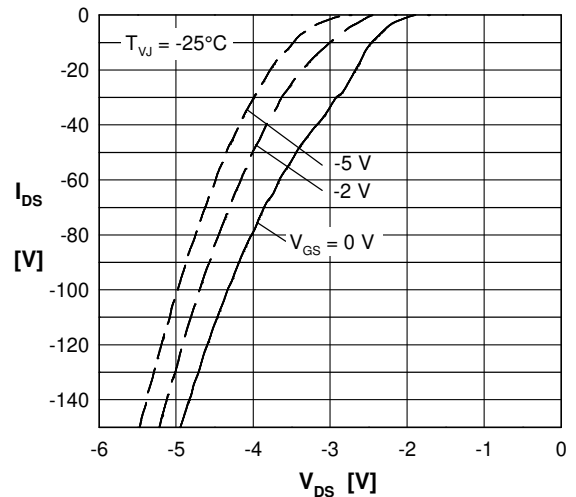
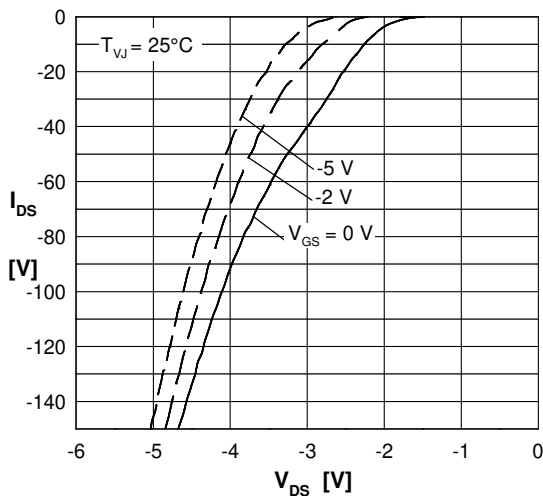
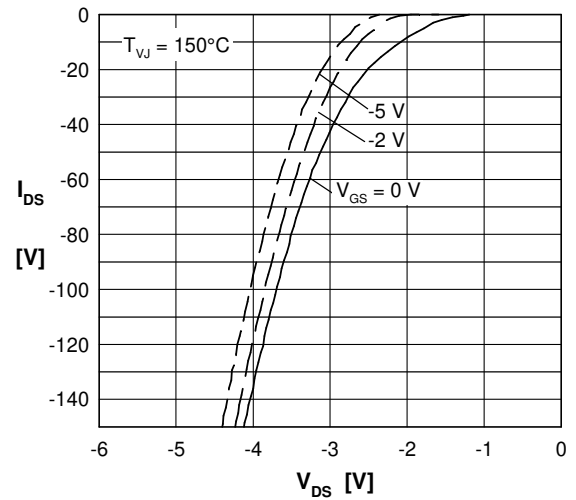


Fig. 9 Typical forward transconductance


 Fig. 10 Forward voltage drop of intrinsic diode versus V_{DS} measured at -25°C

 Fig. 11 Forward voltage drop of intrinsic diode versus V_{DS} measured at 25°C

 Fig. 12 Forward voltage drop of intrinsic diode versus V_{DS} measured at 150°C

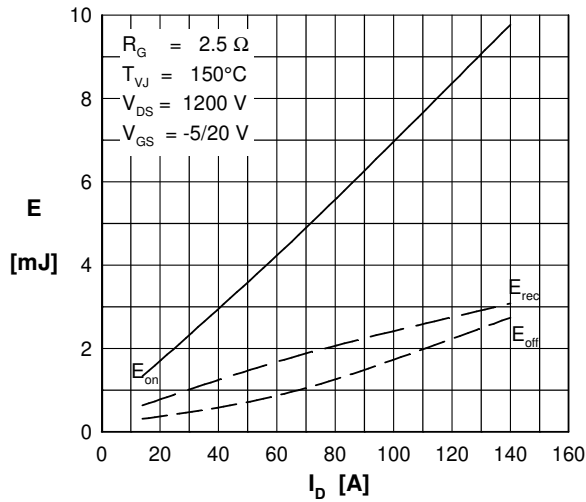
Curves


Fig. 13 Typical switching energy versus drain current

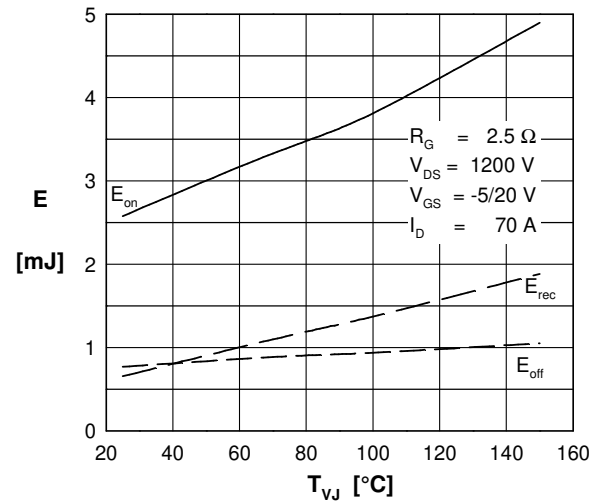


Fig. 14 Typical switching energy versus temperature

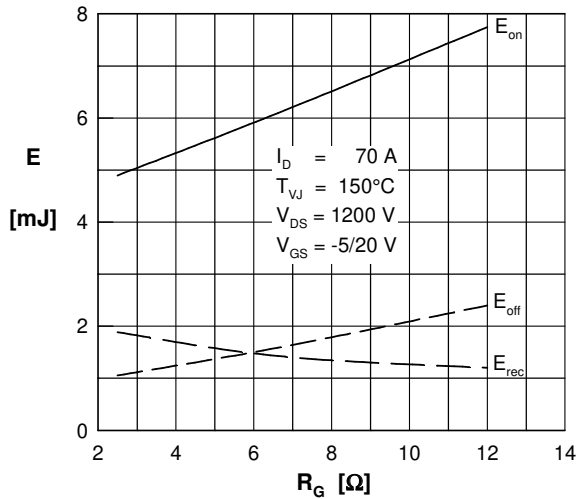


Fig. 15 Typical switching energy versus external gate resistor

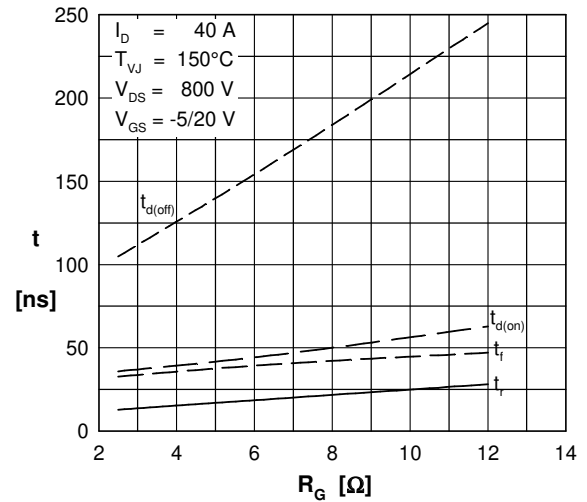


Fig. 16 Typical switching time versus external gate resistor

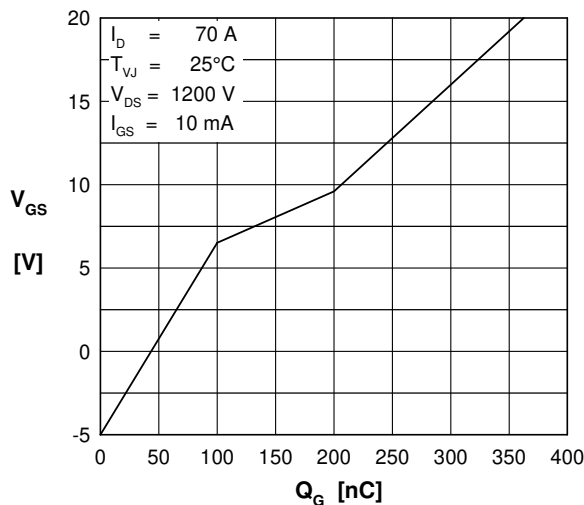


Fig. 17 Typical turn on gate charge, trendline

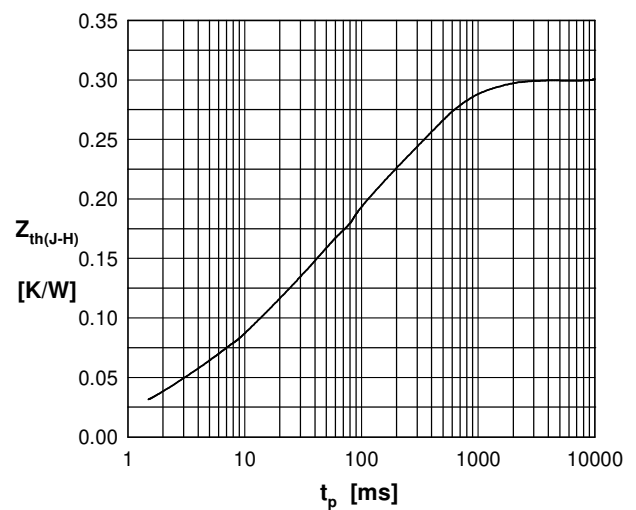


Fig. 18 Typical transient thermal impedance