



为您的产品保驾护航

PRODUCT DATASHEET

Electro-Static Discharge

JET23-xxV-C2 ESD

## Features

- Package: SOT-23
- 300W peak pulse power (8/20 $\mu$ s)
- Protects two bi-directional lines
- Ultra low leakage: nA level
- Operating voltage: 3.3V,5V,12V,15V,24,32V,36V
- Low clamping voltage
- Complies with following standards:
  - IEC 61000-4-2 (ESD) immunity test
    - Air discharge:  $\pm 30$ kV
    - Contact discharge:  $\pm 30$ kV
- RoHS compliant

## Applications

- Cellular Handsets and Accessories
- Notebooks and Handhelds
- Portable Instrumentation
- Set Top Box
- Industrial Controls
- Server and Desktop PC

## Pin Description

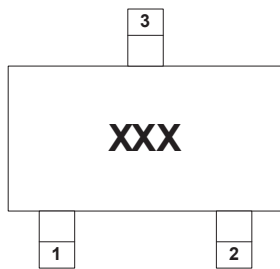

## Schematic Diagram

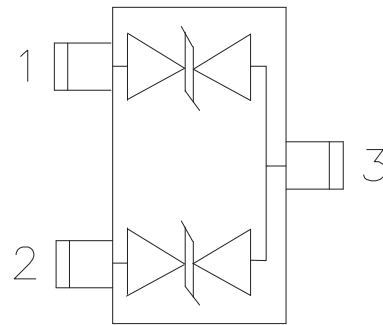

## Limiting Values( $T_A = 25\text{ }^\circ\text{C}$ , unless otherwise specified)

Symbol	Parameter	Conditions	Value	Unit
V <sub>ESD</sub>	Electrostatic Discharge Voltage	IEC 61000-4-2;Contact Discharge	$\pm 30$	kV
		IEC 61000-4-2;Air Discharge	$\pm 30$	kV
P <sub>PK</sub>	Peak Pulse Power	t <sub>P</sub> =8/20 $\mu$ s	300	W
T <sub>J</sub>	Operating Temperature Range	-	-55 to +125	$^\circ\text{C}$
T <sub>stg</sub>	Storage Temperature Range	-	-55 to +150	$^\circ\text{C}$

**Electrical Characteristics(T<sub>A</sub> = 25 °C, unless otherwise specified)**

Part NO.	JET23-3.3V-C2					
Symbol	Parameter	Conditions	Min	Typ.	Max	Unit
V <sub>RWM</sub>	Reverse Working Voltage	T <sub>A</sub> =25°C	-	-	3.3	V
V <sub>BR</sub>	Breakdown Voltage	I <sub>T</sub> =1mA	3.8	-	-	V
I <sub>R</sub>	Reverse Leakage Current	V <sub>RWM</sub> =3.3V	-	-	1.0	μA
V <sub>C</sub>	Clamping Voltage	I <sub>PP</sub> =1A(8x20μs pulse)	-	-	6	V
V <sub>C</sub>	Clamping Voltage	I <sub>PP</sub> =25A(8x20μs pulse)	-	-	12	V
I <sub>pp</sub>	Peak Pulse Current	t <sub>p</sub> =8/20μs	-	-	25	A
C <sub>J</sub>	Junction Capacitance	V <sub>R</sub> =0V,f=1 MHz,Pin 1 to Pin 3 or Pin 2 to Pin 3	-	-	100	pF

Part NO.	JET23-5V-C2					
Symbol	Parameter	Conditions	Min	Typ.	Max	Unit
V <sub>RWM</sub>	Reverse Working Voltage	T <sub>A</sub> =25°C	-	-	5	V
V <sub>BR</sub>	Breakdown Voltage	I <sub>T</sub> =1mA	6	-	-	V
I <sub>R</sub>	Reverse Leakage Current	V <sub>RWM</sub> =5V	-	-	1.0	μA
V <sub>C</sub>	Clamping Voltage	I <sub>PP</sub> =1A(8x20μs pulse)	-	-	8	V
V <sub>C</sub>	Clamping Voltage	I <sub>PP</sub> =20A(8x20μs pulse)	-	-	15	V
I <sub>pp</sub>	Peak Pulse Current	t <sub>p</sub> =8/20μs	-	-	20	A
C <sub>J</sub>	Junction Capacitance	V <sub>R</sub> =0V,f=1 MHz,Pin 1 to Pin 3 or Pin 2 to Pin 3	-	-	80	pF

Part NO.	JET23-12V-C2					
Symbol	Parameter	Conditions	Min	Typ.	Max	Unit
V <sub>RWM</sub>	Reverse Working Voltage	T <sub>A</sub> =25°C	-	-	12	V
V <sub>BR</sub>	Breakdown Voltage	I <sub>T</sub> =1mA	13.3	-	-	V
I <sub>R</sub>	Reverse Leakage Current	V <sub>RWM</sub> =12V	-	-	0.5	μA
V <sub>C</sub>	Clamping Voltage	I <sub>PP</sub> =1A(8x20μs pulse)	-	-	18	V
V <sub>C</sub>	Clamping Voltage	I <sub>PP</sub> =12A(8x20μs pulse)	-	-	25	V
I <sub>pp</sub>	Peak Pulse Current	t <sub>p</sub> =8/20μs	-	-	12	A
C <sub>J</sub>	Junction Capacitance	V <sub>R</sub> =0V,f=1 MHz,Pin 1 to Pin 3 or Pin 2 to Pin 3	-	-	50	pF

Part NO.	JET23-15V-C2					
Symbol	Parameter	Conditions	Min	Typ.	Max	Unit
V <sub>RWM</sub>	Reverse Working Voltage	T <sub>A</sub> =25°C	-	-	15	V
V <sub>BR</sub>	Breakdown Voltage	I <sub>T</sub> =1mA	16.7	-	-	V
I <sub>R</sub>	Reverse Leakage Current	V <sub>RWM</sub> =15V	-	-	0.5	μA
V <sub>C</sub>	Clamping Voltage	I <sub>PP</sub> =1A(8x20μs pulse)	-	-	20	V
V <sub>C</sub>	Clamping Voltage	I <sub>PP</sub> =8A(8x20μs pulse)	-	-	37.5	V
I <sub>pp</sub>	Peak Pulse Current	t <sub>p</sub> =8/20μs	-	-	8	A
C <sub>J</sub>	Junction Capacitance	V <sub>R</sub> =0V,f=1 MHz,Pin 1 to Pin 3 or Pin 2 to Pin 3	-	-	40	pF

Part NO.	JET23-24V-C2					
Symbol	Parameter	Conditions	Min	Typ.	Max	Unit
V <sub>RWM</sub>	Reverse Working Voltage	T <sub>A</sub> =25°C	-	-	24	V
V <sub>BR</sub>	Breakdown Voltage	I <sub>T</sub> =1mA	27	-	-	V
I <sub>R</sub>	Reverse Leakage Current	V <sub>RWM</sub> =24V	-	-	0.2	μA
V <sub>C</sub>	Clamping Voltage	I <sub>PP</sub> =1A(8x20μs pulse)	-	-	40	V
V <sub>C</sub>	Clamping Voltage	I <sub>PP</sub> =5A(8x20μs pulse)	-	-	60	V
I <sub>pp</sub>	Peak Pulse Current	t <sub>p</sub> =8/20μs	-	-	5	A
C <sub>J</sub>	Junction Capacitance	V <sub>R</sub> =0V,f=1 MHz,Pin 1 to Pin 3 or Pin 2 to Pin 3	-	15	30	pF

Part NO.	JET23-32V-C2					
Symbol	Parameter	Conditions	Min	Typ.	Max	Unit
V <sub>RWM</sub>	Reverse Working Voltage	T <sub>A</sub> =25°C	-	-	32	V
V <sub>BR</sub>	Breakdown Voltage	I <sub>T</sub> =1mA	35.6	-	-	V
I <sub>R</sub>	Reverse Leakage Current	V <sub>RWM</sub> =36V	-	-	0.2	μA
V <sub>C</sub>	Clamping Voltage	I <sub>PP</sub> =1A(8x20μs pulse)	-	-	45	V
V <sub>C</sub>	Clamping Voltage	I <sub>PP</sub> =4.5A(8x20μs pulse)	-	-	67	V
I <sub>pp</sub>	Peak Pulse Current	t <sub>p</sub> =8/20μs	-	-	4	A
C <sub>J</sub>	Junction Capacitance	V <sub>R</sub> =0V,f=1 MHz,Pin 1 to Pin 3 or Pin 2 to Pin 3	-	15	25	pF

Part NO.	JET23-36V-C2					
Symbol	Parameter	Conditions	Min	Typ.	Max	Unit
V <sub>RWM</sub>	Reverse Working Voltage	T <sub>A</sub> =25°C	-	-	36	V
V <sub>BR</sub>	Breakdown Voltage	I <sub>T</sub> =1mA	38	-	-	V
I <sub>R</sub>	Reverse Leakage Current	V <sub>RWM</sub> =36V	-	-	0.2	μA
V <sub>C</sub>	Clamping Voltage	I <sub>PP</sub> =1A(8x20μs pulse)	-	-	50	V
V <sub>C</sub>	Clamping Voltage	I <sub>PP</sub> =4A(8x20μs pulse)	-	-	75	V
I <sub>pp</sub>	Peak Pulse Current	t <sub>p</sub> =8/20μs	-	-	4	A
C <sub>J</sub>	Junction Capacitance	V <sub>R</sub> =0V,f=1 MHz,Pin 1 to Pin 3 or Pin 2 to Pin 3	-	12	20	pF

### Typical Characteristics

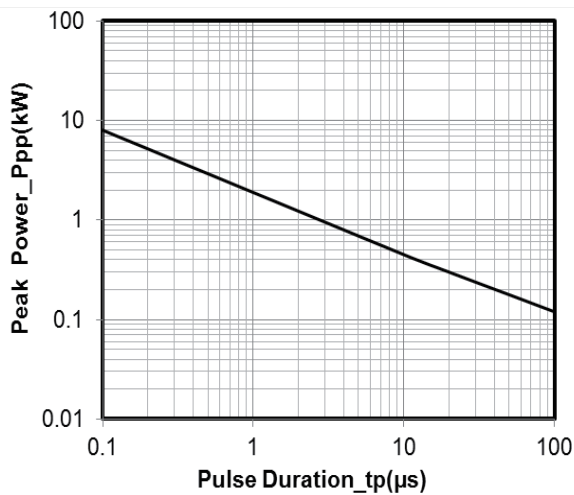

Peak Pulse Power vs. Pulse Time

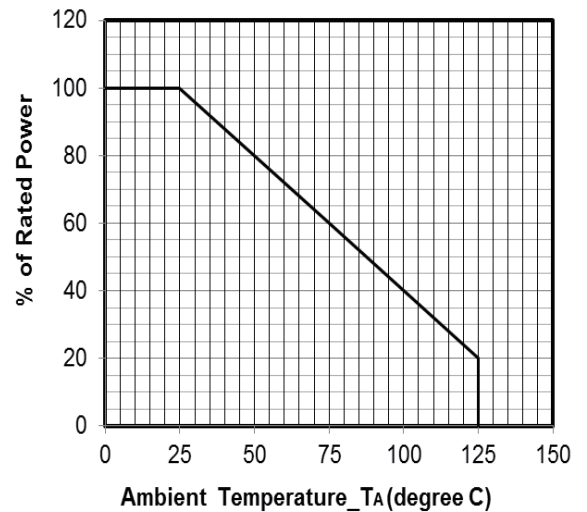

Power Derating Curve

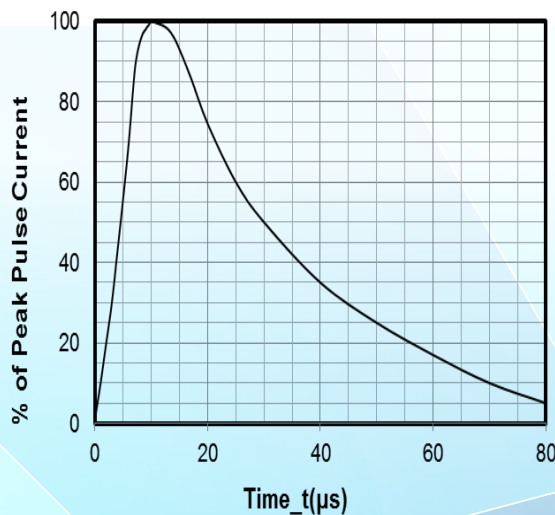

8 X 20 μs Pulse Waveform

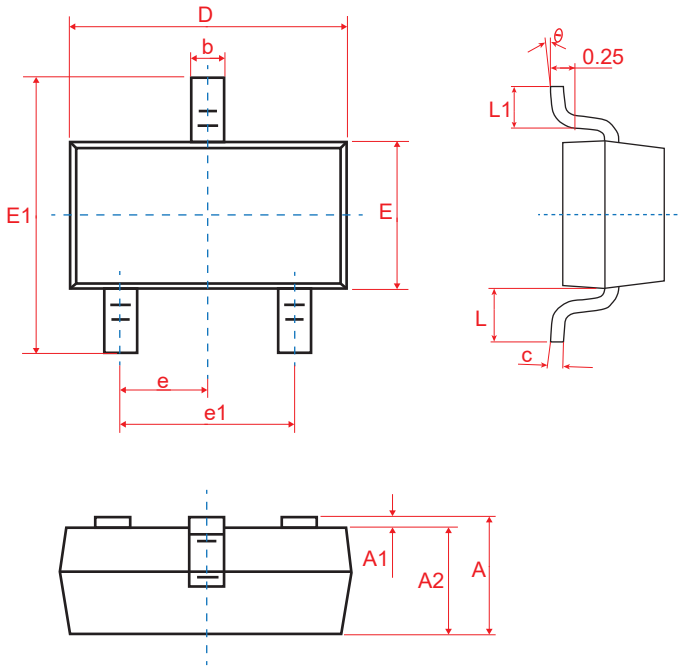
**Physical Dimensions(mm.)**

Symbol	Dimensions In Millimeters		Dimensions In Inches	
	Min	Max	Min	Max
A	0.90	1.15	0.035	0.045
A1	0.00	0.10	0.000	0.004
A2	0.90	1.05	0.035	0.041
b	0.30	0.50	0.012	0.020
c	0.08	0.15	0.003	0.006
D	2.80	3.00	0.110	0.118
E	1.20	1.40	0.047	0.055
E1	2.25	2.55	0.089	0.100
e	0.95 TYP		0.037 TYP	
e1	1.80	2.00	0.071	0.079
L	0.55 REF		0.022 REF	
L1	0.30	0.50	0.012	0.020
e	0°	8°	0°	8°

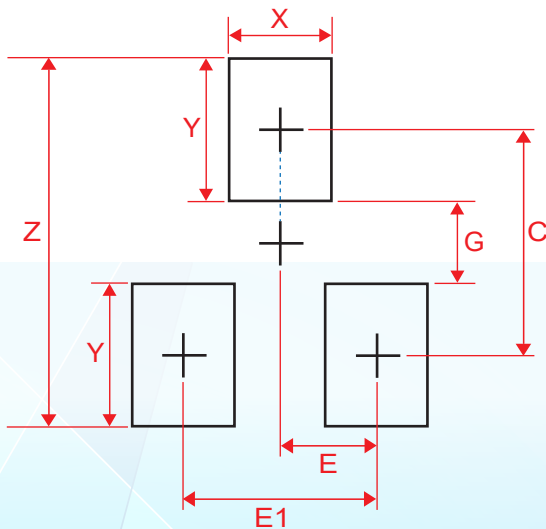
**Suggested Land Pattern**

Symbol	Dimensions	
	Inches	Millimeters
C	0.087	2.20
E	0.037	0.95
E1	0.075	1.90
G	0.031	0.80
X	0.039	1.00
Y	0.055	1.40
Z	0.141	3.60

**Packaging Quantity**

Part Number	Delivery Form	Delivery Quantity
JET23-xxV-C2	7"T&R	3,000

### Soldering Parameters

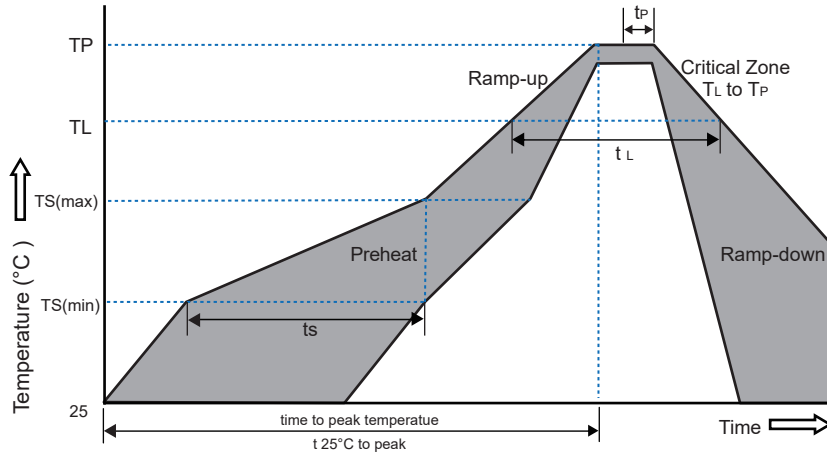

Reflow Condition		Pb-Free Assembly
Pre-heat	-Temperature Min( $T_{s(min)}$ )	+150°C
	-Temperature Max( $T_{s(max)}$ )	+200°C
	-Time(Min to Max)( $t_s$ )	60~180 secs.
Average ramp up rate (Liquid us Temp( $T_L$ ) to peak)		3°C/sec. Max
Ts(max) to $T_L$ - Ramp-up Rate		3°C/sec. Max
Reflow	-Temperature( $T_L$ )(Liquid us)	+217°C
	-Temperature ( $t_L$ )	60~150 secs.
Peak Temp ( $T_P$ )		+260(+0/-5)°C
Time within 5°C of actual Peak Temp ( $t_p$ )		30 secs. Max
Ramp-down Rate		6°C/sec. Max
xTime 25°C to Peak Temp (TP)		8 min. Max
Do not exceed		+260°C

### Part Number System

## JE T23 - xxV-C 2

