

DESCRIPTION

The TLV263x single supply operational amplifiers provide rail-to-rail output with an input range that includes ground. The TLV263x takes the minimum operating supply voltage down to 2.7 V over the extended industrial temperature range (-40°C to 125°C) while adding the rail-to-rail output swing feature. The TLV263x also provides a 9 MHz gain-bandwidth product from only 730 µA of supply current. The maximum recommended supply voltage is 5.5 V, which, when coupled with a 2.7-V minimum, allows the devices to be operated from lithium ion cells.

The combination of wide bandwidth, low noise, and low distortion makes it ideal for high speed and high resolution data converter applications. The ground input range allows it to directly interface to ground rail referred systems.

FEATURES

- Rail-To-Rail Output
- V_{ICR} Includes Ground
- Gain-Bandwidth Product . . . 9 MHz
- Supply Current . . . 730 µA/Channel
- Single, Duals, and Quad Versions
- Ultralow Power Down Mode
 $I_{DD}(SHDN) = 4 \mu\text{A}/\text{Channel}$
- Specified Temperature Range
-40°C to 125°C . . . Industrial Grade
- Supply Voltage Range . . . 2.7 V to 5.5 V

TLV263x PACKAGE PINOUTS

TLV2631
SOP-8

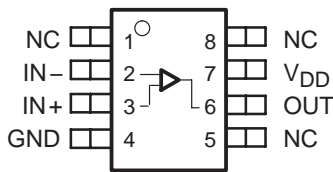

TLV2632
SOP-8

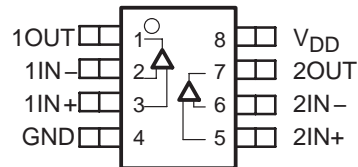

TLV2631
SOT23-5

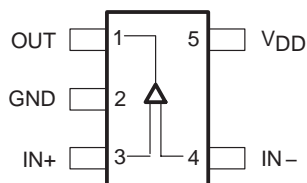

TLV2634
TSSOP-14/SOP-14

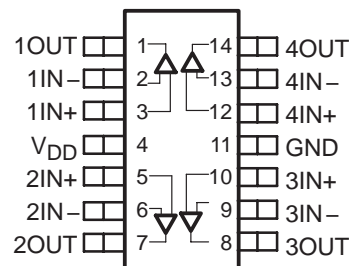

NC – No internal connection

Recommended operating conditions

		MIN	MAX	UNIT
Supply voltage, V_{DD}	Single supply	2.7	5.5	V
	Split supply	± 1.35	± 2.75	
Common-mode input voltage range, V_{ICR}		GND	$V_{DD}-1$	V
Operating free-air temperature, T_A	I-suffix	-40	125	$^{\circ}\text{C}$
	V_{IL}		0.4	
	V_{IH}	2		

‡ Relative to GND.

Electrical characteristics at specified free-air temperature, $V_{DD} = 2.7\text{ V}, 5\text{ V}$ (unless otherwise noted) dc performance

PARAMETER	TEST CONDITIONS	T_A	MIN	TYP	MAX	UNIT	
V_{IO} Input offset voltage	$V_{IC} = V_{DD}/2,$ $V = V/2$	25 $^{\circ}\text{C}$		250	3500	μV	
		Full range			4500		
		TLV2634	25 $^{\circ}\text{C}$		250	4200	μV
			Full range			5200	
α_{VIO} Temperature coefficient of input offset voltage		25 $^{\circ}\text{C}$		3		$\mu\text{V}/^{\circ}\text{C}$	
CMRR Common-mode rejection ratio	$V_{IC} = \text{GND to } V_{DD}-1\text{ V}$	$V_{DD} = 2.7\text{ V}$	25 $^{\circ}\text{C}$	76	100	dB	
			Full range	67			
		$V_{DD} = 5\text{ V}$	25 $^{\circ}\text{C}$	77	100		
			Full range	74			
A_{VD} Large-signal differential voltage amplification	$R_L = 2\text{ k}\Omega, V_{O(PP)} = V_{DD}-1\text{ V}$	25 $^{\circ}\text{C}$	90	100	dB		
		Full range	82				

**Electrical characteristics at specified free-air temperature,
 $V_{DD} = 2.7\text{ V}, 5\text{ V}$ (unless otherwise noted) (continued)
input characteristics**

PARAMETER	TEST CONDITIONS	T_A †	MIN	TYP	MAX	UNIT
I_{IO} Input offset current	$V_{IC} = V_{DD}/2,$ $V_O = V_{DD}/2$	25°C		1	50	pA
		Full range			100	
I_{IB} Input bias current		25°C		1	50	
		Full range			200	
$r_{i(d)}$ Differential input resistance		25°C		1000		GΩ
$C_{i(c)}$ Common-mode input capacitance	$f = 1\text{ kHz}$	25°C		12		pF

† Full range is -40°C to 125°C for the I-suffix.

Output characteristics

PARAMETER	TEST CONDITIONS	T_A †	MIN	TYP	MAX	UNIT		
V_{OH} High-level output voltage	$V_{IC} = V_{DD}/2, I_{OH} = -1\text{ mA}$	$V_{DD} = 2.7\text{ V}$	25°C	2.6	2.67	V		
		Full range	2.55					
			$V_{DD} = 5\text{ V}$	25°C	4.92		4.98	
	$V_{IC} = V_{DD}/2, I_{OH} = -10\text{ mA}$	Full range	4.9					
			$V_{DD} = 2.7\text{ V}$	25°C	2.25		2.43	
		Full range	2.15					
$V_{DD} = 5\text{ V}$	25°C		4.7	4.8				
V_{OL} Low-level output voltage	$V_{IC} = V_{DD}/2, I_{OL} = 1\text{ mA}$	$V_{DD} = 2.7\text{ V}$	25°C		0.03	0.1	mV	
		Full range				0.15		
			$V_{DD} = 5\text{ V}$	25°C		0.025		0.08
	$V_{IC} = V_{DD}/2, I_{OL} = 10\text{ mA}$	Full range	0.1					
			$V_{DD} = 2.7\text{ V}$	25°C		0.26		0.45
		Full range	0.47					
$V_{DD} = 5\text{ V}$	25°C			0.2	0.3			
I_O Output current	$V_{DD} = 2.7\text{ V},$ $V_O = 0.5\text{ V}$ from rail	Sourcing	25°C		14	mA		
				Sinking	19			
		$V_{DD} = 5\text{ V},$ $V_O = 0.5\text{ V}$ from rail		Sourcing	28			
	Sinking			28				
	I_{OS} Short-circuit output current	Sourcing		$V_{DD} = 2.7\text{ V}$	25°C		50	mA
				$V_{DD} = 5\text{ V}$	95			
Sinking		$V_{DD} = 2.7\text{ V}$	50					
		$V_{DD} = 5\text{ V}$	95					

† Full range is -40°C to 125°C for the I-suffix.

Power supply

PARAMETER	TEST CONDITIONS	T_A †	MIN	TYP	MAX	UNIT
I_{DD} Supply current (per channel)	$V_O = V_{DD}/2,$ $\overline{SHDN} = V_{DD}$	25°C		730	1000	μA
		Full range			1350	
PSRR Supply voltage rejection ratio ($\Delta V_{DD} / \Delta V_{IO}$)	$V_{DD} = 2.7\text{ V}$ to $5.5\text{ V},$ $V_{IC} = V_{DD}/2$	No load	25°C	70	90	dB
			Full range	65		

† Full range is -40°C to 125°C for the I-suffix.

Electrical characteristics at specified free-air temperature, $V_{DD} = 2.7\text{ V}, 5\text{ V}$ (unless otherwise noted) (continued)
Dynamic performance

PARAMETER	TEST CONDITIONS	T_A †	MIN	TYP	MAX	UNIT	
GBWP Gain-bandwidth product	$R_L = 2\text{ k}\Omega, C_L = 10\text{ pF}, f = 10\text{ kHz}$	25°C		9		MHz	
SR+ Positive slew rate at unity gain	$R_L = 2\text{ k}\Omega, C_L = 50\text{ pF}$		$V_{DD} = 2.7\text{ V}, V_{O(PP)} = 1.7\text{ V}$		6		V/ μs
			$V_{DD} = 5\text{ V}, V_{O(PP)} = 3.5\text{ V}$		6		
SR- Negative slew rate at unity gain	$R_L = 2\text{ k}\Omega, C_L = 50\text{ pF}$		$V_{DD} = 2.7\text{ V}, V_{O(PP)} = 1.7\text{ V}$		10		V/ μs
			$V_{DD} = 5\text{ V}, V_{O(PP)} = 3.5\text{ V}$		9.5		V/ μs
ϕ_m Phase margin	$R_L = 2\text{ k}\Omega, C_L = 10\text{ pF}$				50		°
Gain margin				20		dB	

† Full range is -40°C to 125°C for the I-suffix.

Noise/distortion performance

PARAMETER	TEST CONDITIONS	T_A	MIN	TYP	MAX	UNIT	
THD + N Total harmonic distortion plus noise	$V_{O(PP)} = V_{DD}/2, R_L = 2\text{ k}\Omega, f = 10\text{ kHz}$	25°C		0.003%			
			$A_V = 10$		0.02%		
			$A_V = 100$		0.095%		
V_n Equivalent input noise voltage	$f = 1\text{ kHz}$	25°C		50		nV/ $\sqrt{\text{Hz}}$	
	$f = 10\text{ kHz}$			30			
I_n Equivalent input noise current	$f = 1\text{ kHz}$	25°C		0.9		fA/ $\sqrt{\text{Hz}}$	

Shutdown characteristics

PARAMETER	TEST CONDITIONS	T_A †	MIN	TYP	MAX	UNIT
$I_{DD(SHDN)}$ Supply current, per channel in shutdown mode (TLV2630, TLV2633, TLV2635)	$\overline{\text{SHDN}} = 0.4\text{ V}$	25°C		4	17	μA
		Full range			19	
$t_{(on)}$ Amplifier turnon time‡	$R_L = 2\text{ k}\Omega, C_L = 10\text{ pF}$	25°C		4.5		μs
$t_{(off)}$ Amplifier turnoff time‡				1.5		
				200		ns

† Full range is -40°C to 125°C for the I-suffix.

‡ Disable time and enable time are defined as the interval between application of the logic signal to $\overline{\text{SHDN}}$ and the point at which the supply current has reached half its final value.

TYPICAL CHARACTERISTICS

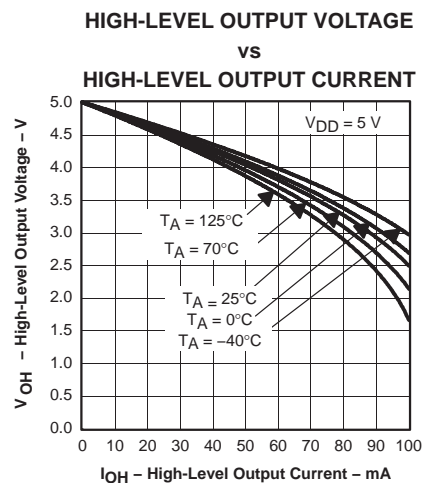
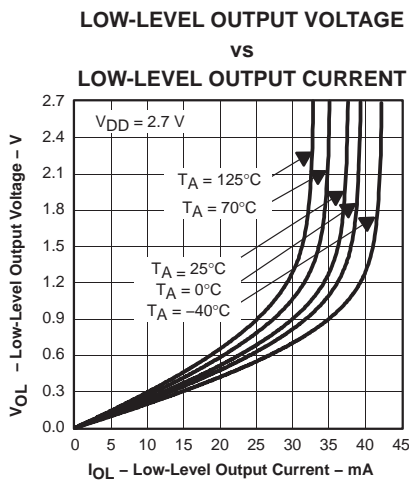
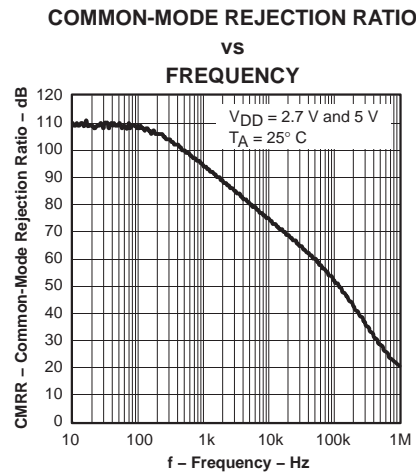
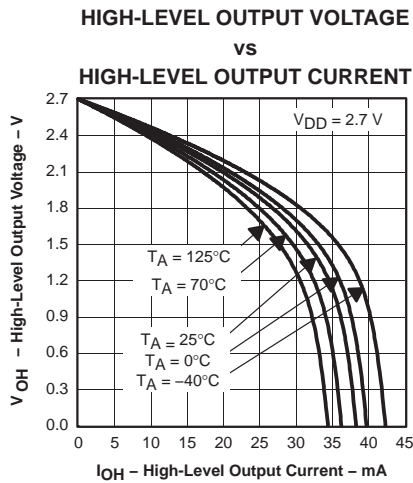
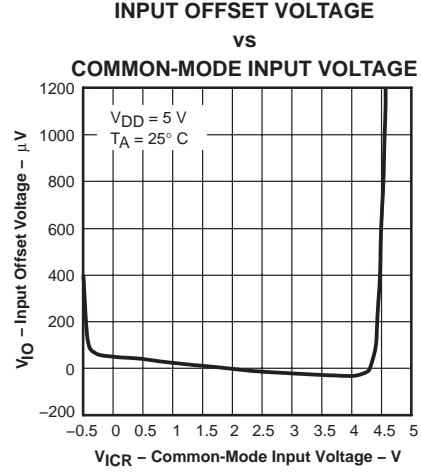
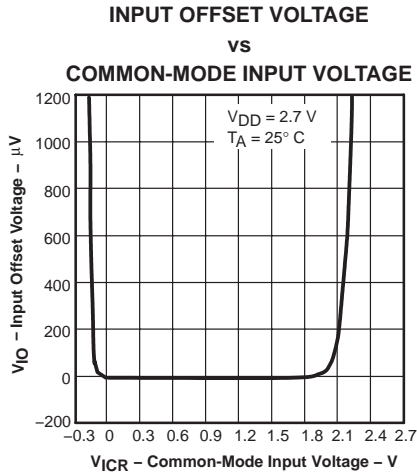

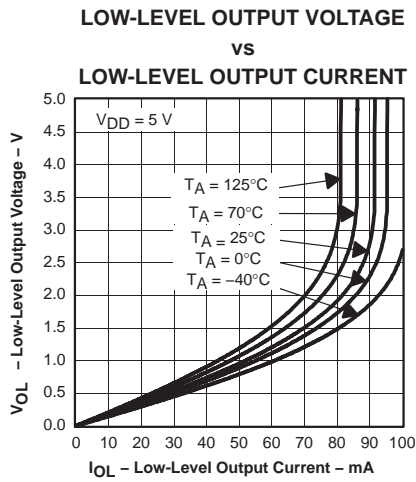

Figure 7

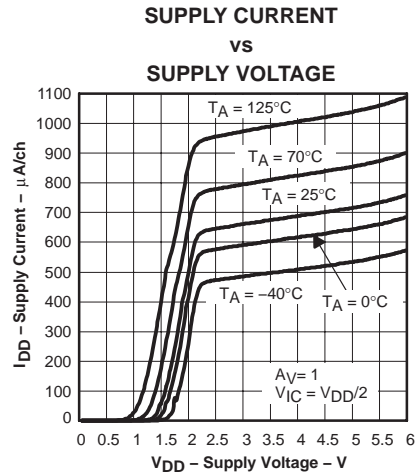

Figure 8

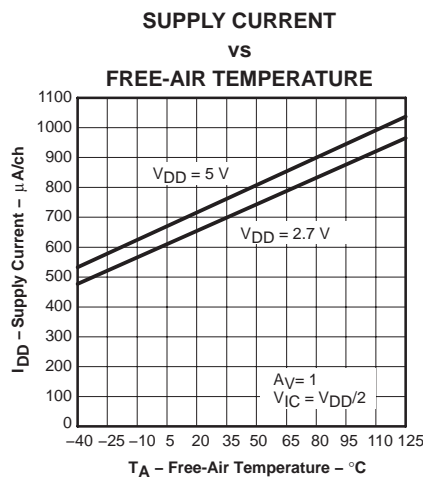

Figure 9

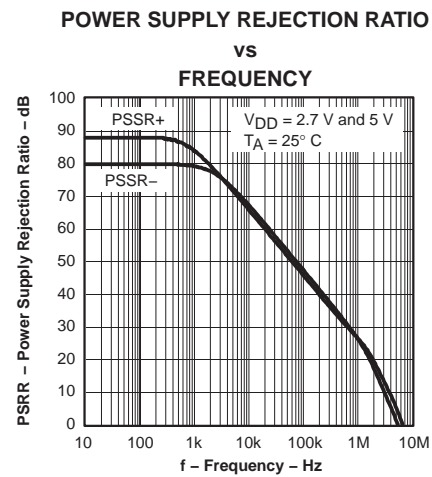

Figure 10

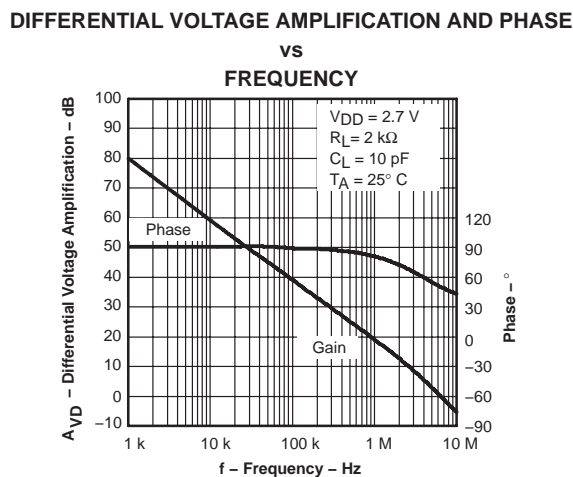

Figure 11

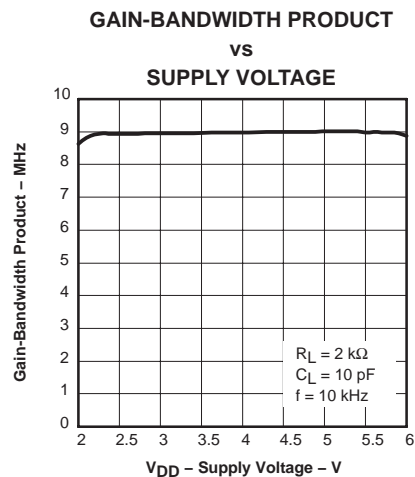

Figure 12

TYPICAL CHARACTERISTICS

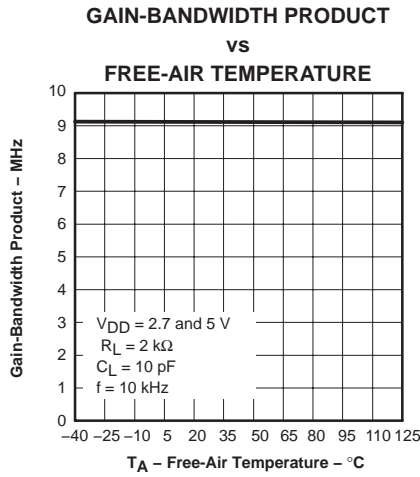

Figure 13

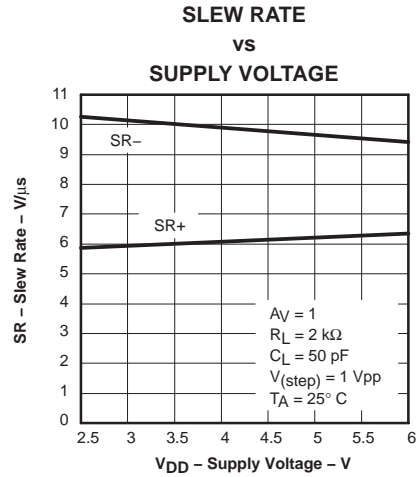

Figure 14

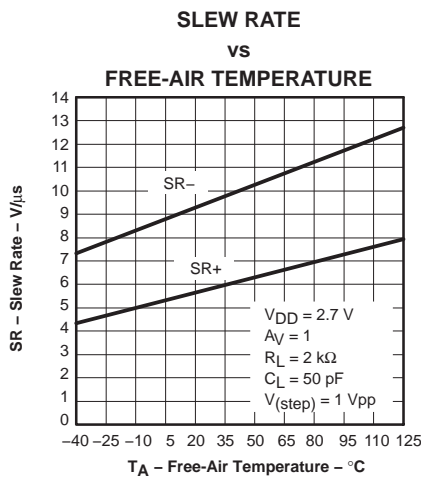

Figure 15

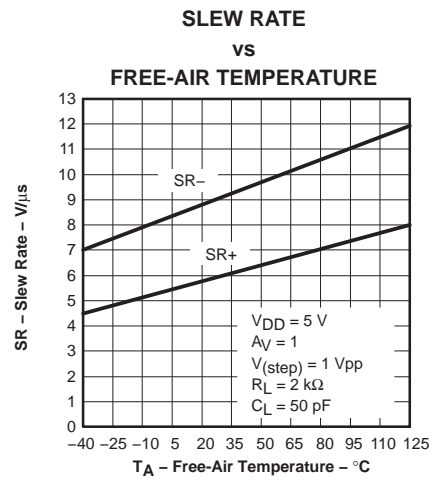

Figure 16

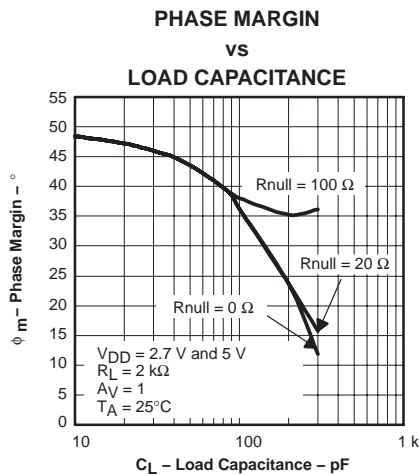

Figure 17

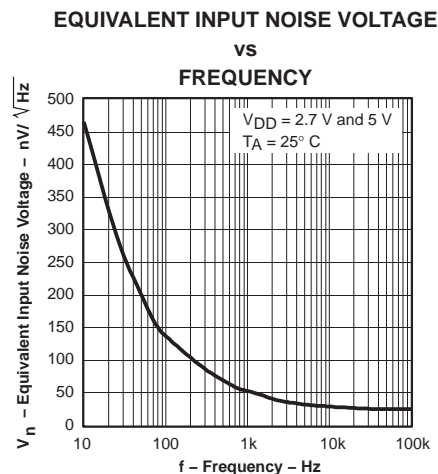

Figure 18

TYPICAL CHARACTERISTICS

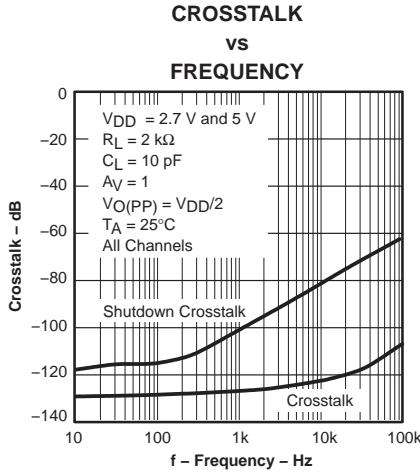

Figure 19

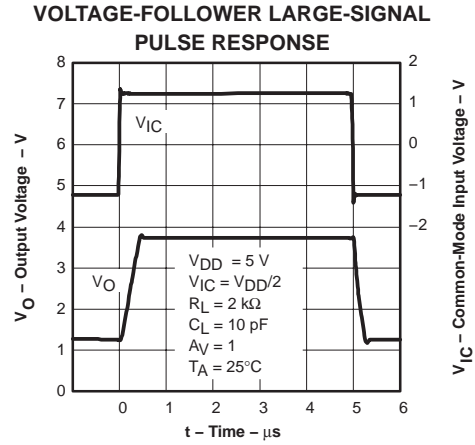

Figure 20

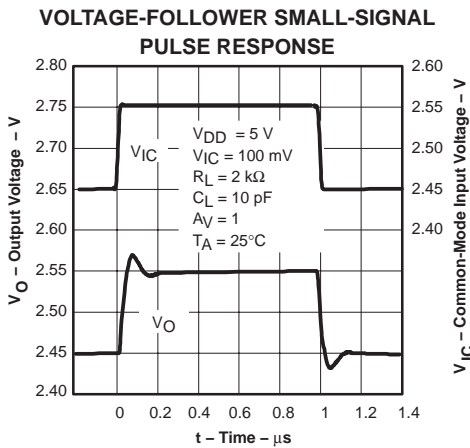

Figure 21

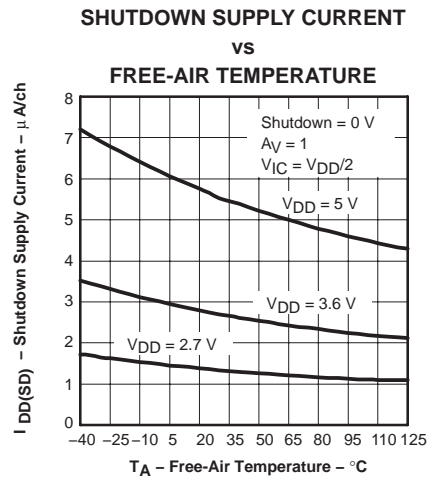

Figure 22

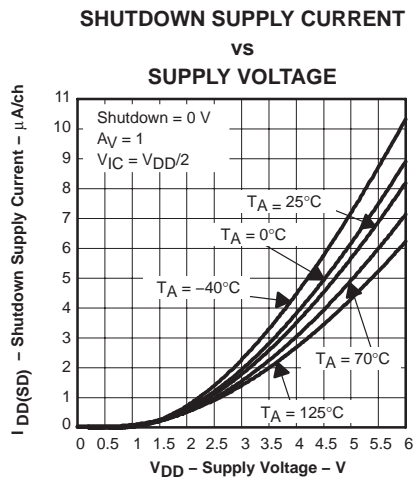

Figure 23

TYPICAL CHARACTERISTICS

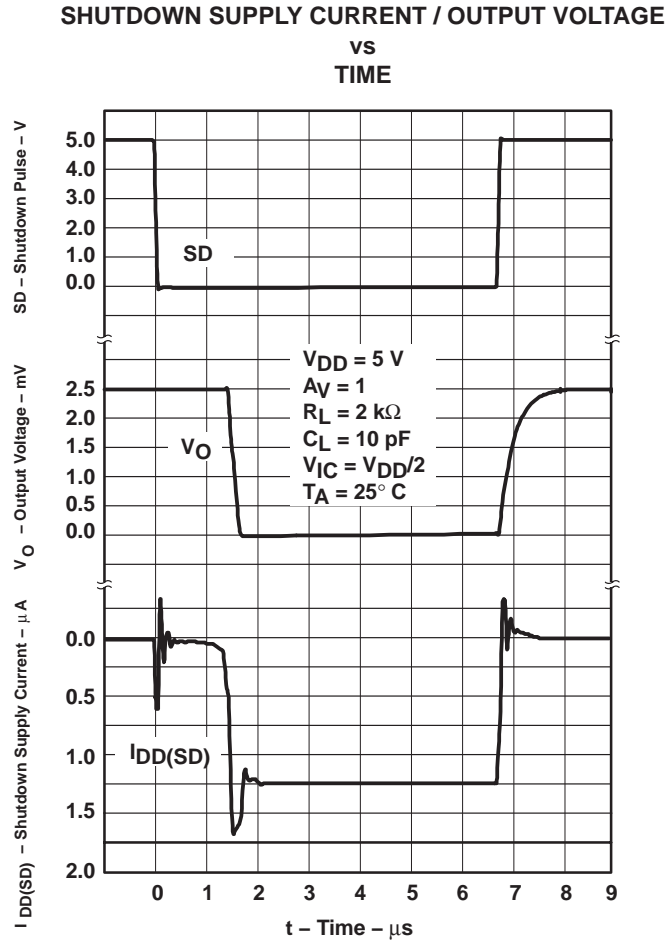
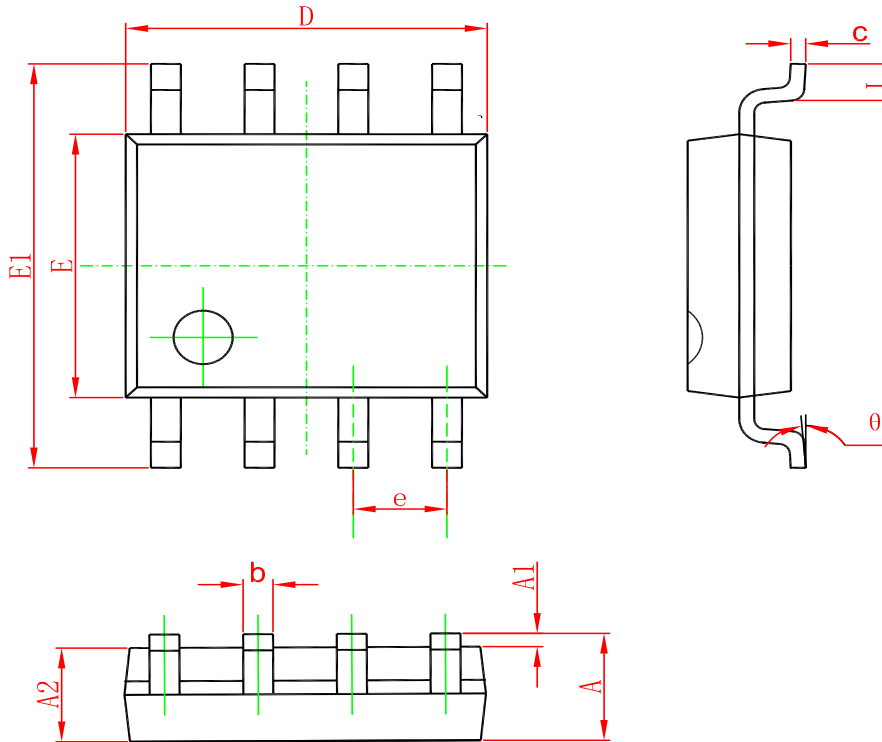

Figure 24

Package Dimension

SOP-8



Symbol	Dimensions In Millimeters		Dimensions In Inches	
	Min	Max	Min	Max
A	1.350	1.750	0.053	0.069
A1	0.100	0.250	0.004	0.010
A2	1.350	1.550	0.053	0.061
b	0.330	0.510	0.013	0.020
c	0.170	0.250	0.006	0.010
D	4.700	5.100	0.185	0.200
E	3.800	4.000	0.150	0.157
E1	5.800	6.200	0.228	0.244
e	1.270(BSC)		0.050(BSC)	
L	0.400	1.270	0.016	0.050
θ	0°	8°	0°	8°

SOP-14

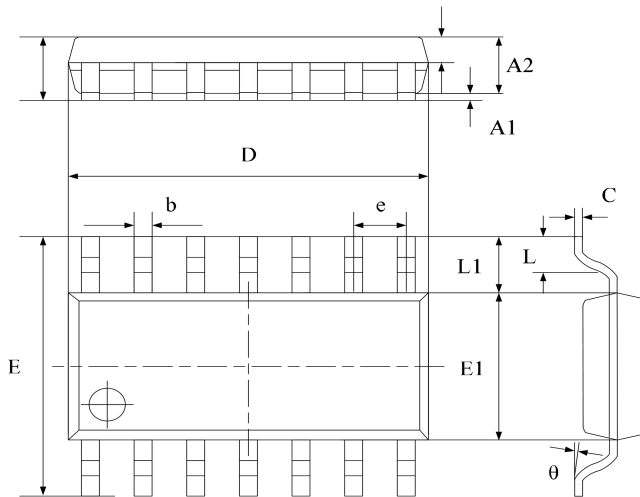

Symbol	Dimensions In Millimeters		Dimensions In Inches	
	Min	Max	Min	Max
A	1.450	1.850	0.059	0.076
A1	0.100	0.300	0.004	0.012
A2	1.350	1.550	0.055	0.063
A3	0.550	0.750	0.022	0.031
b	0.406typ.		0.017typ.	
C	0.203typ.		0.008typ.	
D	8.630	8.830	0.352	0.360
E	5.840	6.240	0.238	0.255
E1	3.850	4.050	0.157	0.165
e	1.270 typ.		0.050 typ.	
L1	1.040 ref.		0.041 ref.	
L	0.350	0.750	0.014	0.031
θ	2°	8°	2°	8°

TSSOP-14

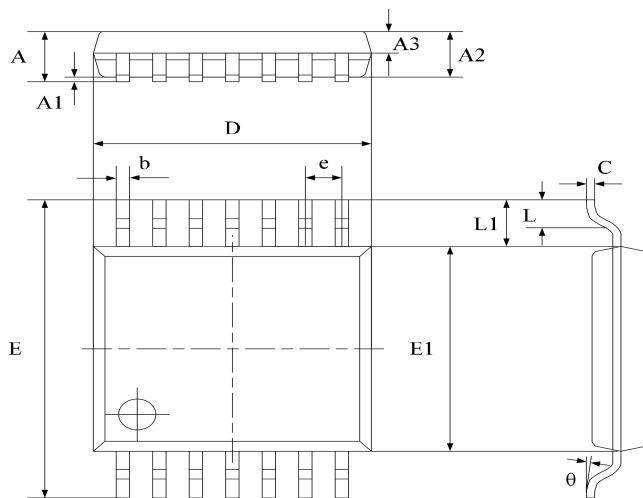

Symbol	Dimensions In Millimeters		Dimensions In Inches	
	Min	Max	Min	Max
A	-	1.200	-	0.0472
A1	0.050	0.150	0.002	0.006
A2	0.900	1.050	0.037	0.043
A3	0.390	0.490	0.016	0.020
b	0.200	0.290	0.008	0.012
C	0.130	0.180	0.005	0.007
D	4.860	5.060	0.198	0.207
E	6.200	6.600	0.253	0.269
E1	4.300	4.500	0.176	0.184
e	0.650 typ.		0.0256 typ.	
L1	1.000 ref.		0.0393 ref.	
L	0.450	0.750	0.018	0.031
θ	0°	8°	0°	8°

SOT23-5

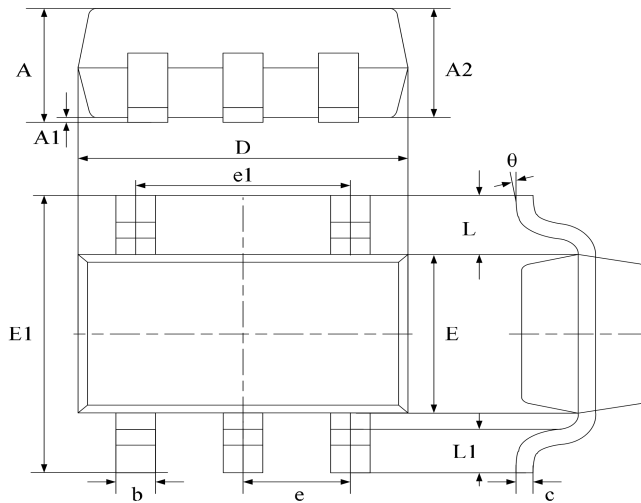

Symbol	Dimensions In Millimeters		Dimensions In Inches	
	Min	Max	Min	Max
A	1.040	1.350	0.042	0.055
A1	0.040	0.150	0.002	0.006
A2	1.000	1.200	0.041	0.049
b	0.380	0.480	0.015	0.020
c	0.110	0.210	0.004	0.009
D	2.720	3.120	0.111	0.127
E	1.400	1.800	0.057	0.073
E1	2.600	3.000	0.106	0.122
e	0.950 typ.		0.037 typ.	
e1	1.900 typ.		0.078 typ.	
L	0.700 ref.		0.028 ref.	
L1	0.300	0.600	0.012	0.024
θ	0°	8°	0°	8°

Ordering information

Order code	Package	Baseqty	Deliverymode	Marking
UMW TLV2631IDBVT	SOT23-5	3000	Tape and reel	VAZI U
UMW TLV2631IDBVR	SOT23-5	3000	Tape and reel	VAZI U
UMW TLV2631ID	SOP-8	2500	Tape and reel	TLV2631
UMW TLV2632IDR	SOP-8	2500	Tape and reel	2632I
UMW TLV2634ID	SOP-14	2500	Tape and reel	2634I
UMW TLV2634IPW	TSSOP-14	4000	Tape and reel	2634I
UMW TLV2634IPWR	TSSOP-14	4000	Tape and reel	2634I