

Description

The SES0711P4 is a high power 7V TVS diode, utilizing leading monolithic silicon technology to provide fast response time and low ESD clamping voltage, making this device an ideal solution for protecting voltage sensitive lines. Small size, high surge capability of SES0711P4 makes them ideal for use in applications such as cellular phones, LCD displays, USB, and multi media card interfaces.

Features

- Peak pulse power (5000W @ 8/20us)
- Working voltage: 7V
- Ultra low clamping voltage
- 3-pin leadless package
- RoHS Compliant

Mechanical Characteristics

- Package: DFN2020-3L (2.0X2.0X0.6mm)
- Lead Finish: Matte Tin
- Case Material: "Green" Molding Compound.
- UL Flammability Classification Rating 94V-0
- Moisture Sensitivity: Level 3 per J-STD-020

Applications

- Power Management
- Industrial Application
- Power Supply Protection

Dimensions & Symbol (Unit: mm Max)

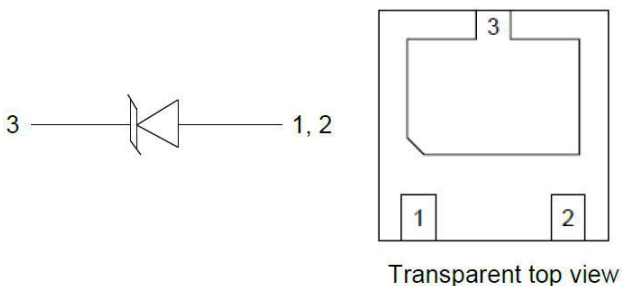

Circuit Diagram

Pin Schematic

Marking & Ordering information

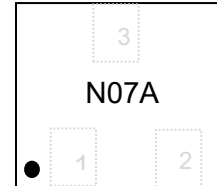

Remark: N07A or M07A is normal marking, any special marks please contact with local salltech sales.

Part Number	Packaging	Reel Size
SES0711P4	3000/Tape & Reel	7 inch

Part Number Information

SES0711P4--X (Notice1)



Notices1: X is Customer special code, if there any questions, please contact with local sales or email to sales@salltech.com

Absolute maximum ratings ($T_A=25^\circ\text{C}$, RH=45%-75%, unless otherwise noted)

Parameter	Symbol	Value	Unit
Peak Pulse Power ($t_p=8/20\mu\text{s}$ waveform)	P_{ppp}	5000	W
Peak Pulse Current (8/20 μs)	I_{pp}	275	A
ESD per IEC 61000-4-2 (Air)	V _{ESD}	± 30	kV
ESD per IEC 61000-4-2 (Contact)		± 30	
Operating Temperature Range	T_J	-55 to +125	$^\circ\text{C}$
Storage Temperature Range	T_{stg}	-55 to +150	$^\circ\text{C}$

Electrical characteristics ($T_A=25^\circ\text{C}$)

Parameter	Symbol	Min	Typ	Max	Unit	Test Condition
Reverse Working Voltage	V_{RWM}			7	V	
Breakdown Voltage	V_{BR}	7.5			V	$I_T = 1\text{mA}$
Reverse Leakage Current	I_R			1.0	μA	$V_{RWM} = 7\text{V}$
Clamping Voltage	V_C			10	V	$I_{PP} = 10\text{A}$ (8 x 20 μs pulse)
Clamping Voltage	V_C			22	V	$I_{PP} = 275\text{A}$ (8 x 20 μs pulse)
Junction Capacitance	C_J			1000	pF	$V_R = 0\text{V}$, $f = 1\text{MHz}$

Typical Performance Characteristics ($T_A=25^\circ\text{C}$ unless otherwise Specified)

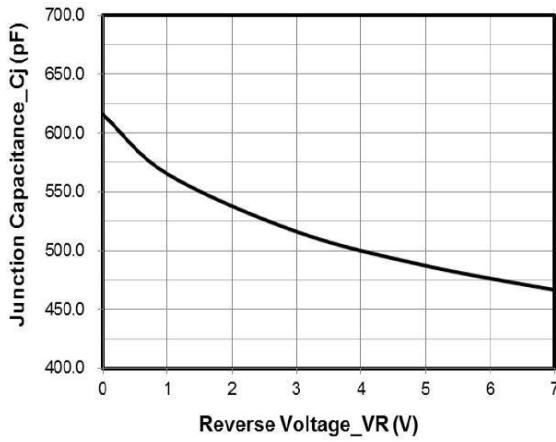

Junction Capacitance vs. Reverse Voltage

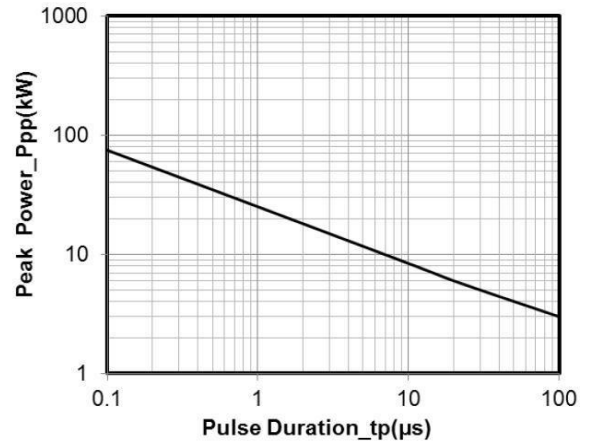

Peak Pulse Power vs. Pulse Time

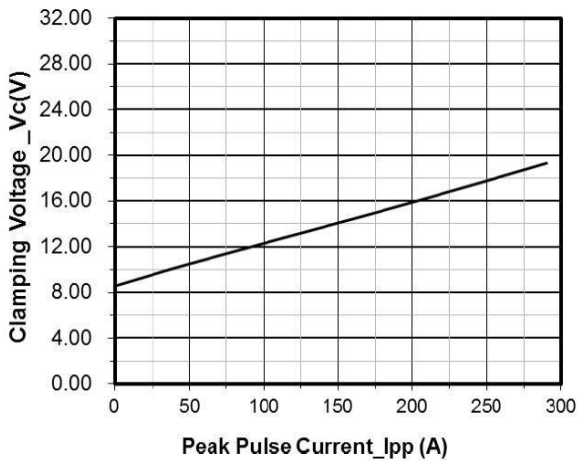

Clamping Voltage vs. Peak Pulse Current

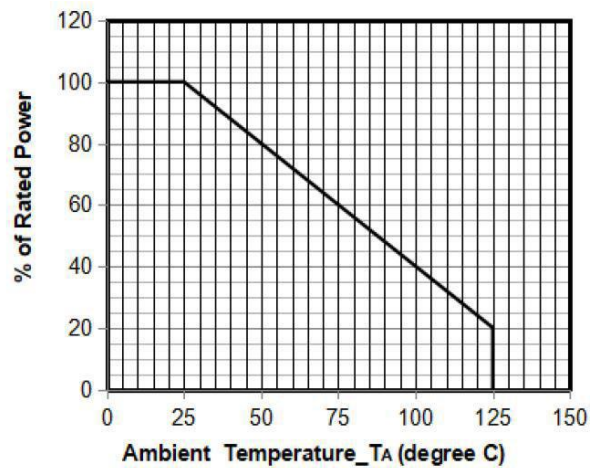

Power Derating Curve

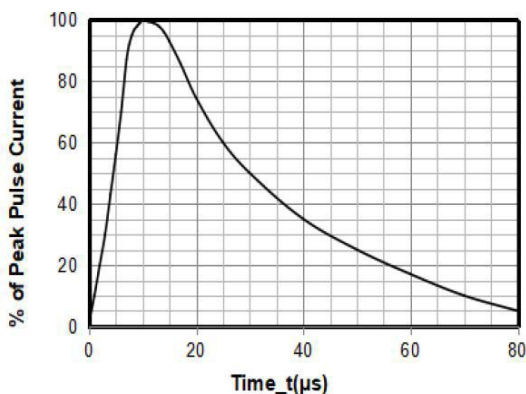

8 X 20μs Pulse Waveform

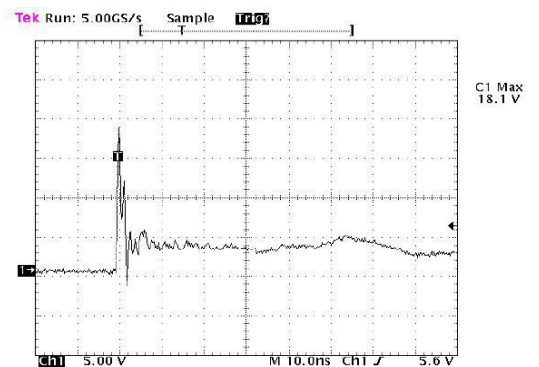

Note: Data is taken with a 10x attenuator

ESD Clamping Voltage

8 kV Contact per IEC61000-4-2

Soldering Parameters

Reflow Condition		Pb-Free assembly (see as below)
Pre Heat	-Temperature Min ($T_{s(min)}$)	+150°C
	-Temperature Max($T_{s(max)}$)	+200°C
	-Time (Min to Max) (t_s)	60-180 secs.
Average ramp up rate (Liquid us Temp (T_L) to peak)		3°C/sec. Max
$T_{s(max)}$ to T_L - Ramp-up Rate		3°C/sec. Max
Reflow	-Temperature(T_L) (Liquid us)	+217°C
	-Temperature(t_L)	60-150 secs.
Peak Temp (T_p)		+260(+0/-5)°C
Time within 5°C of actual Peak Temp (t_p)		30 secs. Max
Ramp-down Rate		6°C/sec. Max
Time 25°C to Peak Temp (T_P)		8 min. Max
Do not exceed		+260°C

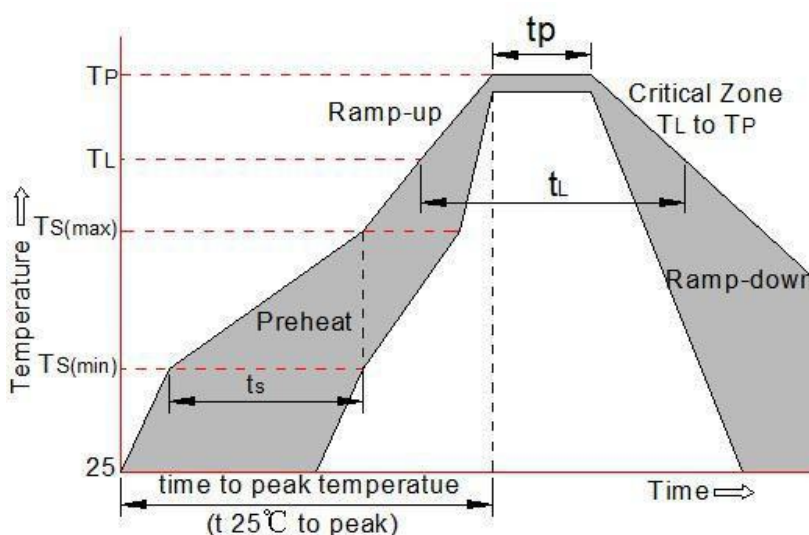

Package Mechanical Data

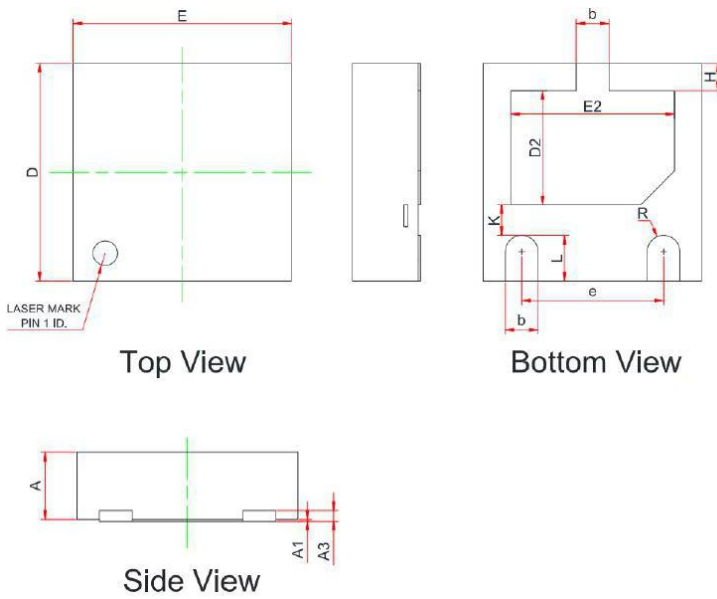

SYM	DIMENSIONS		
	MILLIMETERS		
	MIN	NOM	MAX
A	0.55	0.60	0.65
A1	0.00	0.02	0.05
A3	0.10REF		
b	0.25	--	0.35
D	1.90	--	2.10
E	1.90	--	2.10
D2	0.95	--	1.15
E2	1.40	--	1.60
e	1.20		1.40
H	0.20	--	0.30
K	0.20		0.40
L	0.35	--	0.45
R	0.13	--	--

Suggested Land Pattern for PCB

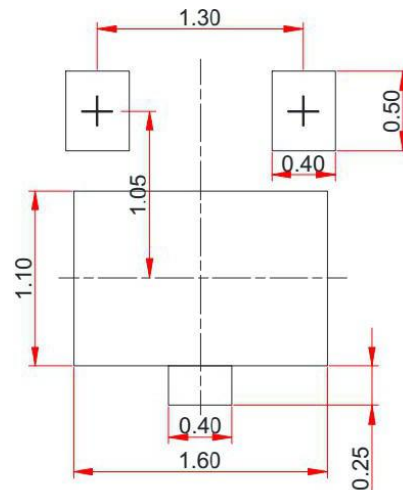

Tape and Reel Information

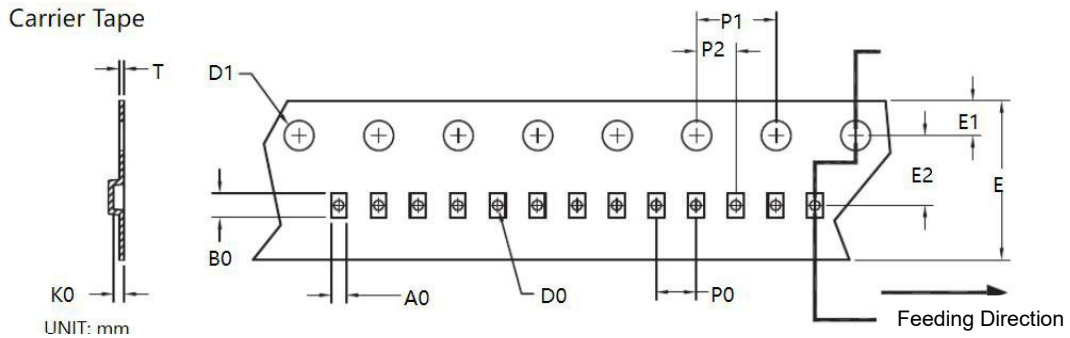

Dimensions are in millimeter

Package type	A0	B0	D0	P0	P1	P2	P	E	E1	E2	D1	K0	T	Q'ty
DFN2020-3L	2.1	2.1	1.0	2.0	4.0	2.0	4.0	8.0	1.75	3.50	1.5	0.60	0.25	3000

DFN2020 Traller, Leader and Reel

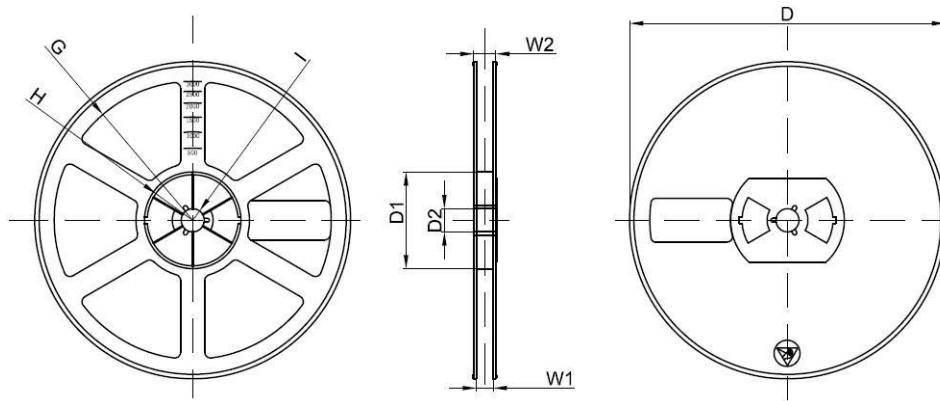
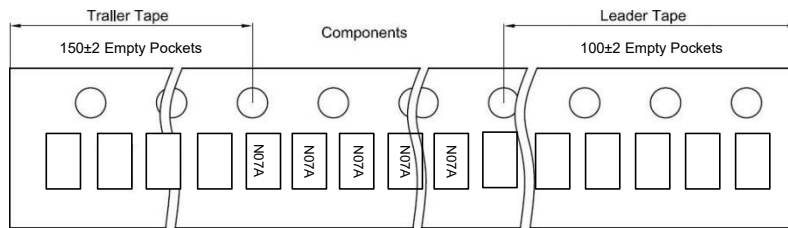

Dimensions are in millimeter

Reel Option	D	D1	D2	G	H	I	W1	W2
7"D1a	178	54.40	13.00	78	25.60	6.50	14.40	12.30

Contact Information

JIANGXI Salltech Microelectronics Technology Co.,Ltd.

N0.699 Huangtang East Street,Ganjiang New District, Nanchang city,Jiangxi province

Tel: +86-791-83962891

Fax: +86-791-83962890

Revision History

Release Date	Revision	Comments
2017-8-17	A	New Release
2021-11-13	B	Add Body Mark, Tape and Reel information