



为您的产品保驾护航

PRODUCT DATASHEET

Electro-Static Discharge

JEN0603-5V-ULC ESD

Features

- Ultra small package: 0.6x0.3x0.3mm(DFN0603)
- Ultra low capacitance: 0.3pF typical
- Ultra low leakage: nA level
- Operating voltage: 5V
- Low clamping voltage
- 2-pin leadless package
- Complies with following standards:
 - IEC 61000-4-2 (ESD) immunity test
Air discharge: $\pm 25\text{kV}$
Contact discharge: $\pm 22\text{kV}$
 - IEC61000-4-5 (Lightning) 4A (8/20 μs)
- RoHS compliant

Pin Description



Applications

- Cellular Handsets and Accessories
- Display Ports
- MDDI Ports
- USB Ports
- Digital Visual Interface (DVI)
- PCI Express and Serial SATA Ports

Schematic Diagram

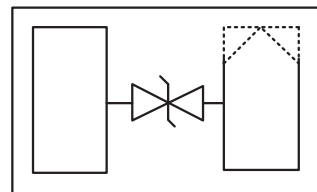

Limiting Values($T_A = 25\text{ }^\circ\text{C}$, unless otherwise specified)

Symbol	Parameter	Conditions	Value	Unit
V _{ESD}	Electrostatic Discharge Voltage	IEC 61000-4-2;Contact Discharge	± 22	kV
		IEC 61000-4-2;Air Discharge	± 25	kV
P _{Pk}	Peak Pulse Power	t _P =8/20 μs	100	W
I _{PP}	Peak Pulse Current	t _P =8/20 μs	4	A
T _J	Operating Temperature Range	-	-55 to +125	$^\circ\text{C}$
T _{stg}	Storage Temperature Range	-	-55 to +150	$^\circ\text{C}$

Electrical Characteristics($T_A = 25\text{ }^\circ\text{C}$, unless otherwise specified)

Symbol	Parameter	Conditions	Min	Typ.	Max	Unit
V _{RWM}	Reverse Working Voltage	T _A =25 $^\circ\text{C}$	-	-	5.0	V
V _{BR}	Breakdown Voltage	I _T =1mA	6.5	-	9.5	V
I _R	Reverse Leakage Current	V _{RWM} =5V	-	0.02	0.2	μA
V _C	Clamping Voltage	I _{PP} =1A(8x20 μs pulse)	-	-	12	V
V _C	Clamping Voltage	I _{PP} =4A(8x20 μs pulse)	-	-	25	V
C _J	Junction Capacitance	V _R =0V,f=1 MHz	-	0.3	0.5	pF

Typical Characteristics

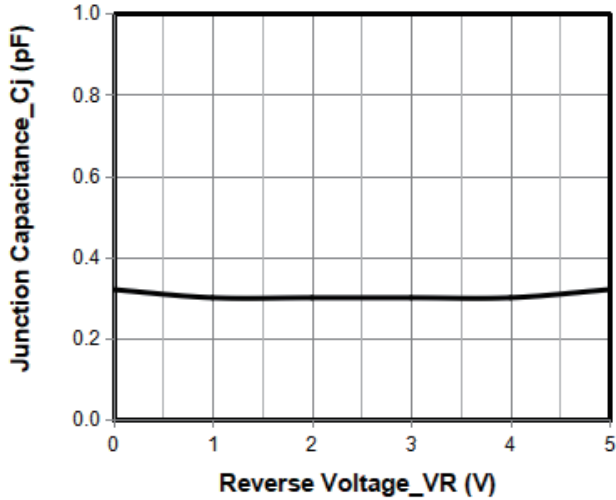

Junction Capacitance vs. Reverse Voltage

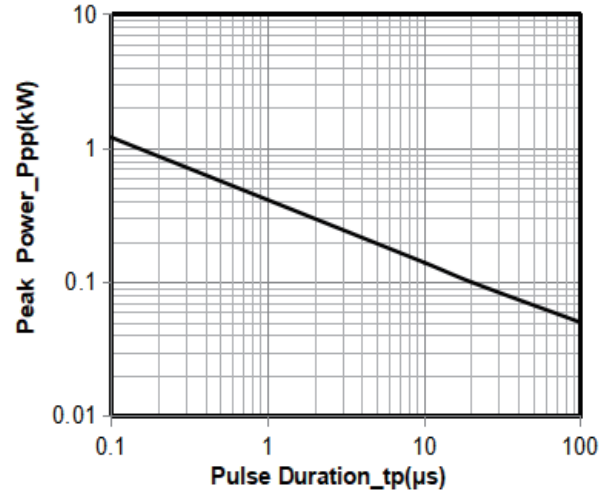

Peak Pulse Power vs. Pulse Time

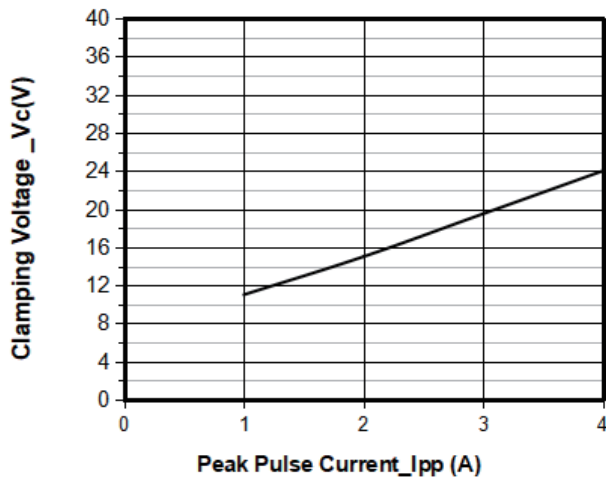

Clamping Voltage vs. Peak Pulse Current (tp = 8/20 μs)

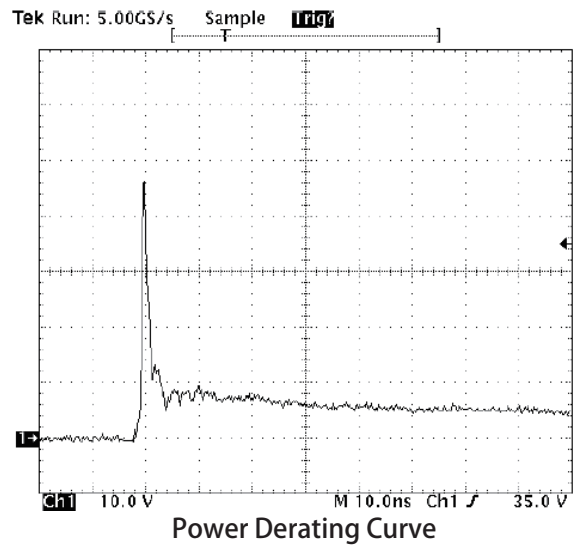

Power Derating Curve

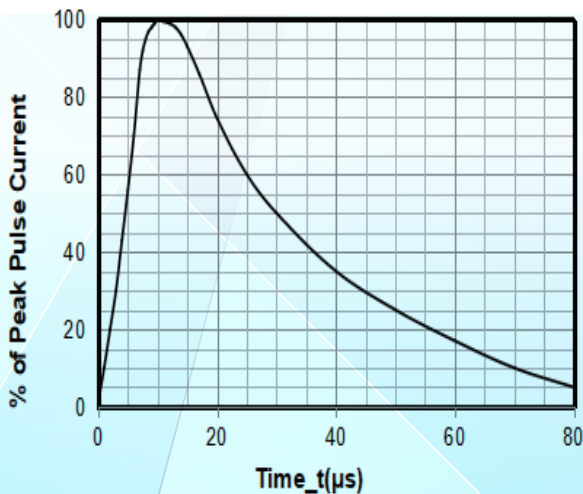

8 X 20 μs Pulse Waveform

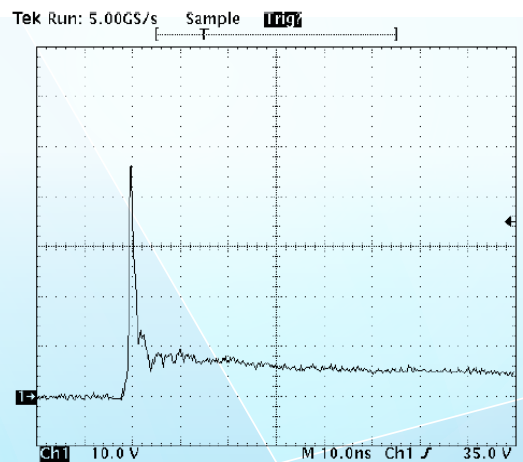

ESD Clamping Voltage
8 kV Contact per IEC61000-4-2

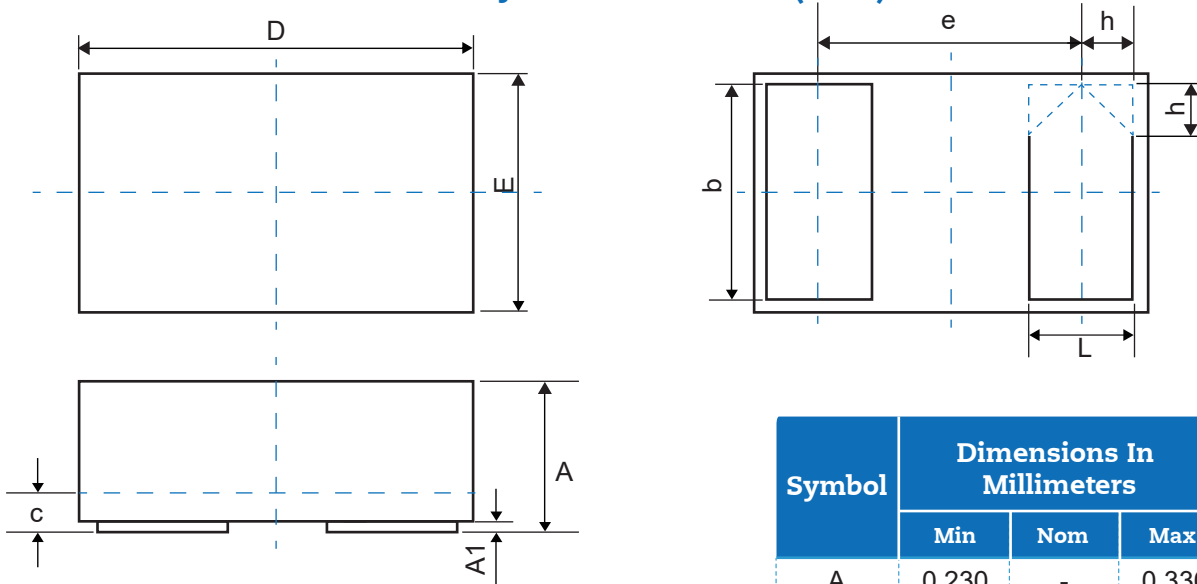
Physical Dimensions(mm.)

Symbol	Dimensions In Millimeters		
	Min	Nom	Max
A	0.230	-	0.330
A1	0.000	0.020	0.050
b	0.215	0.245	0.275
c	0.120	0.150	0.180
D	0.550	0.600	0.650
e	0.355 BSC		
E	0.250	0.300	0.350
L	0.160	0.190	0.220
h	0.079 BSC		

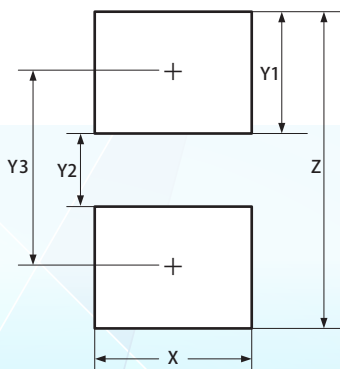
Suggested Land Pattern

Symbol	Dimensions Millimeters	
	Min.	Max.
X	0.30	0.012
Y1	0.25	0.010
Y2	0.15	0.006
Y3	0.40	0.016
Z	0.65	0.026

Packaging Quantity

Part Number	Size(mm)	Delivery Form	Delivery Quantity
JEN0603-5V-ULC	0.6x0.3x0.3	7"T&R	10,000

Soldering Parameters

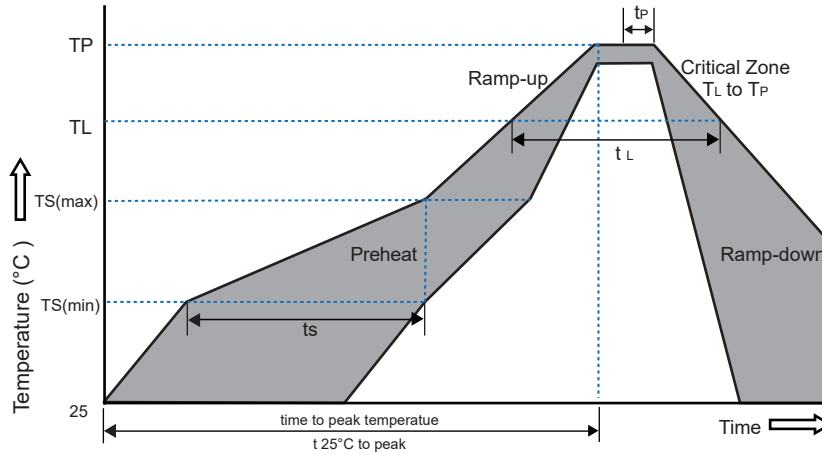

Reflow Condition		Pb-Free Assembly
Pre-heat	-Temperature Min($T_{s(min)}$)	+150°C
	-Temperature Max($T_{s(max)}$)	+200°C
	-Time(Min to Max)(t_s)	60~180 secs.
Average ramp up rate (Liquid us Temp(T_L) to peak)		3°C/sec. Max
Ts(max) to T_L - Ramp-up Rate		3°C/sec. Max
Reflow	-Temperature(T_L)(Liquid us)	+217°C
	-Temperature (t_L)	60~150 secs.
Peak Temp (T_P)		+260(+0/-5)°C
Time within 5°C of actual Peak Temp (t_p)		30 secs. Max
Ramp-down Rate		6°C/sec. Max
xTime 25°C to Peak Temp (TP)		8 min. Max
Do not exceed		+260°C

Part Number System

JE N0603 - 5V - UL C

