

R41B, THB GradellIB, Class X1/Y2, 350 VAC, 125°C (Automotive Grade)

Overview

The R41B is constructed of metallized polypropylene film, encapsulated with self-extinguishing resin, in a box of material meeting the requirements of UL 94 V-0.

Automotive Grade devices meet the demanding Automotive Electronics Council's AEC-Q200 qualification requirements.

Applications

For use in electromagnetic interference (EMI) suppression filter in "line-to-ground" and "across-the-line" applications, requiring Y2/X1 safety classification. Suitable for use in situations where failure of the capacitor could lead to danger of electric shock.

Benefits

- Approvals: ENEC, UL, cUL, CQC
- Class Y2/X1 (IEC 60384-14)
- THB Grade IIIB: 85°C, 85% RH, 1,000 hours at 350 V URAC acc. to IEC 60384-14
- Halogen-Free (black case) upon request
- Rated voltage: 350 VAC 50/60 Hz
- Capacitance range: 0.0022 – 1.2 µF
- Lead spacing: 10 – 37.5 mm
- Capacitance tolerance: ±20%, ±10%
- Climatic category 40/125/56, IEC 60068-1
- Tape and reel in accordance with IEC 60286-2
- RoHS compliant and lead-free terminations
- Operating temperature range of -40°C to +125°C
- Self-healing properties
- Automotive (AEC-Q200) grade



Part Number System

R41	B	I	2330	00	T0	M	V106
Series	Rated Voltage (VAC)	Lead Spacing (mm)	Capacitance Code (pF)	Packaging	Internal Use	Capacitance Tolerance	Optional C-Spec
Y2, Metallized Polypropylene	B = 350	F = 10.0 I = 15.0 N = 22.5 R = 27.5 W = 37.5	The last three digits represent significant figures. The first digit specifies number of zeros to be added.	See Ordering Options Table	T0 T1	K = ±10% M = ±20%	Blank = Standard, grey case V106 = Halogen Free Version, black case

Ordering Options Table

Lead Spacing Nominal (mm)	Type of Leads and Packaging	Lead Length (mm)	Lead and Packaging Code
10 15 22.5	Standard Lead and Packaging Options		
	Bulk (Bag) – Short Leads	4 +2/-0	00
	Ammo Pack	H ₀ = 18.5 ±0.5	DQ
	Other Lead and Packaging Options		
	Tape & Reel (Large Reel)	H ₀ = 18.5 ±0.5	CK
	Tape & Reel (Standard Reel)	H ₀ = 18.5 ±0.5	GY
	Bulk (Bag) ² – Short Leads	3.5 +0.5/-0	JB
	Bulk (Bag) ² – Short Leads	4.0 +0.5/-0	JE
	Bulk (Bag) ² – Short Leads	3.2 +0.3/-0.2	JH
	Bulk (Bag) – Long Leads	18 ±1	JM
	Bulk (Bag) – Long Leads	30 +5/-0	40
Bulk (Bag) – Long Leads	25 +2/-1	50	
27.5	Standard Lead and Packaging Options		
	Bulk (Tray) – Short Leads	4 +2/-0	00
	Tape & Reel (Large Reel)	H ₀ = 18.5 ±0.5	CK ¹
	Other Lead and Packaging Options		
	Bulk (Tray) – Long Leads	30 +5/-0	40
Bulk (Tray) – Long Leads	25 +2/-1	50	
37.5	Standard Lead and Packaging Options		
	Bulk (Tray) ³ – Short Leads	4 +2/-0	00
	Other Lead and Packaging Options		
	Bulk (Tray) ³ – Long Leads	30 +5/-0	40
Bulk (Tray) ³ – Long Leads	25 +2/-1	50	

¹ Not for all sizes, see "Packaging Quantities" table

² For lead spacing 22.5 case sizes ≥ 8.5*17*26.5 the parts are packed in a Pizza box 335*320*34 mm

³ For standard (no C-Spec); with C-Spec "V106" packaging is in Pizza Pack

Dimensions – Millimeters

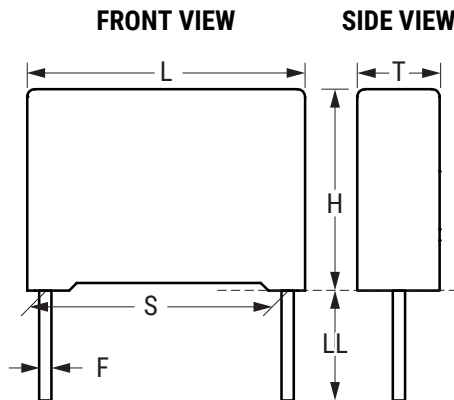

S		T		H		L		F	
Nominal	Tolerance	Nominal	Tolerance	Nominal	Tolerance	Nominal	Tolerance	Nominal	Tolerance
10.0	±0.4	4.0	+0.2/-0.5	9.0	+0.1/-0.5	13.0	+0.3/-0.5	0.6	±0.05
10.0	±0.4	5.0	+0.2/-0.5	11.0	+0.1/-0.5	13.0	+0.3/-0.5	0.6	±0.05
10.0	±0.4	6.0	+0.2/-0.5	12.0	+0.1/-0.5	13.0	+0.3/-0.5	0.6	±0.05
15.0	±0.4	5.0	+0.2/-0.5	11.0	+0.1/-0.5	18.0	+0.3/-0.5	0.6	±0.05
15.0	±0.4	6.0	+0.2/-0.5	12.0	+0.1/-0.5	18.0	+0.3/-0.5	0.6	±0.05
15.0	±0.4	7.5	+0.2/-0.5	13.5	+0.1/-0.5	18.0	+0.3/-0.5	0.6	±0.05
15.0	±0.4	8.5	+0.2/-0.5	14.5	+0.1/-0.5	18.0	+0.3/-0.5	0.6	±0.05
15.0	±0.4	10.0	+0.2/-0.5	16.0	+0.1/-0.5	18.0	+0.3/-0.5	0.8	±0.05
15.0	±0.4	11.0	+0.2/-0.5	19.0	+0.1/-0.5	18.0	+0.3/-0.5	0.8	±0.05
22.5	±0.4	6.0	+0.2/-0.5	15.0	+0.1/-0.5	26.5	+0.3/-0.5	0.8	±0.05
22.5	±0.4	7.0	+0.2/-0.5	16.0	+0.1/-0.5	26.5	+0.3/-0.5	0.8	±0.05
22.5	±0.4	8.5	+0.2/-0.5	17.0	+0.1/-0.5	26.5	+0.3/-0.5	0.8	±0.05
22.5	±0.4	10.0	+0.2/-0.5	18.5	+0.1/-0.5	26.5	+0.3/-0.5	0.8	±0.05
22.5	±0.4	11.0	+0.2/-0.5	20.0	+0.1/-0.5	26.5	+0.3/-0.5	0.8	±0.05
22.5	±0.4	13.0	+0.2/-0.5	22.0	+0.1/-0.5	26.5	+0.3/-0.5	0.8	±0.05
27.5	±0.4	13.0	+0.2/-0.7	22.0	+0.1/-0.7	32.0	+0.3/-0.7	0.8	±0.05
27.5	±0.4	14.0	+0.2/-0.7	28.0	+0.1/-0.7	32.0	+0.3/-0.7	0.8	±0.05
27.5	±0.4	18.0	+0.2/-0.7	33.0	+0.1/-0.7	32.0	+0.3/-0.7	0.8	±0.05
37.5	±0.4	13.0	+0.2/-0.7	24.0	+0.1/-0.7	41.5	+0.3/-0.7	1.0	±0.05
37.5	±0.4	16.0	+0.2/-0.7	28.5	+0.1/-0.7	41.5	+0.3/-0.7	1.0	±0.05
37.5	±0.4	20.0	+0.2/-0.7	40.0	+0.1/-0.7	41.5	+0.3/-0.7	1.0	±0.05

Note: See Ordering Options Table for lead length (LL/H₀) options.

Dimensions – Millimeters for parts with C-Spec "V106" (Halogen-Free parts)

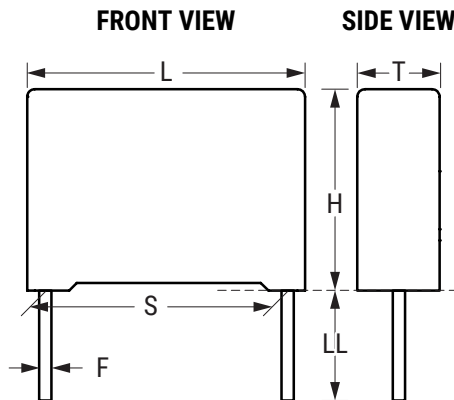

S		T		H		L		F	
Nominal	Tolerance	Nominal	Tolerance	Nominal	Tolerance	Nominal	Tolerance	Nominal	Tolerance
10.0	±0.4	4.0	+0.3/-0.5	9.0	+0.3/-0.5	13.0	+0.5/-0.5	0.6	±0.05
10.0	±0.4	5.0	+0.3/-0.5	11.0	+0.3/-0.5	13.0	+0.5/-0.5	0.6	±0.05
10.0	±0.4	6.0	+0.3/-0.5	12.0	+0.3/-0.5	13.0	+0.5/-0.5	0.6	±0.05
15.0	±0.4	5.0	+0.3/-0.5	11.0	+0.3/-0.5	18.0	+0.5/-0.5	0.6	±0.05
15.0	±0.4	6.0	+0.3/-0.5	12.0	+0.3/-0.5	18.0	+0.5/-0.5	0.6	±0.05
15.0	±0.4	7.5	+0.3/-0.5	13.5	+0.3/-0.5	18.0	+0.5/-0.5	0.6	±0.05
15.0	±0.4	8.5	+0.3/-0.5	14.5	+0.3/-0.5	18.0	+0.5/-0.5	0.6	±0.05
15.0	±0.4	10.0	+0.3/-0.5	16.0	+0.3/-0.5	18.0	+0.5/-0.5	0.8	±0.05
15.0	±0.4	11.0	+0.3/-0.5	19.0	+0.3/-0.5	18.0	+0.5/-0.5	0.8	±0.05
22.5	±0.4	6.0	+0.3/-0.5	15.0	+0.3/-0.5	26.5	+0.5/-0.5	0.8	±0.05
22.5	±0.4	7.0	+0.3/-0.5	16.0	+0.3/-0.5	26.5	+0.5/-0.5	0.8	±0.05
22.5	±0.4	8.5	+0.3/-0.5	17.0	+0.3/-0.5	26.5	+0.5/-0.5	0.8	±0.05
22.5	±0.4	10.0	+0.3/-0.5	18.5	+0.3/-0.5	26.5	+0.5/-0.5	0.8	±0.05
22.5	±0.4	11.0	+0.3/-0.5	20.0	+0.3/-0.5	26.5	+0.5/-0.5	0.8	±0.05
22.5	±0.4	13.0	+0.3/-0.5	22.0	+0.3/-0.5	26.5	+0.5/-0.5	0.8	±0.05
27.5	±0.4	13.0	+0.3/-0.7	22.0	+0.3/-0.7	32.0	+0.5/-0.7	0.8	±0.05
27.5	±0.4	14.0	+0.3/-0.7	28.0	+0.3/-0.7	32.0	+0.5/-0.7	0.8	±0.05
27.5	±0.4	18.0	+0.3/-0.7	33.0	+0.3/-0.7	32.0	+0.5/-0.7	0.8	±0.05
37.5	±0.4	13.0	+0.3/-0.7	24.0	+0.3/-0.7	42.0	+0.5/-0.7	1.0	±0.05
37.5	±0.4	16.0	+0.3/-0.7	28.5	+0.3/-0.7	42.0	+0.5/-0.7	1.0	±0.05
37.5	±0.4	20.0	+0.3/-0.7	40.0	+0.3/-0.7	42.0	+0.5/-0.7	1.0	±0.05

Note: See Ordering Options Table for lead length (LL/H₀) options.

Performance Characteristics

Dielectric	Polypropylene film			
Plates	Metal layer deposited by evaporation under vacuum			
Winding	Non-inductive type			
Leads	Tinned wire			
Protection	Plastic case, thermosetting resin filled. Box material is solvent resistant and flame retardant according to UL 94			
Related Documents	IEC 60384-14, EN 60384-14			
Rated Voltage (V_R)	350 VAC (50/60 Hz)/1,500 VDC			
Capacitance Range	0.0022 – 1.2 μ F			
Capacitance Values	E6 series (IEC 60063)			
Capacitance Tolerance	\pm 10%, \pm 20%			
Temperature Range	-40°C to +125°C			
Climatic Category	40/125/56 IEC 60068-1			
Reliability	Operational life 100,000 hours at 85°C; 2,000 hours at 125°C			
Storage Conditions	Storage time: \leq 24 months from the date marked on the label package			
	Average relative humidity per year \leq 70%			
	RH \leq 85% for 30 days randomly distributed throughout the year			
	Dew is absent			
Approvals	ENEC, UL, cUL, CQC			
Dissipation Factor ($\tan\delta$) at 1 kHz	Maximum Values at +25°C \pm 5°C			
	pitch = 10 mm	pitch \geq 15 mm		
	0.8%	0.3% (typical: 0.2%)		
Hi-Pot Test	Terminal To Terminal	4.0k VDC (Type test 60 seconds, each ramp 5 seconds)		
	Terminal To Case	4.0k VDC (Type test 60 seconds, each ramp 5 seconds)		
Insulation Resistance	Measured at +25°C \pm 5°C			
	Minimum Values Between Terminals			
	Voltage Charge	Voltage Charge Time	$C \leq 0.33 \mu$ F	$C > 0.33 \mu$ F
	100 VDC	1 minute	$\geq 1 \cdot 10^5 \text{ M}\Omega$ ($\geq 5 \cdot 10^5 \text{ M}\Omega$)*	$\geq 30,000 \text{ M}\Omega \cdot \mu$ F ($\geq 150,000 \text{ M}\Omega \cdot \mu$ F)*

* Typical value

Performance Characteristics cont.

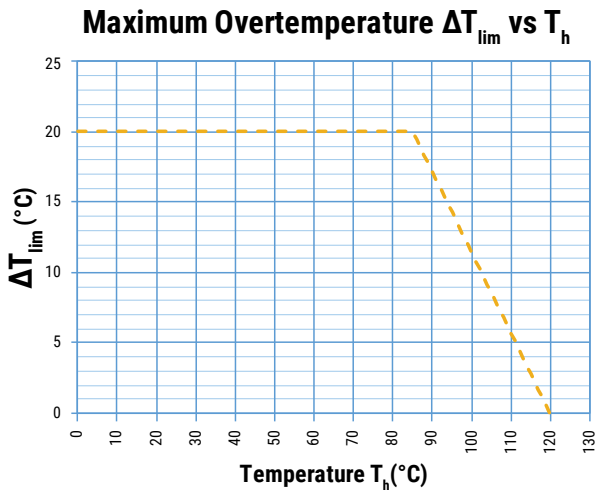
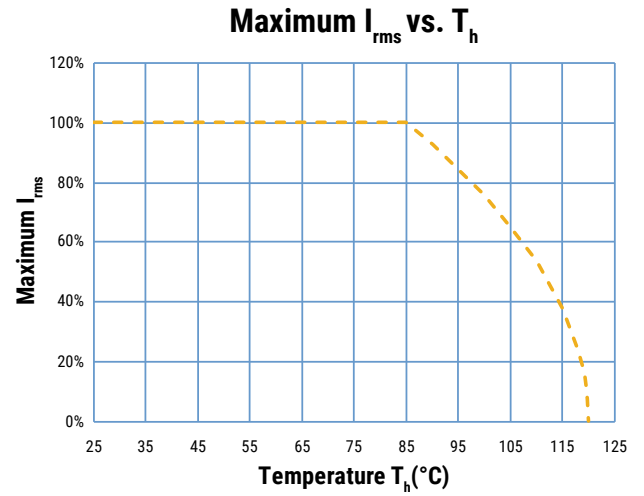
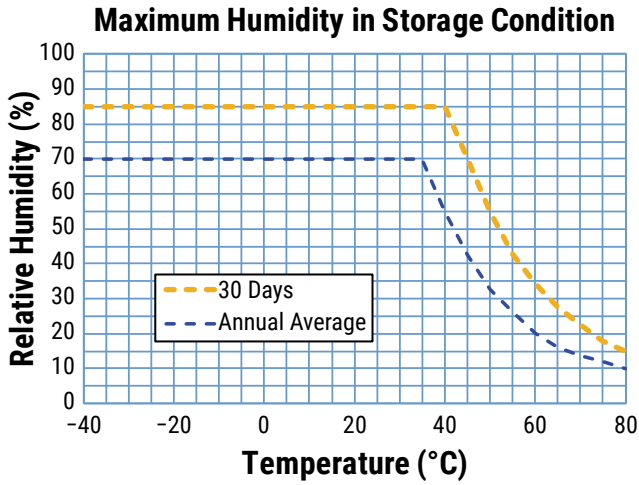

T_h is the maximum ambient temperature surrounding the capacitor or hottest contact point (e.g. tracks), whichever is higher, in the worst operation conditions in °C.

Maximum Voltage (V_{rms}) Versus Frequency (Sinusoidal Waveform/ $Th \leq 85^\circ C$)

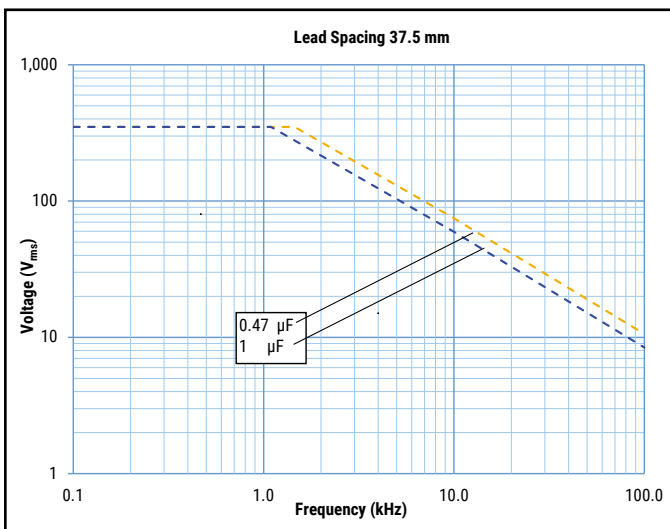
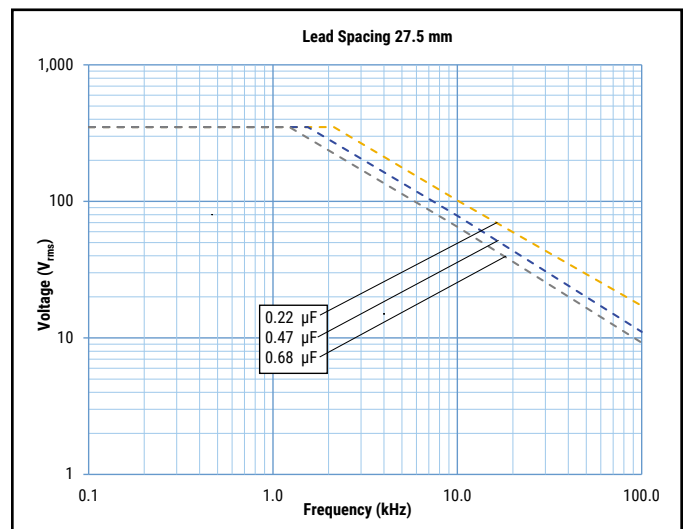
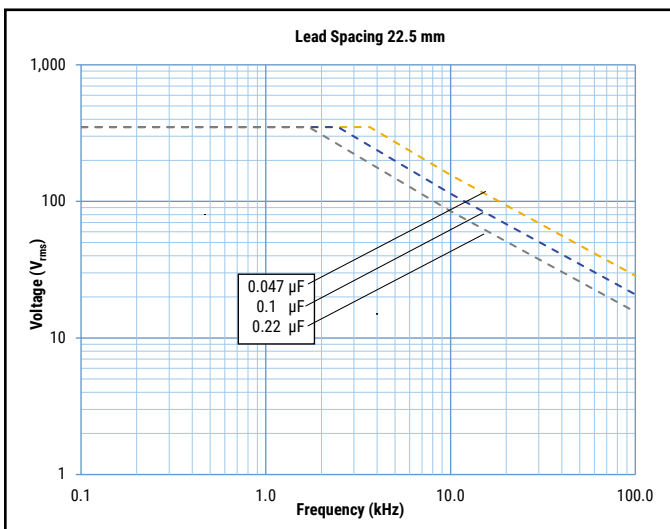
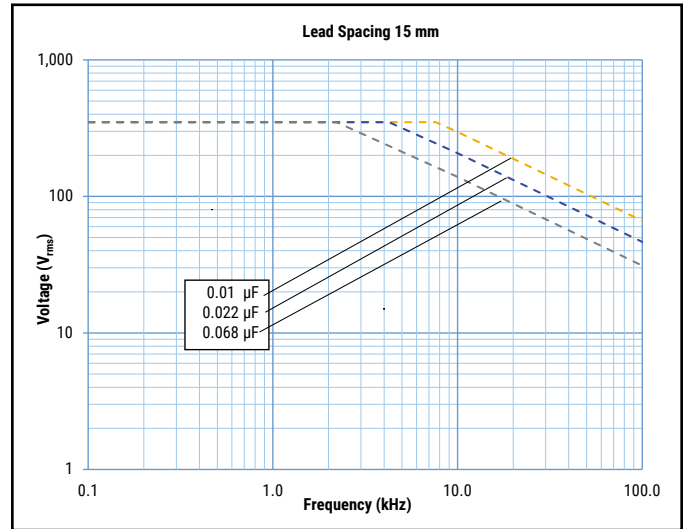
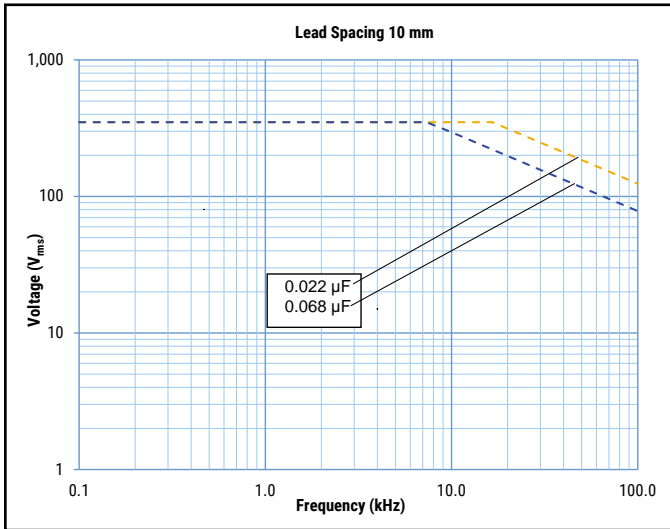

Maximum Current (I_{rms}) Versus Frequency (Sinusoidal Waveform/ $Th \leq 85^\circ C$)

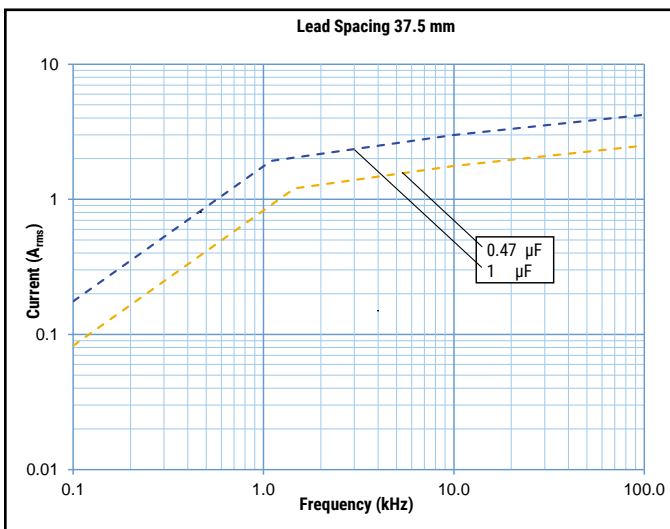
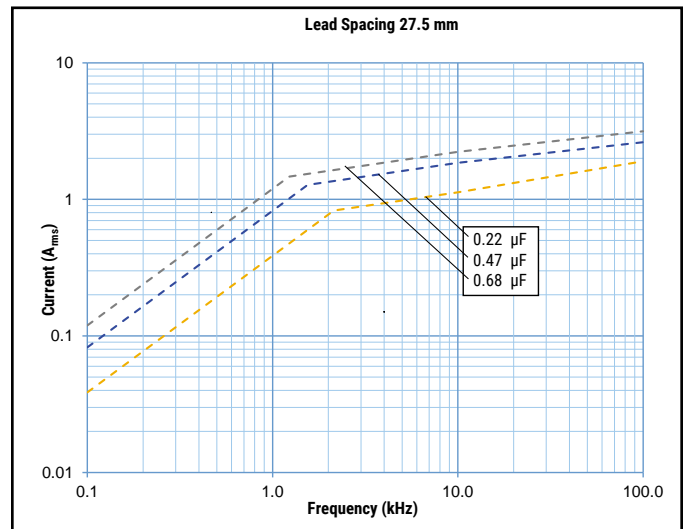
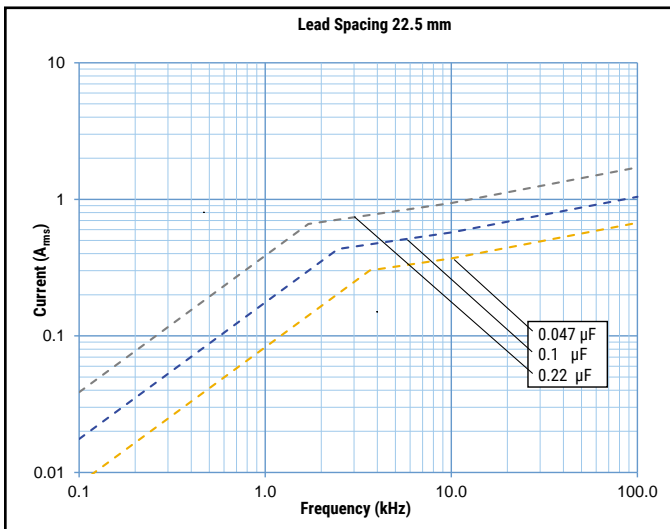
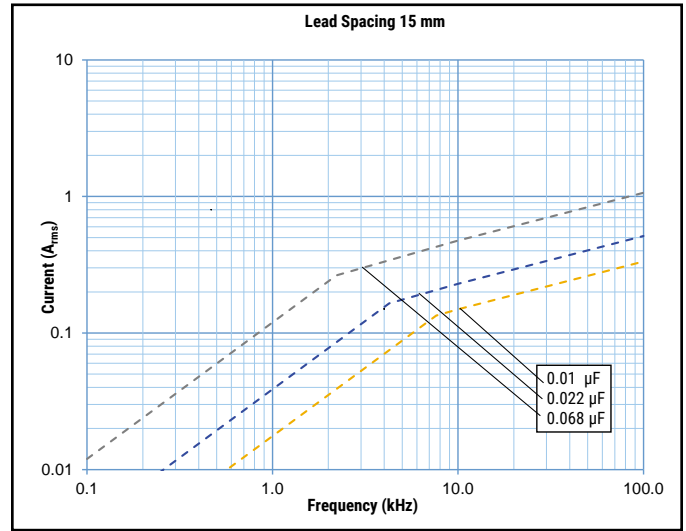
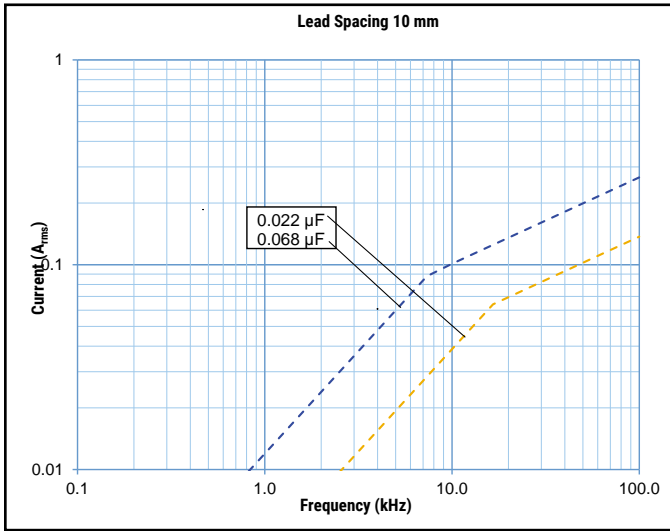

Qualification

Automotive grade products meet or exceed the requirements outlined by the Automotive Electronics Council. Details regarding test methods and conditions are referenced in document AEC-Q200, Stress Test Qualification for Passive Components. For additional information regarding the Automotive Electronics Council and AEC-Q200, please visit their website at www.aecouncil.com.

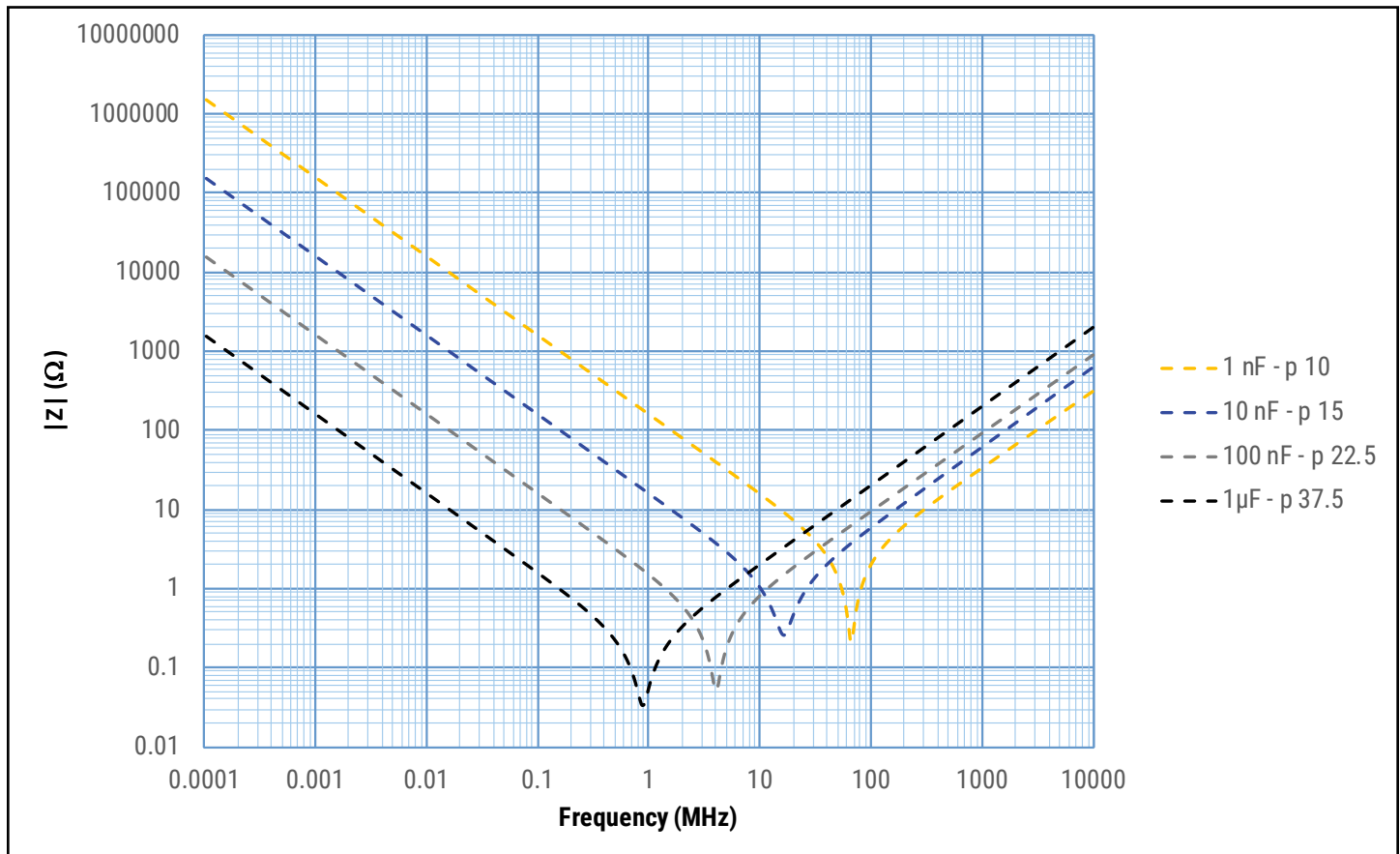

Impedance Graph



Environmental Test Data

Test	IEC Publication	Procedure
Endurance	IEC 60384-14	1.7 x V _R VAC 50 Hz, once every hour increase to 1,000 VAC for 0.1 second, 1,000 hours at upper rated temperature
Vibration	IEC 60068-2-6 Test Fc	3 directions at 2 hours each 10 – 55 Hz at 0.75 mm or 98m/s ²
Bump	IEC 60068-2-29 Test Eb	1,000 bumps at 390 m/s ²
Change of Temperature	IEC 60068-2-14 Test Na	Upper and lower rated temperature 5 cycles
Active Flammability	IEC 60384-14	V _R +20 surge pulses at 5 kV (pulse every 5 seconds)
Passive Flammability	IEC 60384-14	IEC 60384-1, IEC 60695-11-5 Needle Flame Test
Damp Heat Steady State	IEC 60068-2-78 Test Cab	+40°C and 93% RH, 56 days
THB test1		65°C, 93% RH and 1,000 VDC, 1,600 hours Capacitance change ($\Delta C/C$): $\leq 10\%$ Dissipation factor change ($\Delta \tan\delta$): $\leq 150 * 10^{-4}$ (at 1 kHz for Cap > 1 μ F) Dissipation factor change ($\Delta \tan\delta$): $\leq 240 * 10^{-4}$ (at 10 kHz for Cap $\leq 1 \mu$ F) IR $\geq 50\%$ of initial limit or minimum 200 M Ω
THB test2		85°C, 85% RH and 1,500 VDC, 1,000 hours Capacitance change ($\Delta C/C$): $\leq 10\%$ Dissipation factor change ($\Delta \tan\delta$): $\leq 150 * 10^{-4}$ (at 1 kHz for Cap > 1 μ F) Dissipation factor change ($\Delta \tan\delta$): $\leq 240 * 10^{-4}$ (at 10 kHz for Cap $\leq 1 \mu$ F) IR $\geq 50\%$ of initial limit or minimum 200 M Ω
THB test3		85°C, 85% RH and 350 VAC, 1,000 hours Capacitance change ($\Delta C/C$): $\leq 10\%$ Dissipation factor change ($\Delta \tan\delta$): $\leq 150 * 10^{-4}$ (at 1 kHz for Cap > 1 μ F) Dissipation factor change ($\Delta \tan\delta$): $\leq 240 * 10^{-4}$ (at 10 kHz for Cap $\leq 1 \mu$ F) IR $\geq 50\%$ of initial limit or minimum 200 M Ω

Approvals

Certification Body	Mark	Specification	File Number
IMQ S.p.A.		EN/IEC 60384-14	Applying
UL		UL 60384-14 and CAN/CSA E60384-14 (350 VAC)	Applying
CQC		IEC 60384-14	Applying

Environmental Compliance



Table 1 – Ratings & Part Number Reference

Capacitance Value (µF)	Dimensions in mm			Lead Spacing (S)	dV/dt (V/µs)	KEMET Part Number	Customer Part Number
	T	H	L				
0.0022	4.0	9.0	13.0	10.0	800	41BF1220(1)T0(2)	R41BF1220(1)T0(2)
0.0033	5.0	11.0	13.0	10.0	800	41BF1330(1)T0(2)	R41BF1330(1)T0(2)
0.0047	5.0	11.0	13.0	10.0	800	41BF1470(1)T1(2)	R41BF1470(1)T1(2)
0.0047	6.0	12.0	13.0	10.0	800	41BF1470(1)T0(2)	R41BF1470(1)T0(2)
0.0068	6.0	12.0	13.0	10.0	800	41BF1680(1)T0(2)	R41BF1680(1)T0(2)
0.0047	5.0	11.0	18.0	15.0	600	41BI1470(1)T0(2)	R41BI1470(1)T0(2)
0.0068	5.0	11.0	18.0	15.0	600	41BI1680(1)T0(2)	R41BI1680(1)T0(2)
0.010	5.0	11.0	18.0	15.0	600	41BI2100(1)T0(2)	R41BI2100(1)T0(2)
0.015	5.0	11.0	18.0	15.0	600	41BI2150(1)T1(2)	R41BI2150(1)T1(2)
0.015	6.0	12.0	18.0	15.0	600	41BI2150(1)T0(2)	R41BI2150(1)T0(2)
0.022	6.0	12.0	18.0	15.0	600	41BI2220(1)T1(2)	R41BI2220(1)T1(2)
0.022	7.5	13.5	18.0	15.0	600	41BI2220(1)T0(2)	R41BI2220(1)T0(2)
0.033	7.5	13.5	18.0	15.0	600	41BI2330(1)T1(2)	R41BI2330(1)T1(2)
0.033	8.5	14.5	18.0	15.0	600	41BI2330(1)T0(2)	R41BI2330(1)T0(2)
0.047	10.0	16.0	18.0	15.0	600	41BI2470(1)T0(2)	R41BI2470(1)T0(2)
0.068	11.0	19.0	18.0	15.0	600	41BI2680(1)T0(2)	R41BI2680(1)T0(2)
0.047	6.0	15.0	26.5	22.5	500	41BN2470(1)T0(2)	R41BN2470(1)T0(2)
0.068	7.0	16.0	26.5	22.5	500	41BN2680(1)T0(2)	R41BN2680(1)T0(2)
0.10	8.5	17.0	26.5	22.5	500	41BN3100(1)T1(2)	R41BN3100(1)T1(2)
0.10	10.0	18.5	26.5	22.5	500	41BN3100(1)T0(2)	R41BN3100(1)T0(2)
0.15	10.0	18.5	26.5	22.5	500	41BN3150(1)T1(2)	R41BN3150(1)T1(2)
0.15	11.0	20.0	26.5	22.5	500	41BN3150(1)T0(2)	R41BN3150(1)T0(2)
0.22	13.0	22.0	26.5	22.5	500	41BN3220(1)T0(2)	R41BN3220(1)T0(2)
0.22	13.0	22.0	32.0	27.5	400	41BR3220(1)T0(2)	R41BR3220(1)T0(2)
0.33	14.0	28.0	32.0	27.5	400	41BR3330(1)T0(2)	R41BR3330(1)T0(2)
0.47	18.0	33.0	32.0	27.5	400	41BR3470(1)T0(2)	R41BR3470(1)T0(2)
0.68	18.0	33.0	32.0	27.5	400	41BR3680(1)T0(2)	R41BR3680(1)T0(2)
0.47	13.0	24.0	41.5	37.5	300	41BW3470(1)T0(2)	R41BW3470(1)T0(2)
0.68	16.0	28.5	41.5	37.5	300	41BW3680(1)T0(2)	R41BW3680(1)T0(2)
1.0	20.0	40.0	41.5	37.5	300	41BW4100(1)T0(2)	R41BW4100(1)T0(2)
1.2	20.0	40.0	41.5	37.5	300	41BW4120(1)T0(2)	R41BW4120(1)T0(2)
Capacitance Value (µF)	T (mm)	H (mm)	L (mm)	Lead Spacing (S)	dV/dt (V/µs)	KEMET Part Number	Customer Part Number

(1) Insert lead and packaging code. See Ordering Options Table for available options.

(2) M = ±20%, K = ±10%

(3) M = ±20% (only available tolerance).

Table 2 – Ratings & Part Number Reference for parts with C-Spec "V106"

Capacitance Value (µF)	Dimensions in mm			Lead Spacing (S)	dV/dt (V/µs)	KEMET Part Number	Customer Part Number
	T	H	L				
0.0022	4.0	9.0	13.0	10.0	800	41BF1220(1)T0(2)V106	R41BF1220(1)T0(2)V106
0.0033	5.0	11.0	13.0	10.0	800	41BF1330(1)T0(2)V106	R41BF1330(1)T0(2)V106
0.0047	5.0	11.0	13.0	10.0	800	41BF1470(1)T1(2)V106	R41BF1470(1)T1(2)V106
0.0047	6.0	12.0	13.0	10.0	800	41BF1470(1)T0(2)V106	R41BF1470(1)T0(2)V106
0.0068	6.0	12.0	13.0	10.0	800	41BF1680(1)T0(2)V106	R41BF1680(1)T0(2)V106
0.0047	5.0	11.0	18.0	15.0	600	41BI1470(1)T0(2)V106	R41BI1470(1)T0(2)V106
0.0068	5.0	11.0	18.0	15.0	600	41BI1680(1)T0(2)V106	R41BI1680(1)T0(2)V106
0.010	5.0	11.0	18.0	15.0	600	41BI2100(1)T0(2)V106	R41BI2100(1)T0(2)V106
0.015	5.0	11.0	18.0	15.0	600	41BI2150(1)T1(2)V106	R41BI2150(1)T1(2)V106
0.015	6.0	12.0	18.0	15.0	600	41BI2150(1)T0(2)V106	R41BI2150(1)T0(2)V106
0.022	6.0	12.0	18.0	15.0	600	41BI2220(1)T1(2)V106	R41BI2220(1)T1(2)V106
0.022	7.5	13.5	18.0	15.0	600	41BI2220(1)T0(2)V106	R41BI2220(1)T0(2)V106
0.033	7.5	13.5	18.0	15.0	600	41BI2330(1)T1(2)V106	R41BI2330(1)T1(2)V106
0.033	8.5	14.5	18.0	15.0	600	41BI2330(1)T0(2)V106	R41BI2330(1)T0(2)V106
0.047	10.0	16.0	18.0	15.0	600	41BI2470(1)T0(2)V106	R41BI2470(1)T0(2)V106
0.068	11.0	19.0	18.0	15.0	600	41BI2680(1)T0(2)V106	R41BI2680(1)T0(2)V106
0.047	6.0	15.0	26.5	22.5	500	41BN2470(1)T0(2)V106	R41BN2470(1)T0(2)V106
0.068	7.0	16.0	26.5	22.5	500	41BN2680(1)T0(2)V106	R41BN2680(1)T0(2)V106
0.10	8.5	17.0	26.5	22.5	500	41BN3100(1)T1(2)V106	R41BN3100(1)T1(2)V106
0.10	10.0	18.5	26.5	22.5	500	41BN3100(1)T0(2)V106	R41BN3100(1)T0(2)V106
0.15	10.0	18.5	26.5	22.5	500	41BN3150(1)T1(2)V106	R41BN3150(1)T1(2)V106
0.15	11.0	20.0	26.5	22.5	500	41BN3150(1)T0(2)V106	R41BN3150(1)T0(2)V106
0.22	13.0	22.0	26.5	22.5	500	41BN3220(1)T0(2)V106	R41BN3220(1)T0(2)V106
0.22	13.0	22.0	32.0	27.5	400	41BR3220(1)T0(2)V106	R41BR3220(1)T0(2)V106
0.33	14.0	28.0	32.0	27.5	400	41BR3330(1)T0(2)V106	R41BR3330(1)T0(2)V106
0.47	18.0	33.0	32.0	27.5	400	41BR3470(1)T0(2)V106	R41BR3470(1)T0(2)V106
0.68	18.0	33.0	32.0	27.5	400	41BR3680(1)T0(2)V106	R41BR3680(1)T0(2)V106
0.47	13.0	24.0	42.0	37.5	300	41BW3470(1)T0(2)V106	R41BW3470(1)T0(2)V106
0.68	16.0	28.5	42.0	37.5	300	41BW3680(1)T0(2)V106	R41BW3680(1)T0(2)V106
1.0	20.0	40.0	42.0	37.5	300	41BW4100(1)T0(2)V106	R41BW4100(1)T0(2)V106
1.2	20.0	40.0	42.0	37.5	300	41BW4120(1)T0(2)V106	R41BW4120(1)T0(2)V106
Capacitance Value (µF)	T (mm)	H (mm)	L (mm)	Lead Spacing (S)	dV/dt (V/µs)	KEMET Part Number	Customer Part Number

(1) Insert lead and packaging code. See Ordering Options Table for available options.

(2) M = ±20%, K = ±10%

Soldering Process

The implementation of the RoHS directive has resulted in the selection of SnAgCu (SAC) alloys or SnCu alloys as primary solder. This has increased the liquidus temperature from that of 183°C for SnPb eutectic alloy to 217 – 221°C for the new alloys. As a result, the heat stress to the components, even in wave soldering, has increased considerably due to higher pre-heat and wave temperatures. Polypropylene capacitors are especially sensitive to heat (the melting point of polypropylene is 160 – 170°C). Wave soldering can be destructive, especially for mechanically small polypropylene capacitors (with lead spacing of 5 mm to 15 mm), and great care has to be taken during soldering. The recommended solder profiles from KEMET should be used. Please consult KEMET with any questions. In general, the wave soldering curve from IEC Publication 61760-1 Edition 2 serves as a solid guideline for successful soldering. Please see Figure 1.

Reflow soldering is not recommended for through-hole film capacitors. Exposing capacitors to a soldering profile in excess of the above the recommended limits may result to degradation or permanent damage to the capacitors.

Do not place the polypropylene capacitor through an adhesive curing oven to cure resin for surface mount components. Insert through-hole parts after the curing of surface mount parts. Consult KEMET to discuss the actual temperature profile in the oven, if through-hole components must pass through the adhesive curing process. A maximum two soldering cycles is recommended. Please allow time for the capacitor surface temperature to return to a normal temperature before the second soldering cycle.

Manual Soldering Recommendations

The following is the recommendation for manual soldering with a soldering iron.

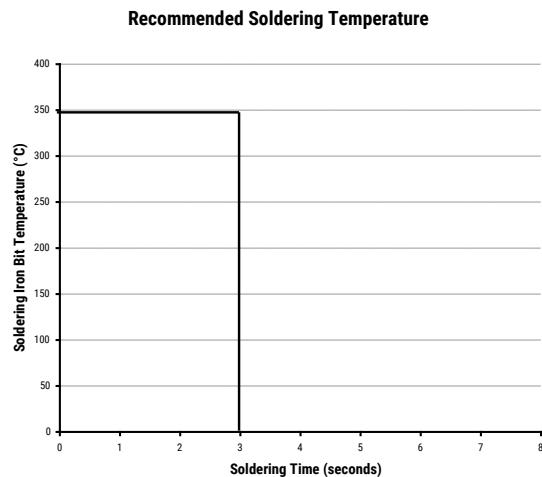

The soldering iron tip temperature should be set at 350°C (+10°C maximum) with the soldering duration not to exceed more than 3 seconds.

Wave Soldering Recommendations

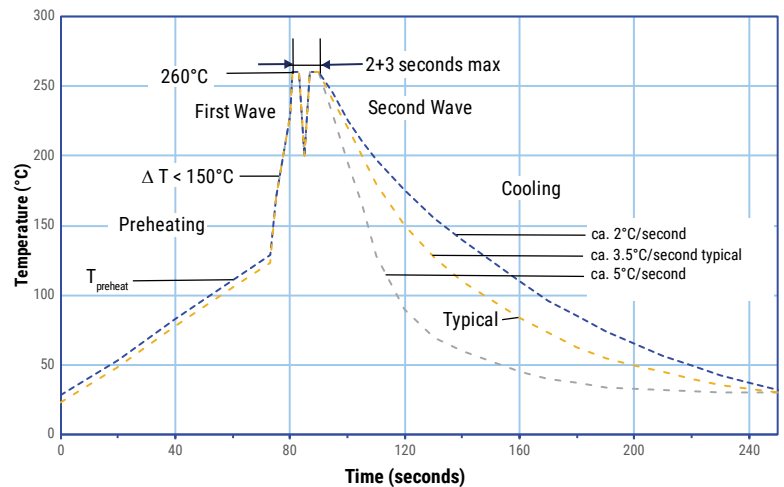

Soldering Process cont.

Wave Soldering Recommendations cont.

1. The table indicates the maximum set-up temperature of the soldering process
Figure 1

Dielectric Film Material	Maximum Preheat Temperature		Maximum Peak Soldering Temperature	
	Capacitor Pitch ≤ 15 mm	Capacitor Pitch > 15 mm	Capacitor Pitch ≤ 15 mm	Capacitor Pitch > 15 mm
Polyester	130°C	130°C	270°C	270°C
Polypropylene	125°C	130°C	260°C	270°C
Paper	130°C	140°C	270°C	270°C
Polyphenylene Sulphide	150°C	160°C	270°C	270°C

2. The maximum temperature measured inside the capacitor:

Set the temperature so that inside the element the maximum temperature is below the limit:

Dielectric Film Material	Maximum temperature measured inside the element
Polyester	160°C
Polypropylene	125°C
Paper	160°C
Polyphenylene sulphide	160°C

Temperature monitored inside the capacitor.

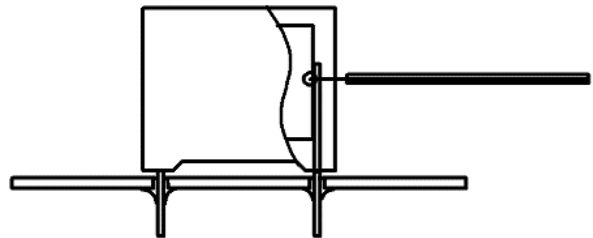

Selective Soldering Recommendations

Selective dip soldering is a variation of reflow soldering. In this method, the printed circuit board with through-hole components to be soldered is preheated and transported over the solder bath as in normal flow soldering without touching the solder. When the board is over the bath, it is stopped and pre-designed solder pots are lifted from the bath with molten solder only at the places of the selected components, and pressed against the lower surface of the board to solder the components.

The temperature profile for selective soldering is similar to the double wave flow soldering outlined in this document, **however, instead of two baths, there is only one bath with a time from 3 to 10 seconds.** In selective soldering, the risk of overheating is greater than in double wave flow soldering, and great care must be taken so that the parts are not overheated.

Mounting

Resistance to Vibration and Mechanical Shock

AEC-Q200 Mechanical Stress Tests:

Mechanical Shock	MIL-SDT-202 Method 213	Test condition C Peak value 100 g, duration 6 ms, half-sine-wave (see MIL-HDBK for details)
Vibration	MIL-SDT-202 Method 204	5 g for 20 minutes, 12 cycles each of 3 orientations Use 8"X5" PCB, 0.031" thick. 7 secure points on one 8" side and 2 secure points at corners of opposite sides. Parts mounted within 2" from any secure point. Test from 10 – 2,000 Hz.

The capacitors are designed for PCB mounting. The stand-off pipes must be in good contact with the printed circuit board. The capacitors with pitch ≤ 22.5 mm can be mechanically fixed by the leads, for pitch > 22.5 mm, the capacitor body has to be properly fixed (e.g. clamped or glued).

Construction

2 Sections

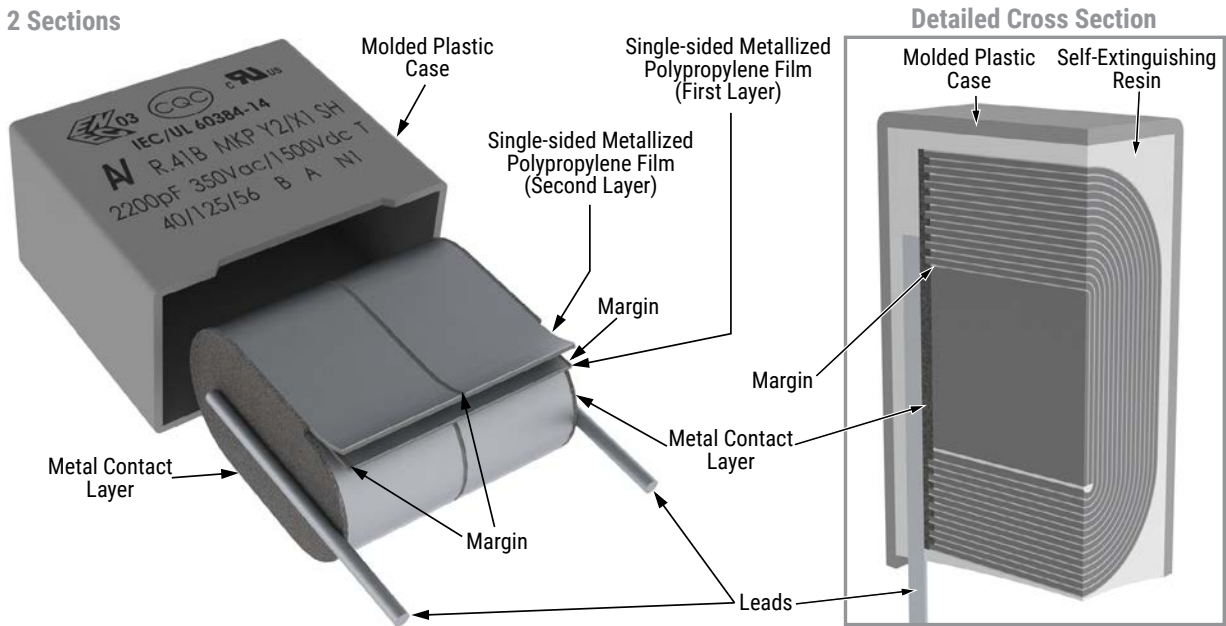

Winding Scheme

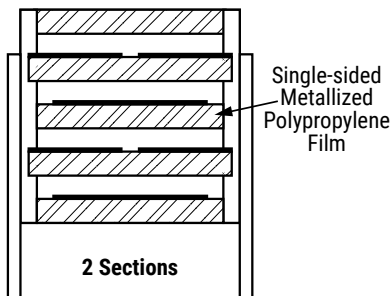

With C-Spec "V106", the case will be in black color



Marking

Lead Spacing 10 mm (Small Case Sizes)

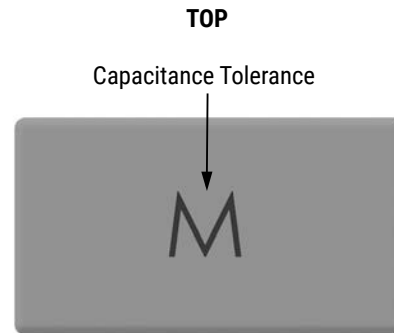
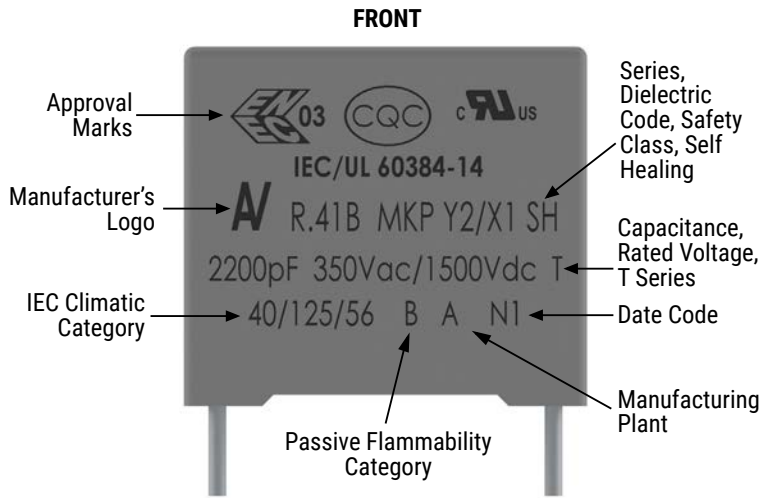

NOTE: Hot imprinting with or without color or ink jet or laser marking

Lead Spacing 15 – 27.5 mm (Small Case Sizes)

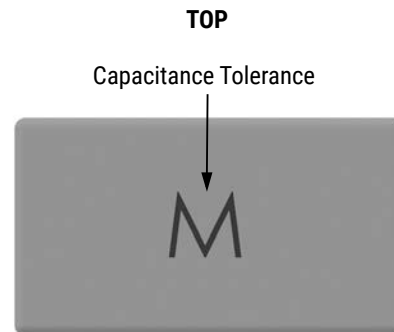
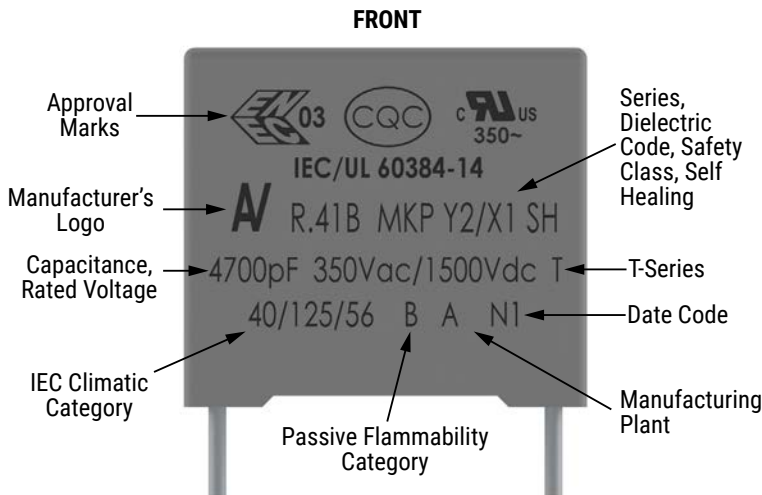

NOTE: Hot imprinting with or without color or ink jet or laser marking

Manufacturing Date Code (IEC 60062)

Year	Code	Year	Code	Year	Code	Month	Code	Month	Code
2010	A	2017	J	2024	S	January	1	July	7
2011	B	2018	K	2025	T	February	2	August	8
2012	C	2019	L	2026	U	March	3	September	9
2013	D	2020	M	2027	V	April	4	October	0
2014	E	2021	N	2028	W	May	5	November	N
2015	F	2022	P	2029	X	June	6	December	D
2016	H	2023	R	2030	A				

Marking cont.

Lead Spacing 27.5 mm (alternatives*) and 37.5 mm

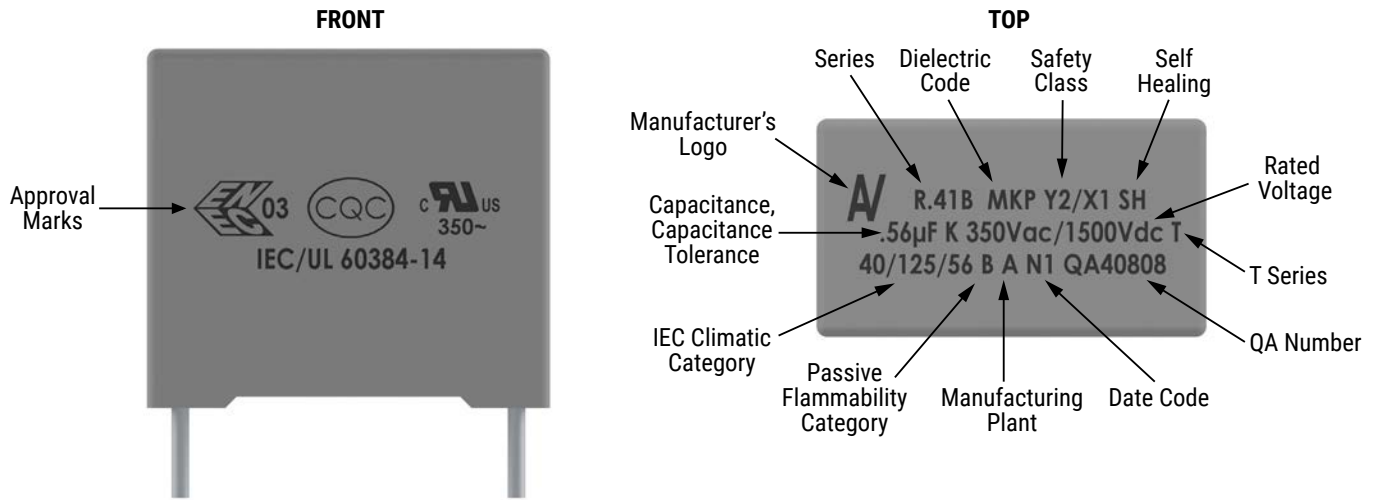

* Differences caused by technology (clichee, laser or ink jet) and production line

Lead Spacing 10 mm (C-Spec "V106")

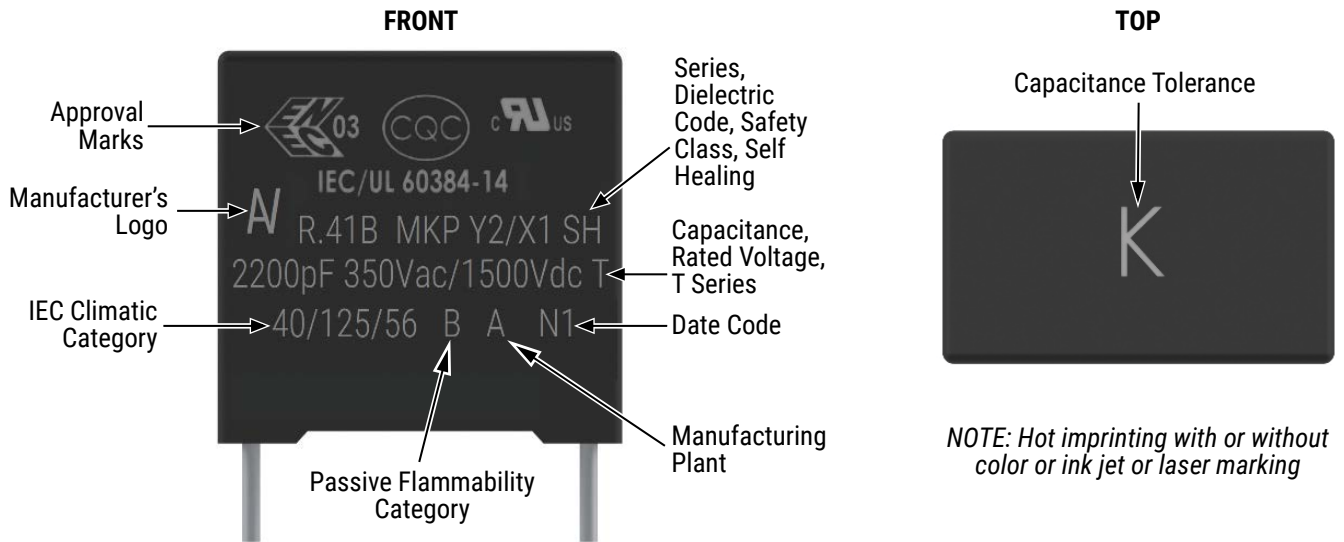

Manufacturing Date Code (IEC 60062)									
Year	Code	Year	Code	Year	Code	Month	Code	Month	Code
2010	A	2017	J	2024	S	January	1	July	7
2011	B	2018	K	2025	T	February	2	August	8
2012	C	2019	L	2026	U	March	3	September	9
2013	D	2020	M	2027	V	April	4	October	0
2014	E	2021	N	2028	W	May	5	November	N
2015	F	2022	P	2029	X	June	6	December	D
2016	H	2023	R	2030	A				

Packaging Quantities

Lead Spacing (mm)	Thickness (mm)	Height (mm)	Length (mm)	Bulk Short Leads	Bulk Long Leads	Standard Reel ø 355 mm	Large Reel ø 500 mm	Ammo Taped	T19 Pizza Short Leads	T19 Pizza Long Leads
				00 - JA - JB JE - JH	JM - 40 - 50	GY - CK ¹	CK	DQ	00	40 - 50
10	4.0	9.0	13.0	2,000	1,800	750	1,500	1,000	-	1,000
	5.0	11.0	13.0	1,300	1,500	600	1,250	800	-	800
	6.0	12.0	13.0	1,000	1,200	500	1,000	680	-	680
15	5.0	11.0	18.0	2,000	1,000	600	1,250	800	-	800
	6.0	12.0	18.0	1,750	900	500	1,000	680	-	680
	7.5	13.5	18.0	1,000	700	350	800	500	-	500
	8.5	14.5	18.0	1,000	500	300	700	440	-	440
	10.0	16.0	18.0	750	500	270	600	380	-	380
	11.0	19.0	18.0	450	350	270	500	340	-	340
22.5	6.0	15.0	26.5	805	500	300	700	464	-	464
	7.0	16.0	26.5	700	500	250	550	380	-	380
	8.5	17.0	26.5	468	300	250	450	280	-	280
	10.0	18.5	26.5	396	300	160	350	235	-	235
	11.0	20.0	26.5	360	250	160	350	217	-	217
	13.0	22.0	26.5	300	200	130	300	-	-	-
27.5	13.0	22.0	32.0	480	288	-	300	-	-	-
	14.0	28.0	32.0	352	176	-	-	-	-	-
	18.0	33.0	32.0	256	128	-	-	-	-	-
37.5	13.0	24.0	41.5	360	216	-	-	-	-	-
	16.0	28.5	41.5	216	108	-	-	-	-	-
	20.0	40.0	41.5	126	84	-	-	-	-	-
R41B with C-Spec "V106" in black case:										
37.5	13.0	24.0	42.0	-	-	-	-	-	168	84
	16.0	28.5	42.0	-	-	-	-	-	66	66
	20.0	40.0	42.0	-	-	-	-	-	58	58

Lead Taping & Packaging (IEC 60286-2)

Figure 1
Lead Spacing 10 mm

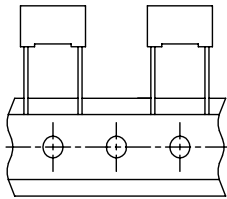

Figure 2
Lead Spacing 15 mm

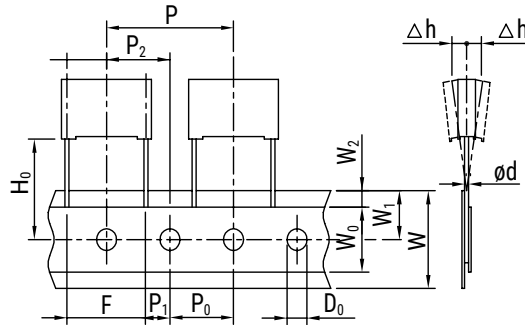
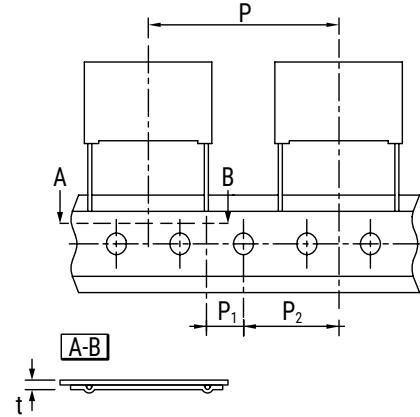

Figure 3
Lead Spacing 22.5 – 27.5 mm



Taping Specification

Description	Symbol	Dimensions (mm)					Tol.
		Lead Space					
		10 Fig. 1	15 Fig. 2	22.5 Fig. 3	27.5 Fig. 3		
Lead wire diameter	d	0.6	0.6–0.8	0.8	0.8	±0.05	
Taping lead space	P	25.4	25.4	38.1	38.1	±1	
Feed hole lead space *	P ₀	12.7	12.7	12.7	12.7	±0.2 **	
Centering of the lead wire	P ₁	7.7	5.2	7.8	5.3	±0.7	
Centering of the body	P ₂	12.7	12.7	19.05	19.05	±1.3	
Lead spacing (pitch) ***	F	10	15	22.5	27.5	+0.6/-0.1	
Component alignment	Δh	0	0	0	0	±2	
Height of component from tape center	H ₀ ****	18.5	18.5	18.5	18.5	±0.5	
Carrier tape width	W	18	18	18	18	+1/-0.5	
Hold down tape width	W ₀	9	10	10	10	Minimum	
Hole position	W ₁	9	9	9	9	±0.5	
Hold down tape position	W ₂	3	3	3	3	Maximum	
Feed hole diameter	D ₀	4	4	4	4	±0.2	
Total tape thickness	t	0.7	0.7	0.7	0.7	±0.2	

* 15 mm also available

** Maximum of 1 mm on 20 lead spaces

*** Pitches 15 mm and 10 mm taped to 7.5 mm (crimped leads) available upon request

**** H₀ = 16.5 mm is available upon request

Lead Taping & Packaging (IEC 60286-2) cont.

Ammo Specifications

Dimensions (mm)		
H	W	T
360	340	59

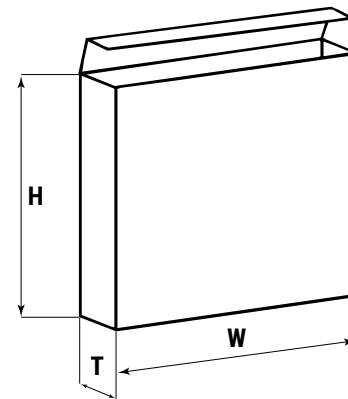

Reel Specifications

Reel Size	Dimensions (mm)		
	D	H	W
Standard	355	30	55 Maximum
Large	500	25	

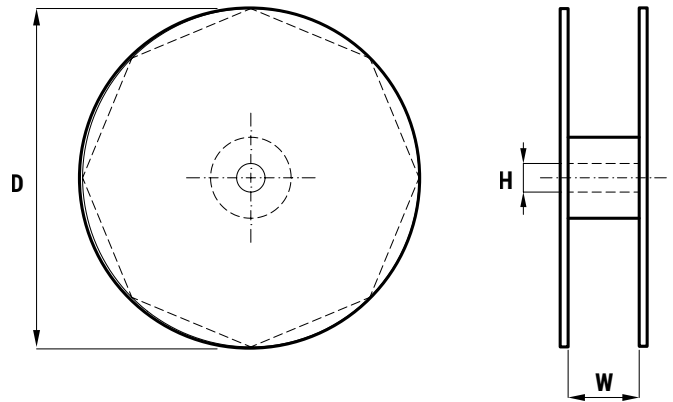

KEMET Electronics Corporation Sales Offices

For a complete list of our global sales offices, please visit www.kemet.com/sales.

Disclaimer

All product specifications, statements, information and data (collectively, the "Information") in this datasheet are subject to change. The customer is responsible for checking and verifying the extent to which the Information contained in this publication is applicable to an order at the time the order is placed. All Information given herein is believed to be accurate and reliable, but it is presented without guarantee, warranty, or responsibility of any kind, expressed or implied.

Statements of suitability for certain applications are based on KEMET Electronics Corporation's ("KEMET") knowledge of typical operating conditions for such applications, but are not intended to constitute – and KEMET specifically disclaims – any warranty concerning suitability for a specific customer application or use. The Information is intended for use only by customers who have the requisite experience and capability to determine the correct products for their application. Any technical advice inferred from this Information or otherwise provided by KEMET with reference to the use of KEMET's products is given gratis, and KEMET assumes no obligation or liability for the advice given or results obtained.

Although KEMET designs and manufactures its products to the most stringent quality and safety standards, given the current state of the art, isolated component failures may still occur. Accordingly, customer applications which require a high degree of reliability or safety should employ suitable designs or other safeguards (such as installation of protective circuitry or redundancies) in order to ensure that the failure of an electrical component does not result in a risk of personal injury or property damage.

Although all product-related warnings, cautions and notes must be observed, the customer should not assume that all safety measures are indicated or that other measures may not be required.

KEMET is a registered trademark of KEMET Electronics Corporation.