

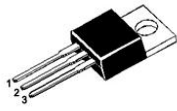

# MUR1040CT/FCT/DC/CS/D

## ULTRAFAST RECOVERY RECTIFIERS



TO-220AB/CT

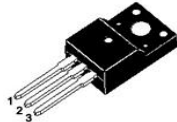

TO-220F/FCT

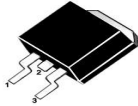

TO-263/DC



TO-252/CS

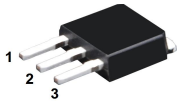

TO-251/D

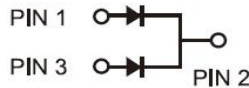

## FEATURES

- High speed switching capability
- High current capability
- High forward surge capability
- Low power losses. High efficiency
- High reliability
- For use in low voltage, high frequency inverters



RoHS  
COMPLIANT

## APPLICATIONS

Fast recovery diode, mainly used for rectification, used in high-power equipment, The express and ultrafast recovery diodes are suitable for high frequency and ultra high frequency circuits, respectively

## Primary Characteristic

$I_O$	2*5A
$V_{RRM}$	400V
$I_{FSM}$	100A
$V_F$	1.03V
$T_{Jmax}$	175°C

## MECHANICAL DATA

- **Case:** Molded plastic
- **Polarity:** As marked
- **Mounting Position:** Any
- **Molded Plastic:** UL Flammability Classification Rating 94V-0
- Lead free in compliance with EU RoHS 2011/65/EU directive
- Solder bath temperature 275°C maximum, 10s per JESD 22-B106

## Maximum Ratings (Per Leg) at Ta=25°C unless otherwise specified

Characteristics	Symbol	Value	Unit
Maximum Repetitive Peak Reverse Voltage	$V_{RRM}$	400	V
Working Peak Reverse Voltage	$V_{RWM}$	400	V
Maximum DC Blocking Voltage	$V_{DC}$	400	V
Maximum Average Forward Rectified Current	$I_O$	Per Leg	5
		Total	10
Peak Forward Surge Current, 8.3 ms Single Half Sine-wave Superimposed on Rated Load (JEDEC method)	$I_{FSM}$	100	A
Operating Temperature Range	$T_J$	175	°C
Storage Temperature Range	$T_{STG}$	-40 to +175	°C
Typical Thermal Resistance (Note1)	$R_{\theta JC}$	TO-220AB, TO-263	2
		TO-220F	4

Note1: Thermal resistance from Junction to case per leg mounted on heatsink.

## Electrical Characteristics (Per Leg) unless otherwise specified

Characteristics	Symbol	Value		Unit	
Forward Voltage Drop(Note2)	$V_F$	Typ.	Max.	V	
		at $I_F=1A$			
		0.92	-		
		0.79	-		
at $I_F=3A$		1.05	-		
		0.94	-		
at $I_F=5A$		1.13	1.43		
		1.03	-		
Maximum Reverse Current at $V_R=400V$	$I_R$	TA=25°C	10		μA
		TA=125°C	1		μA
Maximum Reverse Recovery Time at $I_F=0.5A, I_R=1A,$	$T_{rr}$	13	30	ns	

Note2: Pulse test: 300 μs pulse width, 1 % duty cycle



## RATINGS AND CHARACTERISTIC CURVES

FIG. 1 MAXIMUM FORWARD CURRENT DERATING CURVE

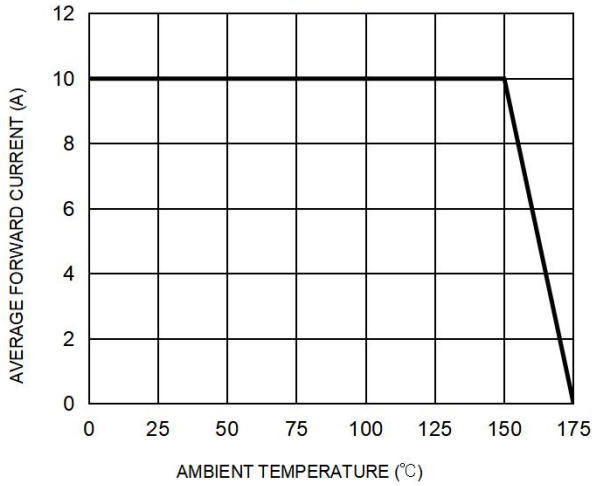

FIG. 2 MAXIMUM NON-REPETITIVE FORWARD SURGE CURRENT PER LEG

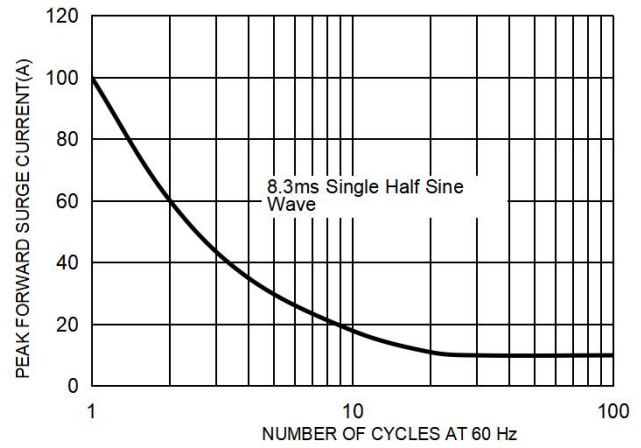

FIG. 3 TYPICAL FORWARD CHARACTERISTICS PER LEG

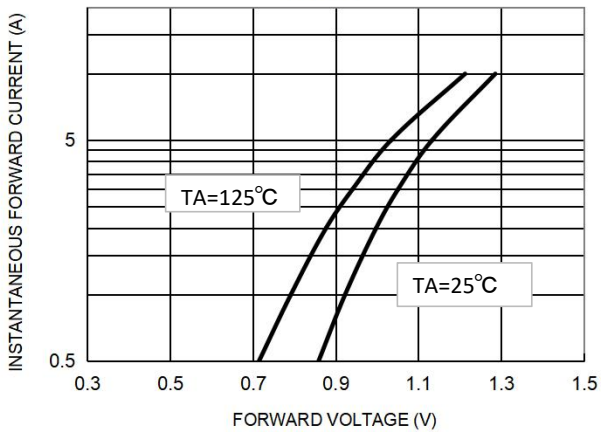
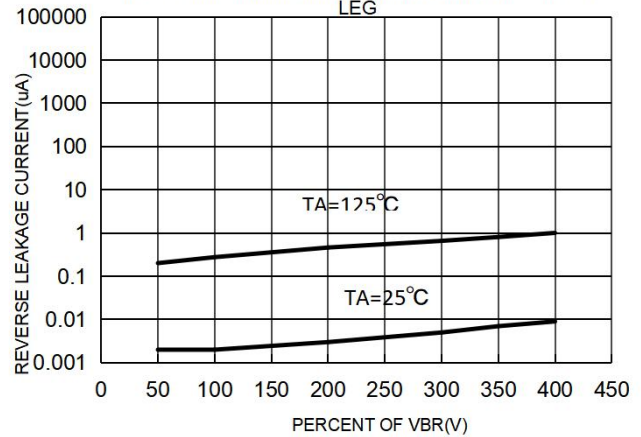

FIG. 4 TYPICAL REVERSE CHARACTERISTICS PER LEG





# MUR1040CT/FCT/DC/CS/D

## Package Outline Dimensions millimeters

### TO-220AB

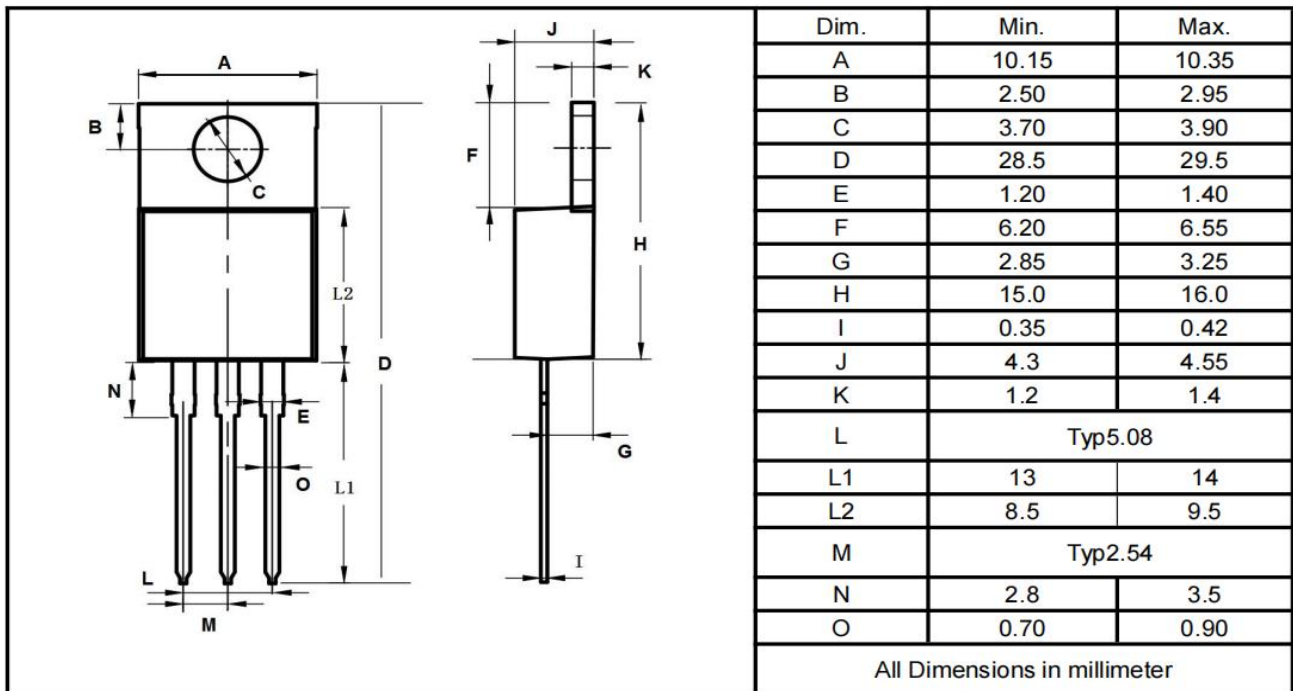

### TO-220F

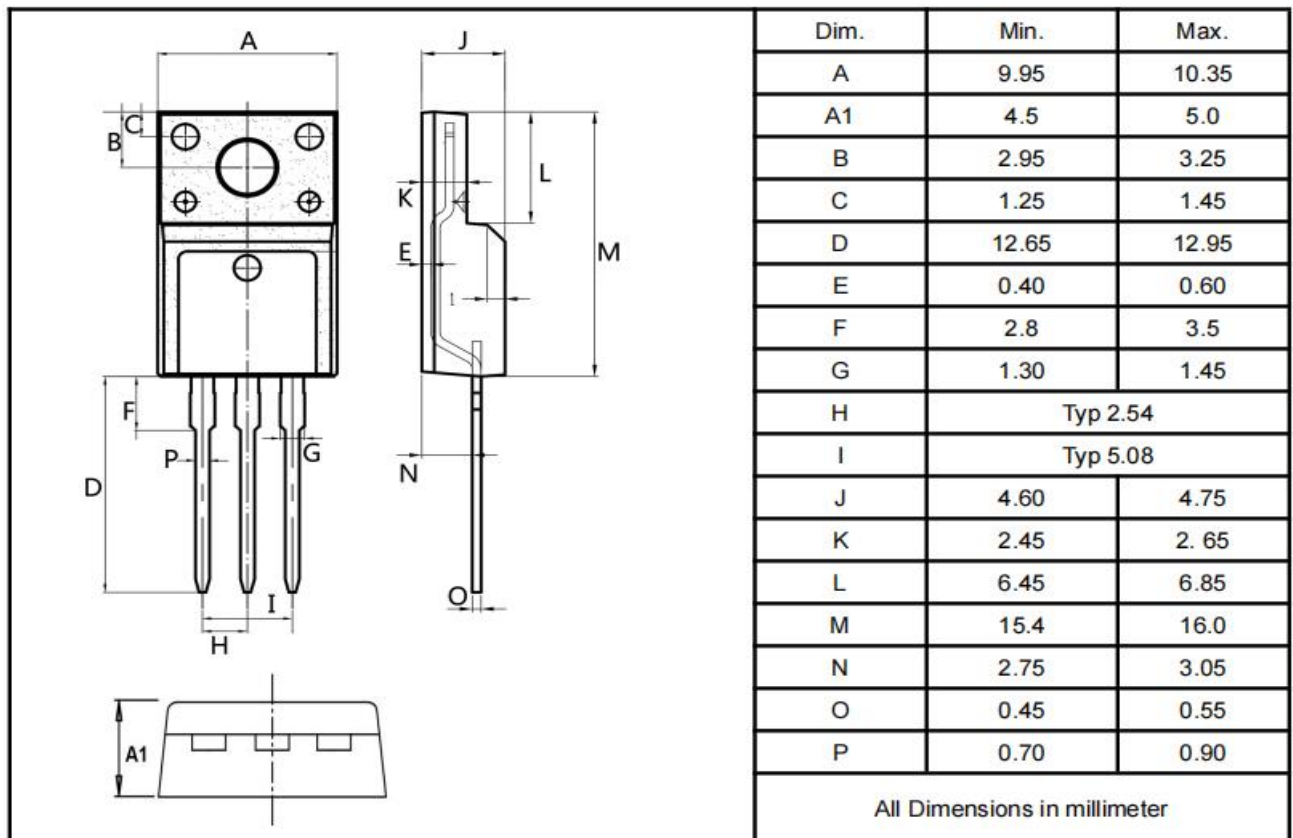



Package Outline Dimensions millimeters

T0-263

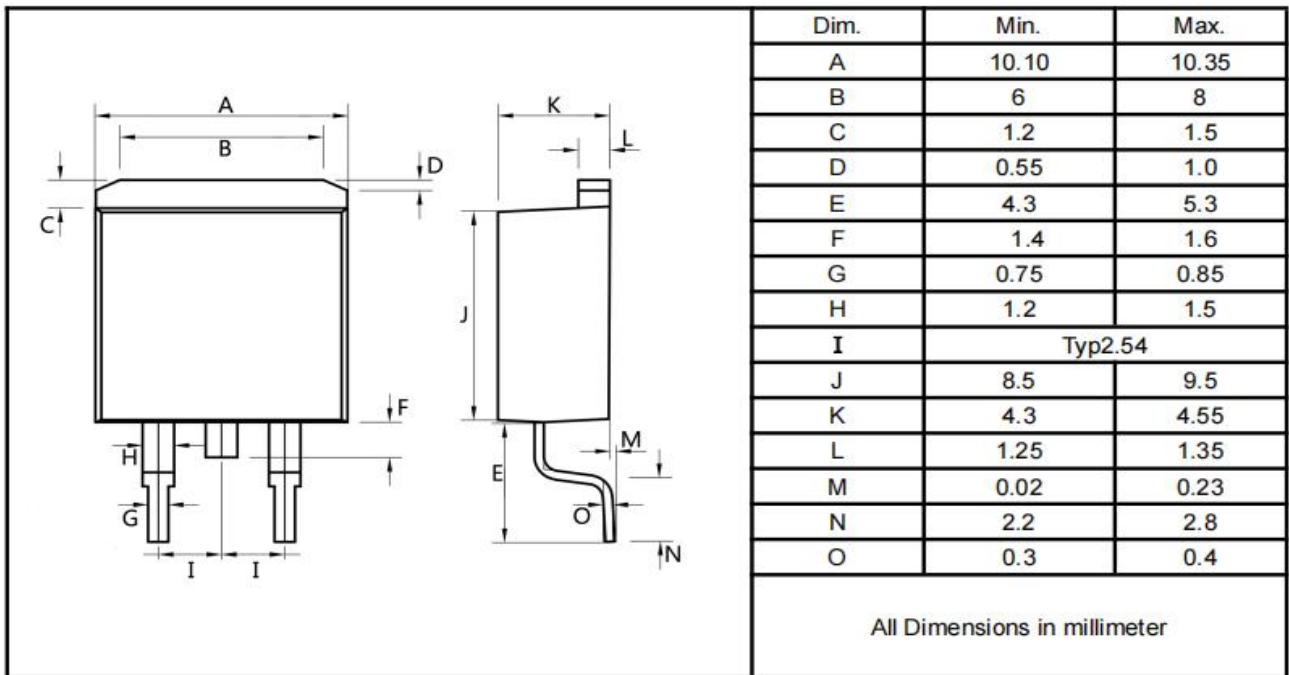

T0-252

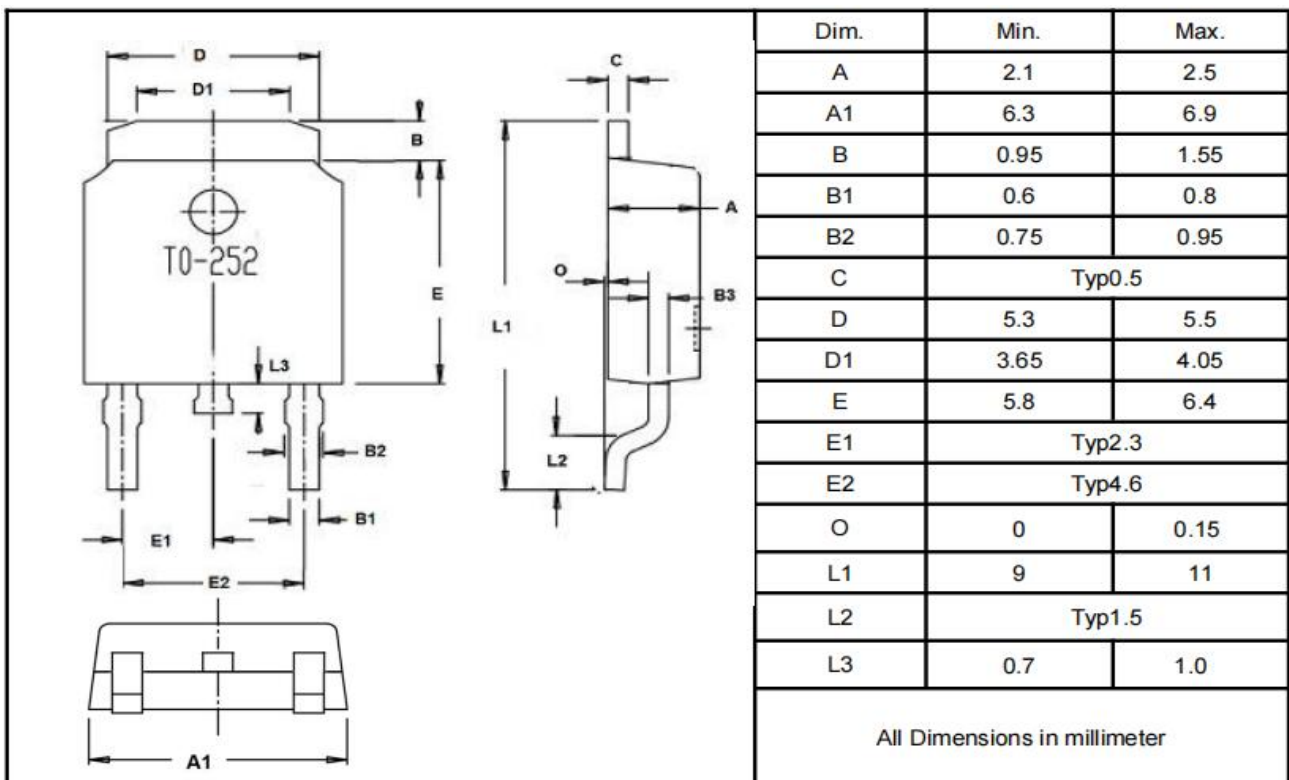



# MUR1040CT/FCT/DC/CS/D

## Package Outline Dimensions millimeters

TO-251

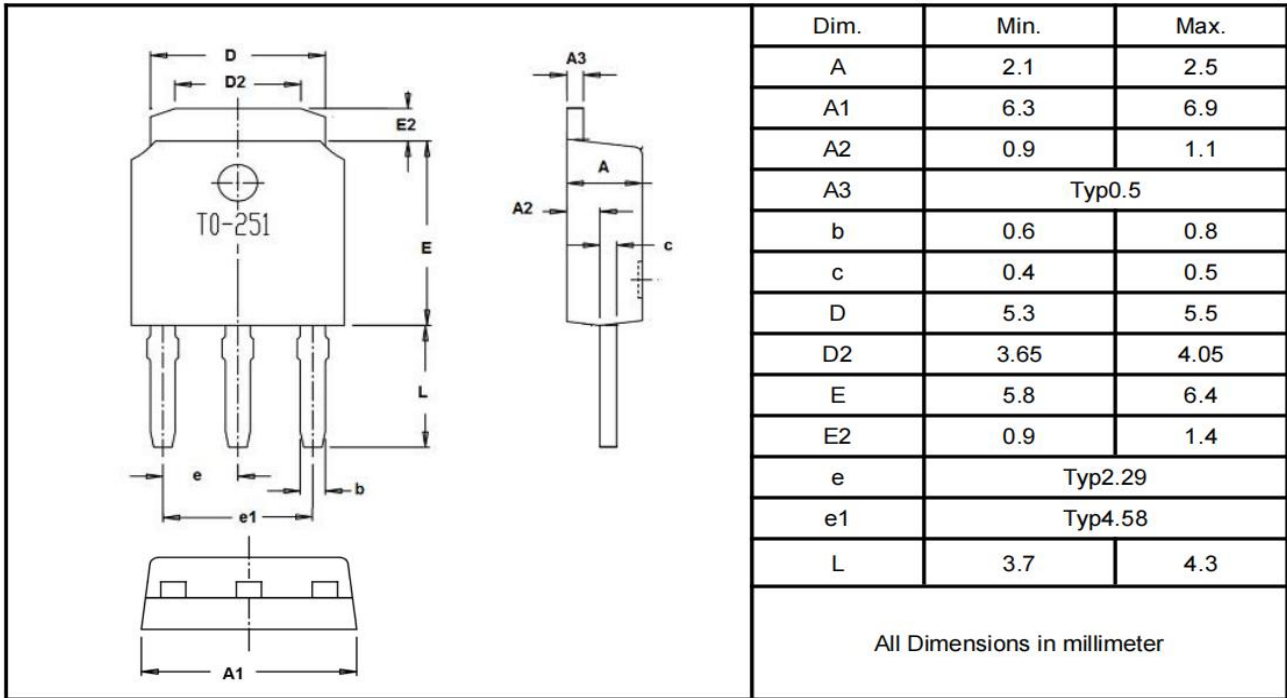

## Marking on the body

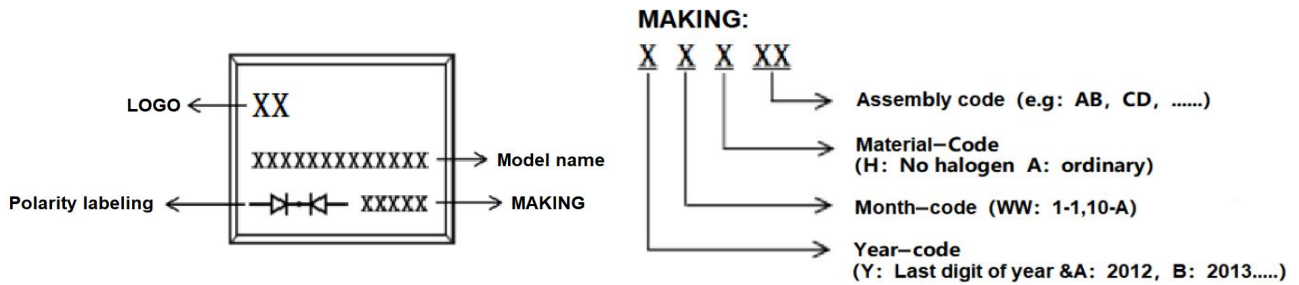

## Ordering information

Part Number	Package	Unit Weight	Base Quantity	Delivery mode
MUR1040CT	TO-220AB	0.07oz(1.96g)	50 pcs / tube	1000pcs/box 5000pcs/carton
MUR1040FCT	TO-220F	0.06oz(1.74g)	50 pcs / tube	1000pcs/box 5000pcs/carton
MUR1040DC	TO-263	0.04oz(1.16g)	50 pcs / tube	1000pcs/box 5000pcs/carton
MUR1040DC-R	TO-263	0.04oz(1.16g)	800 pcs / reel	1600pcs/box 8000pcs/carton
MUR1040CS	TO-252	0.011oz(0.32g)	2500 pcs / reel	5000pcs/box 25000pcs/carton
MUR1040D	TO-251	0.011oz(0.32g)	80 pcs / tube	4000pcs/box 24000pcs/carton

Note: For Halogen Free molding compound, add "H" suffix to part number above.



# MUR1040CT/FCT/DC/CS/D

## packing instruction

PKG	最小包装	内盒	外箱
TO-220AB TO-220F TO-263			
	50pcs/管	1000pcs/盒	5000pcs/箱
TO-263-R			
	800pcs/盘	1600pcs/盒	8000pcs/箱
TO-252			
	2500pcs/盘	5000pcs/盘	25000pcs/箱
TO-251			
	80pcs/管	4000pcs/盒	24000pvs/箱

## Notice

1. All product, product specifications and data are subject to change without notice to improve. The right to explain is owned by LINGXUN electronics company.

2. Confirm that operation temperature is within the specified range described in the product specification. Avoid applying power exceeding normal rated power;

exceeding the power rating under steady-state loading condition may negatively affect product performance and reliability.

3. LINGXUN electronics shall not be in any way responsible or liable for failure induced under deviant condition from what is defined in this document.