

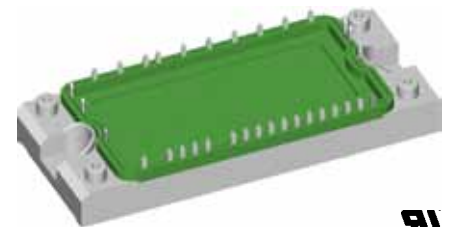
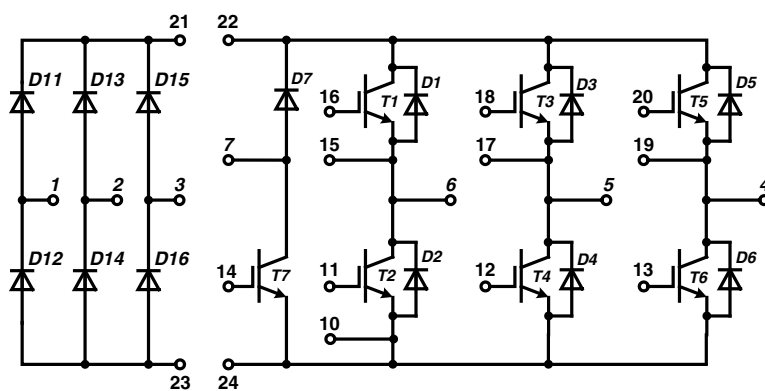
# Converter - Brake - Inverter Module

## XPT IGBT

Three Phase Rectifier	Brake Chopper	Three Phase Inverter
$V_{RRM} = 1600 \text{ V}$	$V_{CES} = 1200 \text{ V}$	$V_{CES} = 1200 \text{ V}$
$I_{DAVM} = 105 \text{ A}$	$I_{C25} = 28 \text{ A}$	$I_{C25} = 60 \text{ A}$
$I_{FSM} = 320 \text{ A}$	$V_{CE(sat)} = 1.8 \text{ V}$	$V_{CE(sat)} = 1.8 \text{ V}$

**Part name** (Marking on product)

MIXA40WB1200TED



E 72873

Pin configuration see outlines.

### Features:

- Easy paralleling due to the positive temperature coefficient of the on-state voltage
- Rugged XPT design (Xtreme light Punch Through) results in:
  - short circuit rated for 10  $\mu\text{sec}$ .
  - very low gate charge
  - square RBSOA @  $3 \times I_C$
  - low EMI
- Thin wafer technology combined with the XPT design results in a competitive low  $V_{CE(sat)}$
- SONIC™ diode
  - fast and soft reverse recovery
  - low operating forward voltage

### Application:

- AC motor drives
- Solar inverter
- Medical equipment
- Uninterruptible power supply
- Air-conditioning systems
- Welding equipment
- Switched-mode and resonant-mode power supplies

### Package:

- "E2-Pack" standard outline
- Insulated copper base plate
- Soldering pins for PCB mounting
- Temperature sense included

**Output Inverter T1 - T6**

Symbol	Definitions	Conditions	Ratings				
			min.	typ.	max.	Unit	
$V_{CES}$	collector emitter voltage		$T_{VJ} = 25^{\circ}\text{C}$		1200	V	
$V_{GES}$	max. DC gate voltage	continuous			$\pm 20$	V	
$V_{GEM}$	max. transient collector gate voltage	transient			$\pm 30$	V	
$I_{C25}$	collector current		$T_C = 25^{\circ}\text{C}$		60	A	
$I_{C80}$			$T_C = 80^{\circ}\text{C}$		40	A	
$P_{tot}$	total power dissipation		$T_C = 25^{\circ}\text{C}$		195	W	
$V_{CE(sat)}$	collector emitter saturation voltage	$I_C = 35\text{ A}; V_{GE} = 15\text{ V}$	$T_{VJ} = 25^{\circ}\text{C}$ $T_{VJ} = 125^{\circ}\text{C}$	1.8 2.1	2.1	V V	
$V_{GE(th)}$	gate emitter threshold voltage	$I_C = 1.5\text{ mA}; V_{GE} = V_{CE}$	$T_{VJ} = 25^{\circ}\text{C}$	5.4	6.0	6.5	V
$I_{CES}$	collector emitter leakage current	$V_{CE} = V_{CES}; V_{GE} = 0\text{ V}$	$T_{VJ} = 25^{\circ}\text{C}$ $T_{VJ} = 125^{\circ}\text{C}$		0.2	2.1	mA mA
$I_{GES}$	gate emitter leakage current	$V_{GE} = \pm 20\text{ V}$			500	nA	
$Q_{G(on)}$	total gate charge	$V_{CE} = 600\text{ V}; V_{GE} = 15\text{ V}; I_C = 35\text{ A}$			106	nC	
$t_{d(on)}$	turn-on delay time	inductive load $V_{CE} = 600\text{ V}; I_C = 35\text{ A}$ $V_{GE} = \pm 15\text{ V}; R_G = 27\ \Omega$	$T_{VJ} = 125^{\circ}\text{C}$		70	ns	
$t_r$	current rise time				40	ns	
$t_{d(off)}$	turn-off delay time				250	ns	
$t_f$	current fall time				100	ns	
$E_{on}$	turn-on energy per pulse				3.8	mJ	
$E_{off}$	turn-off energy per pulse				4.1	mJ	
<b>RBSOA</b>	reverse bias safe operating area	$V_{GE} = \pm 15\text{ V}; R_G = 27\ \Omega;$	$T_{VJ} = 125^{\circ}\text{C}$ $V_{CEK} = 1200\text{ V}$		105	A	
<b>SCSOA</b>	short circuit safe operating area		$T_{VJ} = 125^{\circ}\text{C}$		10	$\mu\text{s}$	
$t_{SC}$	short circuit duration	$V_{CE} = 900\text{ V}; V_{GE} = \pm 15\text{ V};$ $R_G = 27\ \Omega;$ non-repetitive			140	A	
$I_{SC}$	short circuit current						
$R_{thJC}$	thermal resistance junction to case	(per IGBT)			0.64	K/W	

**Output Inverter D1 - D6**

Symbol	Definitions	Conditions	Ratings			
			min.	typ.	max.	Unit
$V_{RRM}$	max. repetitive reverse voltage		$T_{VJ} = 25^{\circ}\text{C}$		1200	V
$I_{F25}$	forward current		$T_C = 25^{\circ}\text{C}$		44	A
$I_{F80}$			$T_C = 80^{\circ}\text{C}$		29	A
$V_F$	forward voltage	$I_F = 30\text{ A}; V_{GE} = 0\text{ V}$	$T_{VJ} = 25^{\circ}\text{C}$ $T_{VJ} = 125^{\circ}\text{C}$	1.95 1.95	2.2	V V
$Q_{rr}$	reverse recovery charge	$V_R = 600\text{ V}$ $di_f/dt = -600\text{ A}/\mu\text{s}$ $I_F = 30\text{ A}; V_{GE} = 0\text{ V}$	$T_{VJ} = 125^{\circ}\text{C}$		3.5	$\mu\text{C}$
$I_{RM}$	max. reverse recovery current				30	A
$t_{rr}$	reverse recovery time				350	ns
$E_{rec}$	reverse recovery energy				0.9	mJ
$R_{thJC}$	thermal resistance junction to case	(per diode)			1.2	K/W

 $T_C = 25^{\circ}\text{C}$  unless otherwise stated

**Brake T7**

Symbol	Definitions	Conditions	Ratings			Unit	
			min.	typ.	max.		
$V_{CES}$	collector emitter voltage	$T_{VJ} = 25^{\circ}\text{C}$			1200	V	
$V_{GES}$	max. DC gate voltage	continuous			$\pm 20$	V	
$V_{GEM}$	max. transient collector gate voltage	transient			$\pm 30$	V	
$I_{C25}$	collector current	$T_C = 25^{\circ}\text{C}$			28	A	
$I_{C80}$		$T_C = 80^{\circ}\text{C}$			20	A	
$P_{tot}$	total power dissipation	$T_C = 25^{\circ}\text{C}$			100	W	
$V_{CE(sat)}$	collector emitter saturation voltage	$I_C = 16\text{ A}; V_{GE} = 15\text{ V}$			1.8 2.1	V V	
$V_{GE(th)}$	gate emitter threshold voltage	$I_C = 0.6\text{ mA}; V_{GE} = V_{CE}$	$T_{VJ} = 25^{\circ}\text{C}$	5.4	6.0	6.5	V
$I_{CES}$	collector emitter leakage current	$V_{CE} = V_{CES}; V_{GE} = 0\text{ V}$	$T_{VJ} = 25^{\circ}\text{C}$ $T_{VJ} = 125^{\circ}\text{C}$		0.1	0.1	mA mA
$I_{GES}$	gate emitter leakage current	$V_{GE} = \pm 20\text{ V}$				500	nA
$Q_{G(on)}$	total gate charge	$V_{CE} = 600\text{ V}; V_{GE} = 15\text{ V}; I_C = 15\text{ A}$			48		nC
$t_{d(on)}$	turn-on delay time	inductive load $V_{CE} = 600\text{ V}; I_C = 15\text{ A}$ $V_{GE} = \pm 15\text{ V}; R_G = 56\ \Omega$	$T_{VJ} = 125^{\circ}\text{C}$		70		ns
$t_r$	current rise time				40		ns
$t_{d(off)}$	turn-off delay time				250		ns
$t_f$	current fall time				100		ns
$E_{on}$	turn-on energy per pulse				1.6		mJ
$E_{off}$	turn-off energy per pulse				1.7		mJ
<b>RBSOA</b>	reverse bias safe operating area	$V_{GE} = \pm 15\text{ V}; R_G = 56\ \Omega;$	$T_{VJ} = 125^{\circ}\text{C}$ $V_{CEK} = 1200\text{ V}$			45	A
<b>SCSOA</b>	short circuit safe operating area		$T_{VJ} = 125^{\circ}\text{C}$				
$t_{SC}$	short circuit duration	$V_{CE} = 900\text{ V}; V_{GE} = \pm 15\text{ V};$				10	$\mu\text{s}$
$I_{SC}$	short circuit current	$R_G = 56\ \Omega;$ non-repetitive			60		A
$R_{thJC}$	thermal resistance junction to case	(per IGBT)				1.26	K/W

**Brake Chopper D7**

Symbol	Definitions	Conditions	Ratings			Unit	
			min.	typ.	max.		
$V_{RRM}$	max. repetitive reverse voltage	$T_{VJ} = 25^{\circ}\text{C}$			1200	V	
$I_{F25}$	forward current	$T_C = 25^{\circ}\text{C}$			12	A	
$I_{F80}$		$T_C = 80^{\circ}\text{C}$			8	A	
$V_F$	forward voltage	$I_F = 10\text{ A}; V_{GE} = 0\text{ V}$	$T_{VJ} = 25^{\circ}\text{C}$ $T_{VJ} = 125^{\circ}\text{C}$		2.5 2.6	2.9 V	V V
$I_R$	reverse current	$V_R = V_{RRM}$	$T_{VJ} = 25^{\circ}\text{C}$ $T_{VJ} = 125^{\circ}\text{C}$		0.5	0.5	mA mA
$Q_{rr}$	reverse recovery charge	$V_R = 600\text{ V}$ $di_F/dt = 200\text{ A}/\mu\text{s}$ $I_F = 5\text{ A}; V_{GE} = 0\text{ V}$	$T_{VJ} = 125^{\circ}\text{C}$		0.6		$\mu\text{C}$
$I_{RM}$	max. reverse recovery current				6		A
$t_{rr}$	reverse recovery time				350		ns
$E_{rec}$	reverse recovery energy				0.2		mJ
$R_{thJC}$	thermal resistance junction to case	(per diode)				3.4	K/W

 $T_C = 25^{\circ}\text{C}$  unless otherwise stated

**Input Rectifier Bridge D11 - D16**

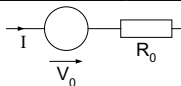
Symbol	Definitions	Conditions	Ratings			Unit
			min.	typ.	max.	
$V_{RRM}$	max. repetitive reverse voltage				1600	V
$I_{FAV}$	average forward current	sine 180°			37	A
$I_{DAVM}$	max. average DC output current	rect.; $d = 1/3$			105	A
$I_{FSM}$	max. forward surge current	$t = 10$ ms; sine 50 Hz			320	A
					280	A
$I^2t$	$I^2t$ value for fusing	$t = 10$ ms; sine 50 Hz			510	A <sup>2</sup> s
					390	A <sup>2</sup> s
$P_{tot}$	total power dissipation				114	W
$V_F$	forward voltage	$I_F = 50$ A		1.34	1.7	V
				1.34		V
$I_R$	reverse current	$V_R = V_{RRM}$			0.02	mA
				0.2		mA
$R_{thJC}$	thermal resistance junction to case	(per diode)			1.1	K/W

**Temperature Sensor NTC**

Symbol	Definitions	Conditions	Ratings			Unit
			min.	typ.	max.	
$R_{25}$	resistance		4.75	5.0	5.25	k $\Omega$
$B_{25/50}$				3375		K

**Module**

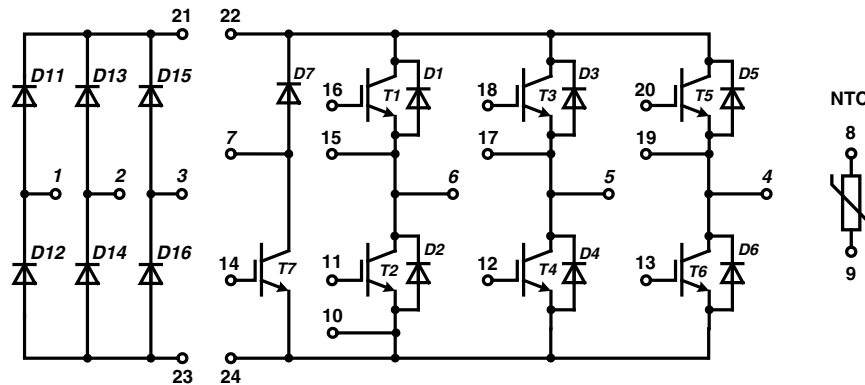
Symbol	Definitions	Conditions	Ratings			Unit
			min.	typ.	max.	
$T_{VJ}$	operating temperature		-40		125	°C
$T_{VJM}$	max. virtual junction temperature				150	°C
$T_{stg}$	storage temperature		-40		125	°C
$V_{ISOL}$	isolation voltage	$I_{ISOL} \leq 1$ mA; 50/60 Hz			2500	V~
<b>CTI</b>	comparative tracking index				-	
$M_d$	mounting torque (M5)		3		6	Nm
$d_S$	creep distance on surface		6			mm
$d_A$	strike distance through air		6			mm
$R_{pin-chip}$	resistance pin to chip			5		m $\Omega$
$R_{thCH}$	thermal resistance case to heatsink	with heatsink compound		0.02		K/W
<b>Weight</b>				180		g

**Equivalent Circuits for Simulation**


Symbol	Definitions	Conditions	Ratings			Unit
			min.	typ.	max.	
$V_0$	rectifier diode	D8 - D13			0.88	V
$R_0$					9	m $\Omega$
$V_0$	IGBT	T1 - T6			1.1	V
$R_0$					40	m $\Omega$
$V_0$	free wheeling diode	D1 - D6			1.2	V
$R_0$					27	m $\Omega$
$V_0$	IGBT	T7			1.1	V
$R_0$					86	m $\Omega$
$V_0$	free wheeling diode	D7			1.15	V
$R_0$					170	m $\Omega$

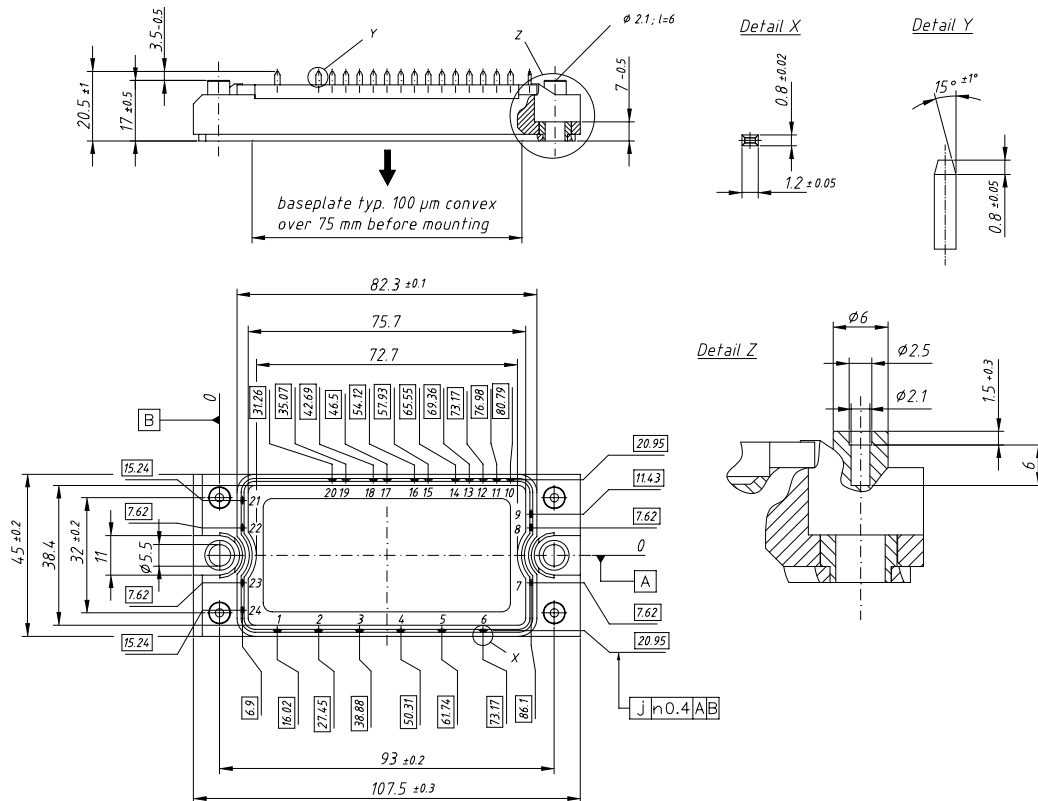
 $T_C = 25^\circ\text{C}$  unless otherwise stated

### Circuit Diagram

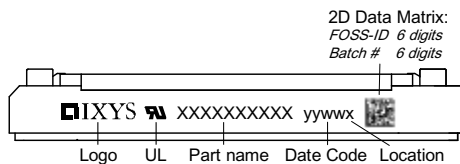


### Outline Drawing

Dimensions in mm (1 mm = 0.0394")



### Product Marking



2D Data Matrix:  
FOSS-ID 6 digits  
Batch # 6 digits

#### Part number

- M = Module
- I = IGBT
- X = XPT
- A = Standard
- 40 = Current Rating [A]
- WB = 6-Pack + 3~ Rectifier Bridge & Brake Unit
- 1200 = Reverse Voltage [V]
- T = NTC
- ED = E2-Pack

Ordering	Part Name	Marking on Product	Delivering Mode	Base Qty	Ordering Code
Standard	MIXA40WB1200 TED	MIXA40WB1200TED	Box	6	507497

## Inverter T1 - T6

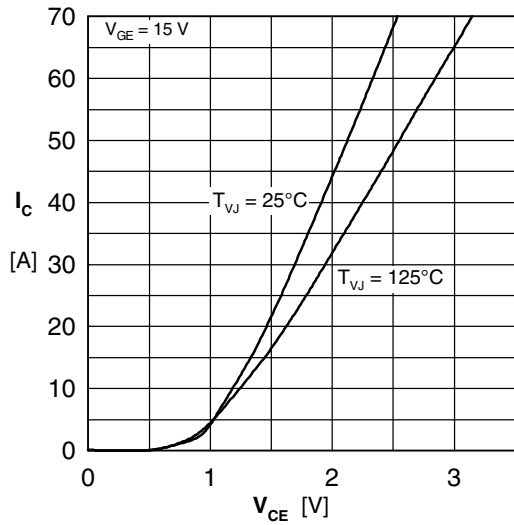


Fig. 1 Typ. output characteristics

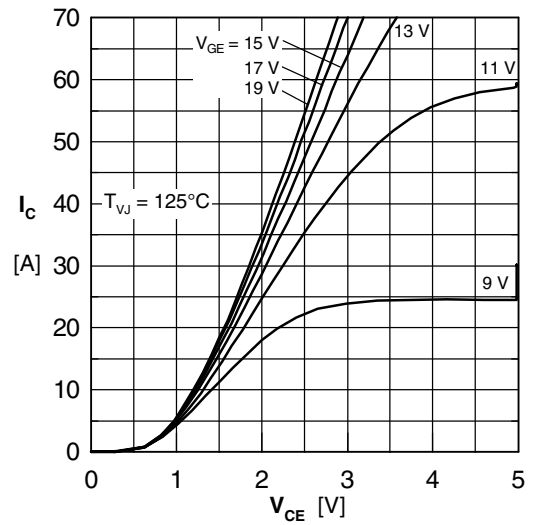


Fig. 2 Typ. output characteristics

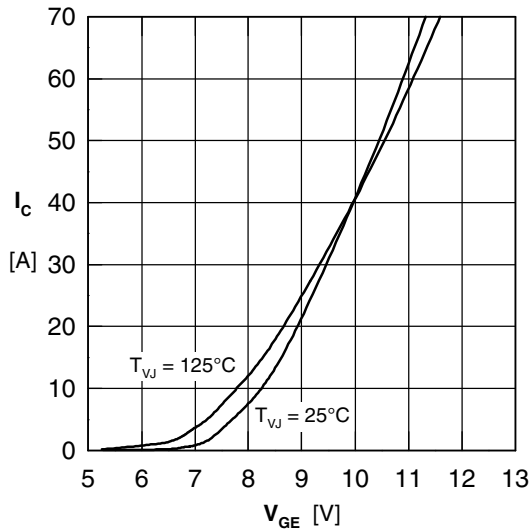


Fig. 3 Typ. transfer characteristics

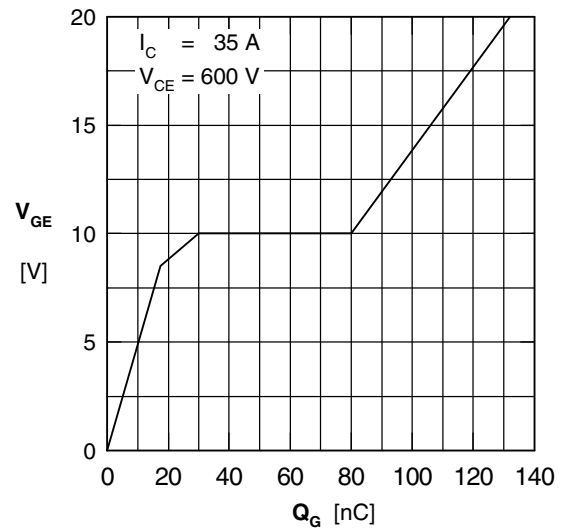


Fig. 4 Typ. turn-on gate charge

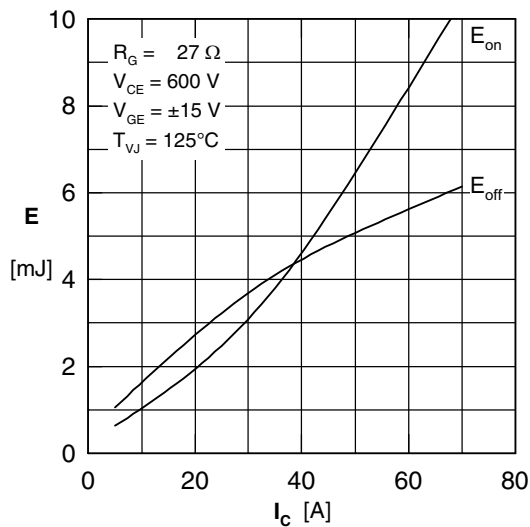


Fig. 5 Typ. switching energy vs. collector current

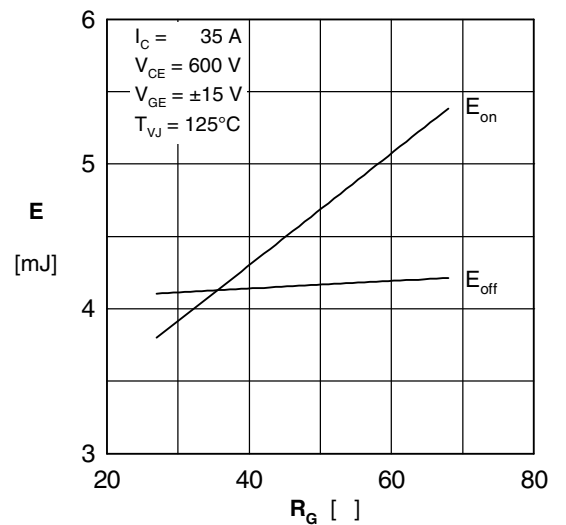


Fig. 6 Typ. switching energy vs. gate resistance

## Inverter D1 - D6

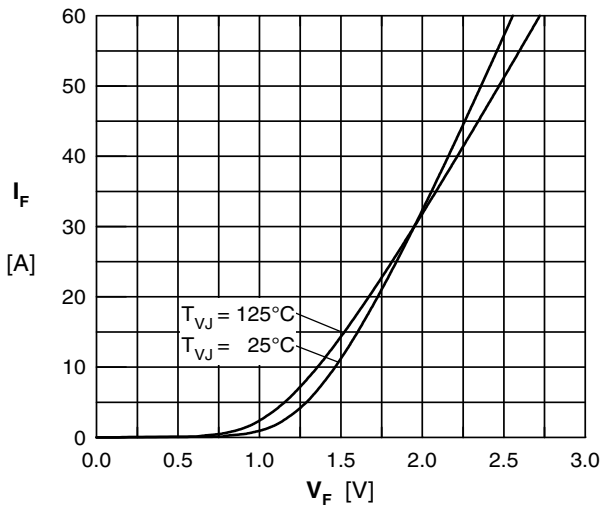


Fig. 7 Typ. Forward current versus  $V_F$

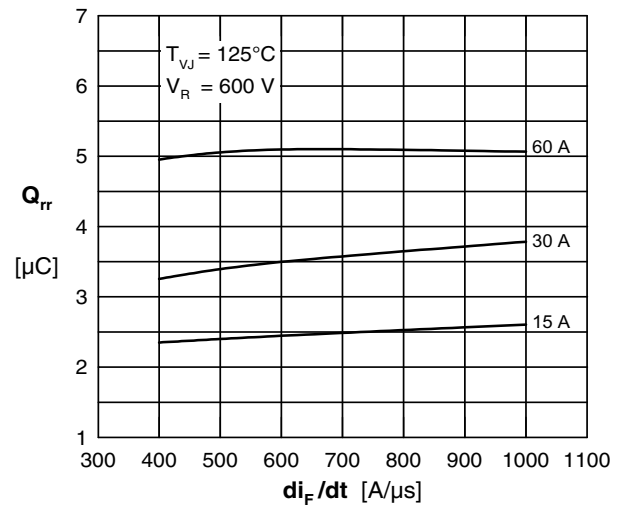


Fig. 8 Typ. reverse recov.charge  $Q_{rr}$  vs.  $di/dt$

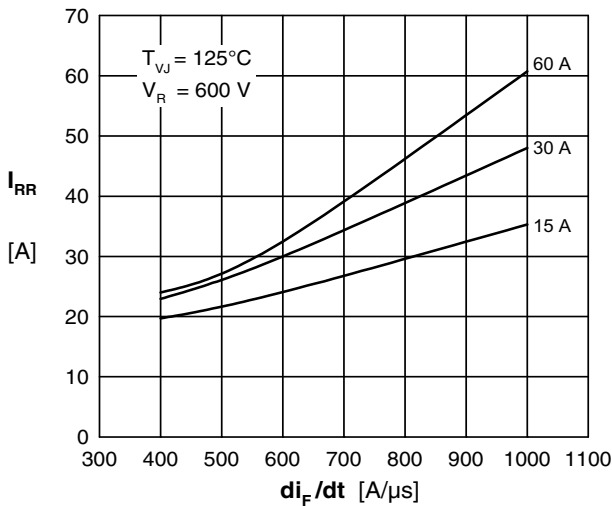


Fig. 9 Typ. peak reverse current  $I_{RM}$  vs.  $di/dt$

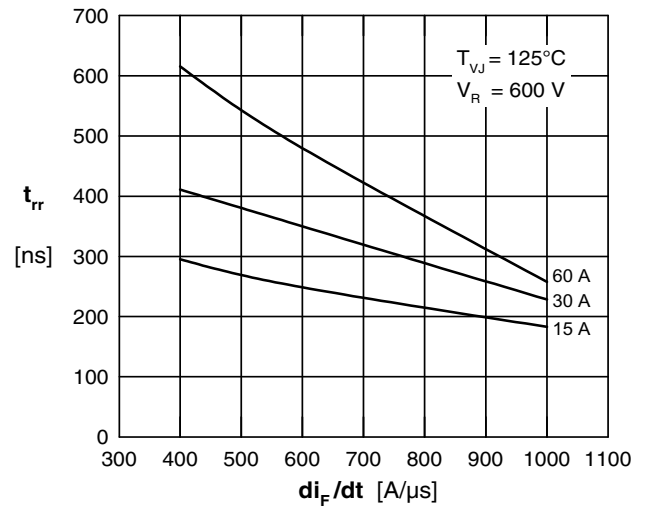


Fig. 10 Typ. recovery time  $t_{rr}$  versus  $di/dt$

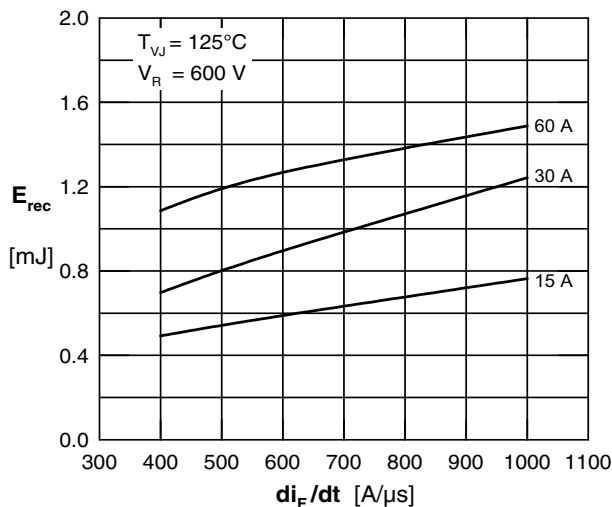


Fig. 5 Typ. recovery energy  $E_{rec}$  versus  $di/dt$

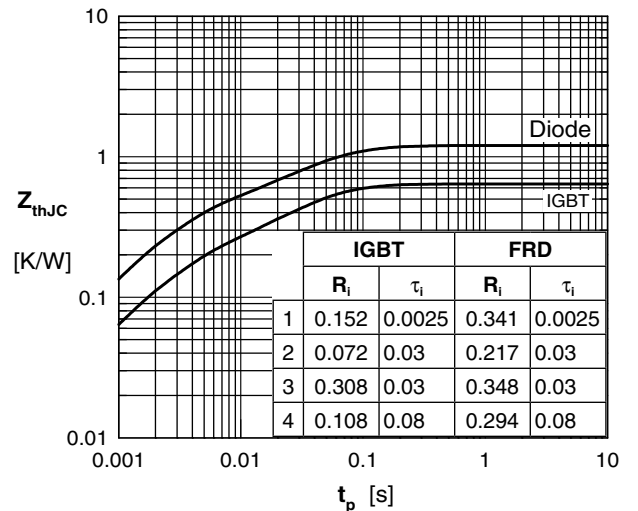


Fig. 12 Typ. transient thermal impedance

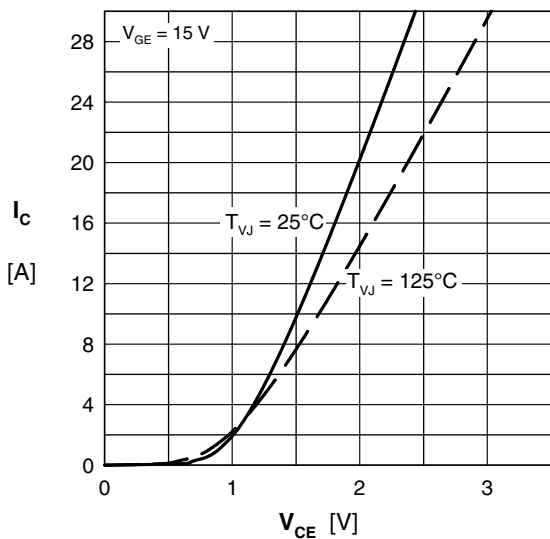
**Brake T7 & D7**


Fig. 13 Typ. output characteristics

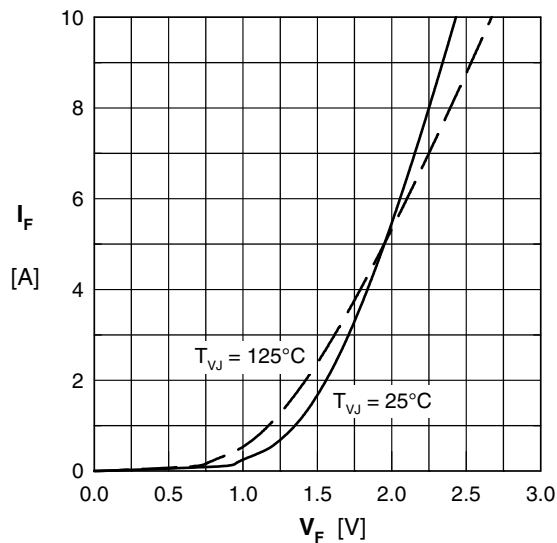


Fig. 14 Typ. forward characteristics

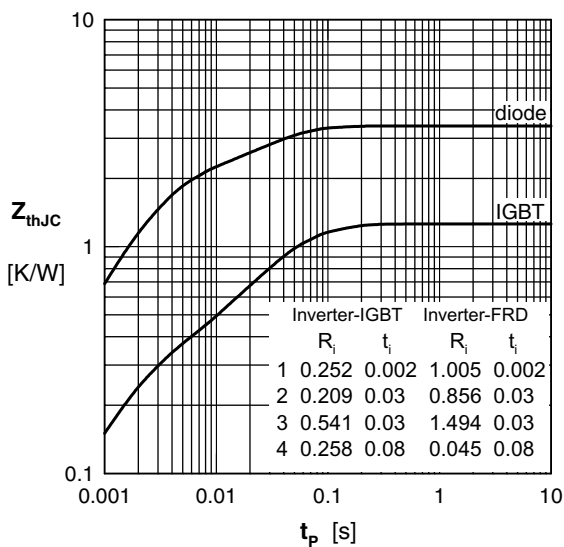


Fig. 15 Typ. transient thermal impedance

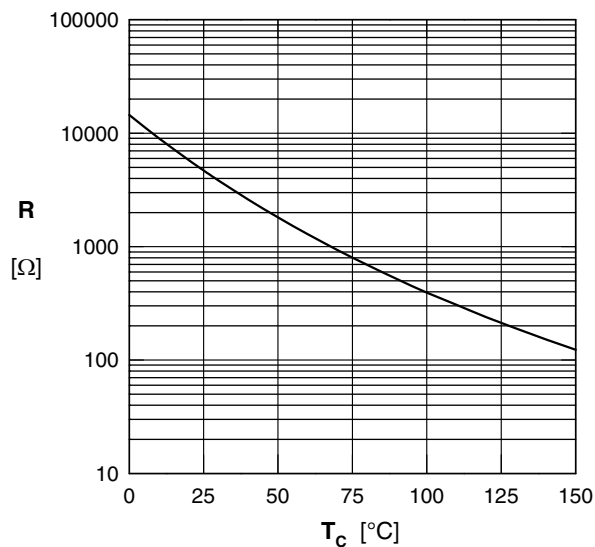


Fig. 16 Typ. NTC resistance vs. temperature