

DO NOT SCALE FROM THIS PRINT

DESIGNED & DIMENSIONED IN INCHES[MILLIMETERS]

PRFM0-J-C-EE-047A-BD

SERIES -M0: SMPM
 GENDER -J: JACK
 TYPE -C: CABLE
 FINISH -EE: 50µ" EXTRA HEAVY GOLD CENTER CONTACT, 50µ" EXTRA HEAVY GOLD OUTER CONTACT
 TERMINATION -D: DIRECT SOLDER
 ORIENTATION -B: BULKHEAD
 CABLE TYPE -047A: TEMP FLEX 1000671047

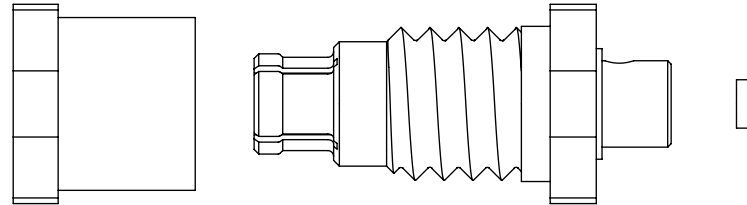
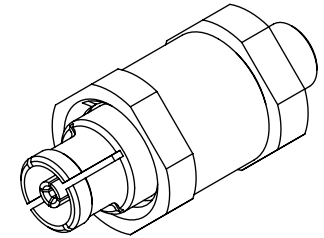
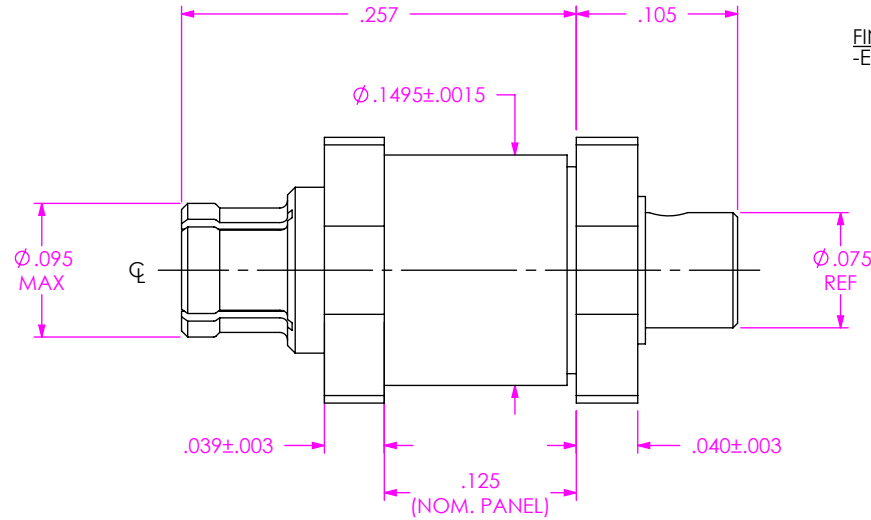

EXPLODED VIEW
 NOT TO SCALE
 (FOR CLARITY ONLY)

- NOTES:
- MATERIAL:
 BODY, SHROUD: STAINLESS STEEL.
 DIELECTRIC BEAD: PEI.
 SOCKET: BERYLLIUM COPPER.
 BACK BODY: BRASS.
 - FINISH:
 BODY, SHROUD: PASSIVATED.
 SOCKET, BACK BODY: GOLD OVER NICKEL PLATE, 50 µIN MIN GOLD OVER 50 µIN MIN NICKEL.
 - PERFORMANCE:
 IMPEDANCE: 50 Ω
 FREQUENCY: DC TO 65 GHz
 VSWR: 1.18: 1 MAXIMUM
 INSERTION LOSS: 0.04 x √f(GHz)
 DWV: 750 Vrms
 - PCI P/N: 3757.

UNLESS OTHERWISE SPECIFIED, DIMENSIONS ARE IN INCHES. TOLERANCES ARE: DECIMALS .XX: ±.01 .XXX: ±.002 .XXXX: ±.0005 ANGLES 1°	* PROPRIETARY NOTE * THIS DOCUMENT CONTAINS CONFIDENTIAL AND PROPRIETARY INFORMATION AND ALL DESIGN, MANUFACTURING, REPRODUCTION, USE, PATENT RIGHTS AND SALES RIGHTS ARE EXPRESSLY RESERVED BY SAMTEC, INC. THIS DOCUMENT SHALL NOT BE DISCLOSED, IN WHOLE OR PART, TO ANY UNAUTHORIZED PERSON OR ENTITY NOR REPRODUCED, TRANSFERRED OR INCORPORATED IN ANY OTHER PROJECT IN ANY MANNER WITHOUT THE EXPRESS WRITTEN CONSENT OF SAMTEC, INC.	 520 PARK EAST BLVD., NEW ALBANY, IN 47150 PHONE: 812-944-6733 FAX: 812-948-5047 e-Mail info@SAMTEC.com code 55322
DESCRIPTION: SMPM SOCKET BULKHEAD DIRECT SOLDER FOR TEMP-FLEX 1000671047		DWG. NO. PRFM0-J-C-EE-047A-BD
BY: SHERRY W 4/13/2019		SHEET 1 OF 2

CABLE APPLICATION VIEWS

1A. TRIM CABLE TO EXPOSE CENTER CONDUCTOR AND BRAID AS SHOWN
 1B. POINT CENTER CONDUCTOR AS SHOWN

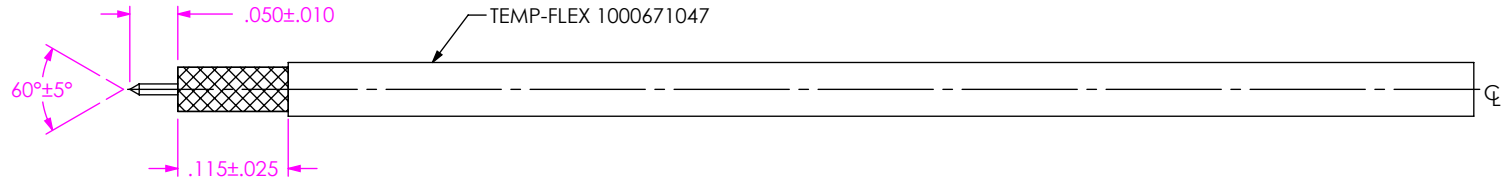

IN-PROCESS VIEW 1

2A. SLIDE DIELECTRIC STOP OVER CABLE CENTER CONDUCTOR AGAINST DIELECTRIC CORE.

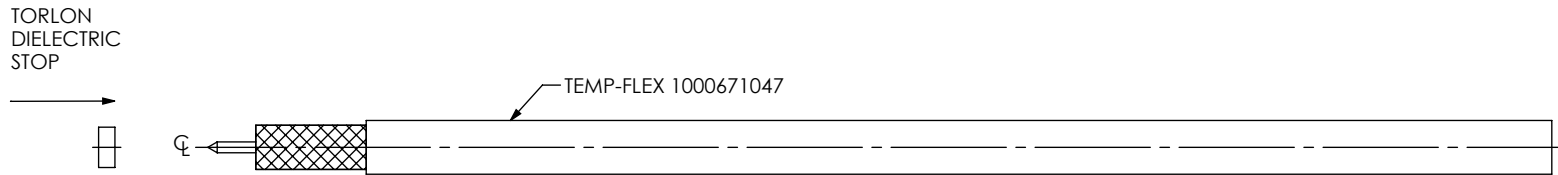

IN-PROCESS VIEW 2

3A. INSERT CABLE / CONTACT SUB-ASSEMBLY INTO CONNECTOR UNTIL SEATED THEN SOLDER WHERE SHOWN.

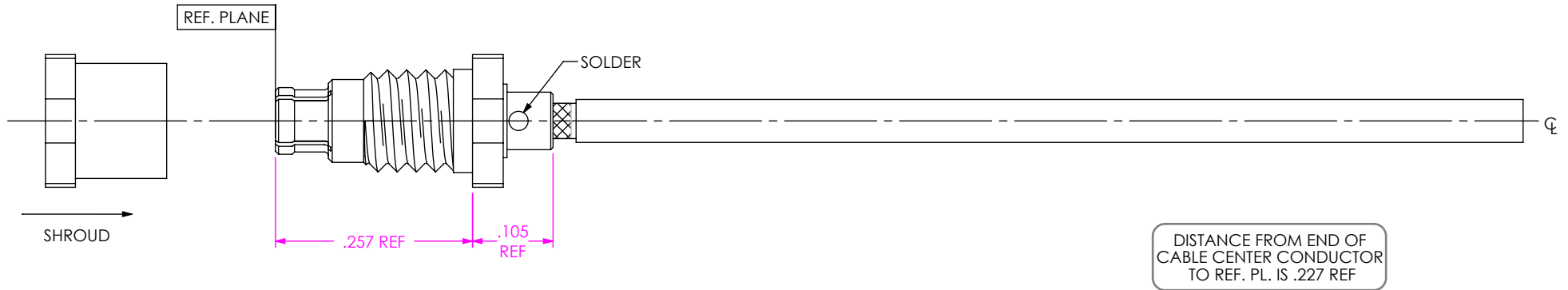

IN-PROCESS VIEW 3

PROPRIETARY NOTE
 THIS DOCUMENT CONTAINS CONFIDENTIAL AND PROPRIETARY INFORMATION AND ALL DESIGN, MANUFACTURING, REPRODUCTION, USE, PATENT RIGHTS AND SALES RIGHTS ARE EXPRESSLY RESERVED BY SAMTEC, INC. THIS DOCUMENT SHALL NOT BE DISCLOSED, IN WHOLE OR PART, TO ANY UNAUTHORIZED PERSON OR ENTITY NOR REPRODUCED, TRANSFERRED OR INCORPORATED IN ANY OTHER PROJECT IN ANY MANNER WITHOUT THE EXPRESS WRITTEN CONSENT OF SAMTEC, INC.



520 PARK EAST BLVD, NEW ALBANY, IN 47150
 PHONE: 812-944-6733 FAX: 812-948-5047
 e-Mail info@SAMTEC.com code 55322

DO NOT SCALE DRAWING
 SHEET SCALE: 5:1

DESCRIPTION:
 SMPM SOCKET BULKHEAD DIRECT SOLDER FOR TEMP-FLEX 1000671047

DWG. NO.
PRFM0-J-C-EE-047A-BD

BY: SHERRY W 4/13/2019 SHEET 2 OF 2