

For the electronic measurement of current: DC, AC, pulsed..., with galvanic separation between the primary and the secondary circuit.

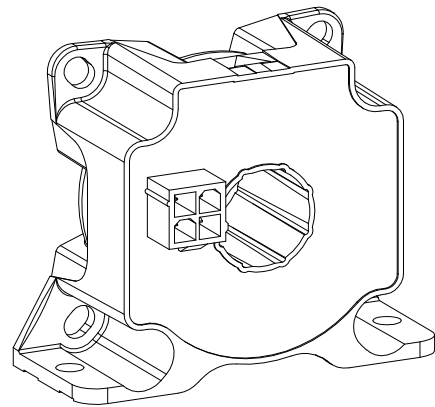

Features

- Bipolar and insulated current measurement
- Current output
- Closed loop (compensated) current transducer
- Panel mounting.

Special Features

- $I_{PN} = 100 \text{ A}$
- $I_{PM} = 0 \dots \pm 200 \text{ A}$
- $N_s = 1000$ turns
- Connection to secondary circuit on MOLEX Mini-Fit Jr. 5566 (gold plated).

Advantages

- High accuracy
- Very low offset drift over temperature.

Applications

- Single or three phase inverters
- Propulsion and braking choppers
- Propulsion converters
- Auxiliary converters
- Battery chargers
- Substations.

Standards

- EN 50121-3-2: 2015
- EN 50155: 2017
- IEC 62497-1: 2010
- UL 508: 2013.

Application Domain

- Railway (fixed installations and onboard).

Absolute maximum ratings

Parameter	Symbol	Unit	Value
Maximum supply voltage (working) (-50 °C ... 85 °C)	$\pm U_{C \max}$	V	± 15.75
Maximum primary conductor temperature	$T_{B \max}$	°C	100
Maximum steady state primary current (-50 °C ... 85 °C)	$I_{P N \max}$	A	100

Stresses above these ratings may cause permanent damage.
Exposure to absolute maximum ratings for extended periods may degrade reliability.

UL 508: Ratings and assumptions of certification

File # E189713 Volume: 2 Section: 9

Standards

- USR indicates investigation to the Standard for Industrial Control Equipment UL 508.
- CNR indicates investigation to the Canadian standard for Industrial Control Equipment CSA C22.2 No. 14-13.

Ratings

Parameter	Unit	Value
Primary involved potential	V AC/DC	1500
Maximum surrounding air temperature	°C	85
Primary current	A	0 ... 100
Secondary supply voltage	V DC	0 ... ± 15.75
Secondary current	mA	0 ... 100

Conditions of acceptability

When installed in the end-use equipment, with primary feedthrough potential involved of 1500 V AC/DC, consideration shall be given to the following:

- 1 - *These products must be mounted in a suitable end-use enclosure.*
- 2 - *The secondary pin terminals have not been evaluated for field wiring.*
- 3 - *Low voltage control circuit shall be supplied by an isolating source (such as transformer, optical isolator, limiting impedance or electro-mechanical relay).*
- 4 - *Based on the temperature test performed on LF 210-S series, the primary bar or conductor shall not exceed 100 °C in the end use application.*
- 5 - *LF 210-S series shall be used in a pollution degree 2.*

Marking

Only those products bearing the UL or UR Mark should be considered to be Listed or Recognized and covered under UL's Follow-Up Service. Always look for the Mark on the product.

Insulation coordination

Parameter	Symbol	Unit	Value	Comment
RMS voltage for AC insulation test, 50 Hz, 1 min	U_d	kV	3.5	Type test
Impulse withstand voltage 1.2/50 μ s	U_{Ni}	kV	7.6	
Clearance (pri. - sec.)	d_{Cl}	mm	7.5	Shortest distance through air
Creepage distance (pri. - sec.)	d_{Cp}	mm	20.2	Shortest path along device body
Application example Rated insulation RMS voltage	U_{Nm}	V	920	Basic insulation (interpolated) according to IEC 62497-1 CAT III, PD2
Application example Rated insulation RMS voltage	U_{Nm}	V	413	Reinforced insulation (interpolated) according to IEC 62497-1 CAT III, PD2
Case material	-	-	V0	According to UL 94
Comparative tracking index	CTI		600	

Environmental and mechanical characteristics

Parameter	Symbol	Unit	Min	Typ	Max	Comment
Ambient operating temperature	T_A	°C	-40		85	
Ambient storage temperature	T_S	°C	-50		85	
Equipment operating temperature class						EN 50155: OT6
Switch-on extended operating temperature class						EN 50155: ST0
Rapid temperature variation class						EN 50155: H2
Conformal coating type						EN 50155: NA
Mass	m	g		75		

RAMS data

Parameter	Symbol	Unit	Min	Typ	Max
Useful life class					EN 50155: L4
Mean failure rate	$\bar{\lambda}$	h^{-1}		1/1984154	According to IEC 62380: 2004 $T_A = 40$ °C ON: 24 h/day ON/OFF: 365 cycles/year $U_C = \pm 15$ V, $I_p = 100$ A RMS

Electrical data

At $T_A = 25\text{ °C}$, $\pm U_C = \pm 15\text{ V}$, $R_M = 1\ \Omega$, unless otherwise noted.

Lines with a * in the conditions column apply over the $-40 \dots 85\text{ °C}$ ambient temperature range.

Parameter	Symbol	Unit	Min	Typ	Max	Conditions
Primary nominal RMS current	I_{PN}	A			100	*
Primary current, measuring range	I_{PM}	A	-200		200	*
Measuring resistance	R_M	Ω	0 ¹⁾			* Max value of R_M is given in Figure 1
Secondary nominal RMS current	I_{SN}	A	-0.1		0.1	*
Resistance of secondary winding	R_S	Ω			8.5	$R_S(T_A) = R_S \times (1 + 0.004 \times (T_A + \Delta\text{temp} - 25))$ Estimated temperature increase @ I_{PN} is $\Delta\text{temp} = 15\text{ °C}$
Secondary current	I_S	A	-0.20		0.20	*
Number of secondary turns	N_S			1000		
Nominal sensitivity	S_N	mA/A		1		
Supply voltage	$\pm U_C$	V	± 11.4		± 15.75	*
Current consumption	I_C	mA		$33 + I_S$ $35 + I_S$		$\pm U_C = \pm 12\text{ V}$ $\pm U_C = \pm 15\text{ V}$
Inrush current						NA (EN 50155)
Interruptions on power supply voltage class						NA (EN 50155)
Supply change-over class						NA (EN 50155)
Offset current, referred to primary	I_O	A	-0.15		0.15	
Temperature variation of I_O , referred to primary	I_{OT}	A	-0.2		0.2	*
Magnetic offset current (@ $3 \times I_{PN}$), referred to primary	I_{OM}	A		± 0.2		
Sensitivity error	ε_S	%	-0.15		0.15	*
Linearity error	ε_L	% of I_{PN}	-0.05		0.05	*
Total error at I_{PN}	ε_{tot}	% of I_{PN}	-0.2 -0.2		0.2 0.2	* 25 ... 85 °C -40 ... 85 °C
RMS noise current referred to primary	I_{no}	mA		20		1 Hz to 100 kHz (see Figure 4)
Delay time to 10 % of the final output value for I_{PN} step	t_{D10}	μs		< 0.5		0 to 200 A, 75 A/ μs , $R_M = 10\ \Omega$
Delay time to 90 % of the final output value for I_{PN} step	t_{D90}	μs		< 0.5		0 to 200 A, 75 A/ μs , $R_M = 10\ \Omega$ (see Figure 2)
Frequency bandwidth	BW	kHz		100		$R_M = 50\ \Omega$; -3 dB

Note: ¹⁾ With ± 15 as power supply. Other values of minimum values according to conditions of use are given in Figure 1.

Definition of typical, minimum and maximum values

Minimum and maximum values for specified limiting and safety conditions have to be understood as such as well as values shown in "typical" graphs. On the other hand, measured values are part of a statistical distribution that can be specified by an interval with upper and lower limits and a probability for measured values to lie within this interval. Unless otherwise stated (e.g. "100 % tested"), the LEM definition for such intervals designated with "min" and "max" is that the probability for values of samples to lie in this interval is 99.73 %. For a normal (Gaussian) distribution, this corresponds to an interval between -3 sigma and +3 sigma. If "typical" values are not obviously mean or average values, those values are defined to delimit intervals with a probability of 68.27 %, corresponding to an interval between -sigma and +sigma for a normal distribution.

Typical, minimum and maximum values are determined during the initial characterization of the product.

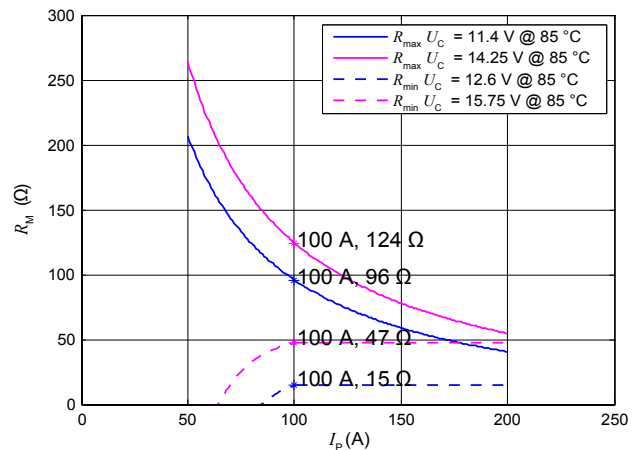
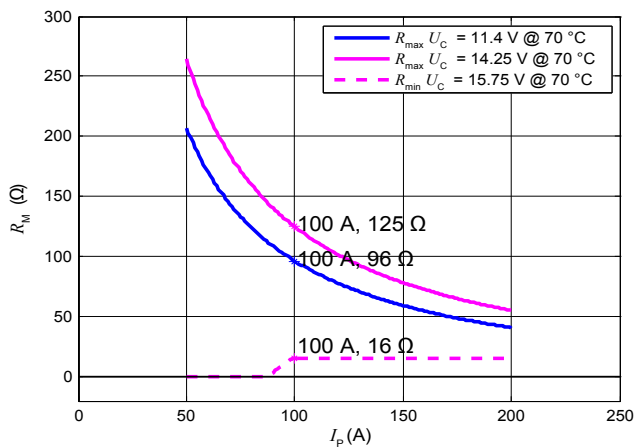

Figure 1: Maximum measuring resistance

$$R_{M \max} = N_S \times \frac{U_{C \min} - 0.3 \text{ V}}{I_p} - R_{S \max} - 4.1 \Omega$$

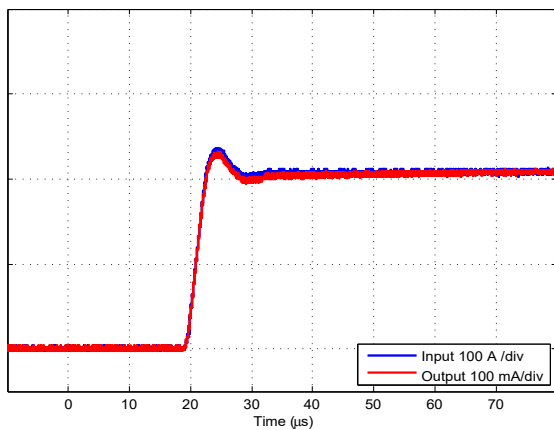

Figure 2: Typical delay time (0 to 200 A, 75 A/μs, with $R_M = 10 \Omega$)

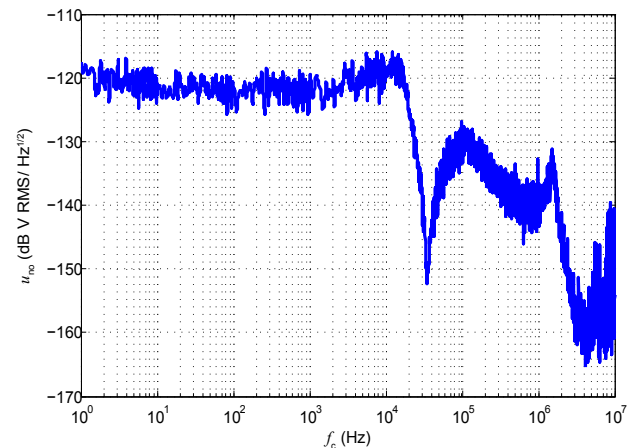

Figure 3: Typical noise voltage spectral density referred to primary u_{no} with $R_M = 10 \Omega$

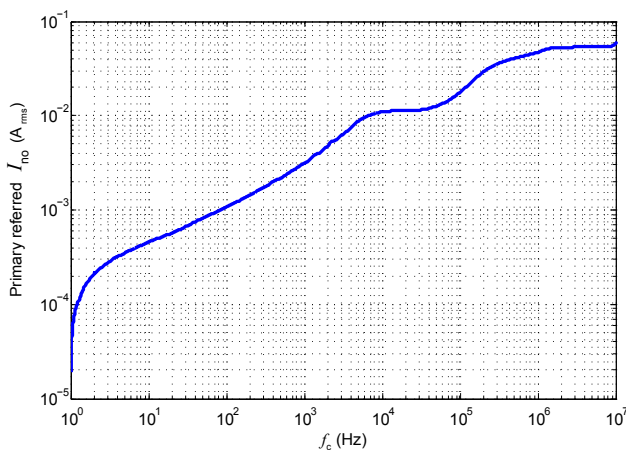

Figure 4: Typical RMS noise current referred to primary with $R_M = 10 \Omega$

To calculate the noise in a frequency band f_1 to f_2 , the formula is:

$$I_{no}(f_1 \dots f_2) = \sqrt{I_{no}(f_2)^2 - I_{no}(f_1)^2}$$

with $I_{no}(f)$ read from figure 4 (typical, RMS value).

Example:

What is the noise from 10^3 to 10^6 Hz?

Figure 4 gives $I_{no}(10^3 \text{ Hz}) = 3 \text{ mA}$

and $I_{no}(10^6 \text{ Hz}) = 50 \text{ mA}$.

The output RMS noise current is therefore:

$$\sqrt{(50 \times 10^{-3})^2 - (3 \times 10^{-3})^2} = 50 \text{ mA referred to primary}$$

Typical performance characteristics continued

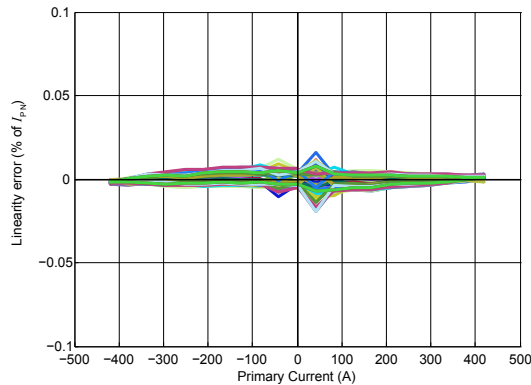

Figure 5: Linearity

Performance parameters definition

Sensitivity and linearity

To measure sensitivity and linearity, the primary current (DC) is cycled from 0 to I_{PM} , then to $-I_{PM}$ and back to 0 (equally spaced $I_{PM}/10$ steps).

The sensitivity S is defined as the slope of the linear regression line for a cycle between $\pm I_{PM}$.

The linearity error ϵ_L is the maximum positive or negative difference between the measured points and the linear regression line, expressed in % of the maximum measured value.

Magnetic offset

The magnetic offset I_{OM} is the change of offset after a given current has been applied to the input. It is included in the linearity error as long as the transducer remains in its measuring range.

Electrical offset

The electrical offset current I_{OE} is the residual output current when the input current is zero.

Total error

The total error ϵ_{tot} is the error at $\pm I_{PN}$, relative to the rated value I_{PN} .

It includes all errors mentioned above.

Delay times

The delay time t_{D10} @ 10 % and the delay time t_{D90} @ 90 % with respect to the primary are shown in the next figure.

Both slightly depend on the primary current di/dt .

They are measured at nominal current.

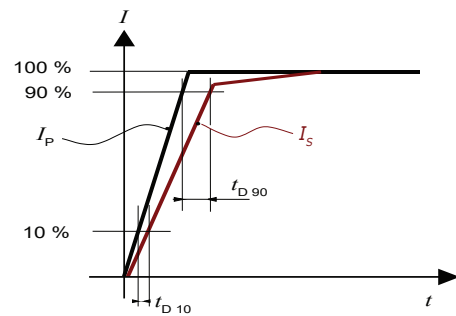
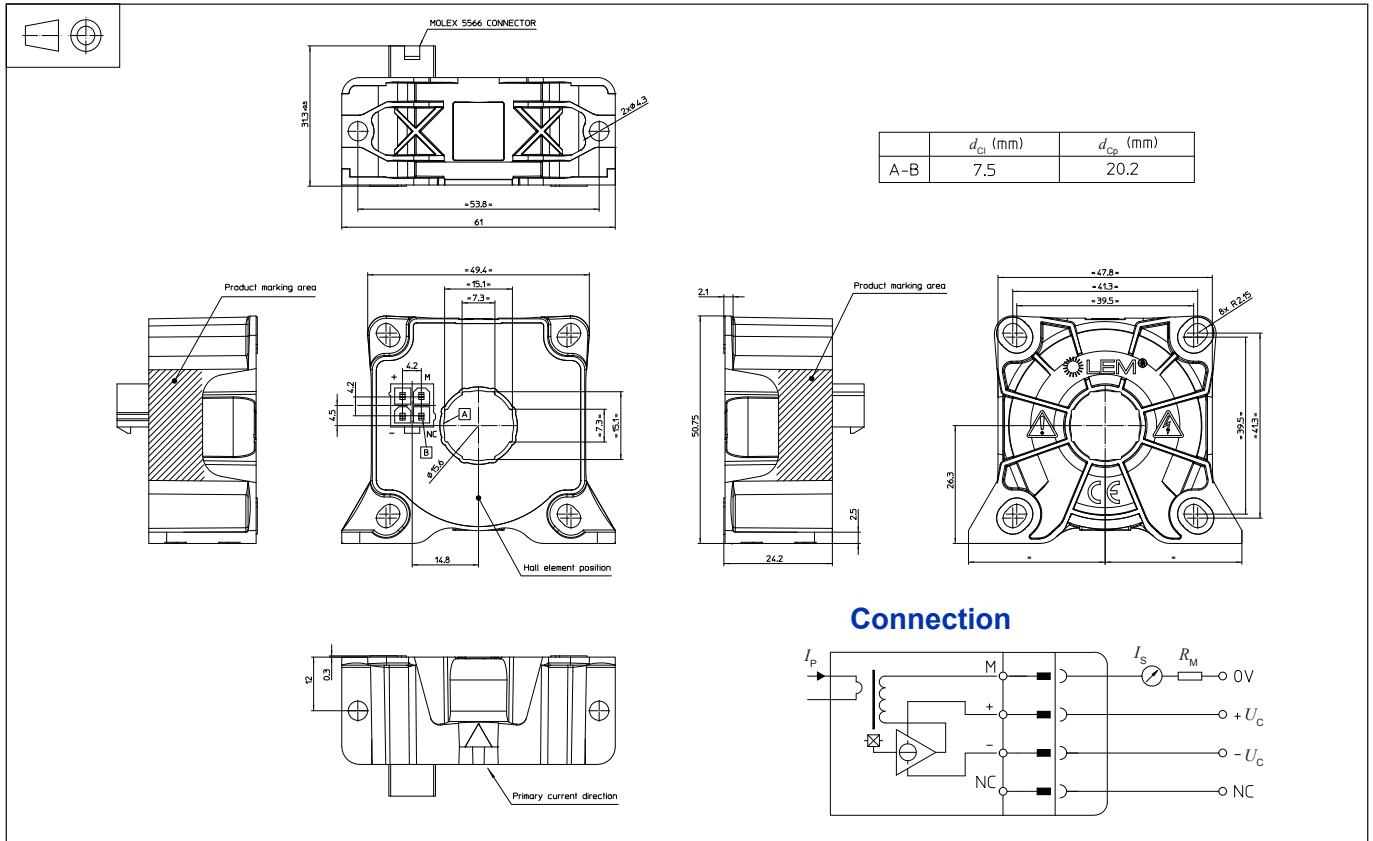

Figure 6: t_{D10} (delay time @ 10 %) and t_{D90} (delay time @ 90 %)



Mechanical characteristics

- General tolerance ± 0.3 mm
- Transducer fastening
Vertical position
2 holes $\varnothing 4.3$ mm
2 M4 steel screws
Recommended fastening torque 2.1 N·m (± 10 %)
- Transducer fastening
Horizontal position
4 holes $\varnothing 4.3$ mm
4 M4 steel screws
Recommended fastening torque 2.1 N·m (± 10 %)
- Connection of secondary MOLEX 5566
- Primary through hole $\varnothing 15.59$ mm

Remarks

- I_s is positive when I_p flows in the direction of arrow.
- The secondary cables also have to be routed together all the way.
- Installation of the transducer is to be done without primary current or secondary voltage present.
- Maximum temperature of primary conductor: see page 2.
- Installation of the transducer must be done unless otherwise specified on the datasheet, according to LEM Transducer Generic Mounting Rules. Please refer to LEM document N°ANE120504 available on our Web site: <https://www.lem.com/en/file/3137/download>.

Safety

This transducer must be used in limited-energy secondary circuits according to IEC 61010-1.



This transducer must be used in electric/electronic equipment with respect to applicable standards and safety requirements in accordance with the manufacturer's operating instructions.



Caution, risk of electrical shock

When operating the transducer, certain parts of the module can carry hazardous voltage (e.g. primary connection, power supply). Ignoring this warning can lead to injury and/or cause serious damage.

This transducer is a build-in device, whose conducting parts must be inaccessible after installation. A protective housing or additional shield could be used. Main supply must be able to be disconnected.

Note: Additional information available on request.