

ES2A-AT THRU ES2J-AT

SURFACE MOUNT SUPERFAST RECOVERY RECTIFIERS

Forward Current-2A

Reverse Voltage-50V to 600V

FEATURES

- ◆ For surface mount applications
- ◆ Glass passivated chip junction
- ◆ Low profile package
- ◆ Superfast reverse recovery time
- ◆ Lead free in comply with EU RoHS 2011/65/EU directives

MECHANICAL DATA

- ◆ Case: SMA
- ◆ Terminals: Solderable per MIL-STD- 750, Method 2026
- ◆ 5 ddfcl 'K YJ[\ h '\$\$)) # '\$\$&cn

PINNING

PIN	DESCRIPTION
1	Cathode
2	Anode

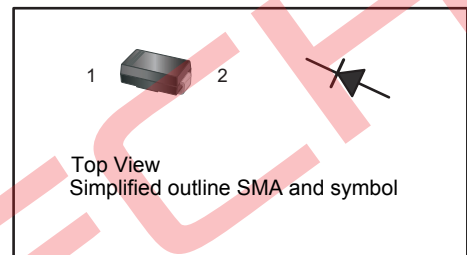

MAXIMUM RATINGS AND ELECTRICAL CHARACTERISTICS

Ratings at 25°C ambient temperature unless otherwise specified.

Single phase half-wave 60 Hz, resistive or inductive load, for capacitive load current derating by 20 %.

PARAMETER	SYMBOL	ES&A -AT	ES&B -AT	ES&C -AT	ES&D -AT	ES&E -AT	ES&G -AT	ES&J -AT	UNIT	
Maximum Repetitive Peak Reverse Voltage	V_{RRM}	50	100	150	200	300	400	600	V	
Maximum RMS Voltage	V_{RMS}	35	70	105	140	210	280	420	V	
Maximum DC Blocking Voltage	V_{DC}	50	100	150	200	300	400	600	V	
Maximum Average Forward Rectified Current at $T_C=125^\circ\text{C}$	$I_{F(AV)}$	2							A	
Peak Forward Surge Current	I_{FSM}	50							A	
Maximum Forward Voltage at 2.0 A	V_F	1			1.25		1.6		V	
Maximum DC Reverse Current at Rated DC Blocking Voltage $T_A=25^\circ\text{C}$ $T_A=125^\circ\text{C}$	I_R	5				100				μA
Typical Junction Capacitance at $V_R=4\text{V}, f=1\text{MHz}$	C_J	40							pF	
Maximum Reverse Recovery Time (Note1)	T_{rr}	35							nS	
Typical Thermal Resistance (Note2)	$R_{\theta JA}$	60							$^\circ\text{C}/\text{W}$	
Operating and Storage Temperature Range	T_J, T_{STG}	-55 to +150							$^\circ\text{C}$	

Notes: 1. Measured at with $I_F=0.5\text{A}$, $I_R=1\text{A}$, $I_{rr}=0.25\text{A}$.

2. P.C.B. mounted with 1.0" X 1.0" (2.54 X2.54 cm) copper pad areas.

ES2A-AT THRU ES2J-AT

RATINGS AND CHARACTERISTIC CURVES

Fig.1 Reverse Recovery Time Characteristic And Test Circuit Diagram

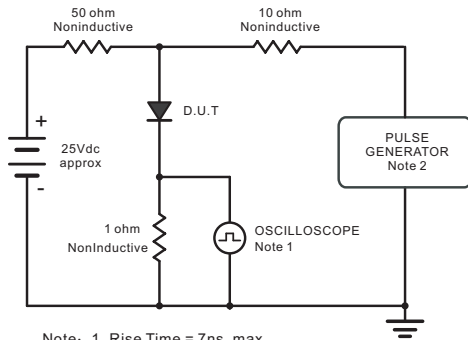

Note: 1. Rise Time = 7ns, max.
Input Impedance = 1megohm, 22pF.
2. Rise Time = 10ns, max.
Source Impedance = 50 ohms.

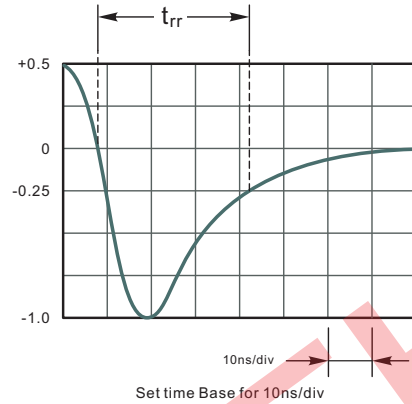

Fig.2 Maximum Average Forward Current Rating

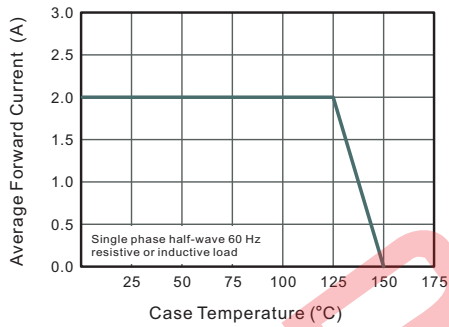

Fig.3 Typical Reverse Characteristics

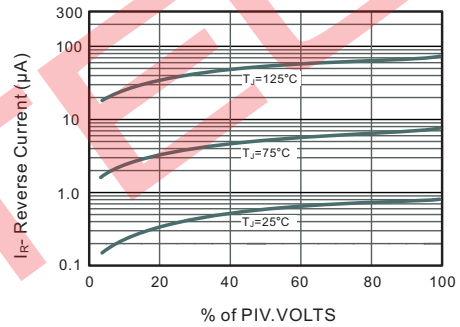

Fig.4 Typical Forward Characteristics

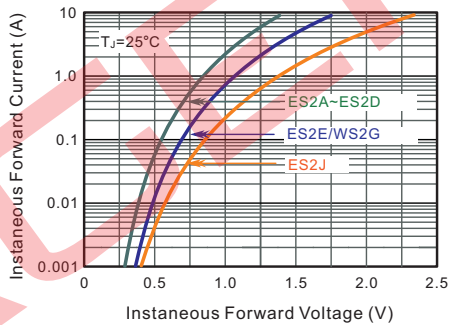

Fig.5 Typical Junction Capacitance

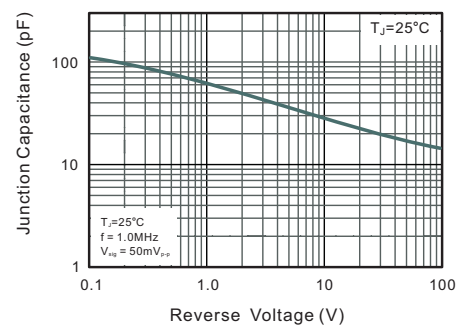
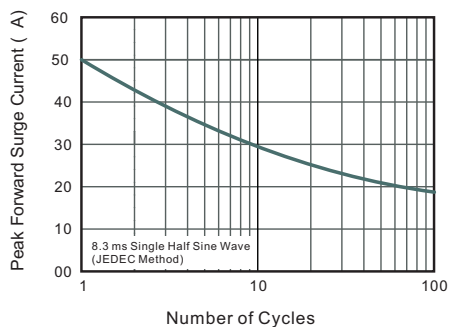

Fig.6 Maximum Non-Repetitive Peak Forward Surge Current



ES2A-AT THRU ES2J-AT

PACKAGE OUTLINE

SMA

