

产品承认书

SPECIFICATION FOR APPROVAL

CUSTOMER:

CUSTOMER P/N:

CND-TEK P/N. :

B1201D

DESCRIPTION:

10/100 BASE-T MAGNETICS MODULES

REF NO:

QTC-001

REV/NO:

V1.02

DATE:

2015/03/02

ATTACHMENT:

■ SPECIFICATION

■ SAMPLE Q'TY OF SAMPLES PCS

	√	CUSTOMER'S SIGNATURE	REMARK
FULL APPROVED			
CONDITIONAL APPROVED			
REJECTED			

CND-TEK

B1201D

10/100 BASE-T MAGNETICS MODULES

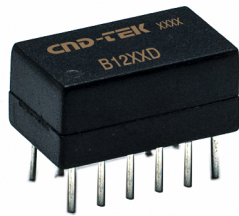

V1.0.2
Feb 2, 2015

CND-TEK

深圳磁联达电子有限公司

Shenzhen CND-TEK Electronics Co.,Ltd

公司地址: 深圳市南山区西丽镇街道百旺社区牛城村牛城路221号505

TEL: 86-755-29016433 FAX:86- 755-27652977

Email: sales2@cd-tek.com

Http: //www.cd-tek.com

1. FEATURES:

- 1.1 Compatible with various 10/100 Base-TX transceiver requiring 1:1 transmit and receive turns ratio
- 1.2 Compliant with IEEE 802.3 standard including baseline wander compensation specification of 350uH OCL when Biased at 8mA from 0°C to 70°C
- 1.3 Single channel interface for 10/100Mbps Ethernet applications with CMC's tuned to Enhance EMC system performance
- 1.4 Available in Through Hole package.
- 1.5 Operating Temperature range: 0°C TO +70°C
- 1.6 Storage temperature range: -40°C TO +85°C

2. DIMENSIONS & MARKING

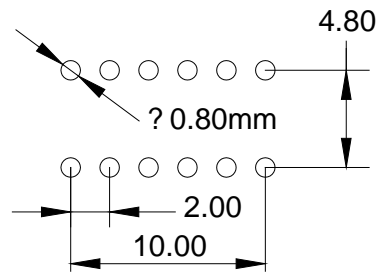
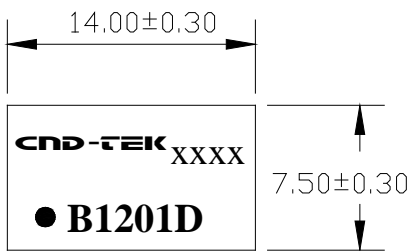

Recommended Land Pattern

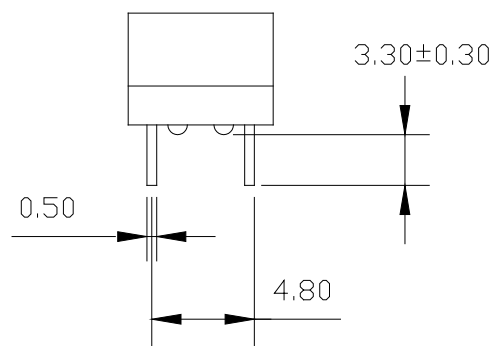
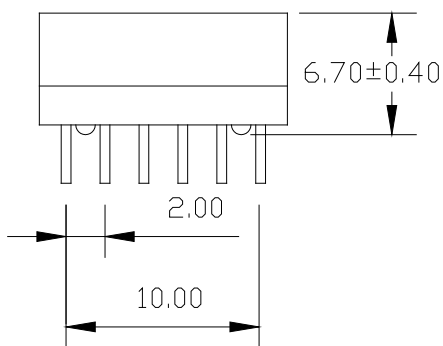

Note: 1、 Dimension: mm

2、 Unless otherwise specified, all tolerances are: ± 0.05 mm

3. SCHEMATICS:

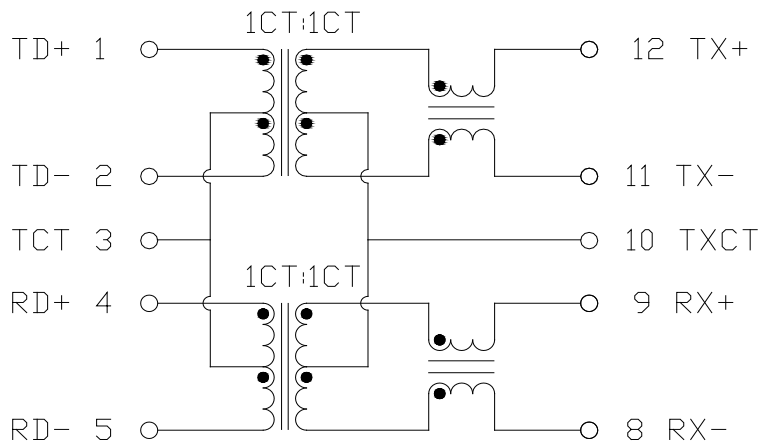

4. ELECTRICAL SPECIFICATIONS @25°C

4.1 OCL :	350 μ H Min. @ 100 KHz, 100mV with 8mA DC Bias
4.2 Leakage Inductance:	0.5 μ H Max. @ 100KHz, 0.2V
4.3 Cw/w:	56 pF Max. @ 100KHz, 0.2V
4.4 DCR:	1.20 Ω Max.
4.5 Turns Ratio(\pm5%):	1CT:1CT(TX), 1CT:1CT(RX)
4.6 Polarity:	1-12, 4-9 In-Phase
4.7 Insertion Loss:	-1.1 dB Max. @ 1-100MHz
4.8 Return Loss:	-18 dB Min. @ 0.5-30MHz -15 dB Min. @ 40 MHz -13 dB Min. @ 60 MHz -11 dB Min @ 80 MHz -10 dB Min. @ 100 MHz
4.9 Cross Talk:	-45 dB Min. @ 30 MHz -40 dB Min. @ 60 MHz -35 dB Min. @ 100 MHz
4.10 Common Mode Rejection :	-43 dB Min. @ 1-30 MHz -37dB Min. @ 60 MHz -33dB Min. @ 80-100 MHz
4.11 Isolation HI-POT:	1500Vrms 1mA 1Second

5. Recommended Lead Free IR Reflow Soldering Curve :

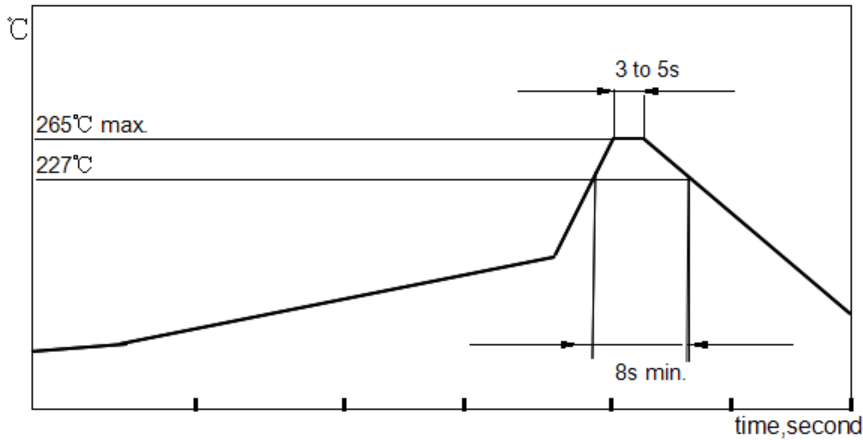

Item	Soldertechnique simulation	Temperature (°C)	Time(s)	Temperature ramp/immersion and emersion rate
1	Solder iron	350 ± 10 (solder irno temp)	4~5	
2	Vapor phase reflow	215 ± 5 (vapor temp)	60 ± 5	
3	IR/convection reflow	255 ± 5 (component temp)	30 ± 5	1°C/s~4°C/s time above 183°C 90s~120s

Note: The curve includes recommended value only, please adjust your equipment to make sure the solder process.Details please refers to the standard J-STD-020.

6. Reliability Test Criteria:

6.1 Terminal strength: Pull test withstand 9.8N 60+/-0.5S no looseness or movement.

6.2 Solderbility: Dipped in 245°C+/-5°C molten solder for 3+/-0.5 seconds,95% min shall be smooth any and bright.

6.3 Resistance to soldering heat : Convection reflow condition setting: peak temperature at 260°C+0/-5°C above 217°C for 90-180 seconds, ramp-up rate 2-3°C/s. Ramp-down rate 6°C/s Max. No mechanical problem found. No electrical failure found per our specification.

6.4 Vibration: 1.5mm amplitude total excursion 10-55-10 Hz traversed in 1minute, x.y.z, axis for 2 hours. Shall not be any abnormality.

6.5 Random drop (Packing condition): Height 60cm, 3 times on the wood floorboard ,shall not be any abnormality.

6.6 Dry heat: 100+/-2°C 96 hours.

6.7 Cold: -20+/-2°C 96 hours.

6.8 Damp Heat: 60+/-2°C, 93+/-3% RH 96 hours.

6.9 Change of temperature: exposed 5 cycle; each consisting of 30 minutes at -20+/-2°C,2-3minutes at 20+/-2°C,30 minutes at 85+/-2°C, 2-3 minutes at 20+/-2°C.