

FEATURES

- Wide operating voltage:36~75V
- High Efficiency 94% (12V/5A, 48V input)
- Industry standard,
 - ✓ 33.0mm x 22.9 mm x 10.5 mm
 - ✓ 1.30 in x 0.90 in x 0.41 in
- Encapsulation for “ TP ”:
 - ✓ 33.0 mm x 22.9 mm x 12.7mm
 - ✓ 1.30 in x 0.90 in x 0.50 in
- Tightly regulated single output:
 - ✓ 12V/5A
- Output power up to 60W
- Constant switching frequency
- Remote sense
- Output over-current / short-circuit protection
- Input under-voltage Protection
- ON/OFF control polarity selectable
 - ✓ Negative: R/C connect Vin- for normal operation
 - ✓ Positive: R/C floating or High Level for normal operation
- Monotonic start-up
- Wide Operating Temperature:
 - ✓ Open Frame version: -40°C~+85°C

APPLICATIONS

- Small-cell Base station
- Industrial Equipment
- Surveillance
- High-Power PoE device
- Wireless Networks
- Distribute Power Architecture

Description

The MQ93L06ST120 Series Power Modules are isolated single output dc-dc converter that operates over a wide input voltage range of 36V_{dc} to 75V_{dc} and provide a precisely (1%) regulated dc output in standard 1/16-brick size. The module features 94% high efficiency at 12V output with 5A load and 48V_{dc} input, so it is a superior power solution for small-cell base station powered by remote supply, e.g. PoE or photoelectric composite cable. The “-TP” version simplifies design of system heatsink.

Standard features include remote On/Off, remote sense, output voltage adjustment, over-current protection and input under-voltage protection.

***** **Typical Application Circuit** *****

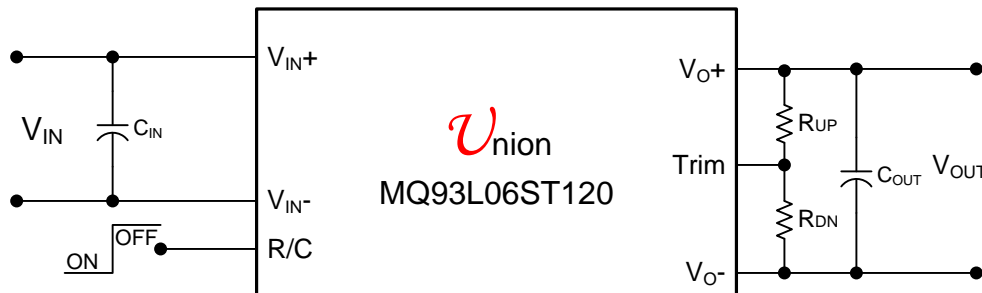

Performance Specifications(at T_A=+25°C)

Model	Input V _{IN} Range (V)	Output				Efficiency (%)
		P _{OUT} (W)	V _O (V)	Regulation		
				Line (%)	Load (%)	
MQ93L06ST120	36~75	60	12	1	1	94

Mechanical Outline Diagram

Unit: millimeters and [inches]

Tolerances: x.x ±0.5mm [x.xx in. ±0.02in.], x.xx ±0.25mm [x.xxx in. ±0.010 in.], unless otherwise noted

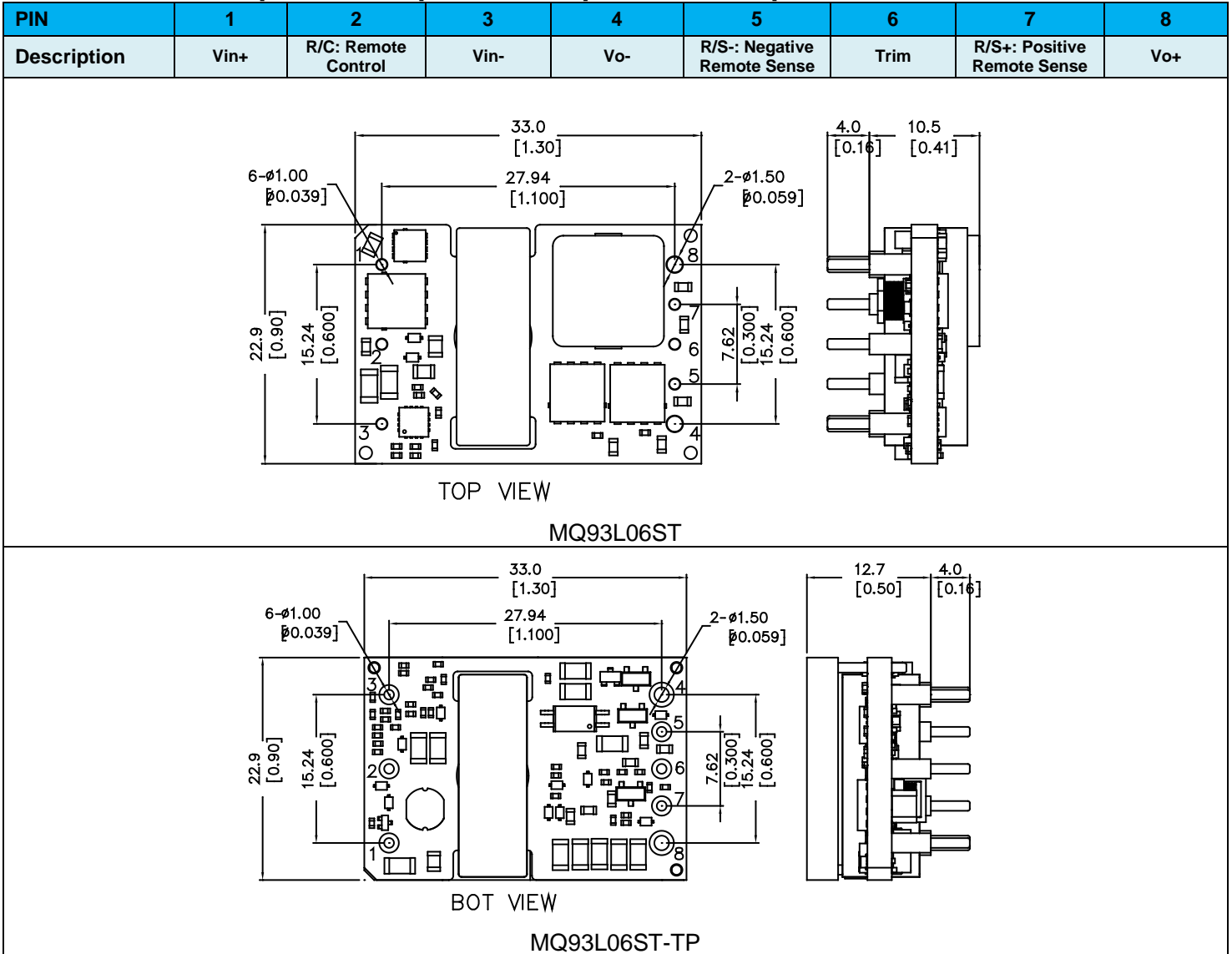

Ordering Information

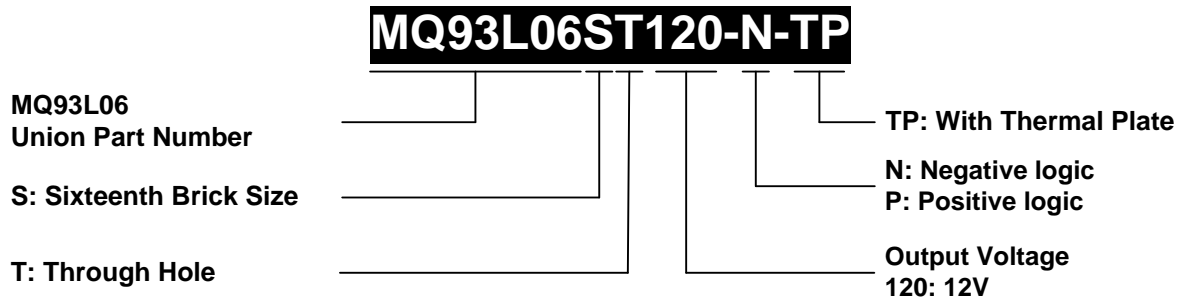

Absolute Maximum Ratings

Note: These are stress ratings. Exposure of devices to any of these conditions may adversely affect long-term reliability. Proper operation under conditions other than those listed in the Performance Specifications Table is not implied.

Parameter	Symbol	Min	Max	Unit
Input Voltage	V_{IN}	-0.3	80	V
Operating Ambient Temperature	T_A	-40	85	°C
Storage Temperature	T_{STG}	-55	125	°C
Altitude			4000	m
I/O Isolation voltage (100% factory Hi-pot tested)			2250	Vdc

MQ93L06ST120 General Specifications:

Note: Unless otherwise indicated, specifications apply over all operating input voltage, resistive load, and temperature conditions.

Parameter	Condition	Symbol	Min	Typ	Max	Unit
Operating range		$V_{IN,op}$	36	48	75	V
Maximum input current	$V_{in}=V_{in,min}$ to $V_{in,max}$, $V_o=V_{o,set}$, $I_o=I_{o,max}$	$I_{in,max}$		1.34		A
Input No Load Current	$V_{in}=48V$, $V_o=V_{o,set}$, $I_o=0$, module enabled	$I_{in,noload}$		34		mA
Input Standby Current	$V_{in}=48V$, module disabled			2		mA
Input Under-voltage Lockout	Turn on threshold Turn off threshold hysteresis	V_{UVLO}		34 32 2		Vdc
Turn on Delay	Tdelay = on/off pin transition until $V_o = 10\%$ of $V_{o,set}$			360		mS
Rise Time	Time for V_o to rise from 10% to 90% of $V_{o,set}$			10		mS
Switching Frequency		F_s		350		kHz
V_o	$V_{in}=V_{in,MIN}$ to $V_{in,MAX}$, $I_o=I_{o,MAX}$, $T_A=25^\circ C$			12		V
Regulation	100% load	ΔV_o	-1		+1	%
Output adjust range		$V_{o,ADJ}$	-10		+10	% $V_{o,set}$
Output current		I_o	0		5	A
Current limit		I_{OCP}		8		A
Output ripple & noise	$V_{in}=V_{in,MIN}$ to $V_{in,MAX}$, $I_o=I_{o,MAX}$, $T_A=25^\circ C$, $C_o=100\mu F$ OS-CON, $10\mu f+0.1\mu f$ MLCC, 5Hz~20MHz 带宽			100		mV _{pp}
Recommended capacitive load	LOW ESR OS-CON and MLCC		100	300	1200	μF
Transient Response	Load step from 50%~75%~50% $I_{o,max}$ $C_o=330\mu F$ OS-CON+ $10\mu f+0.1\mu f$ MLCC, $di/dt=0.1A/\mu S$			800		mV _{pp}
	Response time			10		mS
EFF	$V_{in}=36V$, $I_o=5A$, $T_A=25^\circ C$			93.5		%
	$V_{in}=48V$, $I_o=5A$, $T_A=25^\circ C$			94		%
	$V_{in}=75V$, $I_o=5A$, $T_A=25^\circ C$			92.5		%
EN	Logic "High" (typical Open Drain) Logic "High" maximum leakage current	V_{EN} I_{EN}	3 -	- 5	18 20	V μA
Isolation Capacitance				1000		pF
I/O Isolation Voltage	100% factory Hi-pot tested				2250	Vdc
Weight	Open Frame			16		g

CAUTION: This power module is not internally fused. An input line fuse must always be used.

This power module can be used in a wide variety of applications, ranging from simple standalone operation to an integrated part of sophisticated power architectures. To preserve maximum flexibility, internal fusing is not included, however, to achieve maximum safety and system protection, always use an input line fuse. The safety agencies require a fast-acting fuse with a maximum rating of 15 A. Based on the information provided in this data sheet on inrush energy and maximum dc input current, the same type of fuse with a lower rating can be used. Refer to the fuse manufacturer's data sheet for further information.

Test Configurations

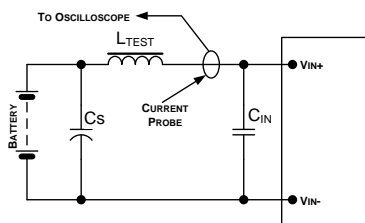

Note: Measure input reflected ripple current with a simulated source inductance (L_{TEST}) of $12\mu\text{H}$. Capacitor C_S offsets possible battery impedance. Measure current as shown above.

Fig 1. Input Reflected Ripple Current Test Setup

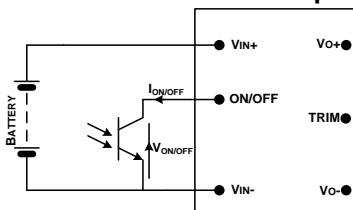

Note: an open collector switch is recommended for remote on/off control, controlling this switch to turn on or off the unit.

Fig 4. Remote On/Off

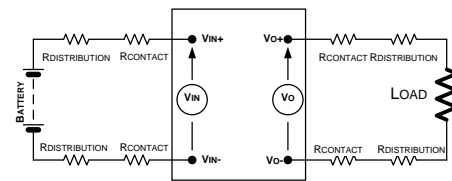

Note: All voltage measurements to be taken at the module terminals, as shown above. If sockets are used then Kelvin connections are required at the module terminals to avoid measurement errors due to socket contact resistance.

Fig 2. Output Voltage and Efficiency Test Setup

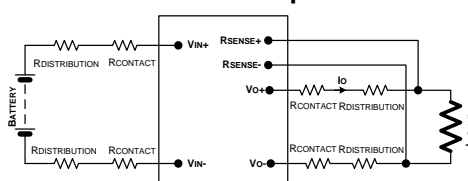

Note: Remote sense function is used to minimize the effects of distribution losses by regulating the voltage at the remote-sense connections.

Fig 5. Remote Sense

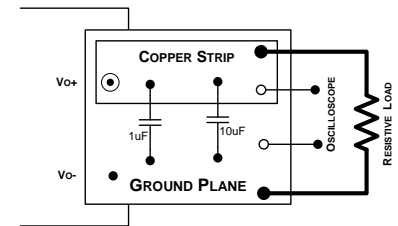

Note: All voltage measurements to be taken at the module terminals, as shown above. If sockets are used then Kelvin connections are required at the module terminals to avoid measurement errors due to socket contact resistance.

Fig 3. Output Ripple and Noise Test Setup

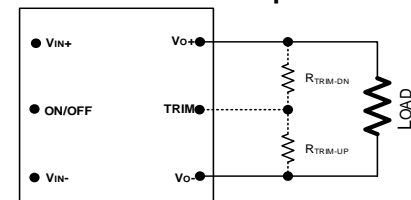

Note: Trimming function is allowed the output voltage set point to be adjusted from the default value in a allowed range.

Fig 6. Output Trim

Input Filtering

The power module should be connected to a low ac-impedance source. Highly inductive source impedance can affect the stability of the power module. For the test configuration in **Fig 1. Input Reflected Ripple Current Test Setup**, a $100\mu\text{F}$ electrolytic capacitor ($\text{ESR} < 0.7R$ at 100kHz), mounted close to the power module helps ensure the stability of the unit. Consult the factory for further application guidelines.

Safety Considerations

For safety-agency approval of the system in which the power module is used, the power module must be installed in compliance with the spacing and separation requirements of the end-use safety agency standard, i.e. UL60950-1, CSA C22.2 No.60950-1, and VDE0805-1(IEC60950-1). If the input source is non-SELV (ELV or a hazardous voltage greater than 60Vdc and less than or equal to 75Vdc), for the module's output to be considered as meeting the requirements for safety extra-low voltage (SELV), all of the following must be true:

- ✓ The input source is to be provided with reinforced insulation from any other hazardous voltages, including the ac mains.
- ✓ One VIN pin and one VOUT pin are to be grounded, or both the input and output pins are to be kept floating.
- ✓ The input pins of the module are not operator accessible.

Another SELV reliability test is conducted on the whole system (combination of supply source and subject module), as required by the safety agencies, to verify that under a single fault, hazardous voltages do not appear at the module's output.

Note: Do not ground either of the input pins of the module without grounding one of the output pins. This may allow a non-SELV voltage to appear between the output pins and ground.

The power module has extra-low voltage (ELV) outputs when all inputs are ELV.

All flammable materials used in the manufacturing of these modules are rated 94V-0, or tested to the UL60950 A.2 for reduced thickness.

For input voltages exceeding -60Vdc but less than or equal to -75Vdc , these converters have been evaluated to the applicable requirements of **BASIC INSULATION** between secondary **DC MAINS DISTRIBUTION** input (classified as TNV-2 in Europe) and unearthed SELV outputs.

The input to these units is to be provided with a maximum 3A fast-acting fuse in the ungrounded lead.

Feature Descriptions Remote On/Off

Two remote on/off options are available. Positive logic (device code suffix "P") turns the module on during a logic high voltage on the ON/OFF pin, and off during a logic low. Negative logic remote On/Off, device code suffix "N", turns the module off during a logic high and on during a logic low.

To turn the power module on and off, the user must supply a switch (open collector or equivalent) to control the voltage ($V_{on/off}$) between the ON/OFF terminal and the VIN(-) terminal, see **Fig 4. Remote On/Off**. Logic low is $0V \leq V_{on/off} \leq 0.6V$. The maximum $I_{on/off}$ during a logic low is 0.15mA; the switch should maintain a logic low level whilst sinking this current. During a logic high, the typical maximum $V_{on/off}$ generated by the module is 5V, and the maximum allowable leakage current at $V_{on/off} = 5V$ is 1 μ A.

If not using the remote on/off feature:

For positive logic, leave the ON/OFF pin open.

For negative logic, short the ON/OFF pin to VIN(-).

Remote Sense

Remote sense minimizes the effects of distribution losses by regulating the voltage at the remote-sense connections, see **Fig 5. Remote Sense** for the detail configuration. The voltage between the remote-sense pins and the output terminals must not exceed the output voltage sense range given in the Feature Specifications table:

$$[V_{O(+)} - V_{O(-)}] - [SENSE(+) - SENSE(-)] \leq 0.5 V$$

Although the output voltage can be increased by both the remote sense and by the trim, the maximum increase for the output voltage is not the sum of both. The maximum increase is the larger of either the remote sense or the trim.

The amount of power delivered by the module is defined as the voltage at the output terminals multiplied by the output current. When using remote sense and trim, the output voltage of the module can be increased, which at the same output current would increase the power output of the module. **Care should be taken to ensure that the maximum output power of the module remains at or below the maximum rated power (Maximum rated power = $V_{o,set} \times I_{o,max}$).**

Output Trim

MQ93L06ST120 output can be trimmed up or down by connecting one resistor to output negative or positive end as **Fig 6**.

Connecting an external resistor (R_{DN}) between the TRIM pin and the $V_{O(+)}$ (or Sense(+)) pin decreases the output voltage set point. To maintain set point accuracy, the trim resistor tolerance should be $\pm 1.0\%$. The following equation determines the required external resistor value:

$$R_{DN} = \left[\frac{(V_{O,DN} - 2.5) * 12}{V_{O,SETP} - V_{O,DN}} - 2 \right] K\Omega$$

$V_{O,SET}$ is the output default set-point voltage of the module, $V_{O,DN}$ is the desired trim-down output voltage.

Connecting an external resistor (R_{UP}) between the TRIM pin and the $V_{O(-)}$ (or Sense (-)) pin increases the output voltage set point. The following equation determines the required external resistor value:

$$R_{UP} = \left(\frac{30}{V_{O,UP} - V_{O,SET}} - 2 \right) K\Omega$$

$V_{O,SET}$ is the output default set-point voltage of the module, $V_{O,UP}$ is the desired trim-up output voltage

Input Under-Voltage Lockout

At input voltages below the input under-voltage lockout limit, the module operation is disabled. The module will only begin to operate once the input voltage is raised above the under-voltage lockout turn-on threshold, $V_{UV,ON}$. Once operating, the module will continue to operate until the input voltage is taken below the under-voltage turn-off threshold, $V_{UV,OFF}$.

Over-temperature Protection

To provide protection under certain fault conditions, the unit is equipped with a thermal shutdown circuit. The unit will shut down if the thermal reference points, T_{ref} , exceed critical temperature, but the thermal shutdown is not intended as a guarantee that the unit will survive temperatures beyond its rating. The module will automatically restart upon cool-down to a safe temperature.

Output Overvoltage Protection

The output overvoltage protection scheme of the modules has an independent over voltage loop to prevent single point of failure. This protection feature latches in the event of over voltage across the output. Cycling the on/off pin or input

voltage resets the latching protection feature. If the auto-restart option is ordered, the module will automatically restart upon an internally programmed time elapsing.

Overcurrent Protection

To provide protection in a fault (output overload) condition, the unit is equipped with internal current-limiting circuitry and can endure current limiting continuously. At the point of current-limit inception, the unit enters hiccup mode. If the unit is not configured with auto-restart, then it will latch off following the over current condition. The module can be restarted by cycling the dc input power for at least one second or by toggling the remote on/off signal for at least one second.

If the unit is configured with the auto-restart option, it will remain in the hiccup mode as long as the Overcurrent condition exists; it operates normally, once the output current is brought back into its specified range. The average output current during hiccup is 10% $I_{o, max}$.

Thermal Considerations

The power modules operate in a variety of thermal environments; however, sufficient cooling should be provided to help ensure reliable operation. Considerations include ambient temperature, airflow, module power dissipation, and the need for increased reliability. A reduction in the operating temperature of the module will result in an increase in reliability. The thermal data presented here is based on physical measurements taken in a wind tunnel, using automated thermocouple instrumentation to monitor key component temperatures: FETs, diodes, control ICs, magnetic cores, ceramic capacitors, opto-isolators, and module pwb conductors, while controlling the ambient airflow rate and temperature. For a given airflow and ambient temperature, the module output power is increased, until one (or more) of the components reaches its maximum derated operating temperature, as defined in IPC-9592. This procedure is then repeated for a different airflow or ambient temperature until a family of module output derating curves is obtained.

Thermal Test Point

To enhance system reliability, the power module should always be operated below the maximum operating temperature. If the temperature exceeds the maximum module temperature, reliability of the unit may be affected. Sufficient airflow can improve the reliability of the Converter, so we recommend considering it in the design.

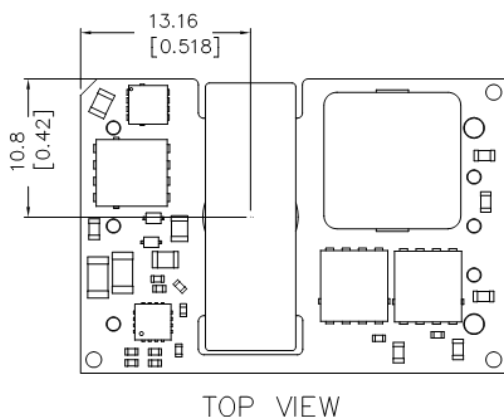

Fig7 Thermal test point(Open Frame Version)

Note: The temperature at the thermal test point on the converter cannot exceed 120°C (248°F).

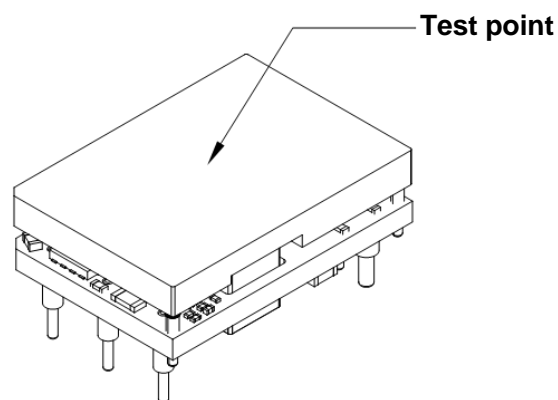
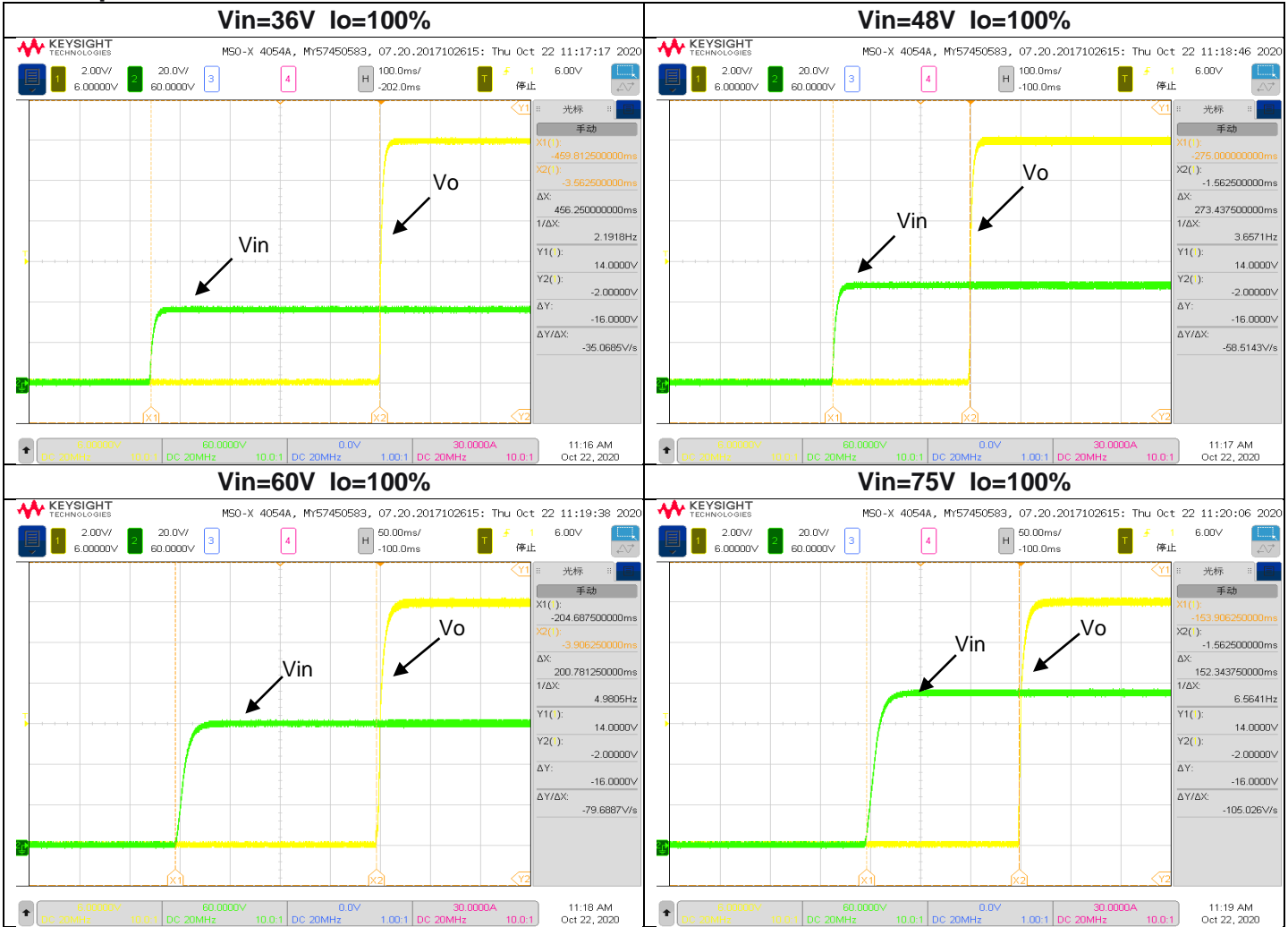

Fig8 Thermal test point(“-TP” Version)

Note: The temperature at the thermal test point on the converter cannot exceed 105°C (221°F).

Typical Characteristics- MQ93L06ST120

General conditions:
 Input filter: 100μF/100V*2
 Output filter: 476/16V *2
Start-up



Shut Down

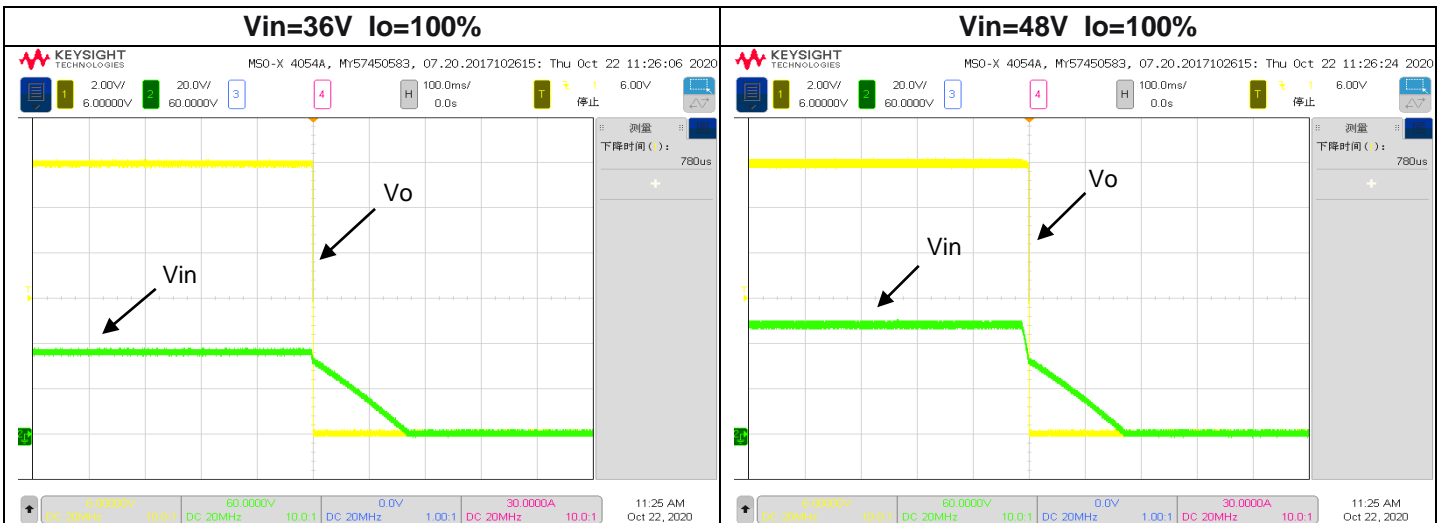

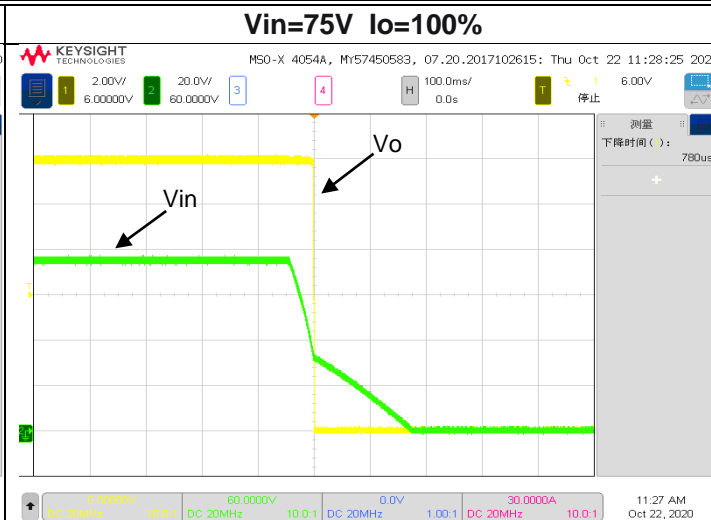
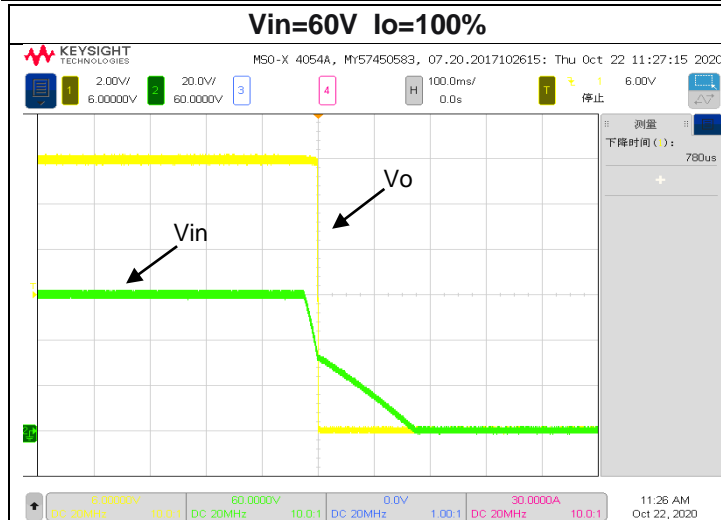

Output Ripple & Noise

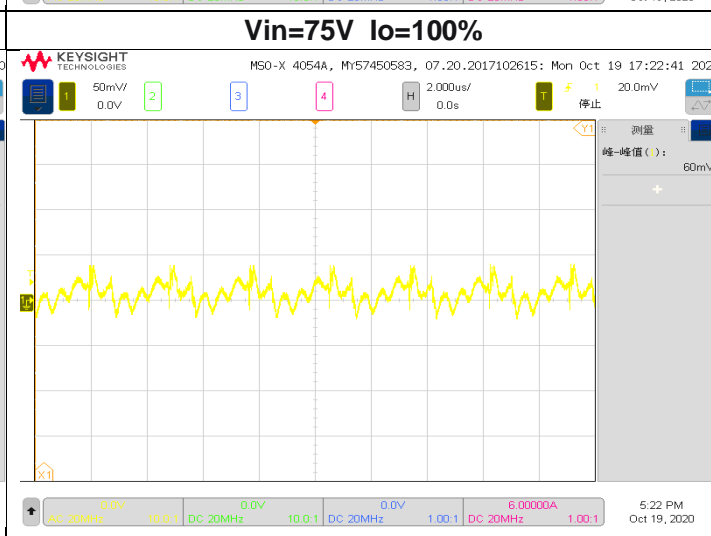
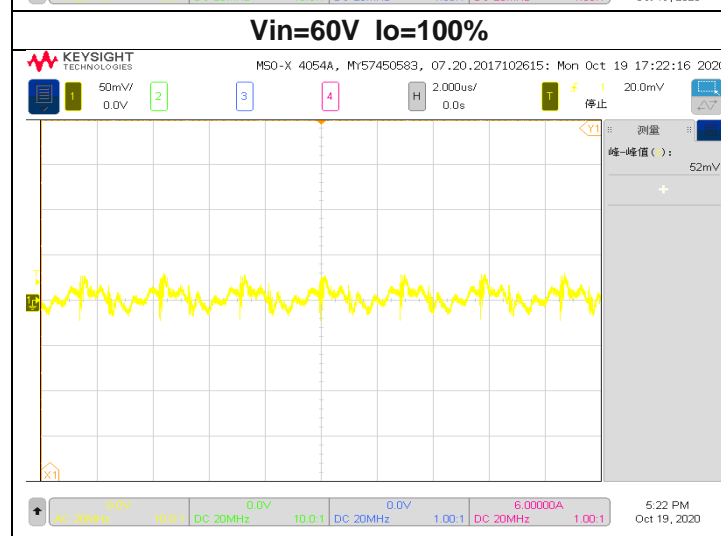
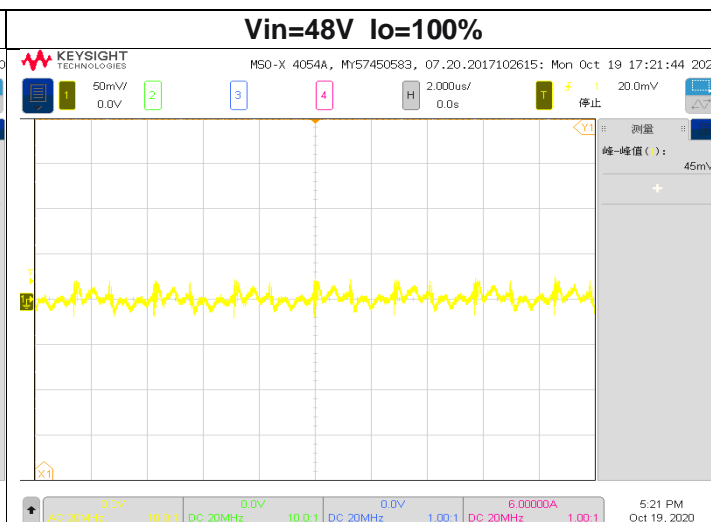
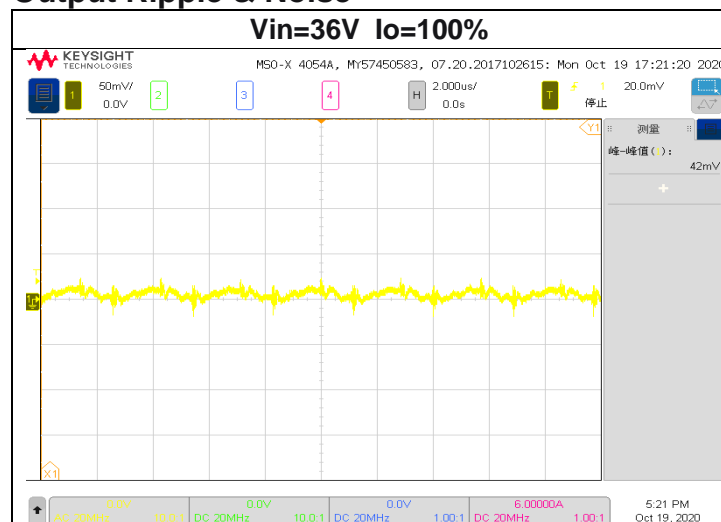

Output Load Transient Response

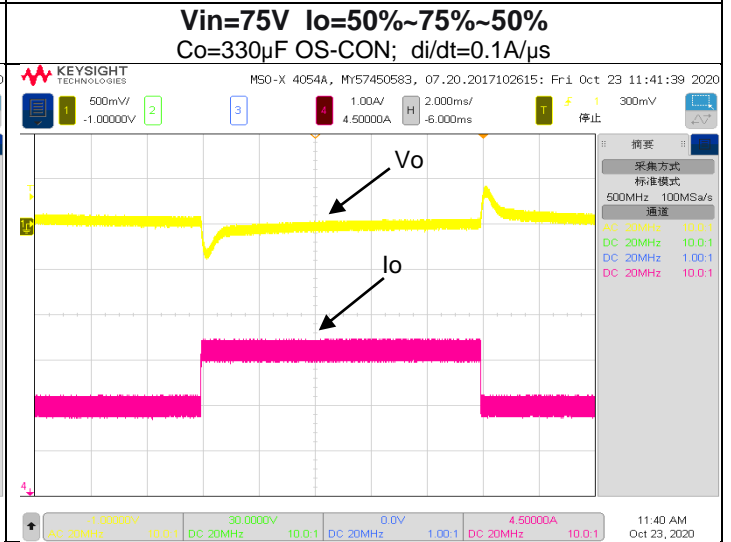
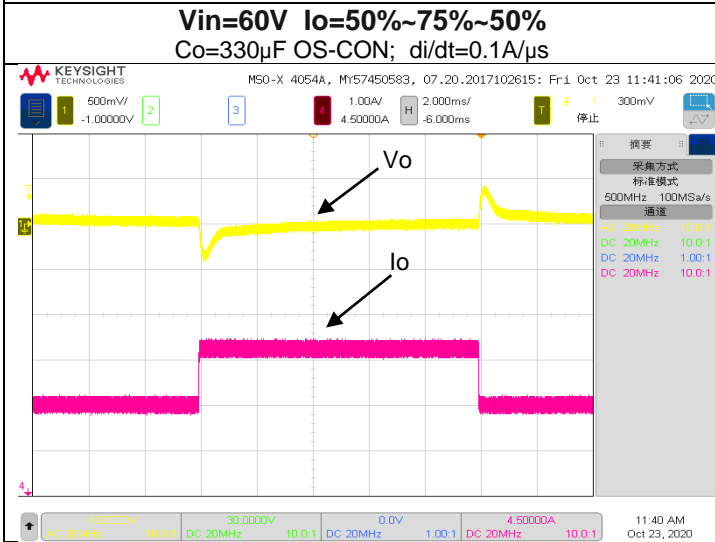
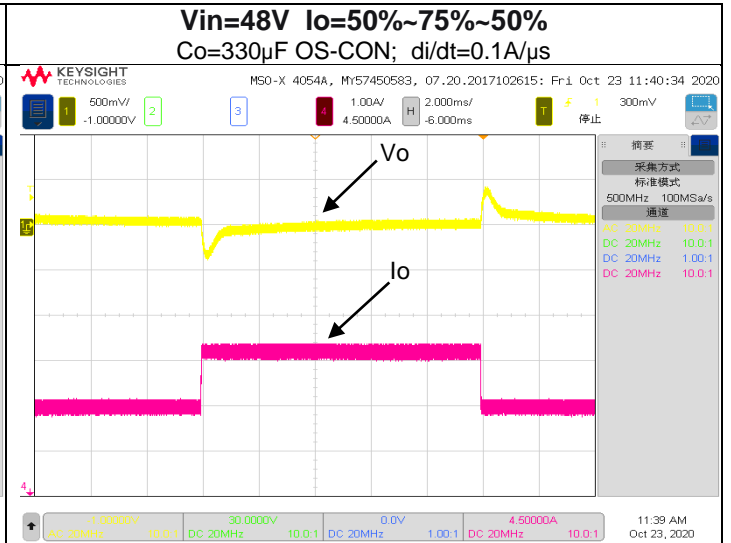
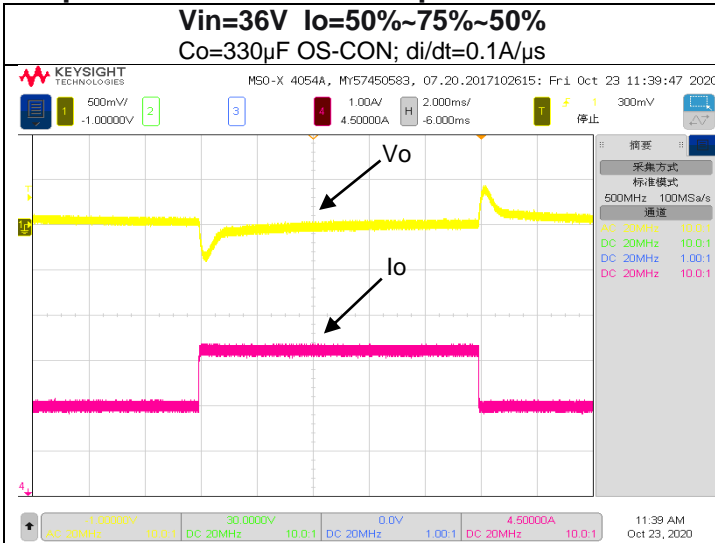

Over current protect

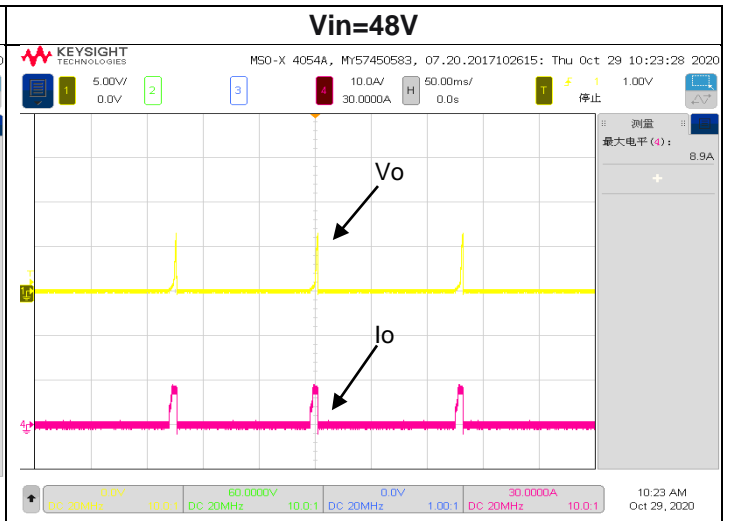
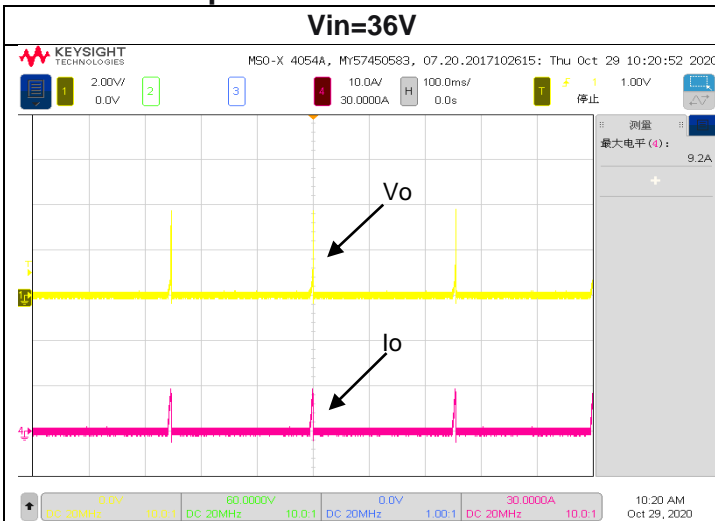

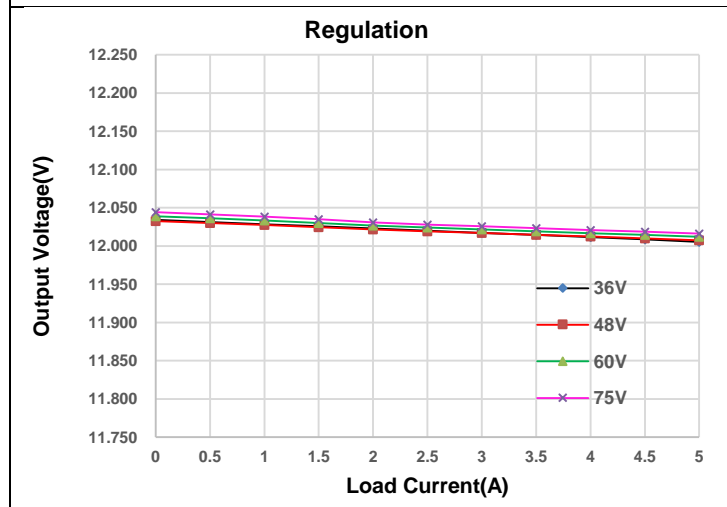
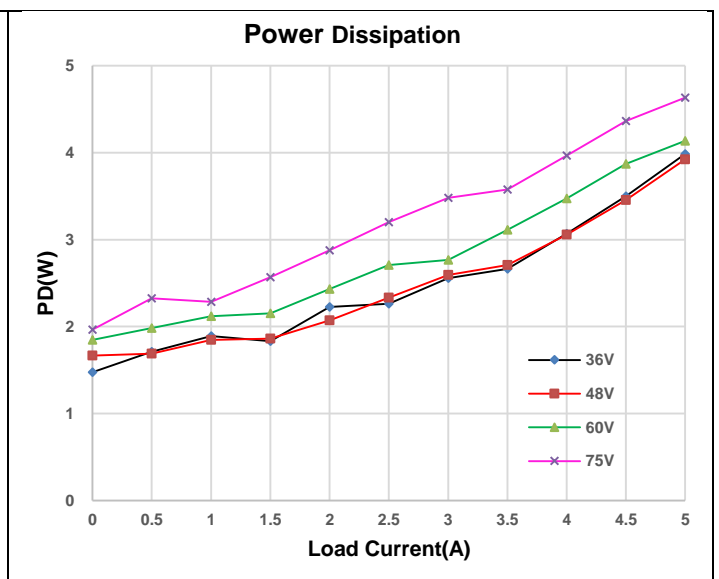
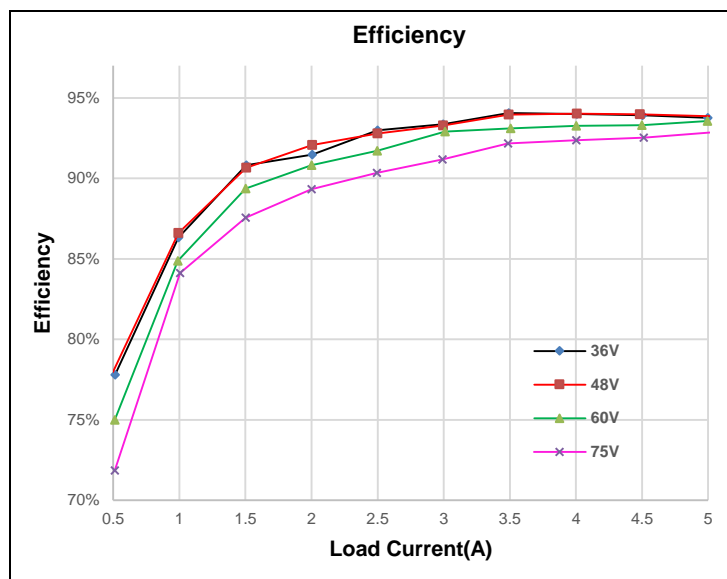
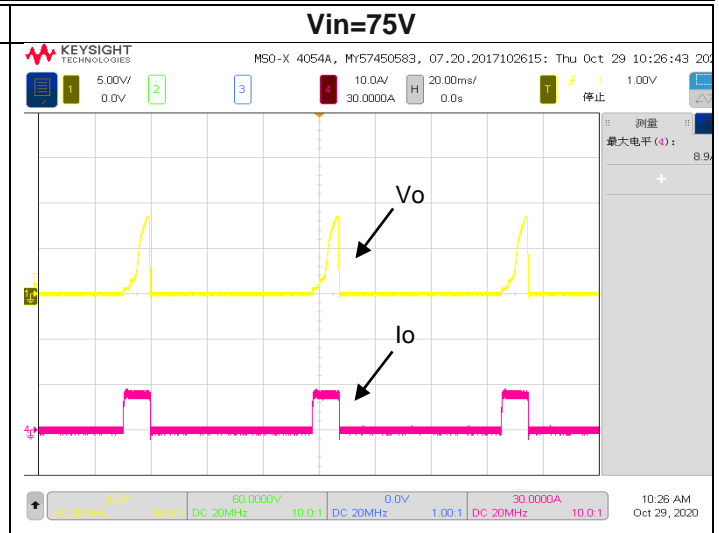
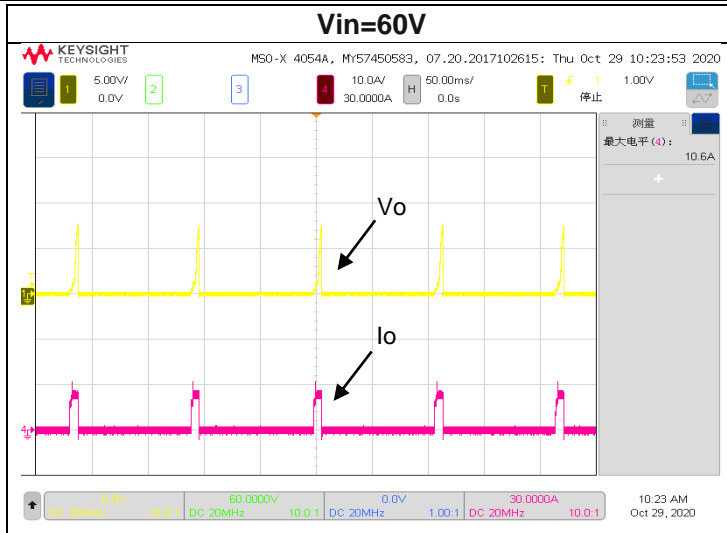

Power Derating

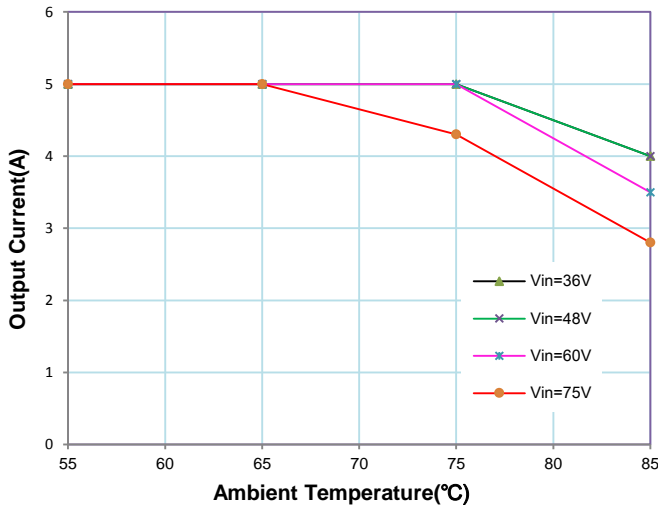

Note: Open Frame Version; Test in a closed box with a size of 200mm*160mm*140mm.

Power Derating

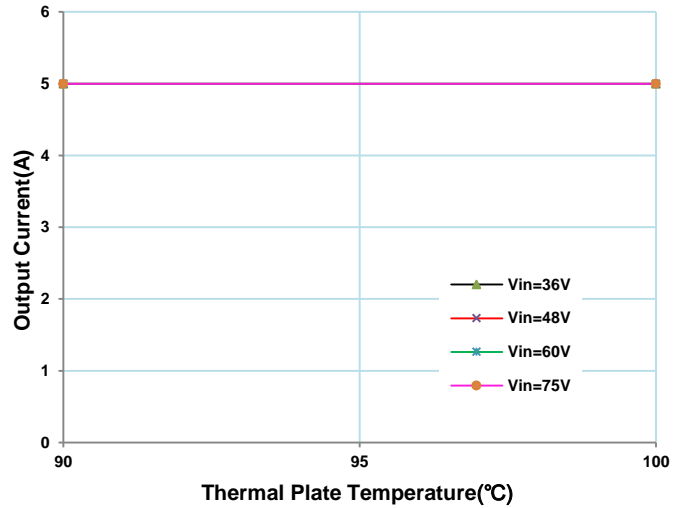

Note: "TP" Version; An aluminum plate with a size of 270mm*165mm*14mm was used in the test.

Power Derating (VIN=48V)

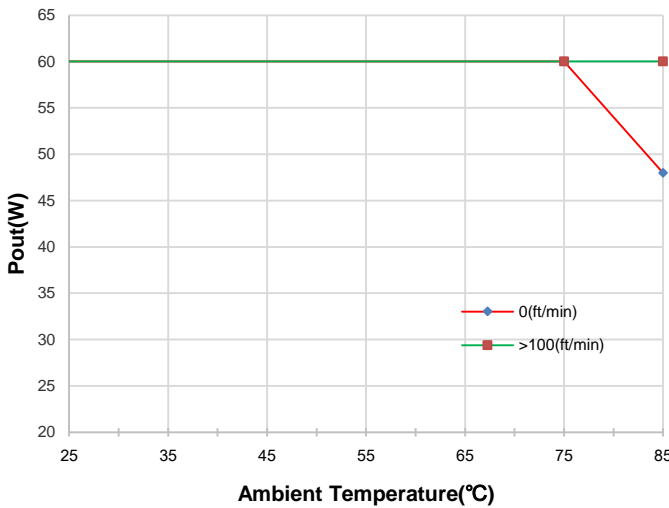

Note: Open Frame Version; 100ft/min=0.508m/s.

Power Derating (VIN=48V)

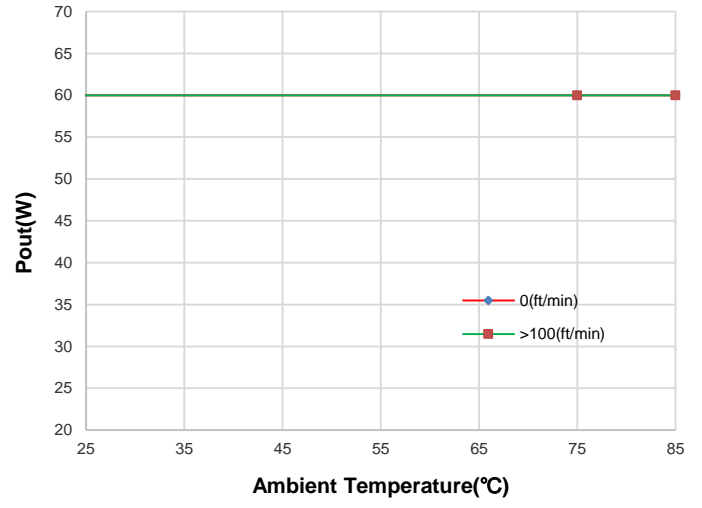

Note: "TP" Version; 100ft/min=0.508m/s.

Recommended Hole Pattern

Unit: millimeters (inches)

Tolerances: $x.x \pm 1.0$ mm (0.02in), $x.xx \pm 0.25$ mm (0.010in), unless otherwise noted

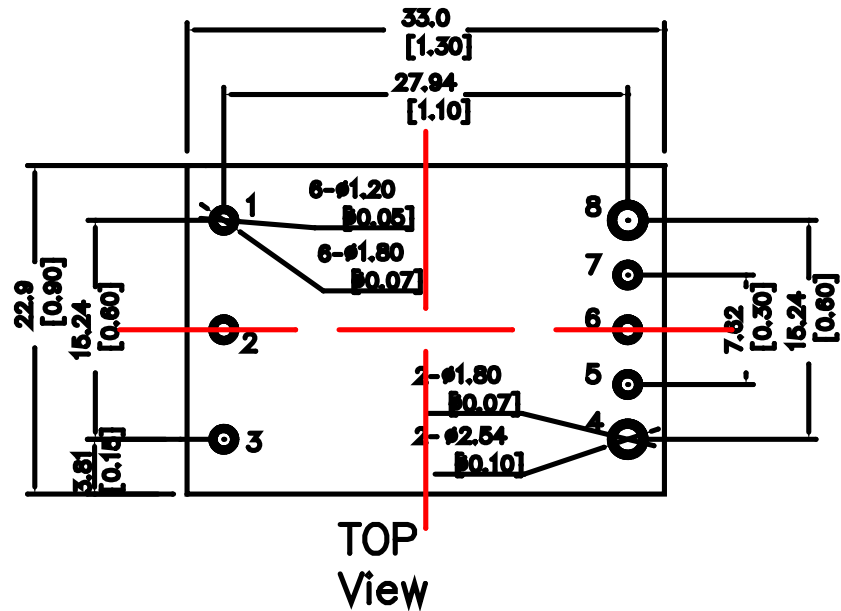

Component side footprint

Application Notes