

P-Channel 30-V (D-S) MOSFET

PRODUCT SUMMARY		
V_{DS} (V)	$r_{DS(on)}$ (Ω)	I_D (A)
-30	0.130 at $V_{GS} = -10$ V	-2.6
	0.200 at $V_{GS} = -4.5$ V	-2.0

General FEATURE

- TrenchFET Power MOSFET
- Lead free product is acquired
- Surface mount package

APPLICATION

- Load Switch for Portable Devices
- DC/DC Converter

SOT-23

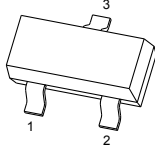

1.GATE
2.SOURCE
3.DRAIN

MARKING

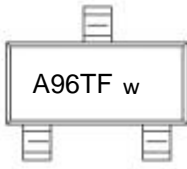

Equivalent Circuit

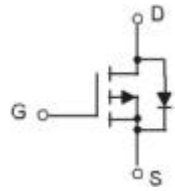

*w: week code

Absolute Maximum Ratings $T_A=25^\circ\text{C}$ unless otherwise noted				
Parameter	Symbol	Maximum	Units	
Drain-Source Voltage	V_{DS}	-30	V	
Gate-Source Voltage	V_{GS}	± 20	V	
Continuous Drain Current ^A	$T_A=25^\circ\text{C}$	I_D	A	
Pulsed Drain Current ^B				I_{DM}
Power Dissipation ^A	$T_A=25^\circ\text{C}$	P_D	1.25	W
Junction and Storage Temperature Range	T_J, T_{STG}	-55 to 150	$^\circ\text{C}$	

Thermal Characteristics					
Parameter	Symbol	Typ	Max	Units	
Maximum Junction-to-Ambient ^A	$R_{\theta JA}$	70	90	$t \leq 10\text{s}$	$^\circ\text{C/W}$
Maximum Junction-to-Ambient ^A				Steady-State	100
Maximum Junction-to-Lead ^C	$R_{\theta JL}$	63	80	Steady-State	$^\circ\text{C/W}$

Electrical Characteristics (T_J=25°C unless otherwise noted)

Symbol	Parameter	Conditions	Min	Typ	Max	Units
STATIC PARAMETERS						
BV _{DSS}	Drain-Source Breakdown Voltage	I _D =-250μA, V _{GS} =0V	-30			V
I _{DSS}	Zero Gate Voltage Drain Current	V _{DS} =-24V, V _{GS} =0V			-1	μA
I _{GSS}	Gate-Body leakage current	V _{DS} =0V, V _{GS} =±20V			±100	nA
V _{GS(th)}	Gate Threshold Voltage	V _{DS} =V _{GS} I _D =-250μA	-0.8	-1.4	-2.0	V
I _{D(ON)}	On state drain current	V _{GS} =-4.5V, V _{DS} =-5V	-5			A
R _{DS(ON)}	Static Drain-Source On-Resistance	V _{GS} =-10V, I _D =-2.6A		97	130	mΩ
		V _{GS} =-4.5V, I _D =-2A		166	200	mΩ
g _{FS}	Forward Transconductance	V _{DS} =-5V, I _D =-2.5A	3	3.8		S
V _{SD}	Diode Forward Voltage	I _S =-1A, V _{GS} =0V		-0.82	-1	V
I _S	Maximum Body-Diode Continuous Current				-2	A
DYNAMIC PARAMETERS						
C _{iss}	Input Capacitance	V _{GS} =0V, V _{DS} =-15V, f=1MHz		302	370	pF
C _{oss}	Output Capacitance			50.3		pF
C _{rss}	Reverse Transfer Capacitance			37.8	53	pF
R _g	Gate resistance	V _{GS} =0V, V _{DS} =0V, f=1MHz	6	12	18	Ω
SWITCHING PARAMETERS						
Q _{g(10)}	Total Gate Charge(10V)	V _{GS} =-10V, V _{DS} =-15V, I _D =-2.6A		6.8	9	nC
Q _{g(4.5)}	Total Gate Charge(4.5V)			2.4	3.1	nC
Q _{gs}	Gate Source Charge			1.6		nC
Q _{gd}	Gate Drain Charge			0.95		nC
t _{D(on)}	Turn-On DelayTime	V _{GS} =-10V, V _{DS} =-15V, R _L =5.8Ω, R _{GEN} =3Ω		7.5		ns
t _r	Turn-On Rise Time			3.2		ns
t _{D(off)}	Turn-Off DelayTime			17		ns
t _f	Turn-Off Fall Time			6.8		ns

TYPICAL ELECTRICAL AND THERMAL CHARACTERISTICS

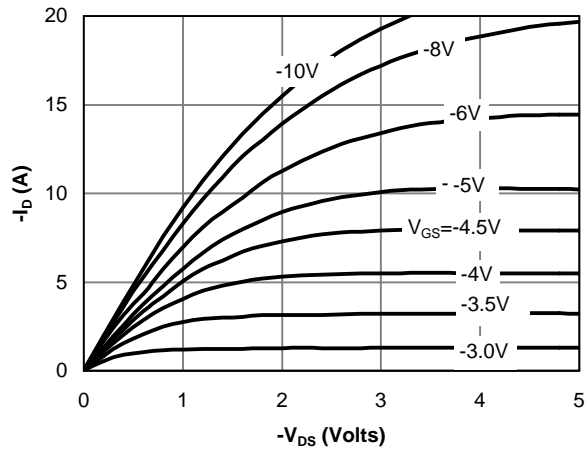

Fig 1: On-Region Characteristics

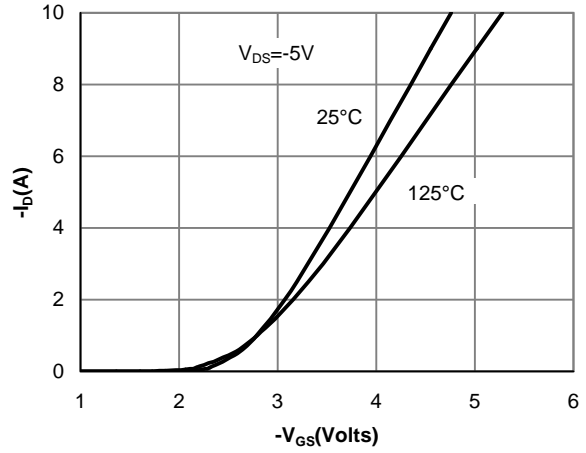

Figure 2: Transfer Characteristics

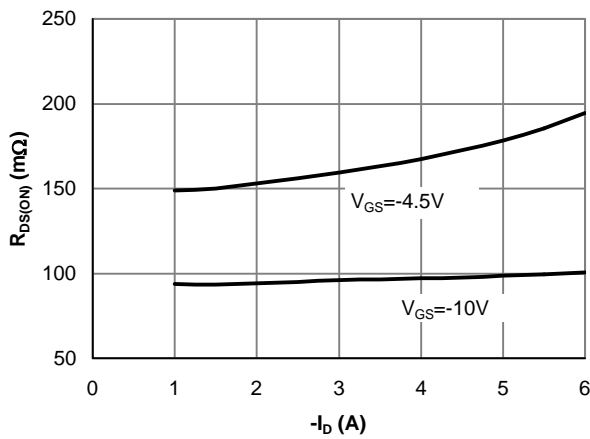

Figure 3: On-Resistance vs. Drain Current and Gate Voltage

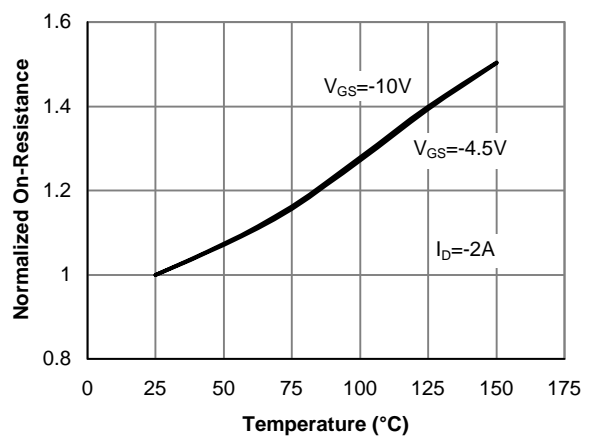

Figure 4: On-Resistance vs. Junction Temperature

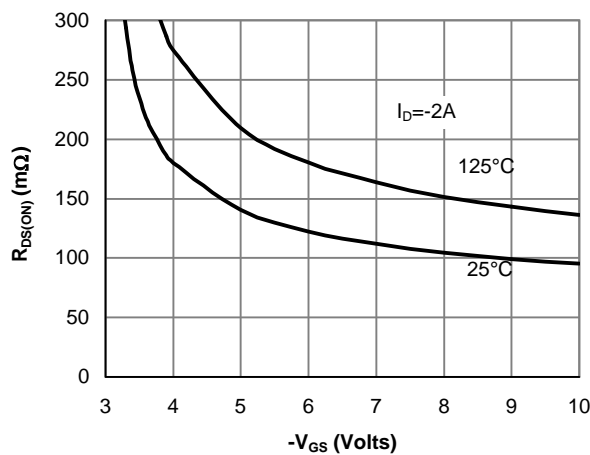

Figure 5: On-Resistance vs. Gate-Source Voltage

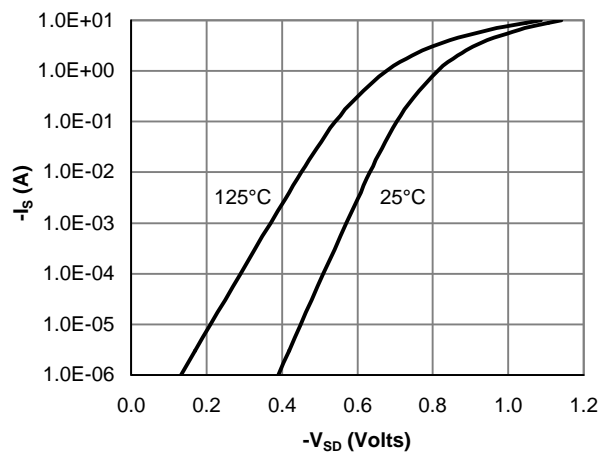

Figure 6: Body-Diode Characteristics

TYPICAL ELECTRICAL AND THERMAL CHARACTERISTICS

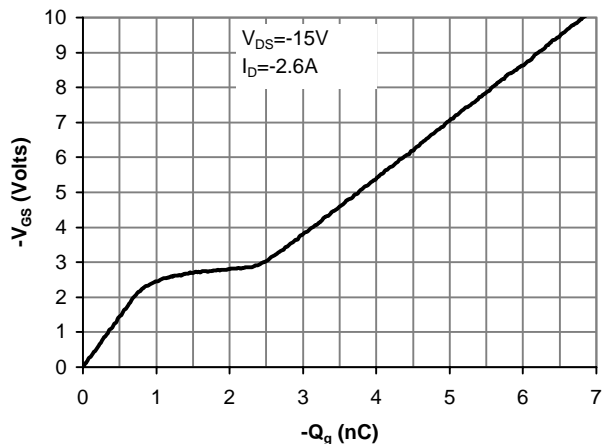

Figure 7: Gate-Charge Characteristics

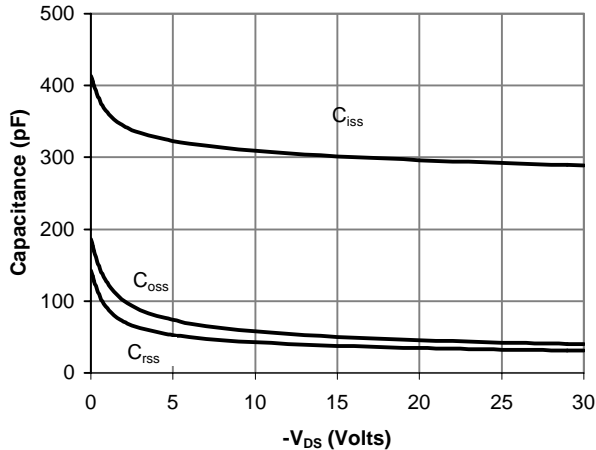

Figure 8: Capacitance Characteristics

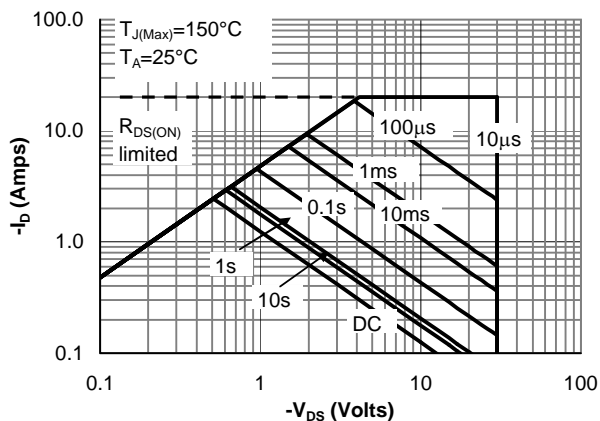

Figure 9: Maximum Forward Biased Safe Operating Area (Note E)

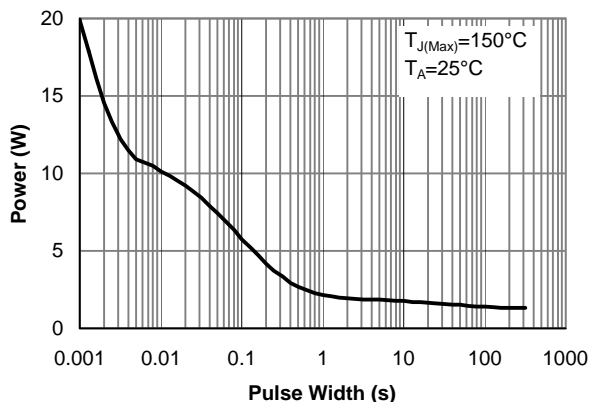

Figure 10: Single Pulse Power Rating Junction-to-Ambient (Note E)

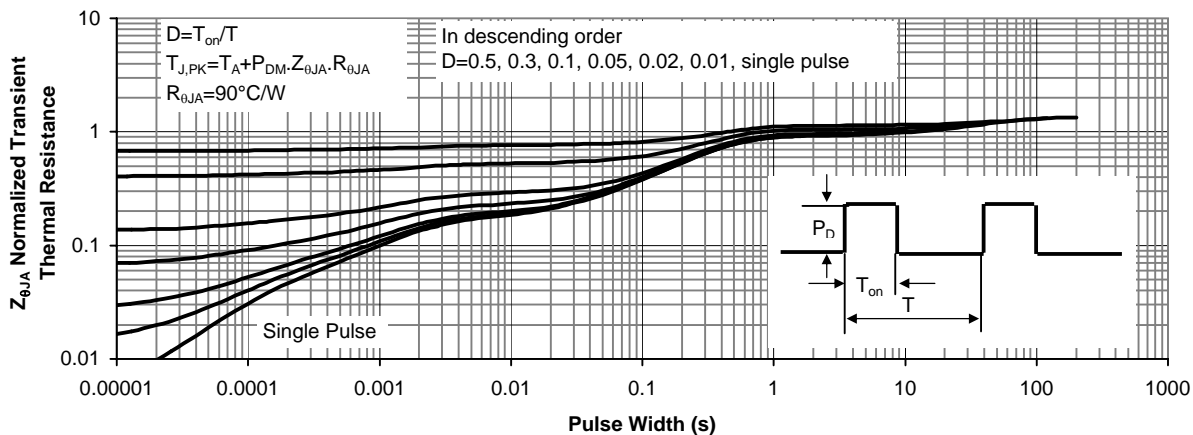
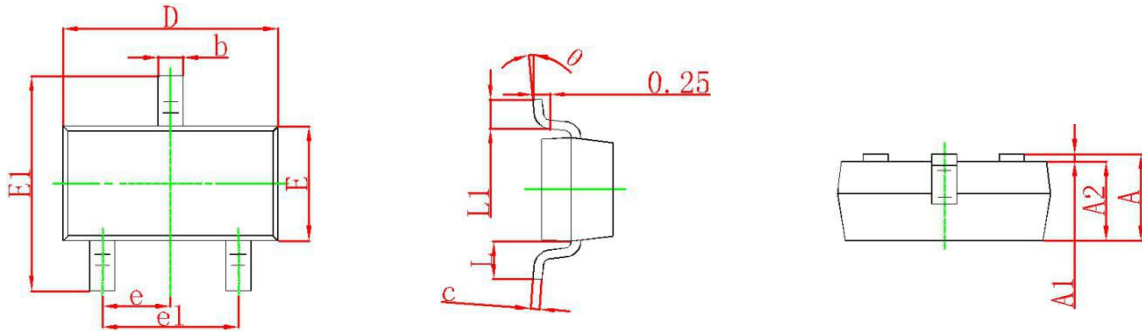

Figure 11: Normalized Maximum Transient Thermal Impedance

SOT-23 Package Outline Dimensions



Symbol	Dimensions In Millimeters		Dimensions In Inches	
	Min	Max	Min	Max
A	0.900	1.150	0.035	0.045
A1	0.000	0.100	0.000	0.004
A2	0.900	1.050	0.035	0.041
b	0.300	0.500	0.012	0.020
c	0.080	0.150	0.003	0.006
D	2.800	3.000	0.110	0.118
E	1.200	1.400	0.047	0.055
E1	2.250	2.550	0.089	0.100
e	0.950 TYP		0.037 TYP	
e1	1.800	2.000	0.071	0.079
L	0.550 REF		0.022 REF	
L1	0.300	0.500	0.012	0.020
θ	0°	8°	0°	8°

SOT-23 Suggested Pad Layout

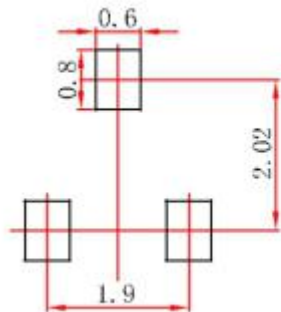

Note:

1. Controlling dimension: in millimeters.
2. General tolerance: $\pm 0.05\text{mm}$.
3. The pad layout is for reference purposes only.