

N and P-Channel Enhancement Mode Power MOSFET

Description

The 4606 uses advanced trench technology to provide excellent $R_{DS(ON)}$ and low gate charge. The complementary MOSFETs may be used to form a level shifted high side switch, and for a host of other applications.

General Features

● N-Channel

$$V_{DS} = 30V, I_D = 6.9A$$

$$R_{DS(ON)} < 21m\Omega @ V_{GS}=10V$$

$$R_{DS(ON)} < 32m\Omega @ V_{GS}=4.5V$$

● P-Channel

$$V_{DS} = -30V, I_D = -6.0A$$

$$R_{DS(ON)} < 45m\Omega @ V_{GS}=-10V$$

$$R_{DS(ON)} < 60m\Omega @ V_{GS}=-4.5V$$

- High power and current handing capability
- Lead free product is acquired
- Surface mount package

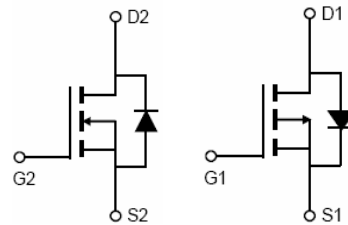

N-channel

P-channel

Schematic diagram

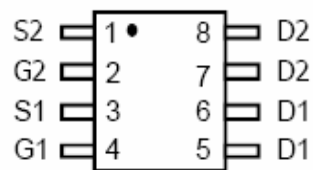

Marking and pin assignment



SOP-8 top view

Absolute Maximum Ratings ($T_A=25^\circ\text{C}$ unless otherwise noted)

Parameter		Symbol	N-Channel	P-Channel	Unit
Drain-Source Voltage		V_{DS}	30	-30	V
Gate-Source Voltage		V_{GS}	± 20	± 20	V
Continuous Drain Current	$T_A=25^\circ\text{C}$	I_D	6.9	-6.0	A
Pulsed Drain Current ^(Note 1)		I_{DM}	28	-26	A
Maximum Power Dissipation	$T_A=25^\circ\text{C}$	P_D	2.0	2.0	W
Operating Junction and Storage Temperature Range		T_J, T_{STG}	-55 To 150	-55 To 150	$^\circ\text{C}$

Thermal Characteristic

Thermal Resistance, Junction-to-Ambient ^(Note2)	$R_{\theta JA}$	N-Ch	63.5	$^\circ\text{C/W}$
Thermal Resistance, Junction-to-Ambient ^(Note2)	$R_{\theta JA}$	P-Ch	63.5	$^\circ\text{C/W}$

N-CH Electrical Characteristics (T_A=25°C unless otherwise noted)

Parameter	Symbol	Condition	Min	Typ	Max	Unit
Off Characteristics						
Drain-Source Breakdown Voltage	BV _{DSS}	V _{GS} =0V, I _D =250μA	30	-	-	V
Zero Gate Voltage Drain Current	I _{DSS}	V _{DS} =24V, V _{GS} =0V	-	-	50	μA
Gate-Body Leakage Current	I _{GSS}	V _{GS} =±20V, V _{DS} =0V	-	-	±100	nA

On Characteristics (Note 3)

Gate Threshold Voltage	V _{GS(th)}	V _{DS} =V _{GS} , I _D =250μA	1.2	1.6	2.4	V
Drain-Source On-State Resistance	R _{DS(ON)}	V _{GS} =10V, I _D =6.9A	-	19	21	mΩ
		V _{GS} =4.5V, I _D =5A	-	29	32	mΩ
Forward Transconductance	g _{FS}	V _{DS} =5V, I _D =5.0A	5	-	-	S

Dynamic Characteristics (Note 4)

Input Capacitance	C _{ISS}	V _{DS} =15V, V _{GS} =0V, F=1.0MHz	-	398	-	PF
Output Capacitance	C _{OSS}		-	67	-	PF
Reverse Transfer Capacitance	C _{RSS}		-	61	-	PF

Switching Characteristics (Note 4)

Turn-on Delay Time	t _{d(on)}	V _{DD} =15V, R _L =15Ω V _{GS} =10V, R _{GEN} =6Ω I _D =1.0A	-	8.0	-	nS
Turn-on Rise Time	t _r		-	11.5	-	nS
Turn-Off Delay Time	t _{d(off)}		-	17	-	nS
Turn-Off Fall Time	t _f		-	7.5	-	nS
Total Gate Charge	Q _g	V _{DS} =10V, I _D =1.0A, V _{GS} =10V	-	7.5	-	nC
Gate-Source Charge	Q _{gs}		-	1.7	-	nC
Gate-Drain Charge	Q _{gd}		-	1.3	-	nC

Drain-Source Diode Characteristics

Diode Forward Voltage (Note 3)	V _{SD}	V _{GS} =0V, I _S =2A	-	0.75	1.0	V
--------------------------------	-----------------	---	---	------	-----	---

Notes:

1. Repetitive Rating: Pulse width limited by maximum junction temperature.
2. Surface Mounted on FR4 Board, t ≤ 10 sec.
3. Pulse Test: Pulse Width ≤ 300μs, Duty Cycle ≤ 2%.
4. Guaranteed by design, not subject to production

Characteristics Curve(N-Channel)

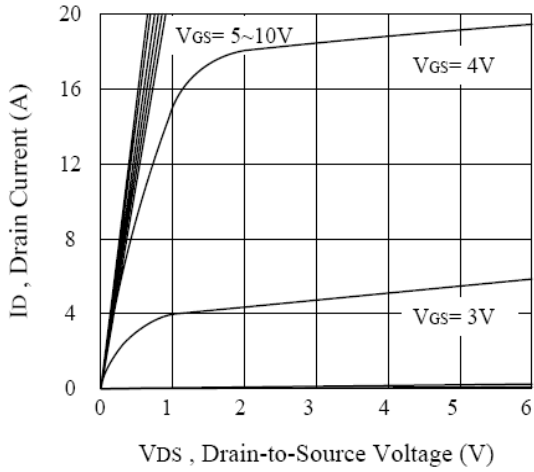

Figure 1. Output Characteristics

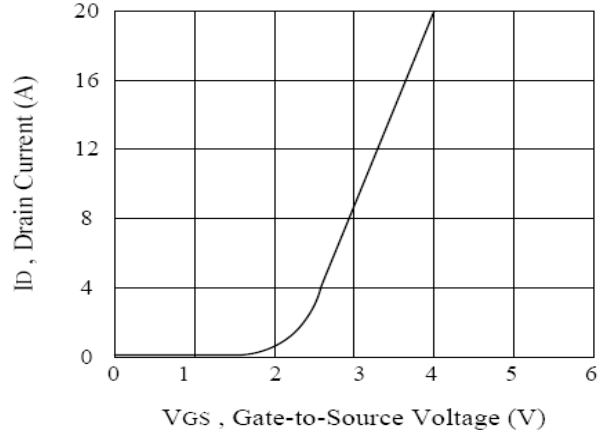

Figure 2. Transfer Characteristics

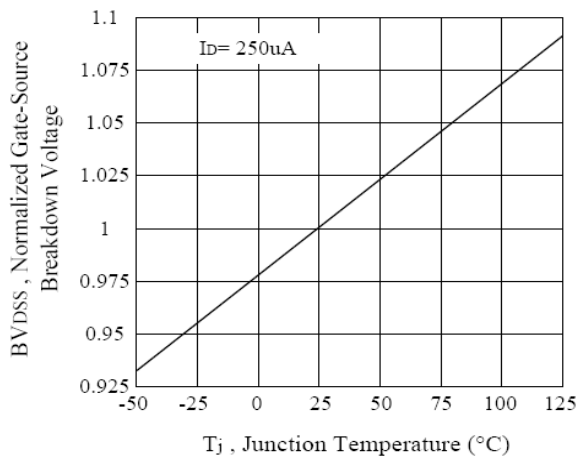

Figure 3. Breakdown Voltage Variation with Temperature

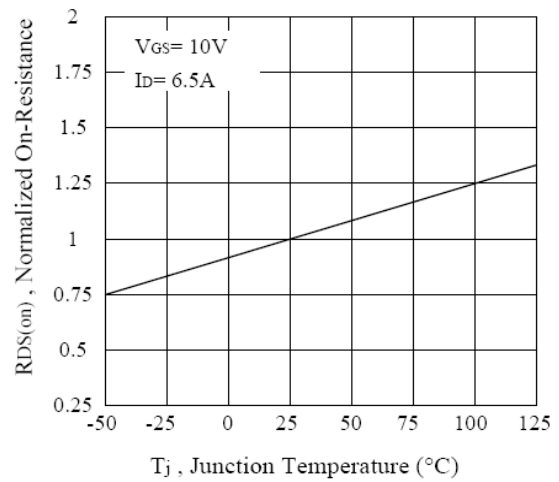

Figure 4. On-Resistance Variation with Temperature

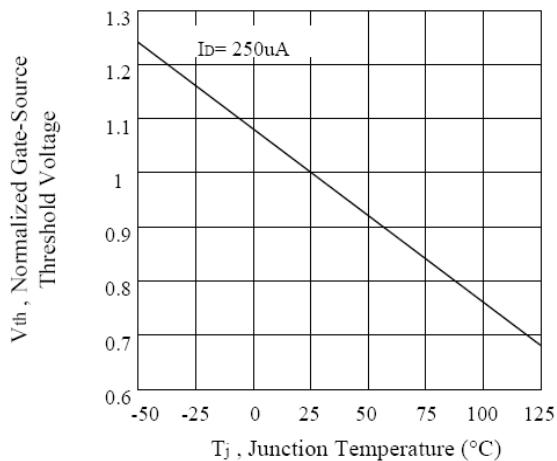
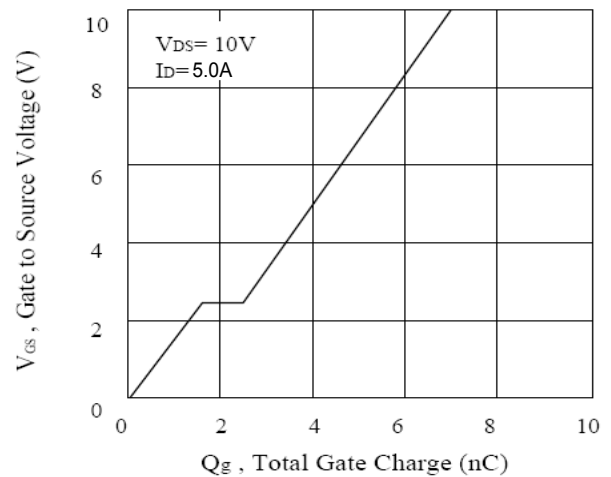
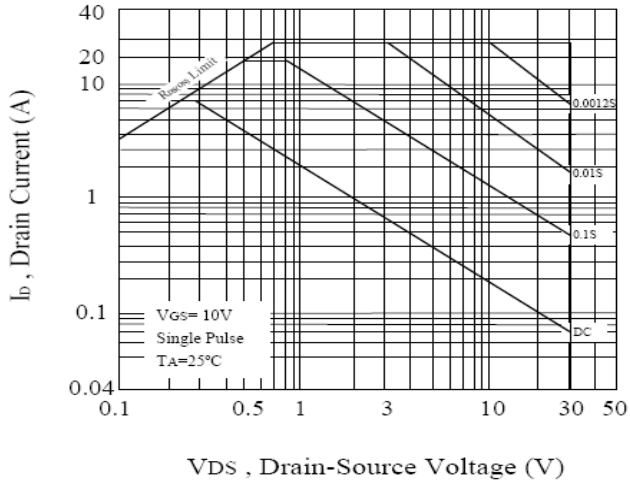

Figure 5. Gate Threshold Variation with Temperature



Characteristics Curve(N-Channel)



V_{DS} , Drain-Source Voltage (V)
Figure 7. Maximum Safe Operating Area

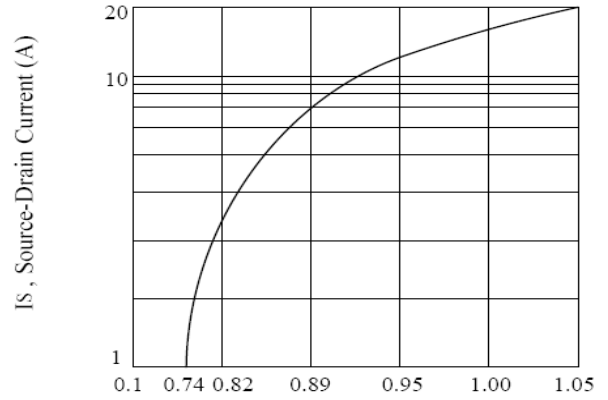

V_{SD} , Body Diode Forward Voltage (V)
Figure 8. Body Diode Forward Voltage Variation with Source Current

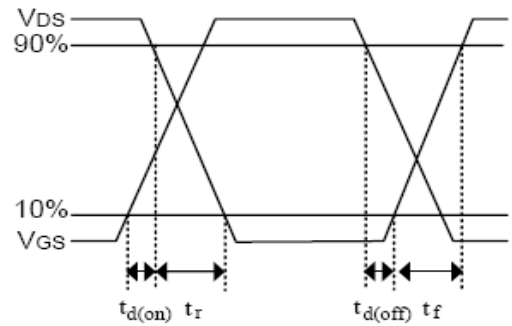
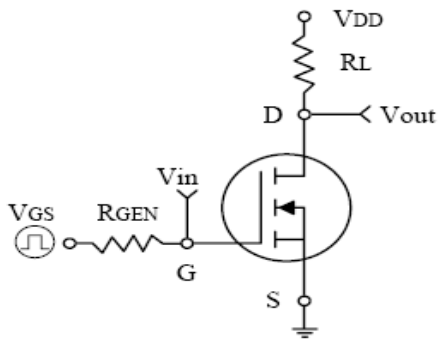

Figure 9. Switching Test Circuit and Switching Waveforms

P-CH Electrical Characteristics (T_A=25°C unless otherwise noted)

Parameter	Symbol	Condition	Min	Typ	Max	Unit
Off Characteristics						
Drain-Source Breakdown Voltage	BV _{DSS}	V _{GS} =0V, I _D =-250μA	-30	-	-	V
Zero Gate Voltage Drain Current	I _{DSS}	V _{DS} =-24V, V _{GS} =0V	-	-	-50	μA
Gate-Body Leakage Current	I _{GSS}	V _{GS} =±20V, V _{DS} =0V	-	-	±100	nA

On Characteristics ^(Note 3)

Gate Threshold Voltage	V _{GS(th)}	V _{DS} =V _{GS} , I _D =-250μA	-1.0	-1.3	-2.0	V
Drain-Source On-State Resistance	R _{DS(on)}	V _{GS} =-10V, I _D =-6.0A	-	42	45	mΩ
		V _{GS} =-4.5V, I _D =-5.0A	-	55	60	mΩ
Forward Transconductance	g _{FS}	V _{DS} =-5V, I _D =-5.0A	10	-	-	S

Dynamic Characteristics ^(Note4)

Input Capacitance	C _{iss}	V _{DS} =-15V, V _{GS} =0V, F=1.0MHz	-	930	-	PF
Output Capacitance	C _{oss}		-	121	-	PF
Reverse Transfer Capacitance	C _{rss}		-	102	-	PF

Switching Characteristics ^(Note 4)

Turn-on Delay Time	t _{d(on)}	V _{DD} =-15V, R _L =5.0Ω V _{GS} =-10V, R _{GEN} =6Ω I _D =-3.0A	-	9.5	-	nS
Turn-on Rise Time	t _r		-	5.4	-	nS
Turn-Off Delay Time	t _{d(off)}		-	42.5	-	nS
Turn-Off Fall Time	t _f		-	13.6	-	nS
Total Gate Charge	Q _g	V _{DS} =-15V, I _D =-3.0A V _{GS} =-10V	-	20	-	nC
Gate-Source Charge	Q _{gs}		-	4.1	-	nC
Gate-Drain Charge	Q _{gd}		-	2.6	-	nC

Drain-Source Diode Characteristics

Diode Forward Voltage ^(Note 3)	V _{SD}	V _{GS} =0V, I _S =-2.0A	-	0.75	-1.0	V
---	-----------------	--	---	------	------	---

Notes:

1. Repetitive Rating: Pulse width limited by maximum junction temperature.
2. Surface Mounted on FR4 Board, t ≤ 10 sec.
3. Pulse Test: Pulse Width ≤ 300μs, Duty Cycle ≤ 2%.
4. Guaranteed by design, not subject to production

Characteristics Curve(P-Channel)

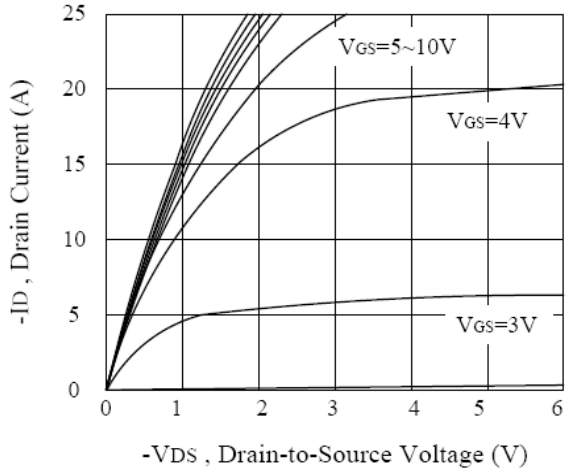

Figure 11. Output Characteristics

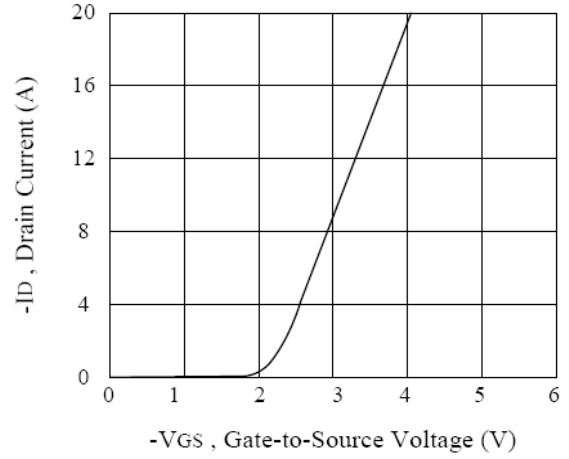

Figure 12. Transfer Characteristics

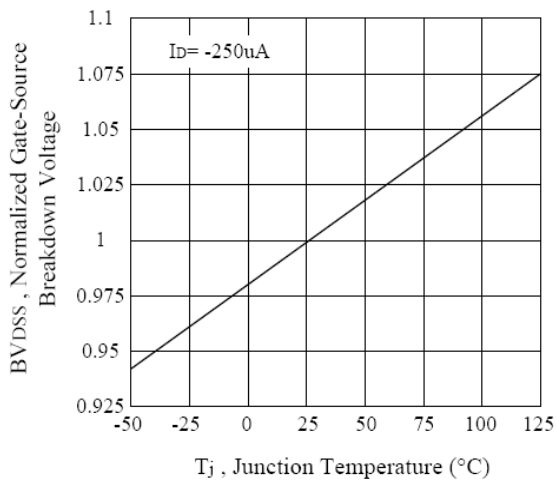

Figure 13. Breakdown Voltage Variation with

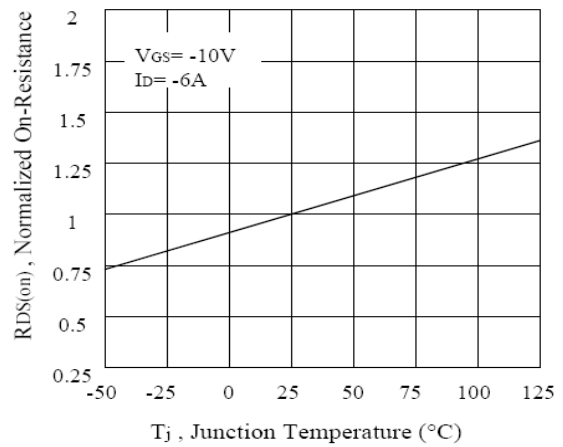

Figure 13. On-Resistance Variation with Temperature

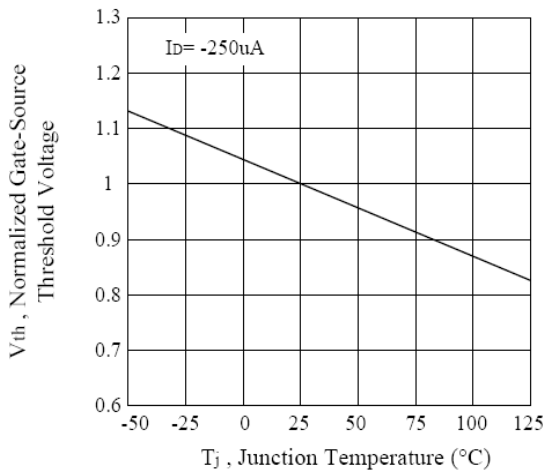

Figure 15. Gate Threshold Variation with Temperature

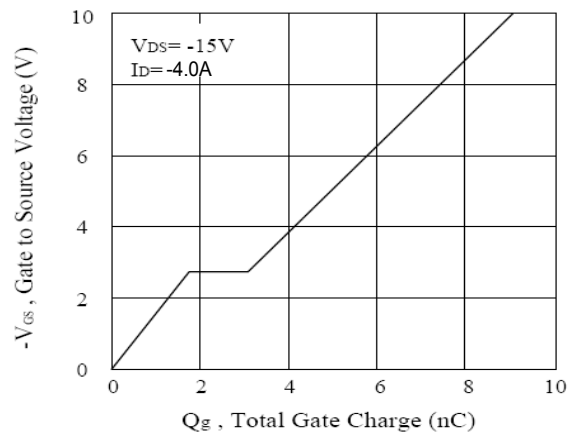
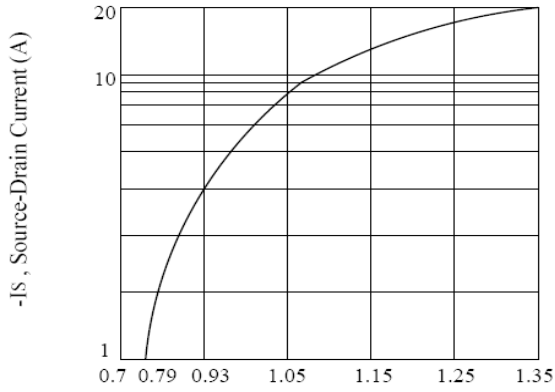
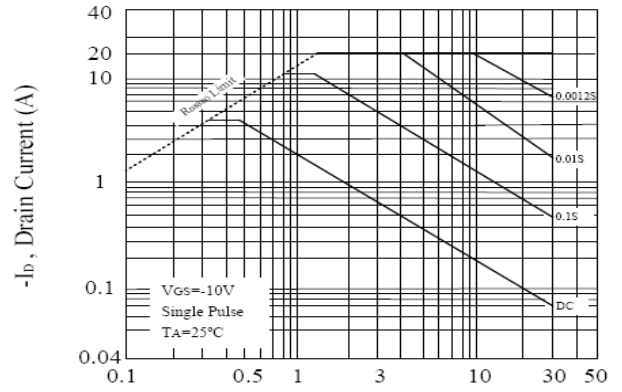

Figure 15. Gate Charge

Characteristics Curve(P-Channel)



$-V_{SD}$, Body Diode Forward Voltage (V)
 Figure 16 Body Diode Forward Voltage Variation with Source Current



$-V_{DS}$, Drain-Source Voltage (V)
 Figure 17. Maximum Safe Operating Area

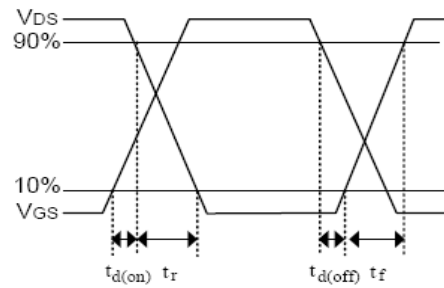
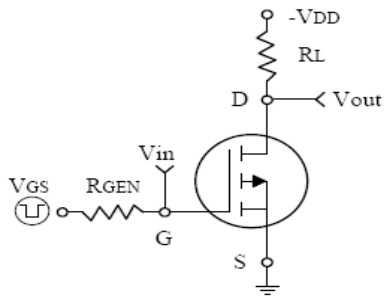
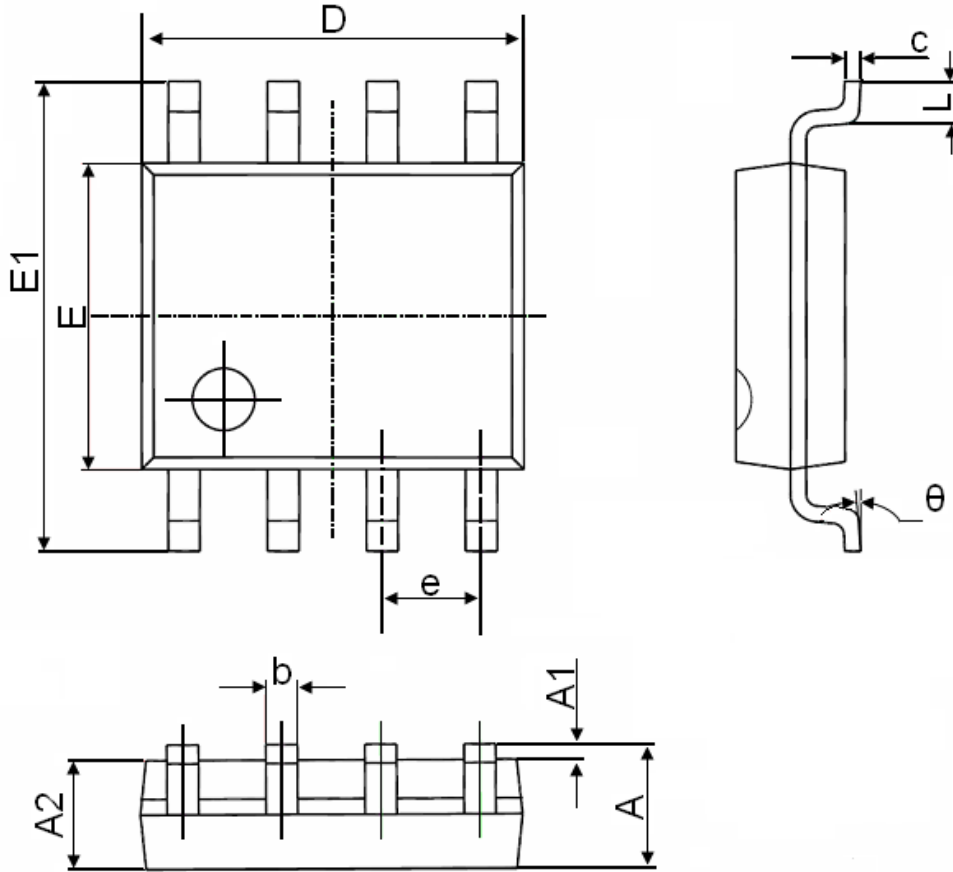

Figure 18 Switching Test Circuit and Switching Waveforms

SOP-8 Package Information



Symbol	Dimensions In Millimeters		Dimensions In Inches	
	Min.	Max.	Min.	Max.
A	1.350	1.750	0.053	0.069
A1	0.100	0.250	0.004	0.010
A2	1.350	1.550	0.053	0.061
b	0.330	0.510	0.013	0.020
c	0.170	0.250	0.006	0.010
D	4.700	5.100	0.185	0.200
E	3.800	4.000	0.150	0.157
E1	5.800	6.200	0.228	0.244
e	1.270(BSC)		0.050(BSC)	
L	0.400	1.270	0.016	0.050
θ	0°	8°	0°	8°