

Surface Mount Ultrafast Rectifier Diode

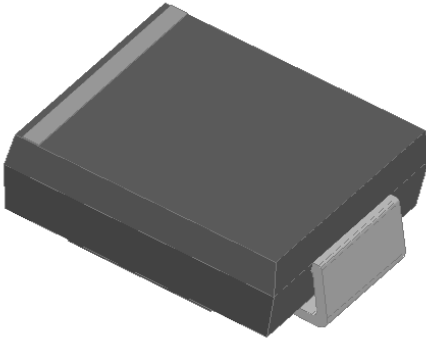

Features

- Ultrafast reverse recovery time
- Low leakage current
- Low switching losses, high efficiency
- High forward surge capability
- Solder dip 260 °C max. 10 s, per JESD 22-B106

Typical Applications

For use in high frequency rectification and freewheeling application in switching mode converters and inverters for consumer, computer and telecommunication.

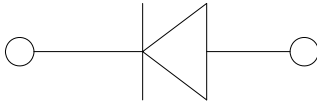

Mechanical Data

- **Package:** DO-214AB (SMC)
Molding compound meets UL 94 V-0 flammability rating, RoHS-compliant, halogen-free
- **Terminals:** Tin plated leads, solderable per J-STD-002 and JESD22-B102
- **Polarity:** Color band denotes the cathode end

■Maximum Ratings (T_a=25°C Unless otherwise specified)

PARAMETER	SYMBOL	UNIT	MURS480
Device marking code			MURS480
Maximum Repetitive Peak Reverse Voltage	V _{RRM}	V	800
Maximum RMS Voltage	V _{RMS}	V	560
Maximum DC blocking Voltage	V _{DC}	V	800
Average Rectified Output Current @60Hz sine wave, Resistance load, TL (FIG.1)	I _o	A	4.0
Forward Surge Current (Non-repetitive) @60Hz Half-sine wave, 1 cycle, T _j =25°C	I _{FSM}	A	100
Forward Surge Current (Non-repetitive) @1ms, square wave, 1 cycle, T _j =25°C			200
Current squared time @1ms≤t≤8.3ms T _j =25°C	I ² t	A ² s	41.5
Storage Temperature	T _{stg}	°C	-55 ~ +150
Junction Temperature	T _j	°C	-55 ~ +150

■Electrical Characteristics (T_a=25°C Unless otherwise specified)

PARAMETER	SYMBOL	UNIT	TEST CONDITIONS	MURS480
Maximum instantaneous forward voltage	V _F	V	I _{FM} =4.0A	1.85
Maximum reverse recovery time	t _{rr}	ns	I _F =0.5A, I _R =1.0A, I _{rr} =0.25A	75
Maximum DC reverse current at rated DC blocking voltage	I _R	μA	T _j =25°C	5
			T _j =125°C	50
Typical junction capacitance	C _j	pF	Measured at 1MHz and Applied Reverse Voltage of 4.0 V.D.C	48



MURS480

Dynamic Characteristics

PARAMETER	SYMBOL	UNIT	TEST CONDITIONS		Min	Typ	Max
Reverse Recovery Time	T_{RR}	ns	$T_j=25^{\circ}\text{C}$	$I_F=1\text{A}, di/dt=-50\text{A}/\mu\text{s}$ $V_{RM}=30\text{V}$	-	51	-
			$T_j=25^{\circ}\text{C}$	$I_F=4\text{A}$ $di/dt=-200\text{A}/\mu\text{s}$ $V_{RM}=400\text{V}$	-	64	-
			$T_j=125^{\circ}\text{C}$		-	114	-
Peak recovery current	I_{RRM}	A	$T_j=25^{\circ}\text{C}$	$I_F=4\text{A}$ $di/dt=-200\text{A}/\mu\text{s}$ $V_{RM}=400\text{V}$	-	7.4	-
			$T_j=125^{\circ}\text{C}$		-	11.2	-
Reverse recovery charge	Q_{rr}	nC	$T_j=25^{\circ}\text{C}$	$I_F=4\text{A}$ $di/dt=-200\text{A}/\mu\text{s}$ $V_{RM}=400\text{V}$	-	235.8	-
			$T_j=125^{\circ}\text{C}$		-	635.8	-
Non-repetitive avalanche energy	E_{AS}	mJ	$T_j=25^{\circ}\text{C}$	$I_R=2.8\text{A}, L=15\text{mH}$	58.8	-	-

Thermal Characteristics ($T_a=25^{\circ}\text{C}$ Unless otherwise specified)

PARAMETER	SYMBOL	UNIT	MURS480
Typical Thermal resistance	$R_{\theta J-A}^{(1)}$	$^{\circ}\text{C}/\text{W}$	55
	$R_{\theta J-L}^{(1)}$		15
	$R_{\theta J-C}^{(1)}$		10

Note(1)

Thermal resistance from junction to ambient and from junction to lead mounted on P.C.B. with 0.6" x 0.6" (16 mm x 16 mm) copper pad areas

Ordering Information (Example)

PREFERRED P/N	PACKAGE CODE	UNIT WEIGHT(g)	MINIMUM PACKAGE(pcs)	INNER BOX QUANTITY(pcs)	OUTER CARTON QUANTITY(pcs)	DELIVERY MODE
MURS480	F1	Approximate 0.248	3000	/	42000	13" reel

Characteristics(Typical)

FIG.1: I_o -TL Curve

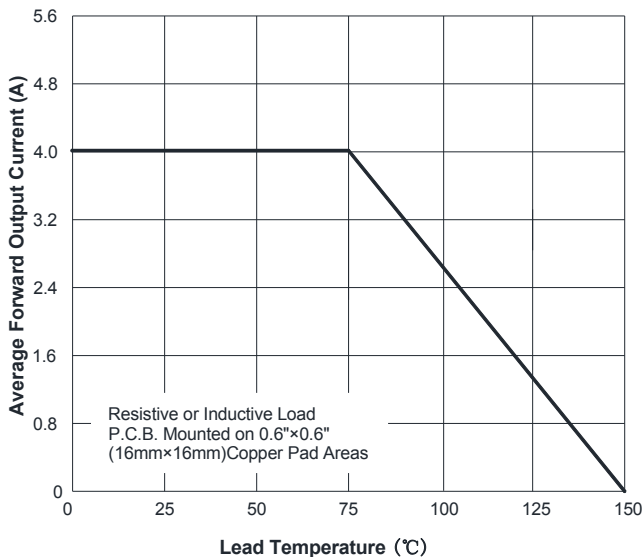

FIG.2: Forward Surge Current Capability

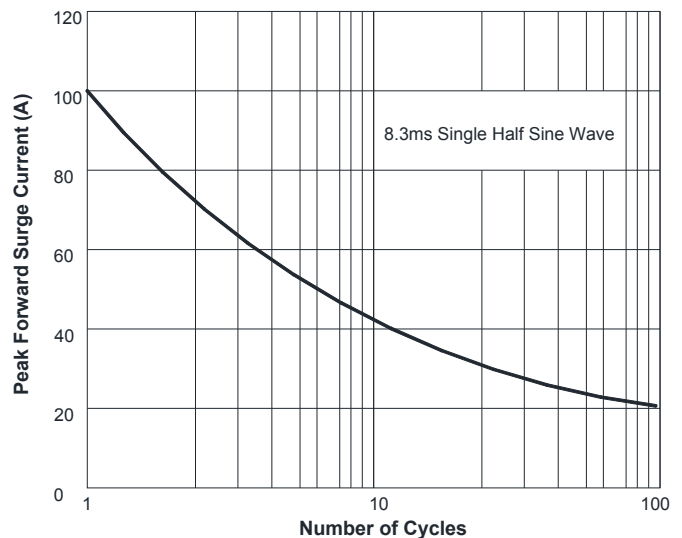

FIG.3: Typical Forward Voltage

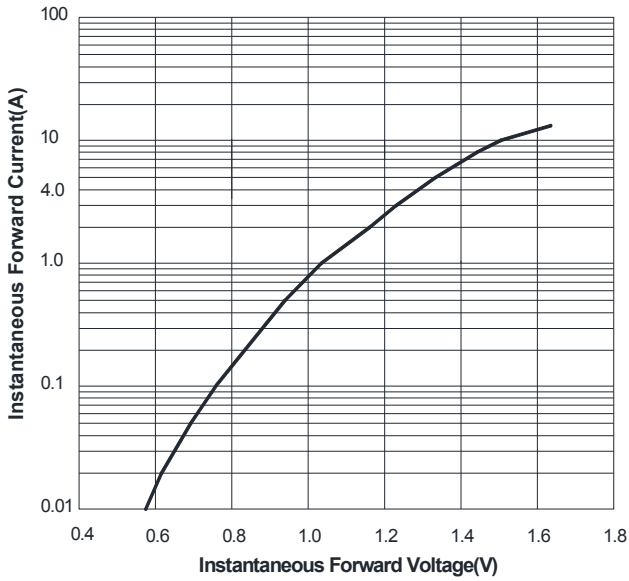

FIG.4: Typical Reverse Characteristics

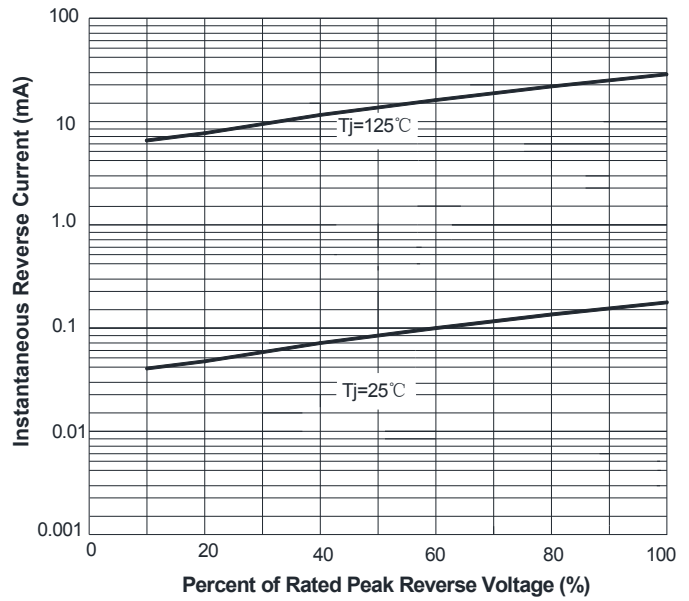
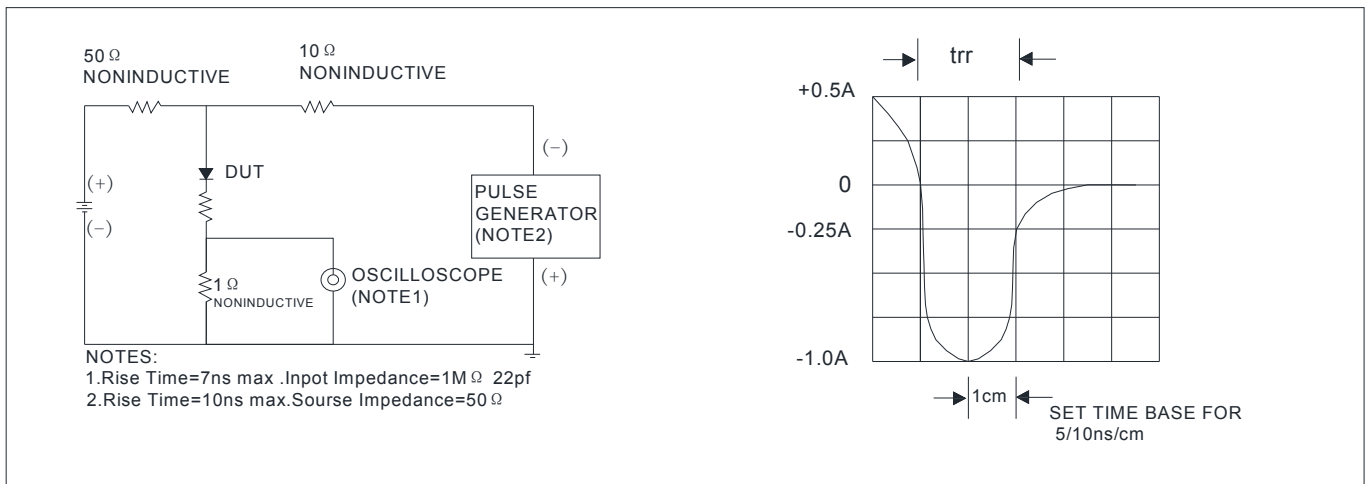
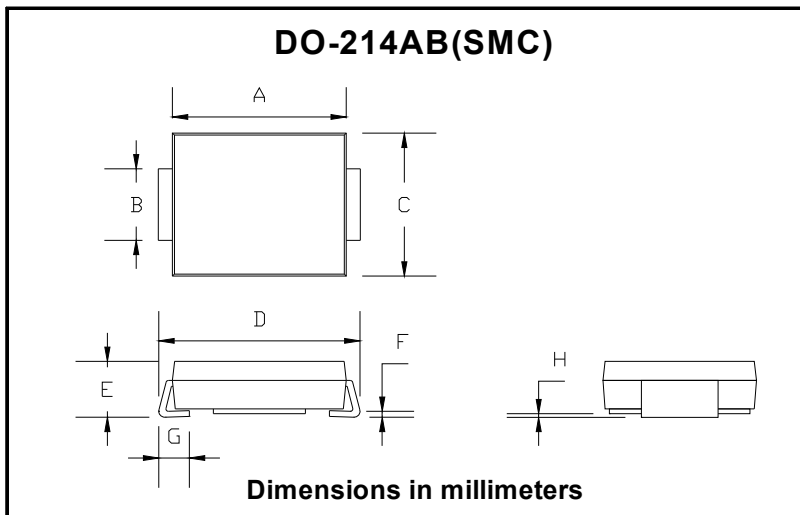

FIG.5: Diagram of circuit and Testing wave form of reverse recovery time



Outline Dimensions



DO-214AB (SMC)		
Dim	Min	Max
A	6.60	7.11
B	2.85	3.27
C	5.59	6.22
D	7.75	8.13
E	1.99	2.61
F	0.15	0.31
G	0.76	1.52
H	0.10	0.20



■ Suggested pad layout

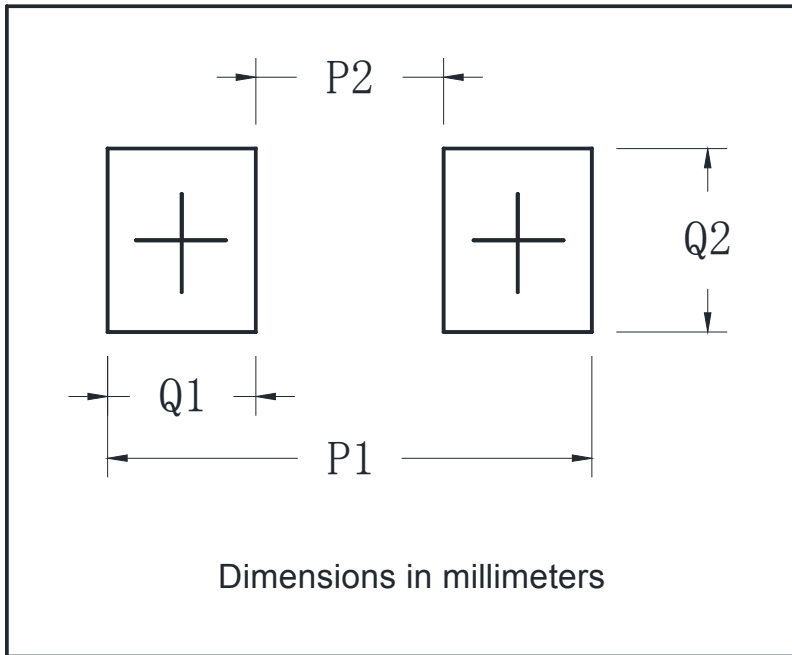

DO-214AB (SMC)	
Dim	Min
P1	9.9
P2	3.84
Q1	3.03
Q2	3.82



MURS480

Disclaimer

The information presented in this document is for reference only. Yangzhou Yangjie Electronic Technology Co., Ltd. reserves the right to make changes without notice for the specification of the products displayed herein to improve reliability, function or design or otherwise.

The product listed herein is designed to be used with ordinary electronic equipment or devices, and not designed to be used with equipment or devices which require high level of reliability and the malfunction of which would directly endanger human life (such as medical instruments, transportation equipment, aerospace machinery, nuclear-reactor controllers, fuel controllers and other safety devices), Yangjie or anyone on its behalf, assumes no responsibility or liability for any damages resulting from such improper use of sale.

This publication supersedes & replaces all information previously supplied. For additional information, please visit our website [http:// www.21yangjie.com](http://www.21yangjie.com) , or consult your nearest Yangjie's sales office for further assistance.