



# SGM8742

## 45ns, Low-Power, 3V/5V, Rail-to-Rail Input Single-Supply Comparator

---

### GENERAL DESCRIPTION

The SGM8742 is a dual, rail-to-rail input, single-supply comparator with typical 305 $\mu$ A power supply current. The comparator operates from a wide range of 2.7V to 5.5V supply voltage and features high-speed response, and rail-to-rail input range.

The SGM8742 is optimized for low-power, single-supply operation with greater than rail-to-rail input operation. The push-pull output stage supports rail-to-rail output swing within 0.1V of either supply rail without external pull-up circuitry, and interfaces with CMOS/TTL logic. All input and output pins have a continuous short-circuit protection to each rail.

The SGM8742 is available in Green SOIC-8 and MSOP-8 packages. It is rated over the -40°C to +85°C temperature range.

### FEATURES

- **Fast Propagation Delay:**  
45ns (TYP) at 10mV Overdrive
- **Low Quiescent Current:**  
305 $\mu$ A (TYP) at  $V_S = 3V$
- **Wide Single-Supply Voltage Range: 2.7V to 5.5V**
- **Optimized for 3V/5V Applications**
- **Rail-to-Rail Input**
- **Low Offset Voltage: 0.9mV (TYP)**
- **Output Swing to within 200mV from Rails with 4mA Output Current**
- **CMOS/TTL-Compatible Output**
- **Internal Hysteresis for Clean Switching**
- **-40°C to +85°C Operating Temperature Range**
- **Available in Green SOIC-8 and MSOP-8 Packages**

### APPLICATIONS

Portable and Battery-Powered Applications

3V/5V Applications

Threshold Detectors

Line Receivers

**PACKAGE/ORDERING INFORMATION**

MODEL	PACKAGE DESCRIPTION	SPECIFIED TEMPERATURE RANGE	ORDERING NUMBER	PACKAGE MARKING	PACKING OPTION
SGM8742	SOIC-8	-40°C to +85°C	SGM8742YS8G/TR	SGM 8742YS8 XXXXX	Tape and Reel, 2500
	MSOP-8	-40°C to +85°C	SGM8742YMS8G/TR	SGM8742 YMS8 XXXXX	Tape and Reel, 4000

**MARKING INFORMATION**

NOTE: XXXXX = Date Code and Vendor Code.

**SOIC-8/MSOP-8**

**XXXXX**

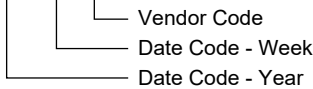

Green (RoHS & HSF): SG Micro Corp defines "Green" to mean Pb-Free (RoHS compatible) and free of halogen substances. If you have additional comments or questions, please contact your SGMICRO representative directly.

**ABSOLUTE MAXIMUM RATINGS**

Supply Voltage, +V <sub>S</sub> to -V <sub>S</sub> .....	6V
V <sub>IN</sub> Differential .....	±2.5V
Voltage at Input/Output Pins .....	(-V <sub>S</sub> ) - 0.3V to (+V <sub>S</sub> ) + 0.3V
Junction Temperature .....	+150°C
Storage Temperature Range .....	-65°C to +150°C
Lead Temperature (Soldering, 10s) .....	+260°C
ESD Susceptibility	
HBM .....	6000V
MM .....	400V

**RECOMMENDED OPERATING CONDITIONS**

Operating Temperature Range .....	-40°C to +85°C
-----------------------------------	----------------

**OVERSTRESS CAUTION**

Stresses beyond those listed in Absolute Maximum Ratings may cause permanent damage to the device. Exposure to absolute maximum rating conditions for extended periods may affect reliability. Functional operation of the device at any conditions beyond those indicated in the Recommended Operating Conditions section is not implied.

**ESD SENSITIVITY CAUTION**

This integrated circuit can be damaged by ESD if you don't pay attention to ESD protection. SGMICRO recommends that all integrated circuits be handled with appropriate precautions. Failure to observe proper handling and installation procedures

can cause damage. ESD damage can range from subtle performance degradation to complete device failure. Precision integrated circuits may be more susceptible to damage because very small parametric changes could cause the device not to meet its published specifications.

**DISCLAIMER**

SG Micro Corp reserves the right to make any change in circuit design, or specifications without prior notice.

**PIN CONFIGURATIONS**

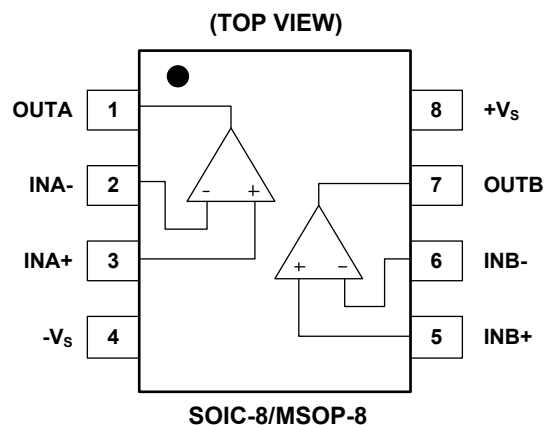

**ELECTRICAL CHARACTERISTICS**(V<sub>S</sub> = 5.0V, V<sub>CM</sub> = 0V, C<sub>L</sub> = 15pF, typical values are at T<sub>A</sub> = +25°C, unless otherwise noted.)

PARAMETER	SYMBOL	CONDITIONS	MIN	TYP	MAX	UNITS
Operating Supply Voltage	V <sub>S</sub>		2.7		5.5	V
Input Common Mode Voltage Range	V <sub>CM</sub>		-0.1		V <sub>S</sub> + 0.1	V
Input Offset Voltage	V <sub>OS</sub>	V <sub>S</sub> = 5V, V <sub>CM</sub> = 0V		0.9	5	mV
		-40°C ≤ T <sub>A</sub> ≤ +85°C			5.8	
Input Hysteresis	V <sub>HYST</sub>	V <sub>S</sub> = 5V, V <sub>CM</sub> = 0V		2.8		mV
Output Short-Circuit Current	I <sub>SOURCE</sub>	V <sub>S</sub> = 5V, Out to V <sub>S</sub> /2	21	33		mA
		-40°C ≤ T <sub>A</sub> ≤ +85°C	17			
	I <sub>SINK</sub>	V <sub>S</sub> = 5V, Out to V <sub>S</sub> /2		-32	-20	
		-40°C ≤ T <sub>A</sub> ≤ +85°C			-15	
Common Mode Rejection Ratio	CMRR	V <sub>S</sub> = 5V, V <sub>CM</sub> = 0V to 5V	60	78		dB
		-40°C ≤ T <sub>A</sub> ≤ +85°C	54			
Power Supply Rejection Ratio	PSRR	V <sub>CM</sub> = 0V, V <sub>S</sub> = 2.7V to 5.5V	59	77		dB
		-40°C ≤ T <sub>A</sub> ≤ +85°C	55			
Output Voltage Swing from Rail	V <sub>OH</sub>	V <sub>S</sub> = 5V, I <sub>OUT</sub> = 4mA		198	450	mV
		-40°C ≤ T <sub>A</sub> ≤ +85°C			480	
	V <sub>OL</sub>	V <sub>S</sub> = 5V, I <sub>OUT</sub> = -4mA		180	231	
		-40°C ≤ T <sub>A</sub> ≤ +85°C			258	
Supply Current	I <sub>S</sub>	V <sub>S</sub> = 3V, I <sub>OUT</sub> = 0		305	400	μA
		-40°C ≤ T <sub>A</sub> ≤ +85°C			445	
		V <sub>S</sub> = 5V, I <sub>OUT</sub> = 0		322	440	
		-40°C ≤ T <sub>A</sub> ≤ +85°C			500	
Propagation Delay (High to Low)		V <sub>S</sub> = 3V, Overdrive = 10mV		45		ns
		V <sub>S</sub> = 3V, Overdrive = 100mV		20		
Propagation Delay (Low to High)		V <sub>S</sub> = 3V, Overdrive = 10mV		35		ns
		V <sub>S</sub> = 3V, Overdrive = 100mV		25		
Rise Time	t <sub>RISE</sub>	V <sub>S</sub> = 3V, Overdrive = 10mV		9		ns
		V <sub>S</sub> = 3V, Overdrive = 100mV		8		
Fall Time	t <sub>FALL</sub>	V <sub>S</sub> = 3V, Overdrive = 10mV		8		ns
		V <sub>S</sub> = 3V, Overdrive = 100mV		5		

TYPICAL PERFORMANCE CHARACTERISTICS

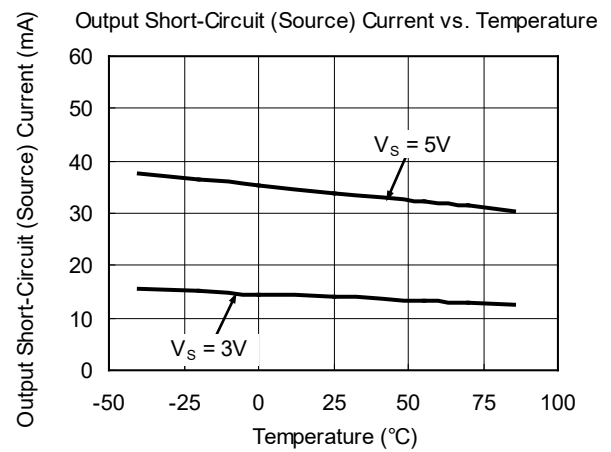
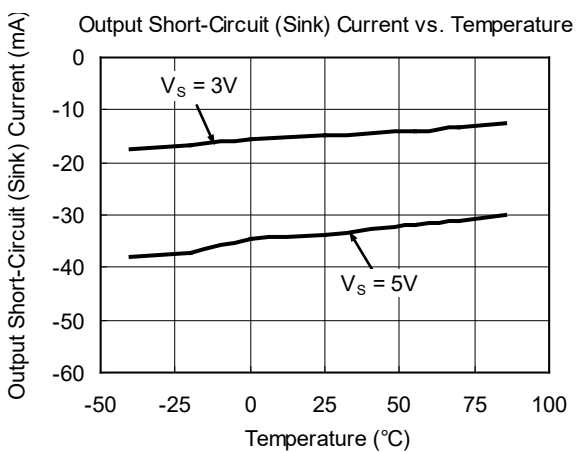
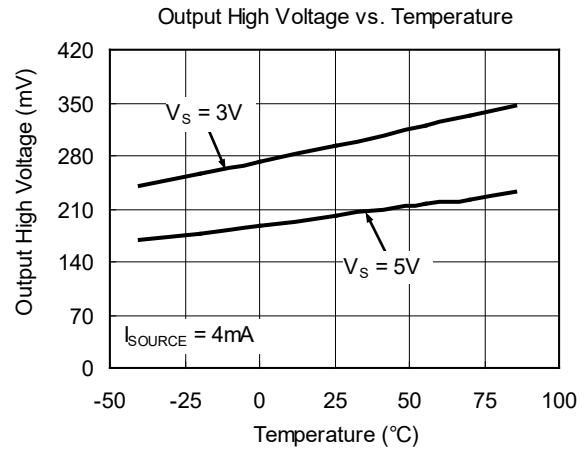
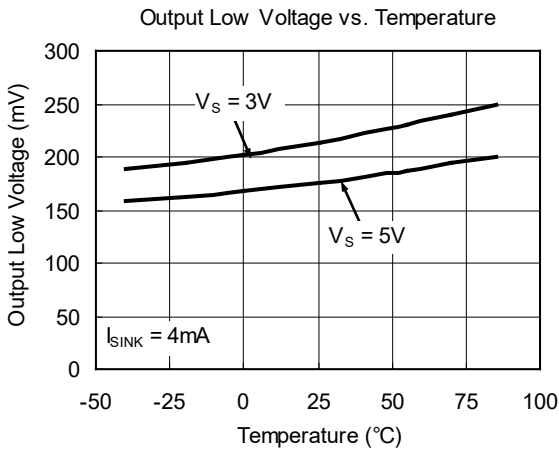
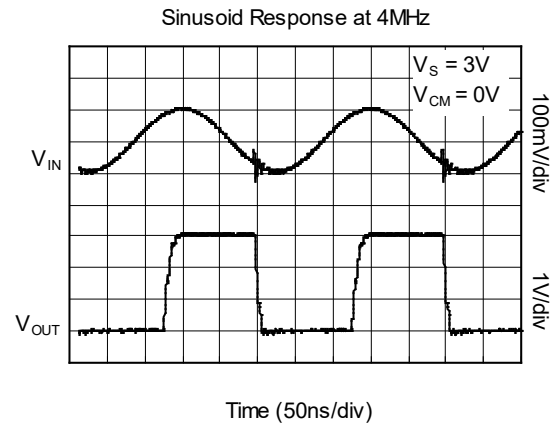
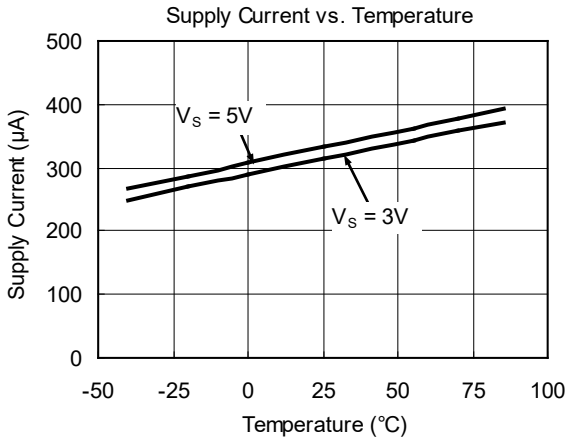

TYPICAL PERFORMANCE CHARACTERISTICS (continued)

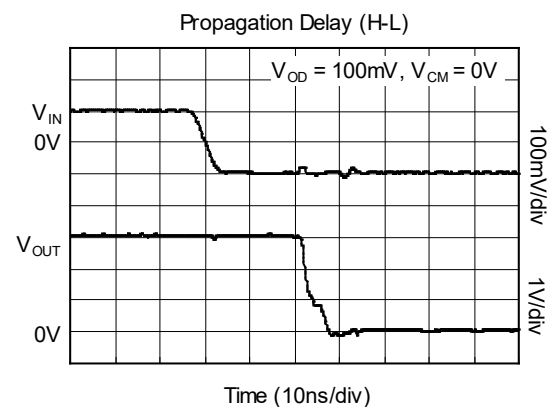
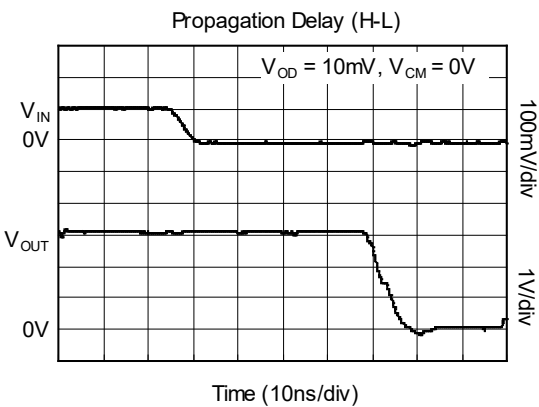
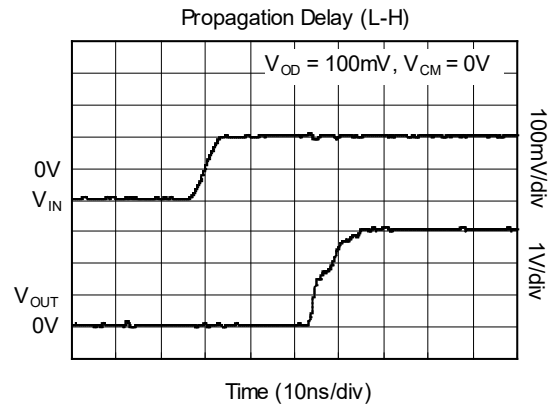
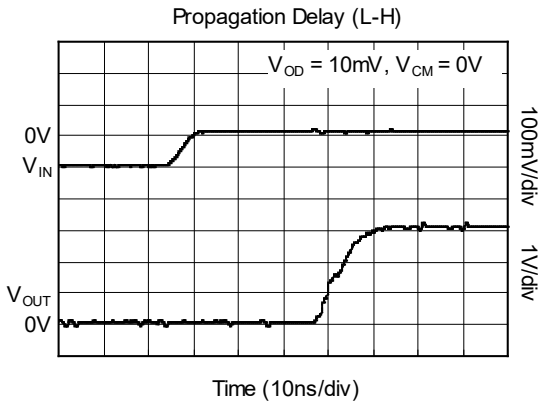
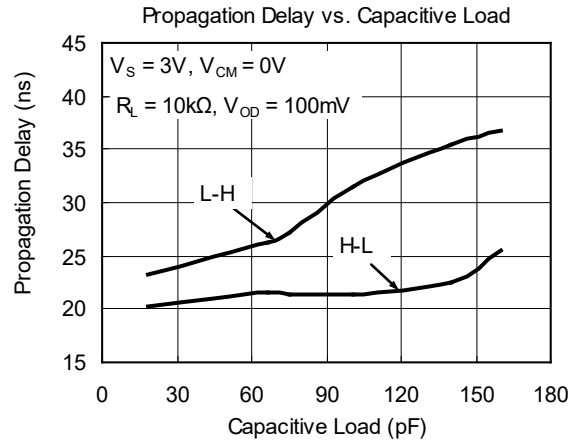
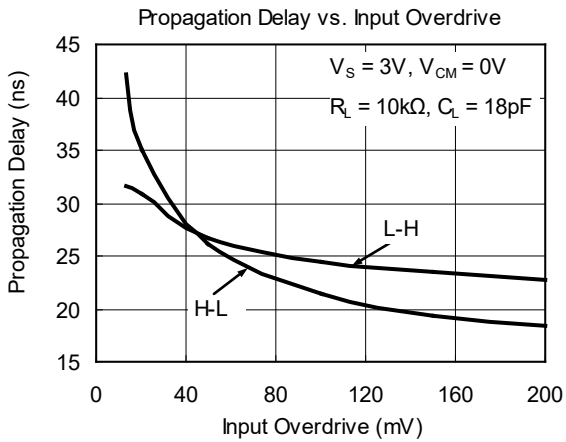

**TYPICAL PERFORMANCE CHARACTERISTICS (continued)**

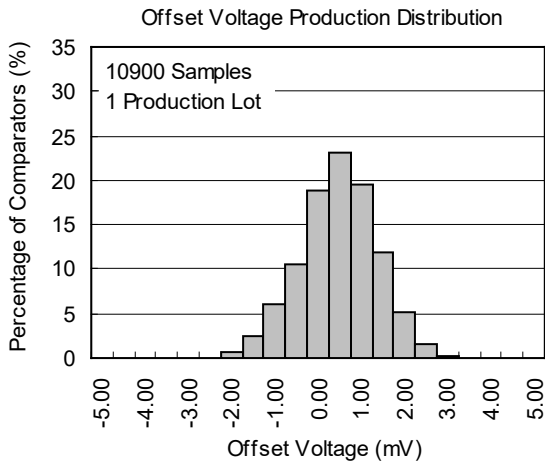

**REVISION HISTORY**

NOTE: Page numbers for previous revisions may differ from page numbers in the current version.

Changes from Original (APRIL 2015) to REV.A	Page
Changed from product preview to production data.....	All

PACKAGE OUTLINE DIMENSIONS

SOIC-8

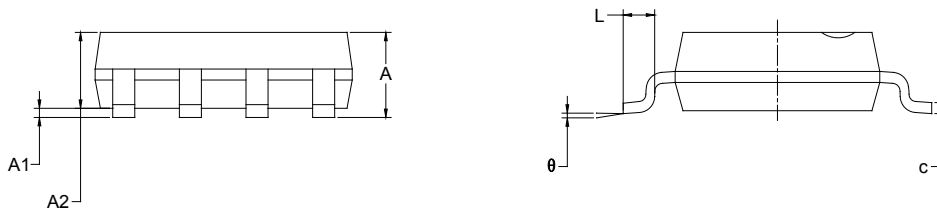
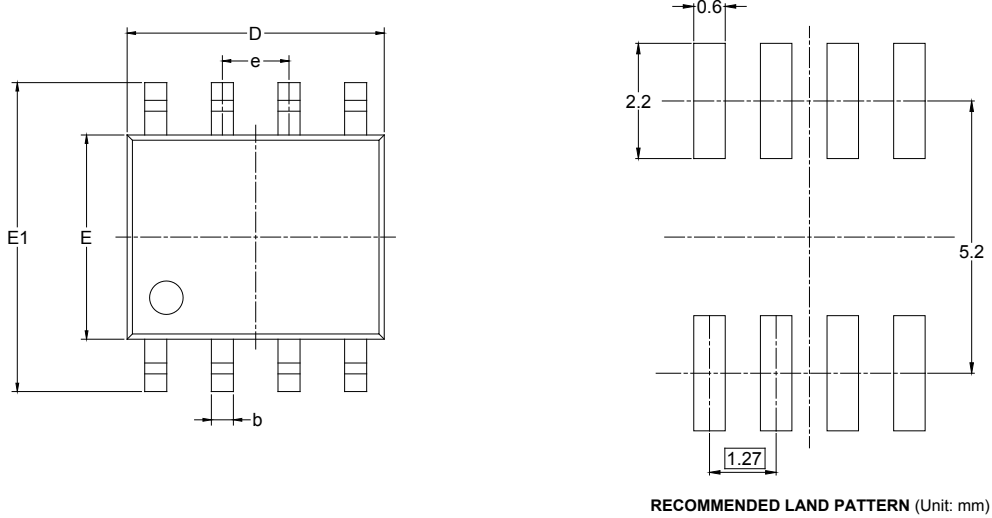

Symbol	Dimensions In Millimeters		Dimensions In Inches	
	MIN	MAX	MIN	MAX
A	1.350	1.750	0.053	0.069
A1	0.100	0.250	0.004	0.010
A2	1.350	1.550	0.053	0.061
b	0.330	0.510	0.013	0.020
c	0.170	0.250	0.006	0.010
D	4.700	5.100	0.185	0.200
E	3.800	4.000	0.150	0.157
E1	5.800	6.200	0.228	0.244
e	1.27 BSC		0.050 BSC	
L	0.400	1.270	0.016	0.050
θ	0°	8°	0°	8°

PACKAGE OUTLINE DIMENSIONS

MSOP-8



RECOMMENDED LAND PATTERN (Unit: mm)

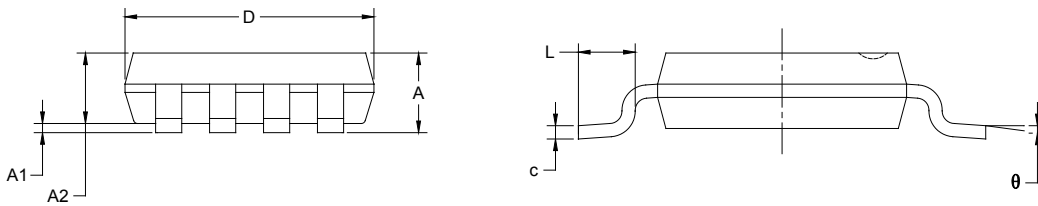

Symbol	Dimensions In Millimeters		Dimensions In Inches	
	MIN	MAX	MIN	MAX
A	0.820	1.100	0.032	0.043
A1	0.020	0.150	0.001	0.006
A2	0.750	0.950	0.030	0.037
b	0.250	0.380	0.010	0.015
c	0.090	0.230	0.004	0.009
D	2.900	3.100	0.114	0.122
E	2.900	3.100	0.114	0.122
E1	4.750	5.050	0.187	0.199
e	0.650 BSC		0.026 BSC	
L	0.400	0.800	0.016	0.031
θ	0°	6°	0°	6°



## TAPE AND REEL INFORMATION

### REEL DIMENSIONS



### TAPE DIMENSIONS



NOTE: The picture is only for reference. Please make the object as the standard.

### KEY PARAMETER LIST OF TAPE AND REEL

Package Type	Reel Diameter	Reel Width W1 (mm)	A0 (mm)	B0 (mm)	K0 (mm)	P0 (mm)	P1 (mm)	P2 (mm)	W (mm)	Pin1 Quadrant
SOIC-8	13"	12.4	6.40	5.40	2.10	4.0	8.0	2.0	12.0	Q1
MSOP-8	13"	12.4	5.20	3.30	1.50	4.0	8.0	2.0	12.0	Q1

DD0001

# PACKAGE INFORMATION

## CARTON BOX DIMENSIONS



NOTE: The picture is only for reference. Please make the object as the standard.

## KEY PARAMETER LIST OF CARTON BOX

Reel Type	Length (mm)	Width (mm)	Height (mm)	Pizza/Carton
13"	386	280	370	5

DD0002