



SGM8740

45ns, Low-Power, 3V/5V, Rail-to-Rail Input Single-Supply Comparator

GENERAL DESCRIPTION

The SGM8740 is a single, rail-to-rail input, single-supply comparator with typical 155 μ A power supply current. The comparator operates from a wide range of 2.7V to 5.5V supply voltage and features high-speed response, and rail-to-rail input range.

The SGM8740 is optimized for low-power, single-supply operation with greater than rail-to-rail input operation. The output stage pulls to within 0.1V of either supply rail without external pull-up circuitry, and interfaces with CMOS/TTL logic. All input and output pins have a continuous short-circuit protection to each rail.

The SGM8740 is available in Green SOT-23-5 and SC70-5 packages. It is rated over the -40°C to +85°C temperature range.

FEATURES

- **Fast Propagation Delay:**
45ns (TYP) at 10mV Overdrive
- **Low Quiescent Current:**
155 μ A (TYP) at $V_S = 3V$
- **Wide Single-Supply Voltage Range: 2.7V to 5.5V**
- **Optimized for 3V/5V Applications**
- **Rail-to-Rail Input**
- **Low Offset Voltage: 0.9mV (TYP)**
- **Output Swing to within 200mV from Rails with 4mA Output Current**
- **CMOS/TTL-Compatible Output**
- **Internal Hysteresis for Clean Switching**
- **-40°C to +85°C Operating Temperature Range**
- **Available in Green SOT-23-5 and SC70-5 Packages**

APPLICATIONS

Portable and Battery-Powered Applications

3V/5V Systems

Threshold Detectors

Line Receivers

PACKAGE/ORDERING INFORMATION

MODEL	PACKAGE DESCRIPTION	SPECIFIED TEMPERATURE RANGE	ORDERING NUMBER	PACKAGE MARKING	PACKING OPTION
SGM8740	SOT-23-5	-40°C to +85°C	SGM8740YN5G/TR	SL5XX	Tape and Reel, 3000
	SC70-5	-40°C to +85°C	SGM8740YC5G/TR	SK7XX	Tape and Reel, 3000

MARKING INFORMATION

NOTE: XX = Date Code.

SOT-23-5/SC70-5

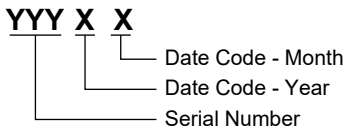

Green (RoHS & HSF): SG Micro Corp defines "Green" to mean Pb-Free (RoHS compatible) and free of halogen substances. If you have additional comments or questions, please contact your SGMICRO representative directly.

ABSOLUTE MAXIMUM RATINGS

Supply Voltage, +V _S to -V _S	6V
V _{IN} Differential	±2.5V
Voltage at Input/Output Pins	(-V _S) - 0.3V to (+V _S) + 0.3V
Junction Temperature	+150°C
Storage Temperature Range	-65°C to +150°C
Lead Temperature (Soldering, 10s)	+260°C
ESD Susceptibility	
HBM	6000V
MM	400V

RECOMMENDED OPERATING CONDITIONS

Operating Temperature Range	-40°C to +85°C
-----------------------------------	----------------

OVERSTRESS CAUTION

Stresses beyond those listed in Absolute Maximum Ratings may cause permanent damage to the device. Exposure to absolute maximum rating conditions for extended periods may affect reliability. Functional operation of the device at any conditions beyond those indicated in the Recommended Operating Conditions section is not implied.

ESD SENSITIVITY CAUTION

This integrated circuit can be damaged by ESD if you don't pay attention to ESD protection. SGMICRO recommends that all integrated circuits be handled with appropriate precautions.

Failure to observe proper handling and installation procedures can cause damage. ESD damage can range from subtle performance degradation to complete device failure. Precision integrated circuits may be more susceptible to damage because very small parametric changes could cause the device not to meet its published specifications.

DISCLAIMER

SG Micro Corp reserves the right to make any change in circuit design, or specifications without prior notice.

PIN CONFIGURATIONS

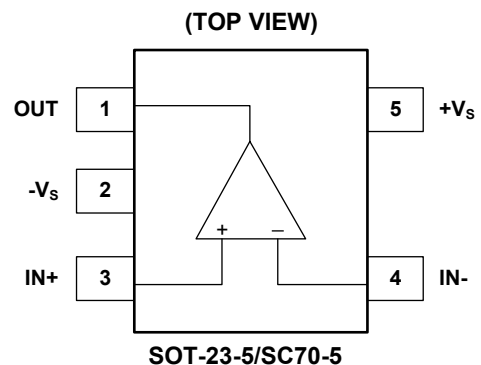

ELECTRICAL CHARACTERISTICS

(V_S = 5.0V, V_{CM} = 0V, C_L = 15pF, typical values are at T_A = +25°C, unless otherwise noted.)

PARAMETER	SYMBOL	CONDITIONS	MIN	TYP	MAX	UNITS
Operating Supply Voltage ⁽¹⁾	V _S		2.7		5.5	V
Input Common Mode Voltage Range ⁽²⁾	V _{CM}		-0.1		V _S + 0.1	V
Input Offset Voltage	V _{OS}	V _S = 5V, V _{CM} = 0V		0.9	5	mV
		-40°C ≤ T _A ≤ +85°C			5.8	
Input Hysteresis ⁽⁴⁾	V _{HYST}	V _S = 5V, V _{CM} = 0V		2.8		mV
Output Short-Circuit Current	I _{SOURCE}	V _S = 5V, Out to V _S /2	21	33		mA
		-40°C ≤ T _A ≤ +85°C	17			
	I _{SINK}	V _S = 5V, Out to V _S /2		-32	-20	
		-40°C ≤ T _A ≤ +85°C			-15	
Common Mode Rejection Ratio	CMRR	V _S = 5V, V _{CM} = 0V to 5V	60	78		dB
		-40°C ≤ T _A ≤ +85°C	54			
Power Supply Rejection Ratio	PSRR	V _{CM} = 0V, V _S = 2.7V to 5.5V	59	77		dB
		-40°C ≤ T _A ≤ +85°C	55			
Output Voltage Swing from Rail	V _{OH}	V _S = 5V, I _{OUT} = 4mA		198	450	mV
		-40°C ≤ T _A ≤ +85°C			480	
	V _{OL}	V _S = 5V, I _{OUT} = -4mA		180	231	
		-40°C ≤ T _A ≤ +85°C			258	
Supply Current	I _S	V _S = 3V, I _{OUT} = 0		155	215	μA
		-40°C ≤ T _A ≤ +85°C			250	
		V _S = 5V, I _{OUT} = 0		164	230	
		-40°C ≤ T _A ≤ +85°C			270	
Propagation Delay (High to Low)		V _S = 3V, Overdrive = 10mV		45		ns
		V _S = 3V, Overdrive = 100mV		20		
Propagation Delay (Low to High)		V _S = 3V, Overdrive = 10mV		35		ns
		V _S = 3V, Overdrive = 100mV		25		
Rise Time	t _{RISE}	V _S = 3V, Overdrive = 10mV		9		ns
		V _S = 3V, Overdrive = 100mV		8		
Fall Time	t _{FALL}	V _S = 3V, Overdrive = 10mV		8		ns
		V _S = 3V, Overdrive = 100mV		5		

TYPICAL PERFORMANCE CHARACTERISTICS

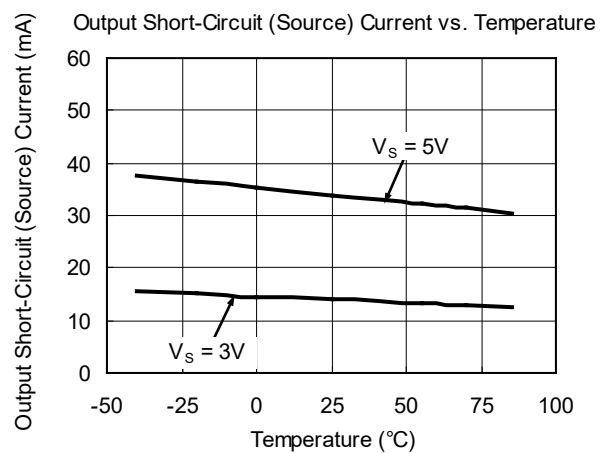
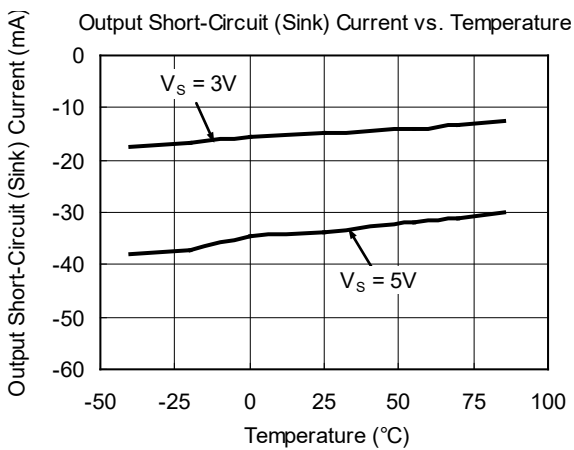
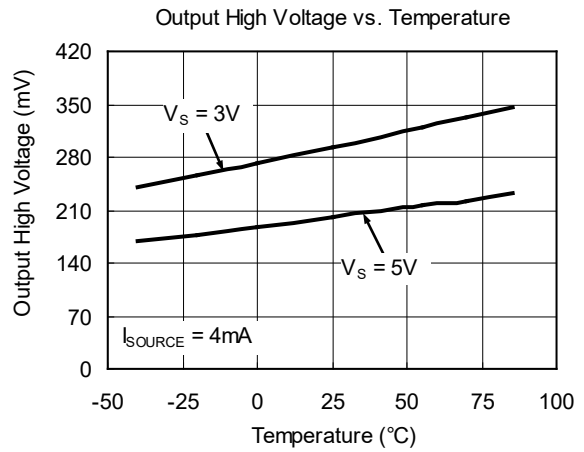
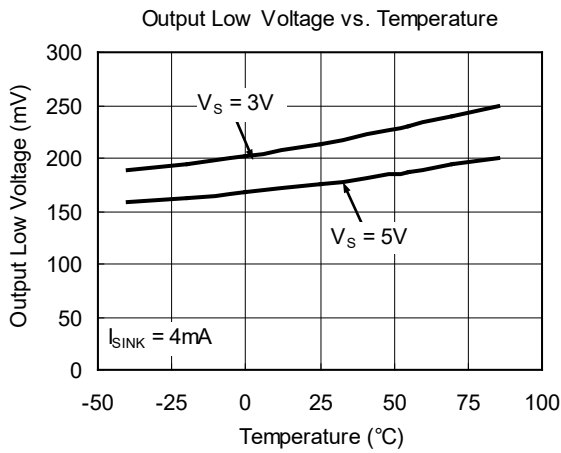
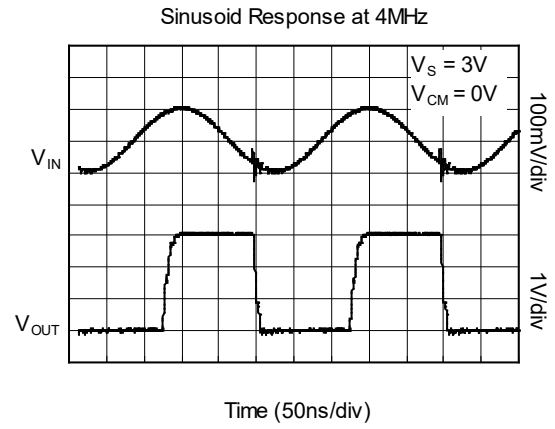
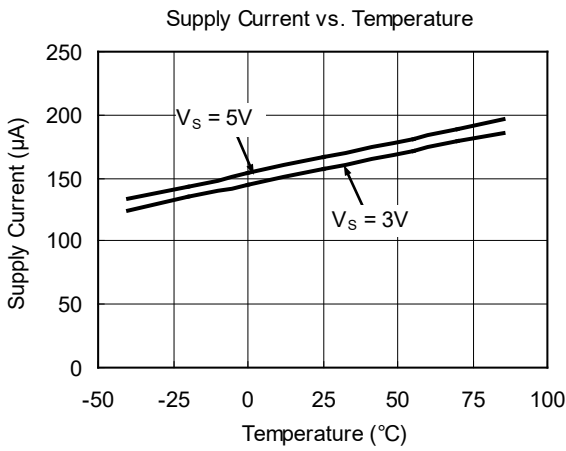

TYPICAL PERFORMANCE CHARACTERISTICS (continued)

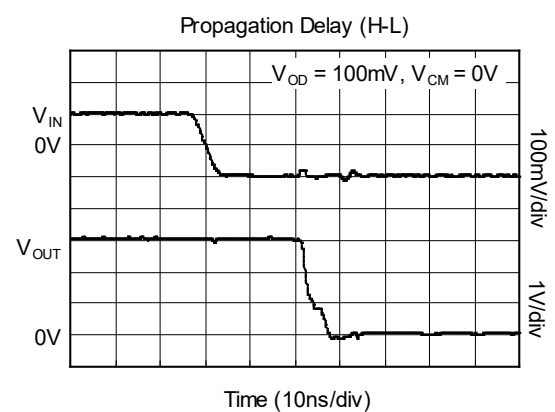
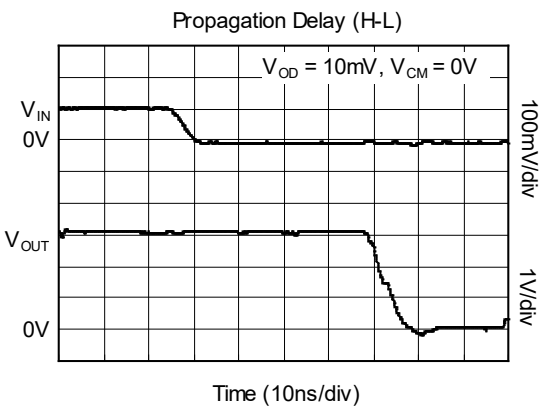
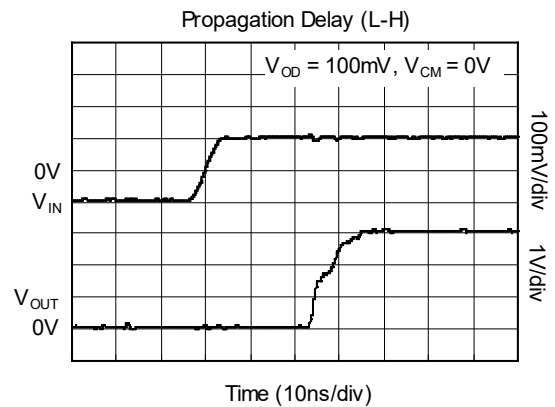
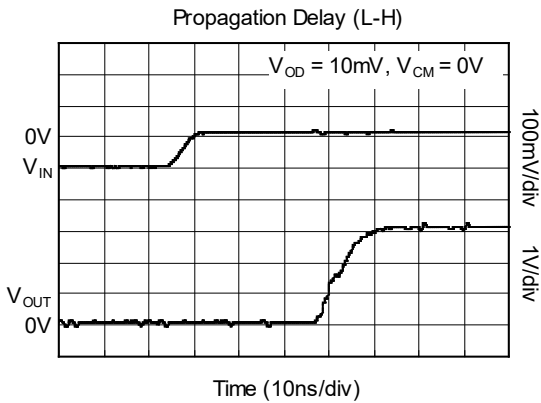
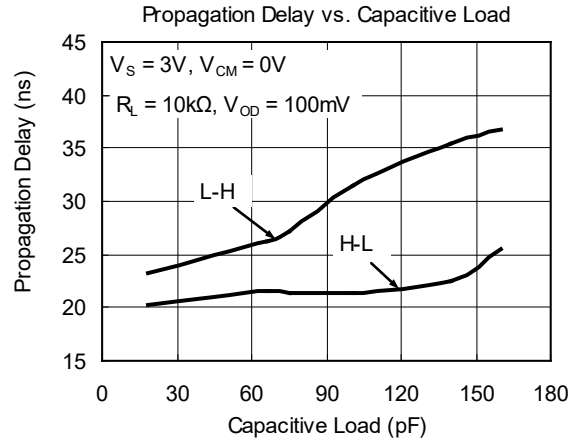
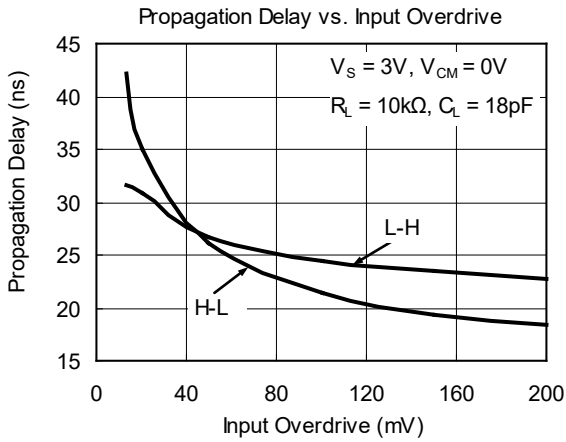

TYPICAL PERFORMANCE CHARACTERISTICS (continued)

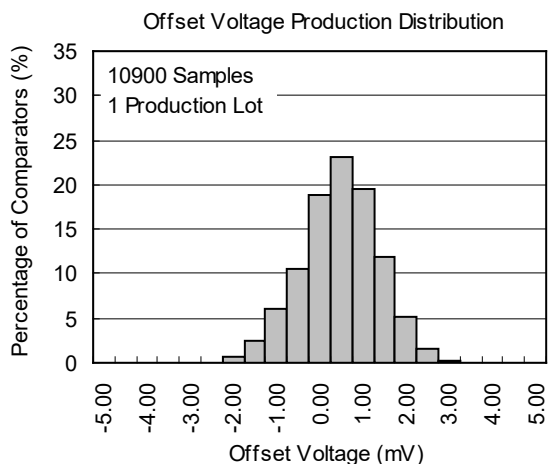

REVISION HISTORY

NOTE: Page numbers for previous revisions may differ from page numbers in the current version.

Changes from Original (APRIL 2015) to REV.A	Page
Changed from product preview to production data.....	All

PACKAGE OUTLINE DIMENSIONS

SOT-23-5

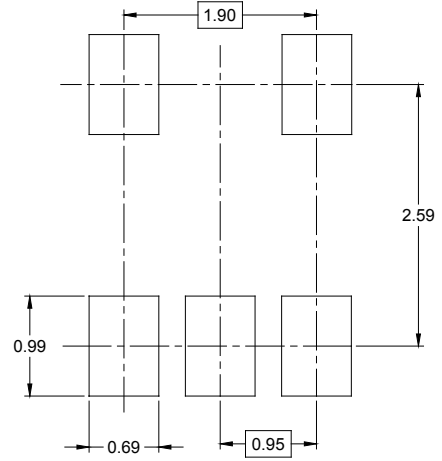
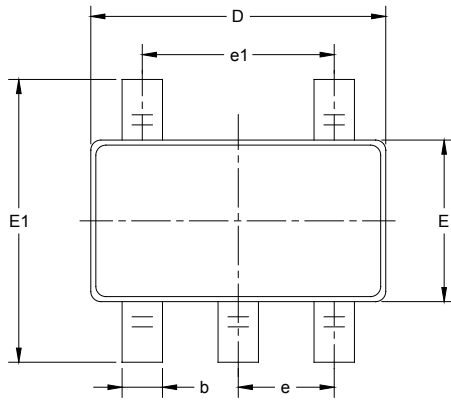

RECOMMENDED LAND PATTERN (Unit: mm)

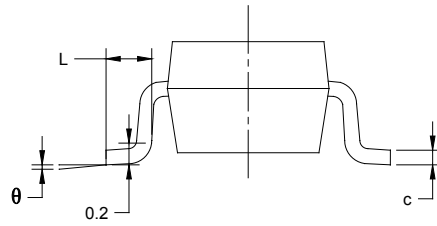
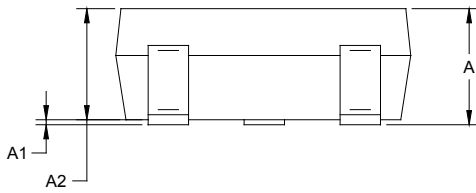

Symbol	Dimensions In Millimeters		Dimensions In Inches	
	MIN	MAX	MIN	MAX
A	1.050	1.250	0.041	0.049
A1	0.000	0.100	0.000	0.004
A2	1.050	1.150	0.041	0.045
b	0.300	0.500	0.012	0.020
c	0.100	0.200	0.004	0.008
D	2.820	3.020	0.111	0.119
E	1.500	1.700	0.059	0.067
E1	2.650	2.950	0.104	0.116
e	0.950 BSC		0.037 BSC	
e1	1.900 BSC		0.075 BSC	
L	0.300	0.600	0.012	0.024
θ	0°	8°	0°	8°

PACKAGE OUTLINE DIMENSIONS

SC70-5

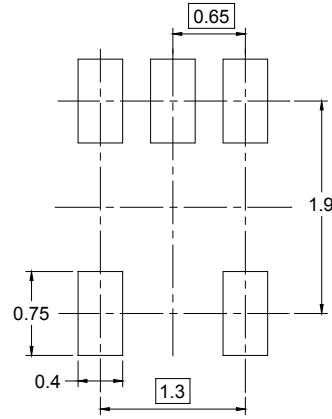
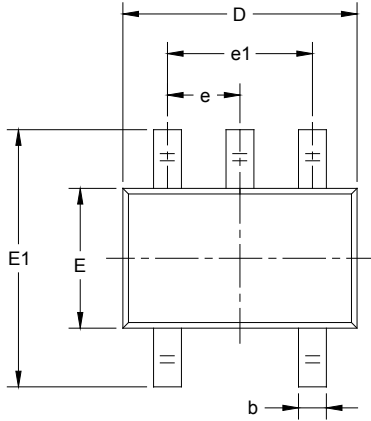

RECOMMENDED LAND PATTERN (Unit: mm)

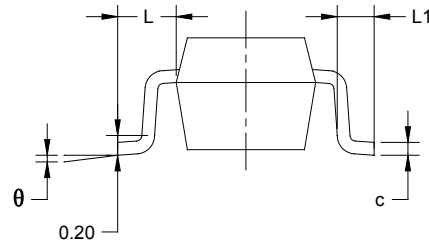
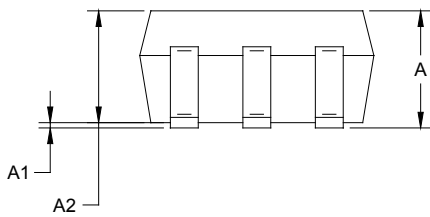

Symbol	Dimensions In Millimeters		Dimensions In Inches	
	MIN	MAX	MIN	MAX
A	0.900	1.100	0.035	0.043
A1	0.000	0.100	0.000	0.004
A2	0.900	1.000	0.035	0.039
b	0.150	0.350	0.006	0.014
c	0.080	0.150	0.003	0.006
D	2.000	2.200	0.079	0.087
E	1.150	1.350	0.045	0.053
E1	2.150	2.450	0.085	0.096
e	0.65 TYP		0.026 TYP	
e1	1.300 BSC		0.051 BSC	
L	0.525 REF		0.021 REF	
L1	0.260	0.460	0.010	0.018
θ	0°	8°	0°	8°

PACKAGE INFORMATION

TAPE AND REEL INFORMATION

REEL DIMENSIONS



TAPE DIMENSIONS



NOTE: The picture is only for reference. Please make the object as the standard.

KEY PARAMETER LIST OF TAPE AND REEL

Package Type	Reel Diameter	Reel Width W1 (mm)	A0 (mm)	B0 (mm)	K0 (mm)	P0 (mm)	P1 (mm)	P2 (mm)	W (mm)	Pin1 Quadrant
SOT-23-5	7"	9.5	3.20	3.20	1.40	4.0	4.0	2.0	8.0	Q3
SC70-5	7"	9.5	2.25	2.55	1.20	4.0	4.0	2.0	8.0	Q3

D00001

PACKAGE INFORMATION

CARTON BOX DIMENSIONS



NOTE: The picture is only for reference. Please make the object as the standard.

KEY PARAMETER LIST OF CARTON BOX

Reel Type	Length (mm)	Width (mm)	Height (mm)	Pizza/Carton
7" (Option)	368	227	224	8
7"	442	410	224	18

DD0002