

GENERAL DESCRIPTION

The SGM41100A is designed for primary protection of Li-Ion/polymer rechargeable cells. The product integrates all the protections required for safe operation of polymer rechargeable cells. The device is packaged in a tiny and thin package. Its small solution size leaves more space for fitting the battery cell into a given cavity for small size wearable devices.

The SGM41100A integrates all the protections and the required low on-resistance disconnect switch on one die. The protection features include charge and discharge protection, detection and protection of a cell in charge over-voltage, charge over-current, discharge under-voltage and discharge over-current. The product also disconnects the battery pack in the case of deep discharge.

The SGM41100A operates in -40°C to +85°C temperature range, and is in a thin and low profile UTDFN-1.5×2-6L package. This package with a nominal height of 0.5mm is convenient for small cell packing designs.

FEATURES

- Ultra-Compact Protection Solution
- Pass Resistance: 42mΩ (TYP)
- Operation Current: 0.9μA (TYP)
- Factory Programmable OVP Threshold Options
4.20V to 4.55V with 0.05V per Step
- Charge/Discharge Over-Current Protection
3 Thresholds Combination Options
- Battery Under-Voltage Protection
2.4V/2.6V/2.8V/3.0V Options
- 50nA Deep Discharge Shutdown
- Exhausted Battery Charging from 0.2V
- Input Surge Clamping
- Input Over-Voltage Safe
- Load Short-Circuit Safe
- Reverse Polarity Battery Safe
- Input Reversed-Attaching Safe
- Battery Pack Paralleling Safe
- Locked-Off for Delivery/Assembly
- Available in a Green UTDFN-1.5×2-6L Package

APPLICATIONS

- IoT Gadgets
- Wearable Devices
- Battery Packs

TYPICAL APPLICATION

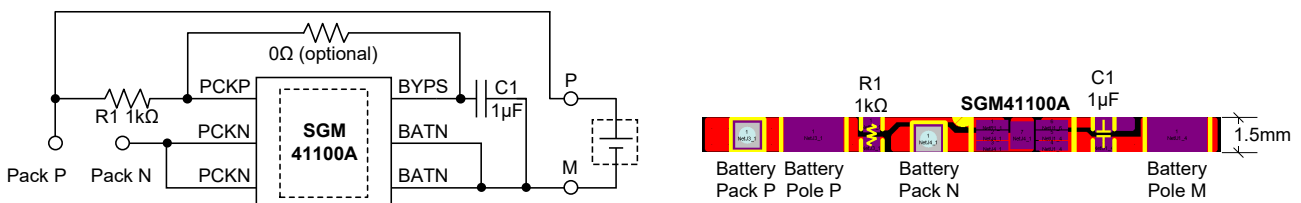

NOTE: The short-circuit of both ends (P and M) of the battery should be avoided during the battery assembly process.

Figure 1. Typical Application Circuit and Demonstration Board Outline

PACKAGE/ORDERING INFORMATION

MODEL	PACKAGE DESCRIPTION	SPECIFIED TEMPERATURE RANGE	ORDERING NUMBER	PACKAGE MARKING	PACKING OPTION
SGM41100A-420M03	UTDFN-1.5×2-6L	-40°C to +85°C	SGM41100A-420M03YUDT6G/TR	CM8 XXX	Tape and Reel, 3000
SGM41100A-420M05	UTDFN-1.5×2-6L	-40°C to +85°C	SGM41100A-420M05YUDT6G/TR	CMC XXX	Tape and Reel, 3000
SGM41100A-420M09	UTDFN-1.5×2-6L	-40°C to +85°C	SGM41100A-420M09YUDT6G/TR	CN7 XXX	Tape and Reel, 3000
SGM41100A-420N03	UTDFN-1.5×2-6L	-40°C to +85°C	SGM41100A-420N03YUDT6G/TR	CNA XXX	Tape and Reel, 3000
SGM41100A-420N05	UTDFN-1.5×2-6L	-40°C to +85°C	SGM41100A-420N05YUDT6G/TR	CNB XXX	Tape and Reel, 3000
SGM41100A-420N09	UTDFN-1.5×2-6L	-40°C to +85°C	SGM41100A-420N09YUDT6G/TR	CNC XXX	Tape and Reel, 3000
SGM41100A-420O03	UTDFN-1.5×2-6L	-40°C to +85°C	SGM41100A-420O03YUDT6G/TR	CNE XXX	Tape and Reel, 3000
SGM41100A-420O05	UTDFN-1.5×2-6L	-40°C to +85°C	SGM41100A-420O05YUDT6G/TR	CNF XXX	Tape and Reel, 3000
SGM41100A-420O09	UTDFN-1.5×2-6L	-40°C to +85°C	SGM41100A-420O09YUDT6G/TR	CO0 XXX	Tape and Reel, 3000
SGM41100A-420P03	UTDFN-1.5×2-6L	-40°C to +85°C	SGM41100A-420P03YUDT6G/TR	CO2 XXX	Tape and Reel, 3000
SGM41100A-420P05	UTDFN-1.5×2-6L	-40°C to +85°C	SGM41100A-420P05YUDT6G/TR	CO3 XXX	Tape and Reel, 3000
SGM41100A-420P09	UTDFN-1.5×2-6L	-40°C to +85°C	SGM41100A-420P09YUDT6G/TR	CO4 XXX	Tape and Reel, 3000
SGM41100A-425M03	UTDFN-1.5×2-6L	-40°C to +85°C	SGM41100A-425M03YUDT6G/TR	CO6 XXX	Tape and Reel, 3000
SGM41100A-425M05	UTDFN-1.5×2-6L	-40°C to +85°C	SGM41100A-425M05YUDT6G/TR	CO7 XXX	Tape and Reel, 3000
SGM41100A-425M09	UTDFN-1.5×2-6L	-40°C to +85°C	SGM41100A-425M09YUDT6G/TR	CO8 XXX	Tape and Reel, 3000
SGM41100A-425N03	UTDFN-1.5×2-6L	-40°C to +85°C	SGM41100A-425N03YUDT6G/TR	COA XXX	Tape and Reel, 3000
SGM41100A-425N05	UTDFN-1.5×2-6L	-40°C to +85°C	SGM41100A-425N05YUDT6G/TR	COB XXX	Tape and Reel, 3000
SGM41100A-425N09	UTDFN-1.5×2-6L	-40°C to +85°C	SGM41100A-425N09YUDT6G/TR	COC XXX	Tape and Reel, 3000
SGM41100A-425O03	UTDFN-1.5×2-6L	-40°C to +85°C	SGM41100A-425O03YUDT6G/TR	COE XXX	Tape and Reel, 3000
SGM41100A-425O05	UTDFN-1.5×2-6L	-40°C to +85°C	SGM41100A-425O05YUDT6G/TR	COF XXX	Tape and Reel, 3000
SGM41100A-425O09	UTDFN-1.5×2-6L	-40°C to +85°C	SGM41100A-425O09YUDT6G/TR	CP0 XXX	Tape and Reel, 3000
SGM41100A-425P03	UTDFN-1.5×2-6L	-40°C to +85°C	SGM41100A-425P03YUDT6G/TR	CP2 XXX	Tape and Reel, 3000
SGM41100A-425P05	UTDFN-1.5×2-6L	-40°C to +85°C	SGM41100A-425P05YUDT6G/TR	CP3 XXX	Tape and Reel, 3000
SGM41100A-425P09	UTDFN-1.5×2-6L	-40°C to +85°C	SGM41100A-425P09YUDT6G/TR	CP4 XXX	Tape and Reel, 3000
SGM41100A-430M03	UTDFN-1.5×2-6L	-40°C to +85°C	SGM41100A-430M03YUDT6G/TR	CP6 XXX	Tape and Reel, 3000
SGM41100A-430M05	UTDFN-1.5×2-6L	-40°C to +85°C	SGM41100A-430M05YUDT6G/TR	CP7 XXX	Tape and Reel, 3000

SGM41100A

True Monolithic Li-Ion/Polymer Battery Protector in Tiny Thin Package

MODEL	PACKAGE DESCRIPTION	SPECIFIED TEMPERATURE RANGE	ORDERING NUMBER	PACKAGE MARKING	PACKING OPTION
SGM41100A-430M09	UTDFN-1.5×2-6L	-40°C to +85°C	SGM41100A-430M09YUDT6G/TR	CP8 XXX	Tape and Reel, 3000
SGM41100A-430N03	UTDFN-1.5×2-6L	-40°C to +85°C	SGM41100A-430N03YUDT6G/TR	CPA XXX	Tape and Reel, 3000
SGM41100A-430N05	UTDFN-1.5×2-6L	-40°C to +85°C	SGM41100A-430N05YUDT6G/TR	CPB XXX	Tape and Reel, 3000
SGM41100A-430N09	UTDFN-1.5×2-6L	-40°C to +85°C	SGM41100A-430N09YUDT6G/TR	CPC XXX	Tape and Reel, 3000
SGM41100A-430O03	UTDFN-1.5×2-6L	-40°C to +85°C	SGM41100A-430O03YUDT6G/TR	CPE XXX	Tape and Reel, 3000
SGM41100A-430O05	UTDFN-1.5×2-6L	-40°C to +85°C	SGM41100A-430O05YUDT6G/TR	CPF XXX	Tape and Reel, 3000
SGM41100A-430O09	UTDFN-1.5×2-6L	-40°C to +85°C	SGM41100A-430O09YUDT6G/TR	CQ0 XXX	Tape and Reel, 3000
SGM41100A-430P03	UTDFN-1.5×2-6L	-40°C to +85°C	SGM41100A-430P03YUDT6G/TR	CQ2 XXX	Tape and Reel, 3000
SGM41100A-430P05	UTDFN-1.5×2-6L	-40°C to +85°C	SGM41100A-430P05YUDT6G/TR	CQ3 XXX	Tape and Reel, 3000
SGM41100A-430P09	UTDFN-1.5×2-6L	-40°C to +85°C	SGM41100A-430P09YUDT6G/TR	CQ4 XXX	Tape and Reel, 3000
SGM41100A-435M03	UTDFN-1.5×2-6L	-40°C to +85°C	SGM41100A-435M03YUDT6G/TR	CQ6 XXX	Tape and Reel, 3000
SGM41100A-435M05	UTDFN-1.5×2-6L	-40°C to +85°C	SGM41100A-435M05YUDT6G/TR	CQ7 XXX	Tape and Reel, 3000
SGM41100A-435M09	UTDFN-1.5×2-6L	-40°C to +85°C	SGM41100A-435M09YUDT6G/TR	CQ8 XXX	Tape and Reel, 3000
SGM41100A-435N03	UTDFN-1.5×2-6L	-40°C to +85°C	SGM41100A-435N03YUDT6G/TR	CQA XXX	Tape and Reel, 3000
SGM41100A-435N05	UTDFN-1.5×2-6L	-40°C to +85°C	SGM41100A-435N05YUDT6G/TR	CQB XXX	Tape and Reel, 3000
SGM41100A-435N09	UTDFN-1.5×2-6L	-40°C to +85°C	SGM41100A-435N09YUDT6G/TR	CQC XXX	Tape and Reel, 3000
SGM41100A-435O03	UTDFN-1.5×2-6L	-40°C to +85°C	SGM41100A-435O03YUDT6G/TR	CQE XXX	Tape and Reel, 3000
SGM41100A-435O05	UTDFN-1.5×2-6L	-40°C to +85°C	SGM41100A-435O05YUDT6G/TR	CQF XXX	Tape and Reel, 3000
SGM41100A-435O09	UTDFN-1.5×2-6L	-40°C to +85°C	SGM41100A-435O09YUDT6G/TR	CR0 XXX	Tape and Reel, 3000
SGM41100A-435P03	UTDFN-1.5×2-6L	-40°C to +85°C	SGM41100A-435P03YUDT6G/TR	CR2 XXX	Tape and Reel, 3000
SGM41100A-435P05	UTDFN-1.5×2-6L	-40°C to +85°C	SGM41100A-435P05YUDT6G/TR	CR3 XXX	Tape and Reel, 3000
SGM41100A-435P09	UTDFN-1.5×2-6L	-40°C to +85°C	SGM41100A-435P09YUDT6G/TR	CR4 XXX	Tape and Reel, 3000
SGM41100A-440M03	UTDFN-1.5×2-6L	-40°C to +85°C	SGM41100A-440M03YUDT6G/TR	CR6 XXX	Tape and Reel, 3000
SGM41100A-440M05	UTDFN-1.5×2-6L	-40°C to +85°C	SGM41100A-440M05YUDT6G/TR	CR7 XXX	Tape and Reel, 3000
SGM41100A-440M09	UTDFN-1.5×2-6L	-40°C to +85°C	SGM41100A-440M09YUDT6G/TR	CR8 XXX	Tape and Reel, 3000
SGM41100A-440N03	UTDFN-1.5×2-6L	-40°C to +85°C	SGM41100A-440N03YUDT6G/TR	CRA XXX	Tape and Reel, 3000
SGM41100A-440N05	UTDFN-1.5×2-6L	-40°C to +85°C	SGM41100A-440N05YUDT6G/TR	CRB XXX	Tape and Reel, 3000

SGM41100A

True Monolithic Li-Ion/Polymer Battery Protector in Tiny Thin Package

MODEL	PACKAGE DESCRIPTION	SPECIFIED TEMPERATURE RANGE	ORDERING NUMBER	PACKAGE MARKING	PACKING OPTION
SGM41100A-440N09	UTDFN-1.5×2-6L	-40°C to +85°C	SGM41100A-440N09YUDT6G/TR	CRC XXX	Tape and Reel, 3000
SGM41100A-440O03	UTDFN-1.5×2-6L	-40°C to +85°C	SGM41100A-440O03YUDT6G/TR	CRE XXX	Tape and Reel, 3000
SGM41100A-440O05	UTDFN-1.5×2-6L	-40°C to +85°C	SGM41100A-440O05YUDT6G/TR	CRF XXX	Tape and Reel, 3000
SGM41100A-440O09	UTDFN-1.5×2-6L	-40°C to +85°C	SGM41100A-440O09YUDT6G/TR	CS0 XXX	Tape and Reel, 3000
SGM41100A-440P03	UTDFN-1.5×2-6L	-40°C to +85°C	SGM41100A-440P03YUDT6G/TR	CS2 XXX	Tape and Reel, 3000
SGM41100A-440P05	UTDFN-1.5×2-6L	-40°C to +85°C	SGM41100A-440P05YUDT6G/TR	CS3 XXX	Tape and Reel, 3000
SGM41100A-440P09	UTDFN-1.5×2-6L	-40°C to +85°C	SGM41100A-440P09YUDT6G/TR	CS4 XXX	Tape and Reel, 3000
SGM41100A-445M03	UTDFN-1.5×2-6L	-40°C to +85°C	SGM41100A-445M03YUDT6G/TR	CS6 XXX	Tape and Reel, 3000
SGM41100A-445M05	UTDFN-1.5×2-6L	-40°C to +85°C	SGM41100A-445M05YUDT6G/TR	CS7 XXX	Tape and Reel, 3000
SGM41100A-445M09	UTDFN-1.5×2-6L	-40°C to +85°C	SGM41100A-445M09YUDT6G/TR	CS8 XXX	Tape and Reel, 3000
SGM41100A-445N03	UTDFN-1.5×2-6L	-40°C to +85°C	SGM41100A-445N03YUDT6G/TR	CSA XXX	Tape and Reel, 3000
SGM41100A-445N05	UTDFN-1.5×2-6L	-40°C to +85°C	SGM41100A-445N05YUDT6G/TR	CLB XXX	Tape and Reel, 3000
SGM41100A-445N09	UTDFN-1.5×2-6L	-40°C to +85°C	SGM41100A-445N09YUDT6G/TR	CSB XXX	Tape and Reel, 3000
SGM41100A-445O03	UTDFN-1.5×2-6L	-40°C to +85°C	SGM41100A-445O03YUDT6G/TR	CSD XXX	Tape and Reel, 3000
SGM41100A-445O05	UTDFN-1.5×2-6L	-40°C to +85°C	SGM41100A-445O05YUDT6G/TR	CSE XXX	Tape and Reel, 3000
SGM41100A-445O09	UTDFN-1.5×2-6L	-40°C to +85°C	SGM41100A-445O09YUDT6G/TR	CSF XXX	Tape and Reel, 3000
SGM41100A-445P03	UTDFN-1.5×2-6L	-40°C to +85°C	SGM41100A-445P03YUDT6G/TR	CT1 XXX	Tape and Reel, 3000
SGM41100A-445P05	UTDFN-1.5×2-6L	-40°C to +85°C	SGM41100A-445P05YUDT6G/TR	CT2 XXX	Tape and Reel, 3000
SGM41100A-445P09	UTDFN-1.5×2-6L	-40°C to +85°C	SGM41100A-445P09YUDT6G/TR	CM6 XXX	Tape and Reel, 3000
SGM41100A-450M03	UTDFN-1.5×2-6L	-40°C to +85°C	SGM41100A-450M03YUDT6G/TR	CT4 XXX	Tape and Reel, 3000
SGM41100A-450M05	UTDFN-1.5×2-6L	-40°C to +85°C	SGM41100A-450M05YUDT6G/TR	CT5 XXX	Tape and Reel, 3000
SGM41100A-450M09	UTDFN-1.5×2-6L	-40°C to +85°C	SGM41100A-450M09YUDT6G/TR	CT6 XXX	Tape and Reel, 3000
SGM41100A-450N03	UTDFN-1.5×2-6L	-40°C to +85°C	SGM41100A-450N03YUDT6G/TR	CT8 XXX	Tape and Reel, 3000
SGM41100A-450N05	UTDFN-1.5×2-6L	-40°C to +85°C	SGM41100A-450N05YUDT6G/TR	CT9 XXX	Tape and Reel, 3000
SGM41100A-450N09	UTDFN-1.5×2-6L	-40°C to +85°C	SGM41100A-450N09YUDT6G/TR	CTA XXX	Tape and Reel, 3000
SGM41100A-450O03	UTDFN-1.5×2-6L	-40°C to +85°C	SGM41100A-450O03YUDT6G/TR	CTC XXX	Tape and Reel, 3000
SGM41100A-450O05	UTDFN-1.5×2-6L	-40°C to +85°C	SGM41100A-450O05YUDT6G/TR	CTD XXX	Tape and Reel, 3000

SGM41100A

True Monolithic Li-Ion/Polymer Battery Protector in Tiny Thin Package

MODEL	PACKAGE DESCRIPTION	SPECIFIED TEMPERATURE RANGE	ORDERING NUMBER	PACKAGE MARKING	PACKING OPTION
SGM41100A-450O09	UTDFN-1.5×2-6L	-40°C to +85°C	SGM41100A-450O09YUDT6G/TR	CTE XXX	Tape and Reel, 3000
SGM41100A-450P03	UTDFN-1.5×2-6L	-40°C to +85°C	SGM41100A-450P03YUDT6G/TR	CU0 XXX	Tape and Reel, 3000
SGM41100A-450P05	UTDFN-1.5×2-6L	-40°C to +85°C	SGM41100A-450P05YUDT6G/TR	CU1 XXX	Tape and Reel, 3000
SGM41100A-450P09	UTDFN-1.5×2-6L	-40°C to +85°C	SGM41100A-450P09YUDT6G/TR	CU2 XXX	Tape and Reel, 3000
SGM41100A-455M03	UTDFN-1.5×2-6L	-40°C to +85°C	SGM41100A-455M03YUDT6G/TR	CU4 XXX	Tape and Reel, 3000
SGM41100A-455M05	UTDFN-1.5×2-6L	-40°C to +85°C	SGM41100A-455M05YUDT6G/TR	CU5 XXX	Tape and Reel, 3000
SGM41100A-455M09	UTDFN-1.5×2-6L	-40°C to +85°C	SGM41100A-455M09YUDT6G/TR	CU6 XXX	Tape and Reel, 3000
SGM41100A-455N03	UTDFN-1.5×2-6L	-40°C to +85°C	SGM41100A-455N03YUDT6G/TR	CU8 XXX	Tape and Reel, 3000
SGM41100A-455N05	UTDFN-1.5×2-6L	-40°C to +85°C	SGM41100A-455N05YUDT6G/TR	CU9 XXX	Tape and Reel, 3000
SGM41100A-455N09	UTDFN-1.5×2-6L	-40°C to +85°C	SGM41100A-455N09YUDT6G/TR	CUA XXX	Tape and Reel, 3000
SGM41100A-455O03	UTDFN-1.5×2-6L	-40°C to +85°C	SGM41100A-455O03YUDT6G/TR	CUC XXX	Tape and Reel, 3000
SGM41100A-455O05	UTDFN-1.5×2-6L	-40°C to +85°C	SGM41100A-455O05YUDT6G/TR	CUD XXX	Tape and Reel, 3000
SGM41100A-455O09	UTDFN-1.5×2-6L	-40°C to +85°C	SGM41100A-455O09YUDT6G/TR	CUE XXX	Tape and Reel, 3000
SGM41100A-455P03	UTDFN-1.5×2-6L	-40°C to +85°C	SGM41100A-455P03YUDT6G/TR	CV0 XXX	Tape and Reel, 3000
SGM41100A-455P05	UTDFN-1.5×2-6L	-40°C to +85°C	SGM41100A-455P05YUDT6G/TR	CV1 XXX	Tape and Reel, 3000
SGM41100A-455P09	UTDFN-1.5×2-6L	-40°C to +85°C	SGM41100A-455P09YUDT6G/TR	CV2 XXX	Tape and Reel, 3000

MARKING INFORMATION

NOTE: XXX = Date Code and Trace Code.

YYY — Serial Number

XXX

Trace Code

Date Code - Year

Green (RoHS & HSF): SG Micro Corp defines "Green" to mean Pb-Free (RoHS compatible) and free of halogen substances. If you have additional comments or questions, please contact your SGMICRO representative directly.

DEVICE DESCRIPTION

Model: SGM41100A-AAABCC

Over-Voltage Threshold Options								
Option Code "AAA"	420	425	430	435	440	445	450	455
Over-Voltage Threshold V_{OV} (V)	4.20	4.25	4.30	4.35	4.40	4.45	4.50	4.55
Under-Voltage Threshold Options								
Option Code "B"	M		N		O		P	
Under-Voltage Threshold V_{UV} (V)	2.4		2.6		2.8		3.0	
Current Threshold Combination Options								
Option Code "CC"	03		05		09			
Charge Over-Current I_{OC} (A)	0.180		0.340		0.700			
Discharge Over-Current I_{OD} (A)	0.260		0.480		0.900			
Short-Circuit Current (A)	4 × 0.260		4 × 0.480		3 × 0.900			

ABSOLUTE MAXIMUM RATINGS

PCKP to PCKN, 13V⁽¹⁾, 10mA Clamping⁽²⁾5s
 PCKP to PCKN-4.5V or +9V⁽³⁾, Continuous
 PCKP to BATN-4.5V⁽³⁾ or +5.5V
 PCKP to PCKN Short-Circuit⁽⁴⁾ Continuous
 PCKP to PCKN Attachment Inrush/Outrush⁽⁵⁾ +9V/-4.5V
 PCKP to BATN Attachment Inrush/Outrush⁽⁶⁾ ±4.5V
 Surge Current⁽⁷⁾ ±20A
 Junction Temperature +150°C
 Storage Temperature Range -65°C to +150°C
 Lead Temperature (Soldering, 10s) +260°C
 ESD Susceptibility
 HBM 3000V
 CDM 1000V

NOTES:

1. Evaluation at V_{BAT} = 4.5V.
2. The clamping may reach 10mA at an input voltage > 13V.
3. Test with a voltage regulated supply that has 2A current limit and increase the voltage progressively for less than 1V/ms slope rate. Apply a voltage to the device under test from 0V to given voltages.
4. The device is tested after being installed on the circuit board in Figure 1. Clip a 4.5V 5A power source onto the P and M to simulate a battery and short the Pack P and the Pack N with an 80mΩ wire.
5. The device is tested after being installed on the circuit board in Figure 1. Connect a 3.2V supply and 2A sinking resistor R_{SINK} as showed in Figure 2 to the P and M for inrush test. Clip a 4.5V 5A supply for outrush test.
6. The device is tested after being installed on the circuit board in Figure 1 with the circuit in Figure 3.
7. Parallel or connect in reverse polarity two battery packs of Figure 1. Limit the battery pack impedance to limit the surge current to 20A.

RECOMMENDED OPERATING CONDITIONS

Supply Voltage Range 0V to 6V
 Battery Voltage Range 0 to 4.5V
 Junction Temperature Range -40°C to +85°C

OVERSTRESS CAUTION

Stresses beyond those listed in Absolute Maximum Ratings may cause permanent damage to the device. Exposure to absolute maximum rating conditions for extended periods may affect reliability. Functional operation of the device at any conditions beyond those indicated in the Recommended Operating Conditions section is not implied.

ESD SENSITIVITY CAUTION

This integrated circuit can be damaged if ESD protections are not considered carefully. SGMICRO recommends that all integrated circuits be handled with appropriate precautions. Failure to observe proper handling and installation procedures can cause damage. ESD damage can range from subtle performance degradation to complete device failure. Precision integrated circuits may be more susceptible to damage because even small parametric changes could cause the device not to meet the published specifications.

DISCLAIMER

SG Micro Corp reserves the right to make any change in circuit design, or specifications without prior notice.

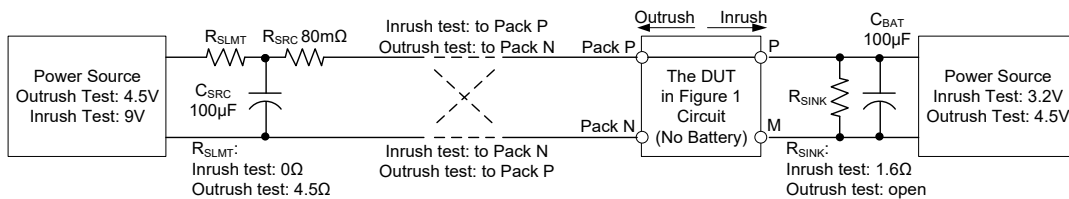

Figure 2. Test Set-Up for Pack P to Pack N Attachment Inrush/Outrush

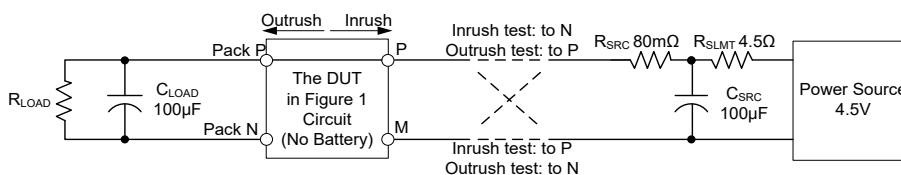
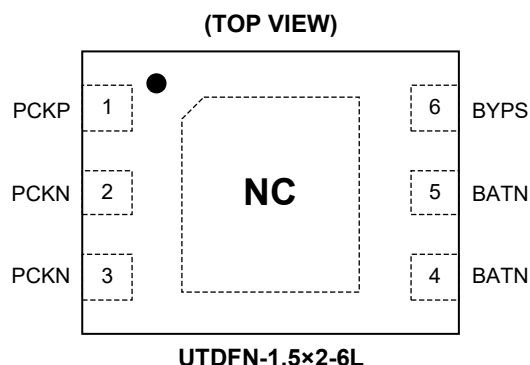

Figure 3. Test Set-Up for Pack P to BATN Attachment Inrush/Outrush

PIN CONFIGURATION



PIN DESCRIPTION

PIN	NAME	TYPE	FUNCTION
1	PCKP	P	Power Input and Output, the Battery Pack Positive Connection. The default state after battery attached is closed or locked-off, dependent on the external circuitry. Connect a 200nF capacitor between PCKN pin and BATN pin for setting the default state to closed. It is recommended to connect a 0Ω resistor between PCKP pin and BYPS pin for suppressing noise applied to the PCKP input.
2, 3	PCKN	P	Power Input and Output, the Battery Pack Cathode. Short this pin to BATN pin to release off the locked-open state, and make the output path closed.
4, 5	BATN	G	Ground of Internal Circuit. Connect to the battery cathode end.
6	BYPS	I/O	Bypass Pin and Disconnection Locked-Off Triggering Input. Place a 1μF capacitor between this pin and BATN pin. Shorting this pin to PCKN pin momentarily places the circuit into locked-open state.
Exposed Pad	NC	NC	Not Connected Internally. It is recommended to connect to PCKN pin or BATN pin for benefiting ESD shielding or recovering from the over-current protection. The over-all leakage condition on a specific PCB board may have different effects on the recovery process. With this process, the on-board verification is a necessary proof of better connection.

NOTE: I/O = Input or Output, G = Ground, P = Power for the Circuit, NC = Not Connected.

ELECTRICAL CHARACTERISTICS

(T_J = +25°C, I_{CHG} = I_{DIS} = 200mA, V_{BAT} = 3.7V, unless otherwise noted.)

PARAMETER	SYMBOL	CONDITIONS	MIN	TYP	MAX	UNITS				
Charge Over-Voltage Threshold	V _{OV}	SGM41100A-420_ _ _	T _J = +25°C	4.175	4.200	4.225	V			
			T _J = -20°C to +55°C	4.160		4.240				
			T _J = -40°C to +85°C	4.150		4.250				
		SGM41100A-425_ _ _	T _J = +25°C	4.225	4.250	4.275				
			T _J = -20°C to +55°C	4.210		4.290				
			T _J = -40°C to +85°C	4.200		4.300				
		SGM41100A-430_ _ _	T _J = +25°C	4.275	4.300	4.325				
			T _J = -20°C to +55°C	4.260		4.340				
			T _J = -40°C to +85°C	4.250		4.350				
		SGM41100A-435_ _ _	T _J = +25°C	4.325	4.350	4.375				
			T _J = -20°C to +55°C	4.310		4.390				
			T _J = -40°C to +85°C	4.300		4.400				
		SGM41100A-440_ _ _	T _J = +25°C	4.375	4.400	4.425				
			T _J = -20°C to +55°C	4.360		4.440				
			T _J = -40°C to +85°C	4.350		4.450				
		SGM41100A-445_ _ _	T _J = +25°C	4.425	4.450	4.475				
			T _J = -20°C to +55°C	4.410		4.490				
			T _J = -40°C to +85°C	4.400		4.500				
		SGM41100A-450_ _ _	T _J = +25°C	4.475	4.500	4.525				
			T _J = -20°C to +55°C	4.460		4.540				
			T _J = -40°C to +85°C	4.450		4.550				
		SGM41100A-455_ _ _	T _J = +25°C	4.525	4.550	4.575				
			T _J = -20°C to +55°C	4.510		4.590				
			T _J = -40°C to +85°C	4.500		4.600				
		OV Release Hysteresis	V _{OVHYS}	Charger voltage lower than battery voltage	T _J = -40°C to +85°C	100		145	190	mV
		Battery Under-Voltage Threshold	V _{UV}	SGM41100A- _ _ _ M _ _	T _J = +25°C	2.36		2.40	2.44	V
					T _J = -20°C to +55°C	2.35			2.45	
					T _J = -40°C to +85°C	2.34			2.46	
				SGM41100A- _ _ _ N _ _	T _J = +25°C	2.56		2.60	2.64	
					T _J = -20°C to +55°C	2.55			2.65	
					T _J = -40°C to +85°C	2.54			2.66	
				SGM41100A- _ _ _ O _ _	T _J = +25°C	2.76		2.80	2.84	
					T _J = -20°C to +55°C	2.75			2.85	
					T _J = -40°C to +85°C	2.74			2.86	
				SGM41100A- _ _ _ P _ _	T _J = +25°C	2.96		3.00	3.04	
					T _J = -20°C to +55°C	2.95			3.05	
T _J = -40°C to +85°C	2.94				3.06					
UV Release Hysteresis	V _{UVHYS}			When a charging supply is applied	T _J = -40°C to +85°C	70	100	130	mV	

ELECTRICAL CHARACTERISTICS (continued)

(T_J = +25°C, I_{CHG} = I_{DIS} = 200mA, V_{BAT} = 3.7V, unless otherwise noted.)

PARAMETER	SYMBOL	CONDITIONS	MIN	TYP	MAX	UNITS
Shutdown Voltage	V _{SHDN}	T _J = +25°C	1.4	1.6	1.8	V
		T _J = -40°C to +85°C	1.2		2.0	
Discharge Over-Current	I _{OD}	SGM41100A-____03	T _J = +25°C	0.26	0.33	A
			T _J = -40°C to +85°C		0.17	
		SGM41100A-____05	T _J = +25°C	0.48	0.57	
			T _J = -40°C to +85°C		0.36	
		SGM41100A-____09	T _J = +25°C	0.90	1.03	
			T _J = -40°C to +85°C		0.72	
Charge Over-Current	I _{OC}	SGM41100A-____03	T _J = +25°C	0.18	0.25	A
			T _J = -40°C to +85°C		0.10	
		SGM41100A-____05	T _J = +25°C	0.34	0.42	
			T _J = -40°C to +85°C		0.25	
		SGM41100A-____09	T _J = +25°C	0.70	0.82	
			T _J = -40°C to +85°C		0.56	
Pass Resistance	R _P	T _J = +25°C	38	42	46	mΩ
		T _J = -40°C to +85°C	27		57	
Operating Current	I _{OP}	T _J = +25°C		0.9	1.3	μA
		T _J = -40°C to +85°C			1.5	
Shutdown Current	I _{SHDN}	The stable current flowing into the device when it is in any of following shutdown conditions that the battery voltage is lower than V _{UV} (then V _{SHDN} if the battery voltage further drops), the device is set into latched-off	T _J = +25°C		0.05	μA
			T _J = -40°C to +85°C		0.3	
Over-Voltage Detection Delay ⁽¹⁾	t _{OVDP}	T _J = +25°C	923	1066	1209	ms
		T _J = -40°C to +85°C	537		1342	
Under-Voltage Detection Delay ⁽¹⁾	t _{UVDP}	T _J = +25°C	115	144	188	ms
		T _J = -40°C to +85°C	67		208	
Discharge Over-Current Detection Delay ⁽¹⁾	t _{ODD}	T _J = +25°C	57	80	113	ms
		T _J = -40°C to +85°C	33		125	
Discharge Over-Current Retry Time ⁽¹⁾	t _{RETRY}	T _J = +25°C	461	528	609	ms
		T _J = -40°C to +85°C	268		676	
Charge Over-Current Detection Delay ⁽¹⁾	t _{OCD}	T _J = +25°C	57	80	113	ms
		T _J = -40°C to +85°C	33		125	
Discharge Short-Circuit Detection Delay	t _{OCSD}	T _J = +25°C	0.196	0.3	0.5	ms
		T _J = -40°C to +85°C	0.14		0.7	
Discharge Short-Circuit Current	I _{SC}	SGM41100A-____09		3 × I _{OD}		
		Other Options		4 × I _{OD}		

NOTE:

1. The TYP value and MAX value are combination of the detection delay time and a possible polling period of about 32ms, while the MIN value represents the minimum detection delay with portion of a polling period added, as the pass path cutting action is synchronized to the internal polling.

TYPICAL PERFORMANCE CHARACTERISTICS

T_J = +25°C, I_{CHG} = I_{DIS} = 200mA, V_{BAT} = 3.7V, unless otherwise noted.

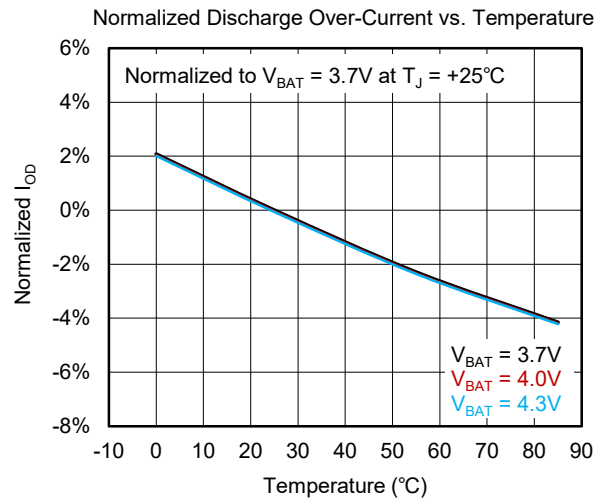
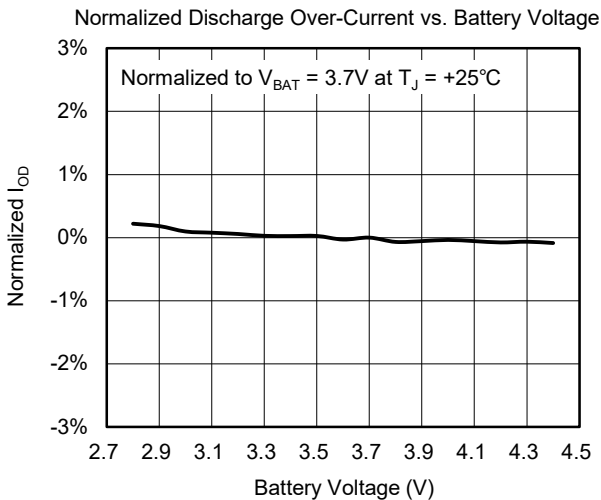
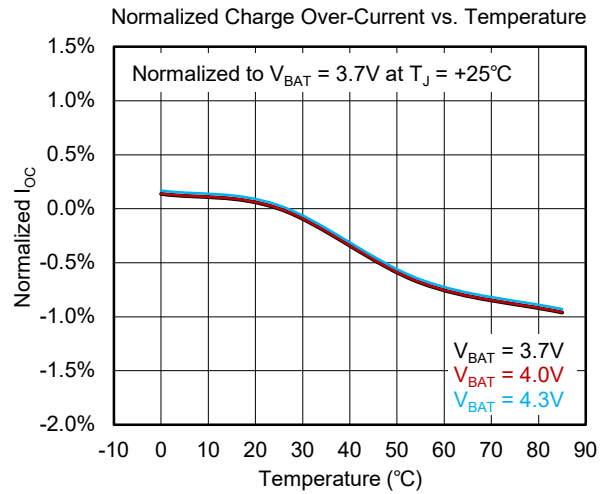
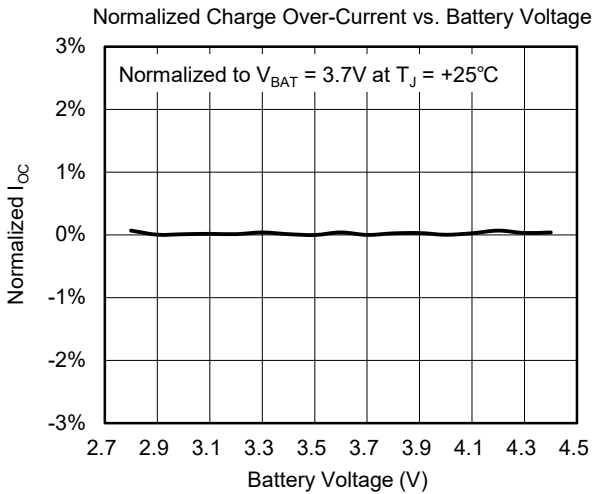
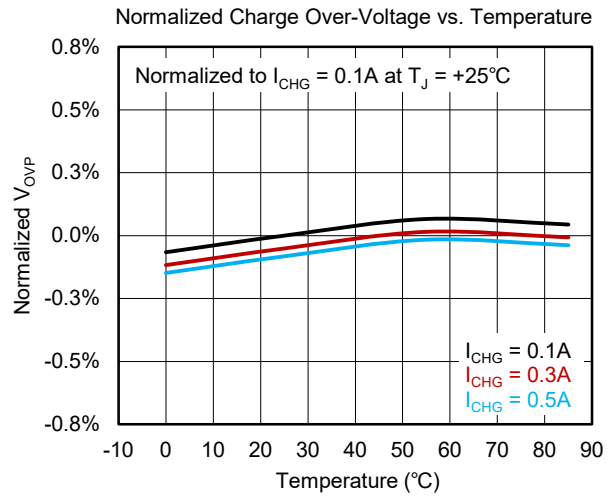
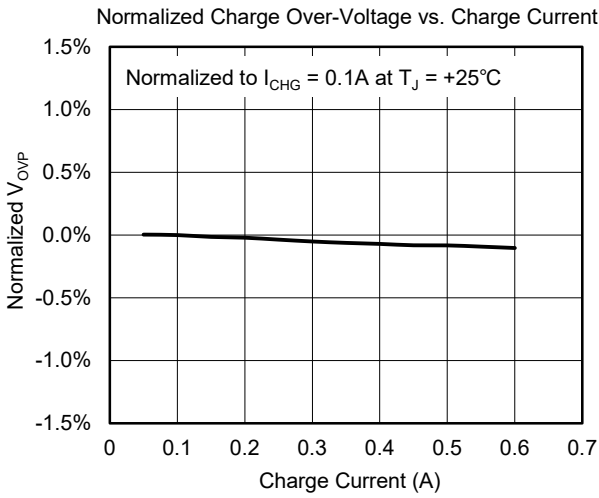

TYPICAL PERFORMANCE CHARACTERISTICS (continued)

$T_J = +25^\circ\text{C}$, $I_{\text{CHG}} = I_{\text{DIS}} = 200\text{mA}$, $V_{\text{BAT}} = 3.7\text{V}$, unless otherwise noted.

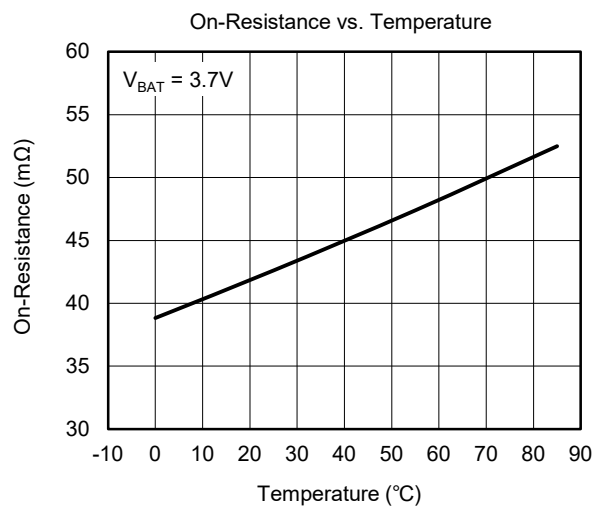
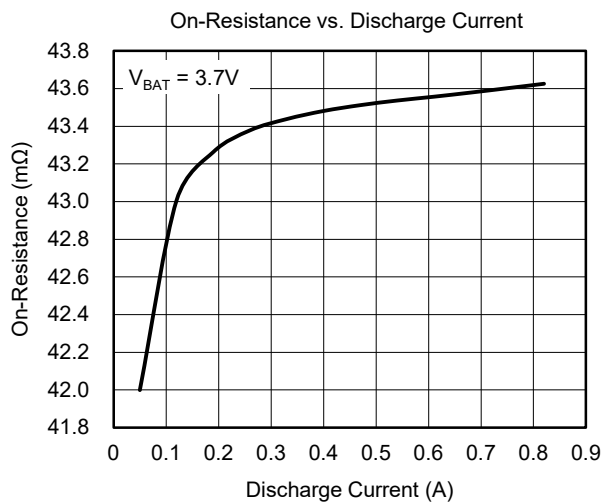
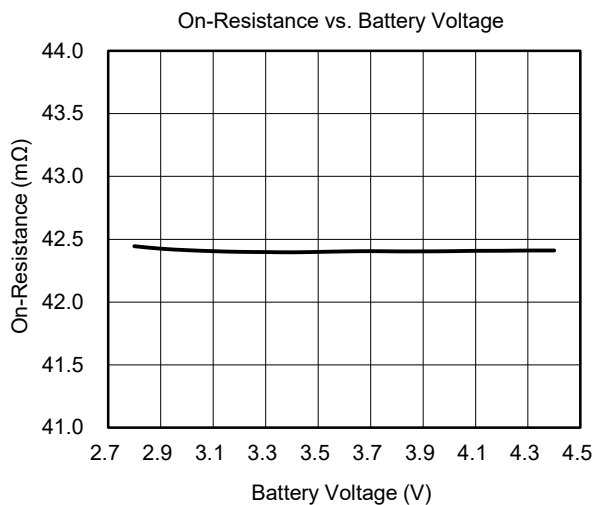

DETAILED DESCRIPTION

The SGM41100A monitors voltage and current applied on battery cell connected between PCKP and BATN, and opens the connection between battery and pack terminal with its internal switches when a fault condition is detected.

Voltage Related Protections

When battery voltage reaches over-voltage threshold (V_{OV}), the charge path is open-circuit. The path closes again when the charger voltage is lower than battery voltage and the battery voltage falls back about V_{OVHYS} below the over-voltage threshold (V_{OV}).

In order to protect the battery from discharge under-voltage status when battery voltage falls below V_{UV} for t_{UVPD} or V_{SHDN} instantly, the discharge path is open-circuit, the device enters into shutdown with only very low resistive leakage flowing into it, which helps to keep the battery from harmful exhausted condition as long as possible. The path closes again when a charging supply is applied and the battery voltage rises to about V_{UVHYS} above the V_{UV} threshold.

Charge an exhausted battery: While the battery is over-discharged the battery could be in the following states.

- a) Battery voltage below 0.2V: Both charge and discharge paths are open-circuit.
- b) Battery voltage in the range of 0.2V to V_{SHDN} : The battery is charged through the MOSFET body diode.
- c) Battery voltage in the range of V_{SHDN} to V_{UV} : The path switch is on for 144ms (t_{UVPD}) in every 130ms and off for 2ms when charge current flows through the body diode. During this period, the charger will see the terminal voltage steps up/down.
- d) Battery voltage above under-voltage threshold: In this condition, the chip enters normal operation and charge and discharge modes are allowed.

Current Related Protections

When discharge over-current condition occurs and keeps for discharge over-current detection delay (t_{ODD}), the discharge path opens. The path closes again after t_{RETRY} for retrying.

During a charging condition if a charge over-current is identified, the SGM41100A enters the locked-off state. This state can be reset by charger removal (pack removal).

Short-circuit protection: When discharge current exceeds 4 times or 3 times of the over-current threshold (4-times for _03/_05 options, 3-times for _09 option), discharge path disconnects instantly in t_{OCSD} , in order to protect the battery from potential over-current stress. After this disconnection, the SGM41100A stays in the locked-off non-conducting state until being reactivated, or leakage condition pulls the PCKN potential off the PCKP's towards to the BATN potential when the load is fully detached off.

Burst load outrush: In many systems, overload conditions will occur momentarily. The device allows for this short duration discharge condition by allowing the discharge path to remain closed even after a discharge over-current is detected for duration of discharge over-current detection delay.

When a charge over-current condition is identified, and after charge over-current detection deglitch, the charge path is cut off. The device restores to the conducting state when the PCKP to PCKN voltage drops about 3mV lower than the battery voltage.

Parallel battery packs: When paralleling two battery packs utilizing SGM41100As, a momentary current surge may cause charge over-current protection in the pack with the lower voltage. The higher voltage pack can enter a discharge over-current protection. The charge over-current or discharge over-current protection resets only after the higher voltage battery pack discharges to a voltage slightly lower than the lower voltage pack. After this discharge both packs will conduct.

It is highly recommended that the packs should be placed into a locked-open non-conducting state first (by connecting BYPS to PCKN momentarily) before being paralleled to avoid current overstress. When a charge supply is applied to the paralleled packs, the locked-open state will release.

DETAILED DESCRIPTION (continued)

Battery delivery state: It is recommended to deliver a battery pack in a locked-off non-conducting state to avoid unintentional shorting during production handling or transportation. The circuit of Figure 1 places the SGM41100A into a locked-off state after battery attachment by momentarily shorting BYPS and PCKN.

Connecting a 220nF capacitor clapping between BATN and PCKN may place the device into conducting state, which might couple enough charge for making enough voltage difference between PCKN and PCKP for over about 1.3V. The voltage difference is the dividing result of the clapping capacitance and the load resistance and capacitance. The 220nF capacitance is recommended for no load condition.

Pack activation: In order to release the pack from locked-off state and to place it into a conducting state, apply a charging input, or connect PCKN to BATN momentarily when there is no high load capacitance.

Caution: The battery short or load side terminal short outside the protection circuit's loop during battery attaching may cause excessive high surge current and excessive high current-breaking voltage surge, which may cause damage or degrade the life duration of battery and protection circuit. It is recorded that the accidental anode to ground plane shorting causes heavy surge, which can actually be avoided by leaving enough clearance around the anode pad on PCB or soldering/attaching the anode firstly in assembly (as the short between cathode to ground will not cause excessive surge).

Surge, ESD and Reversed Attachment

The SGM41100A absorbs voltage surge applied between PCKP and PCKN, by passing the surge current through its switch and the battery. Surge may occur when attaching the pack or battery cell.

The SGM41100A survives either if a cell is placed in reverse or a charge input is attached in reverse, but not both at the same time. Any of these reverse attachments, short circuits, inrush surges and outrush will cause overstress. Do not test those cases in normal production inspection, as this kind of test itself may cause performance degradation or even damage the device.

Caution about ESD damage to the battery: The battery pack might be the biggest element in equipment and induce much during an ESD event. Careful design of guided discharge path is desired for the equipment case sealing air-gap discharge over the battery and those connect to the battery closely.

Caution on electrochemical corrosion: As a battery can apply potential over the electrodes continuously and cause electrochemical corrosion, the corrosion product may spread in the hollow beneath a surface mount device and cause leakage. Moisture-proof coating is recommended, especially when using compact devices.

Cautions for Evaluation Test

Some types of electronic load simulators may have excessive inrush current, and some BPM testers may have voltage transition surges, which may trigger the protection of the SGM41100A. Careful attention is required for doing such evaluations with these kinds of equipment. External voltage and current limits within the conditions specified in the Absolute Maximum Ratings section of this datasheet are required.

Select Protection Parameters

Battery models from different vendors may be customized for different applications. Consult the battery vendor for protection limits for specific battery model.

Parameters for the protection circuit and of the charger circuit affecting same variables should be set for proper charge or discharge protection sequence. For example, the over-voltage threshold of the battery should be 50mV ~ 100mV higher than constant voltage threshold of the charger.

Cautions on parameter misalignment: If the V_{OV} is lower than the full charge voltage of the battery charger, the protection circuit cuts off the battery charge path before the battery is fully charged, and turns into the non-conductive locked-off state; if the I_{OC} is lower than the charge current, the protection circuit also turns itself into the locked-off state. In either V_{OV} or I_{OC} , the charger input should be removed and then reapplied for activating the protection circuit from the locked-off state to the conducting state. If the charger is not removed after a V_{OV} or I_{OV} event, the battery will not be charged even if the battery voltage is depleted.

REVISION HISTORY

NOTE: Page numbers for previous revisions may differ from page numbers in the current version.

AUGUST 2021– REV.A.1 to REV.A.2	Page
Updated Electrical Characteristics section	10

DECEMBER 2020– REV.A to REV.A.1	Page
Updated Electrical Characteristics section	10
Updated Detailed Description section	13, 14

Changes from Original (OCTOBER 2020) to REV.A	Page
Changed from product preview to production data.....	All

PACKAGE OUTLINE DIMENSIONS

UTDFN-1.5×2-6L

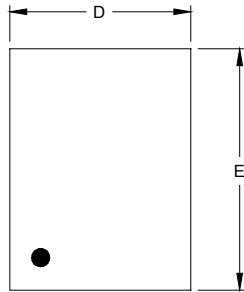

TOP VIEW

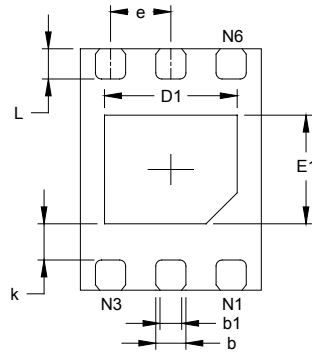

BOTTOM VIEW

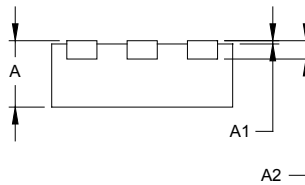

SIDE VIEW

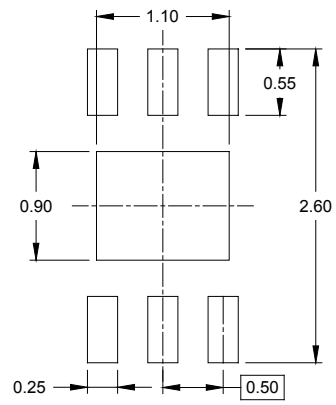

RECOMMENDED LAND PATTERN (Unit: mm)

Symbol	Dimensions In Millimeters		Dimensions In Inches	
	MIN	MAX	MIN	MAX
A	0.500	0.600	0.020	0.024
A1	0.000	0.050	0.000	0.002
A2	0.152 REF		0.006 REF	
D	1.400	1.600	0.055	0.063
D1	1.000	1.200	0.039	0.047
E	1.900	2.100	0.075	0.083
E1	0.800	1.000	0.031	0.039
k	0.300 REF		0.012 REF	
b	0.200	0.300	0.008	0.012
b1	0.180 REF		0.007 REF	
e	0.500 BSC		0.020 BSC	
L	0.200	0.300	0.008	0.012

PACKAGE INFORMATION

TAPE AND REEL INFORMATION

REEL DIMENSIONS



TAPE DIMENSIONS



NOTE: The picture is only for reference. Please make the object as the standard.

KEY PARAMETER LIST OF TAPE AND REEL

Package Type	Reel Diameter	Reel Width W1 (mm)	A0 (mm)	B0 (mm)	K0 (mm)	P0 (mm)	P1 (mm)	P2 (mm)	W (mm)	Pin1 Quadrant
UTDFN-1.5×2-6L	7"	9.5	1.70	2.30	0.75	4.0	4.0	2.0	8.0	Q2

000001

PACKAGE INFORMATION

CARTON BOX DIMENSIONS



NOTE: The picture is only for reference. Please make the object as the standard.

KEY PARAMETER LIST OF CARTON BOX

Reel Type	Length (mm)	Width (mm)	Height (mm)	Pizza/Carton
7" (Option)	368	227	224	8
7"	442	410	224	18

DD0002