

GENERAL DESCRIPTION

The SGM2581 is a single channel power distribution switch. The switch operates from a wide range of 2.5V to 5.5V supply voltage, and is controlled by the EN pin. It can be used in USB power distribution applications.

A 100mΩ low R_{ON} N-MOSFET is integrated. The small size and quiescent current make the device very suitable for space limited, battery-powered applications.

A number of protection features are provided in the device including soft-start, current limit and thermal shutdown. Thermal shutdown shuts off the output MOSFET and asserts the nFAULT output if the die temperature exceeds +150°C, and the output MOSFET remains off until the die temperature drops to +130°C. The nFAULT pin asserts low during fault conditions after a 13ms blanking time to prevent false reporting.

SGM2581 is available in a Green SOT-23-5 package. It is rated over the -40°C to +85°C temperature range.

APPLICATIONS

Digital TV

Set-Top Box

Motherboard USB Power Switch

USB Device Power Switch

FEATURES

- **Input Voltage Range: 2.5V to 5.5V**
- **On-Resistance: 100mΩ (TYP)**
- **Three Current Limit Levels**
 - SGM2581A/B/G: 1100 ± 110mA
 - SGM2581C/D/I: 2100 ± 220mA
 - SGM2581E/F/K: 2600 ± 310mA
- **Quiescent Current: 23μA (TYP)**
- **Shutdown Current: 0.1μA (TYP)**
- **Full Set of Protections**
 - ◆ **Soft-Start**
 - ◆ **Under-Voltage Lockout for VIN**
 - ◆ **No Reversed Leakage Current**
 - ◆ **Thermal Shutdown**
- **Quick Output Discharge: SGM2581A/B/C/D/E/F**
- **EN Pin Pull-Down Resistor: 500kΩ (SGM2581G/I/K)**
- **Evaluated to IEC 60950-1, Ed 2, Am1, Annex CC, Test Program 1 with CB Report (SGM2581A/C/E)**
- **Available in a Green SOT-23-5 Package**

PACKAGE/ORDERING INFORMATION

MODEL	PACKAGE DESCRIPTION	SPECIFIED TEMPERATURE RANGE	ORDERING NUMBER	PACKAGE MARKING	PACKING OPTION
SGM2581A (Active High)	SOT-23-5	-40°C to +85°C	SGM2581AYN5G/TR	ST5XX	Tape and Reel, 3000
SGM2581B (Active Low)	SOT-23-5	-40°C to +85°C	SGM2581BYN5G/TR	STDXX	Tape and Reel, 3000
SGM2581C (Active High)	SOT-23-5	-40°C to +85°C	SGM2581CYN5G/TR	SU4XX	Tape and Reel, 3000
SGM2581D (Active Low)	SOT-23-5	-40°C to +85°C	SGM2581DYN5G/TR	SU5XX	Tape and Reel, 3000
SGM2581E (Active High)	SOT-23-5	-40°C to +85°C	SGM2581EYN5G/TR	SU6XX	Tape and Reel, 3000
SGM2581F (Active Low)	SOT-23-5	-40°C to +85°C	SGM2581FYN5G/TR	SU7XX	Tape and Reel, 3000
SGM2581G (Active High)	SOT-23-5	-40°C to +85°C	SGM2581GYN5G/TR	G57XX	Tape and Reel, 3000
SGM2581I (Active High)	SOT-23-5	-40°C to +85°C	SGM2581IYN5G/TR	G58XX	Tape and Reel, 3000
SGM2581K (Active High)	SOT-23-5	-40°C to +85°C	SGM2581KYN5G/TR	G59XX	Tape and Reel, 3000

MARKING INFORMATION

NOTE: XX = Date Code.

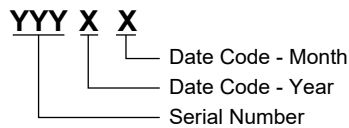

Green (RoHS & HSF): SG Micro Corp defines "Green" to mean Pb-Free (RoHS compatible) and free of halogen substances. If you have additional comments or questions, please contact your SGMICRO representative directly.

ABSOLUTE MAXIMUM RATINGS

- All Pins.....6V
- nFAULT Current25mA
- Power Dissipation, P_D @ T_A = +25°C
- SOT-23-5.....0.3W
- Package Thermal Resistance
- SOT-23-5, θ_{JA}220°C/W
- SOT-23-5, θ_{JC}93°C/W
- Junction Temperature.....+150°C
- Storage Temperature Range.....-65°C to +150°C
- Lead Temperature (Soldering, 10s).....+260°C
- ESD Susceptibility
- HBM.....2000V
- MM.....400V
- CDM1000V

RECOMMENDED OPERATING CONDITIONS

- Input Voltage Range.....2.5V to 5.5V
- EN Voltage Range.....-0.3V to 5.5V
- All Other Pins.....0V to 5.5V
- Operating Junction Temperature Range.....-40°C to +125°C
- Operating Ambient Temperature Range.....-40°C to +85°C

OVERSTRESS CAUTION

Stresses beyond those listed in Absolute Maximum Ratings may cause permanent damage to the device. Exposure to absolute maximum rating conditions for extended periods may affect reliability. Functional operation of the device at any conditions beyond those indicated in the Recommended Operating Conditions section is not implied.

ESD SENSITIVITY CAUTION

This integrated circuit can be damaged if ESD protections are not considered carefully. SGMICRO recommends that all integrated circuits be handled with appropriate precautions. Failure to observe proper handling and installation procedures can cause damage. ESD damage can range from subtle performance degradation to complete device failure. Precision integrated circuits may be more susceptible to damage because even small parametric changes could cause the device not to meet the published specifications.

DISCLAIMER

SG Micro Corp reserves the right to make any change in circuit design, or specifications without prior notice.

PIN CONFIGURATIONS

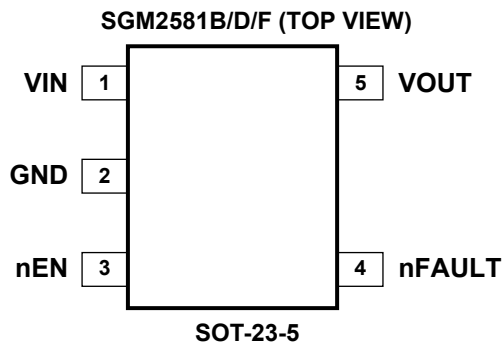
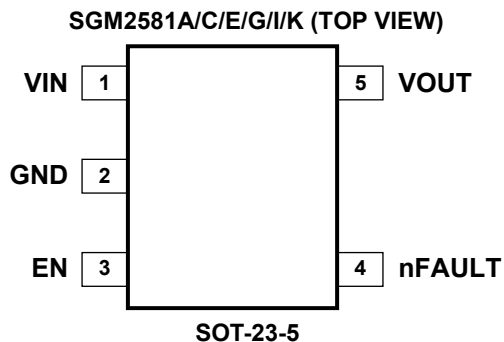

PIN DESCRIPTION

PIN	NAME	FUNCTION
1	VIN	Switch Input Pin.
2	GND	Ground.
3	EN/nEN	Chip Enable Pin. Do not floating for SGM2581A/B/C/D/E/F. Active high for SGM2581A/C/E/G/I/K (EN) and active low for SGM2581B/D/F (nEN). SGM2581G/I/K have integrated a 500kΩ pull-down resistor at EN PIN.
4	nFAULT	Fault Flag Pin. Active low, open-drain output. Indicates over-current or thermal shutdown conditions. Over-current condition must last longer than t_D in order to assert nFAULT.
5	VOUT	Switch Output Pin.

ELECTRICAL CHARACTERISTICS

(T_A = +25°C, V_{IN} = 5V, unless otherwise noted.)

PARAMETER		SYMBOL	CONDITIONS	MIN	TYP	MAX	UNITS
Input Voltage Range		V _{IN}		2.5		5.5	V
Quiescent Supply Current		I _Q	Switch on, V _{OUT} = Open		23	35	μA
Shutdown Supply Current		I _{SD}	Switch off, V _{OUT} = Open		0.1		μA
Supply Leakage Current (SGM2581A/B/C/D/E/F)		I _{LEAKAGE}	Switch off, V _{OUT} = 0V		0.1		μA
Output Leakage Current (SGM2581G/I/K)			Switch off, V _{OUT} = 5V		0.1		μA
Enable Input Threshold		V _{IH}	V _{IN} = 2.5V to 5.5V	1.6			V
		V _{IL}	V _{IN} = 2.5V to 5.5V			0.4	
Enable Input Current (SGM2581A/B/C/D/E/F)		I _{EN}	V _{EN} = 0V to 5V		0.1		μA
EN Pin Pull-Down Resistor (SGM2581G/I/K)		R _{PULL_DOWN}			500		kΩ
Switch Resistance		R _{DS(ON)}	I _{OUT} = 500mA		100		mΩ
Output Turn-On Delay Time		t _{ON}	R _L = 10Ω, C _L = 1μF, Figure 3		2.3		ms
Output Turn-Off Delay Time		t _{OFF}	R _L = 10Ω, C _L = 1μF, Figure 3		25		μs
Current Limit Threshold	SGM2581A/B/G	I _{LIM}	Ramped load	990	1100	1210	mA
	SGM2581C/D/I		Ramped load	1880	2100	2320	
	SGM2581E/F/K		Ramped load	2290	2600	2910	
Over-Current nFAULT Response Delay Time		t _D	Apply V _{OUT} = 0 until nFAULT is low		13		ms
Under-Voltage Lockout Threshold		V _{UVLO}	V _{IN} rising		2.15	2.3	V
Under-Voltage Lockout Threshold Hysteresis					0.1		V
nFAULT Output Resistance		R _{nFAULT}	nFAULT is low and I _{SINK} = 10mA		20		Ω
nFAULT Leakage Current		I _{nFAULT}	nFAULT is high		0.1		μA
VO _{UT} Shutdown Discharge Resistance (SGM2581A/B/C/D/E/F)		R _{DIS}	Switch off		50		Ω
Thermal Shutdown Temperature			T _J increasing		150		°C
Thermal Shutdown Hysteresis					20		°C

TYPICAL PERFORMANCE CHARACTERISTICS

T_A = +25°C, V_{IN} = 5V, unless otherwise noted.

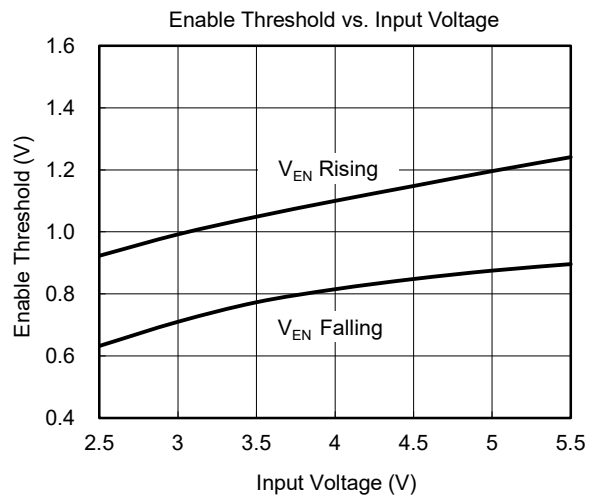
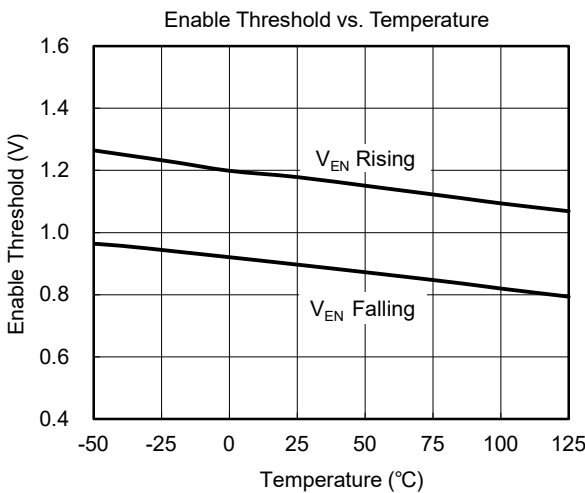
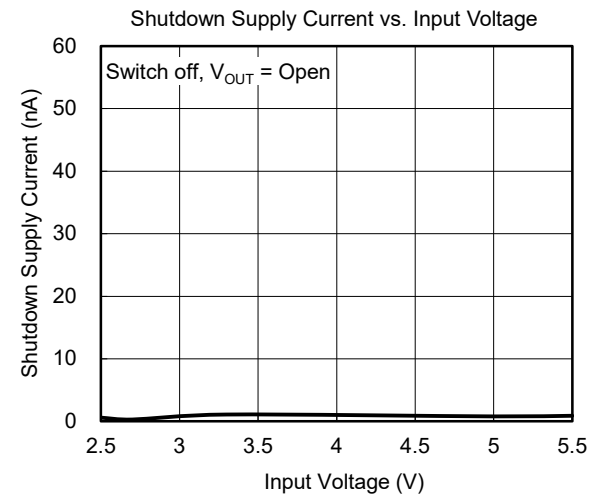
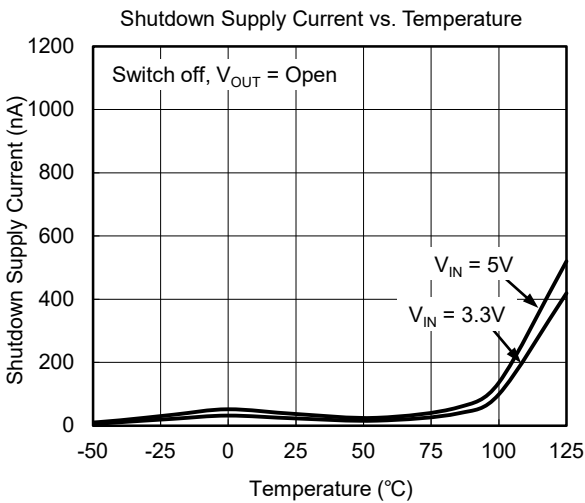
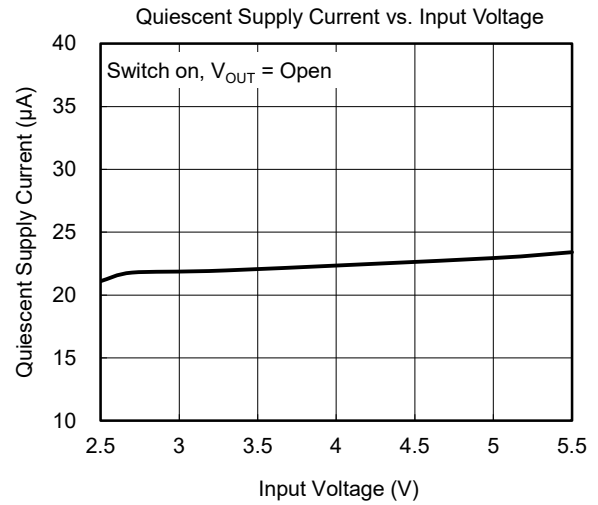
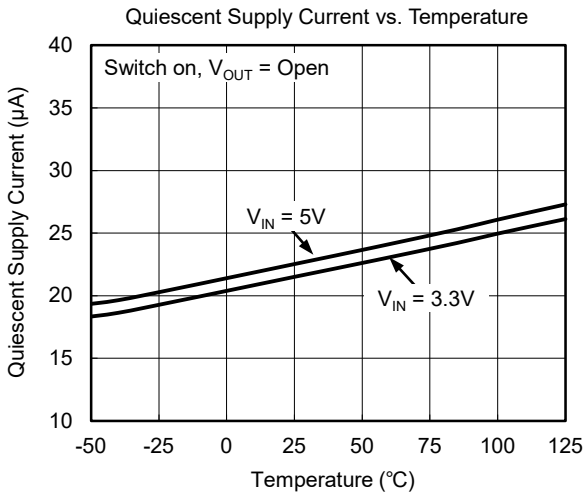

TYPICAL PERFORMANCE CHARACTERISTICS (continued)

T_A = +25°C, V_{IN} = 5V, unless otherwise noted.

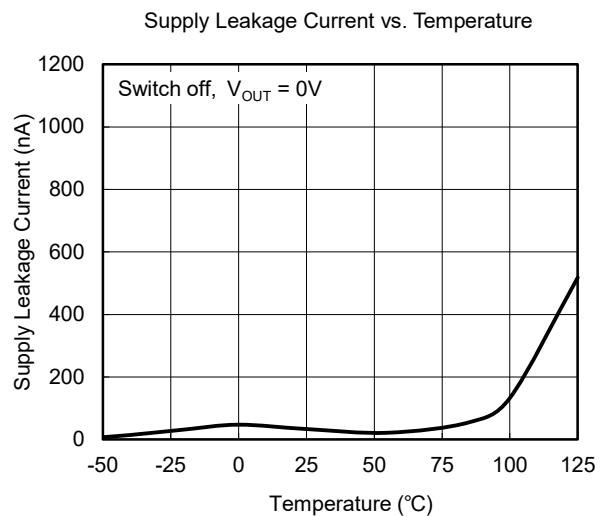
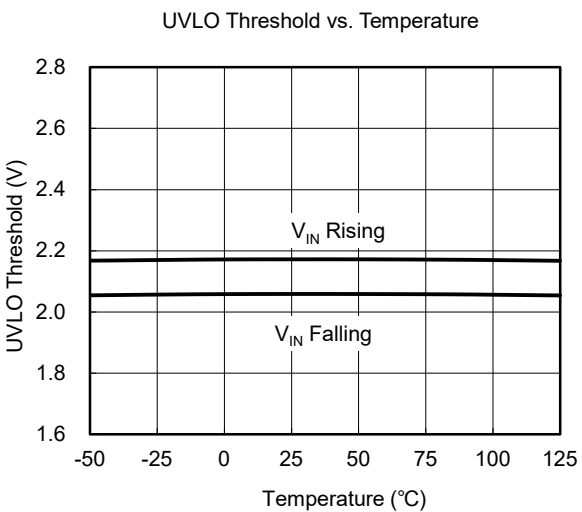
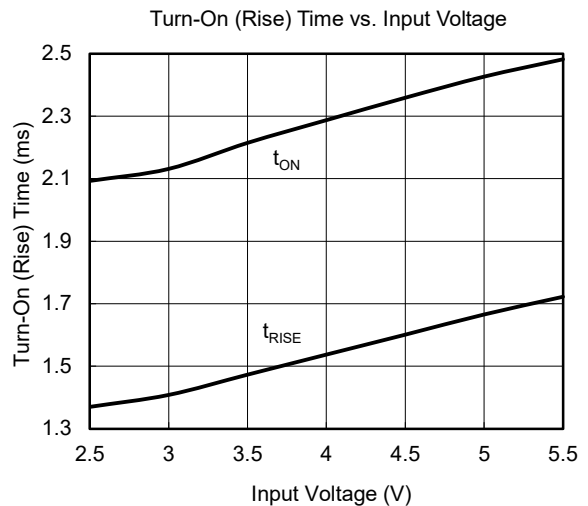
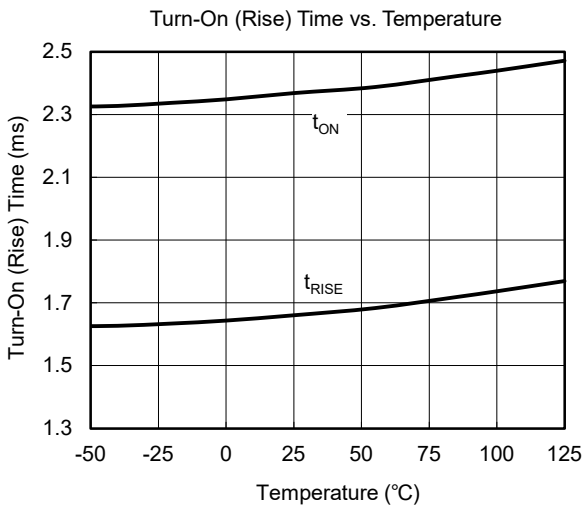
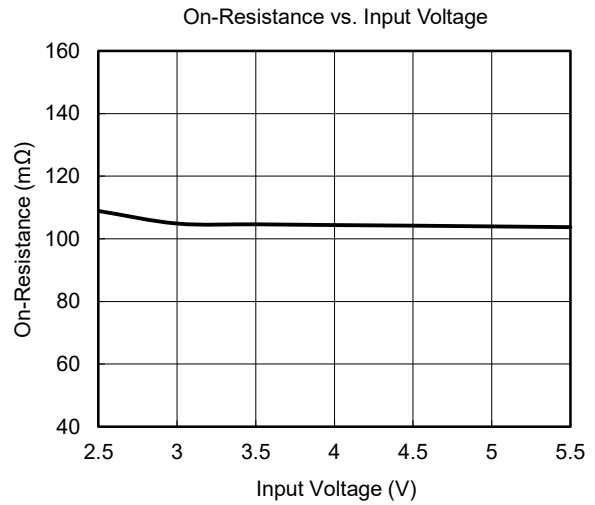
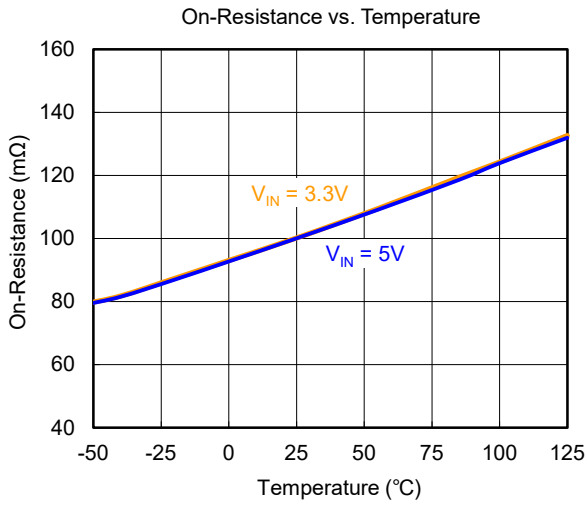

TYPICAL PERFORMANCE CHARACTERISTICS (continued)

T_A = +25°C, V_{IN} = 5V, unless otherwise noted.

Short-Circuit Current Limit vs. Temperature
(SGM2581A/B/G)

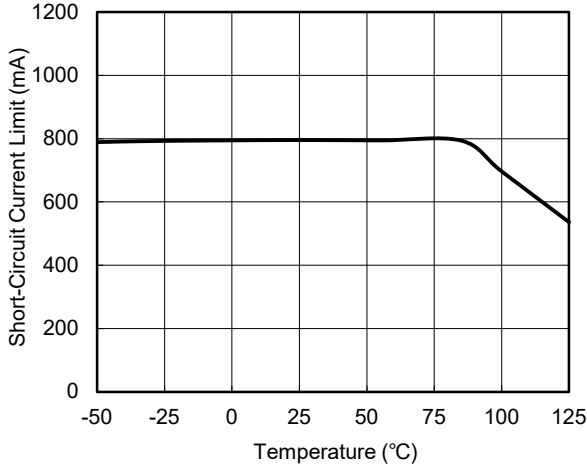

Short-Circuit Current Limit vs. Input Voltage
(SGM2581A/B/G)

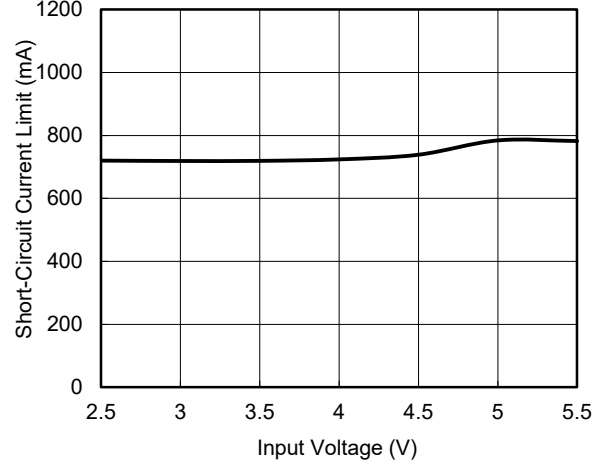

Current Limit Threshold vs. Temperature
(SGM2581A/B/G)

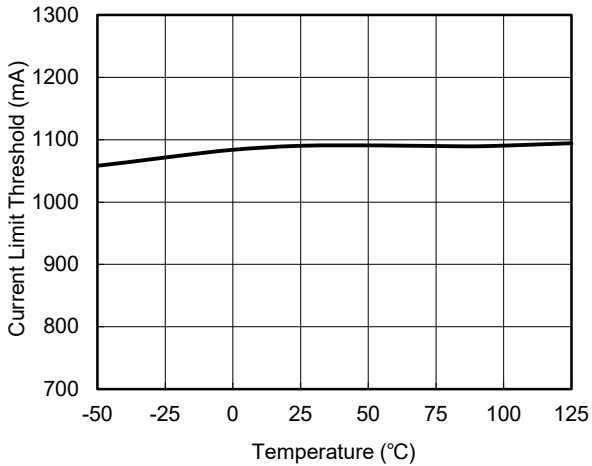

Current Limit Threshold vs. Input Voltage
(SGM2581A/B/G)

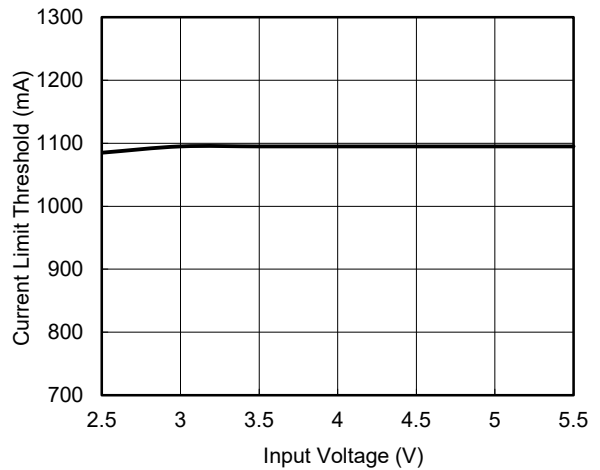

Current Limit Threshold vs. Input Voltage
(SGM2581C/D/I)

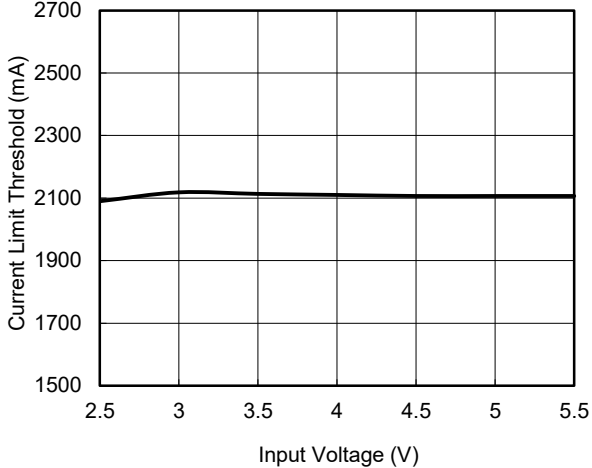

Current Limit Threshold vs. Input Voltage
(SGM2581E/F/K)

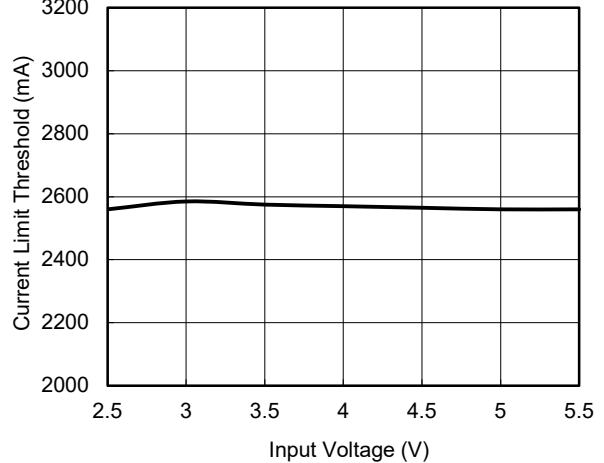

TYPICAL PERFORMANCE CHARACTERISTICS (continued)

T_A = +25°C, V_{IN} = 5V, unless otherwise noted.

Turn-On Response (SGM2581A/C/E/G/I/K)

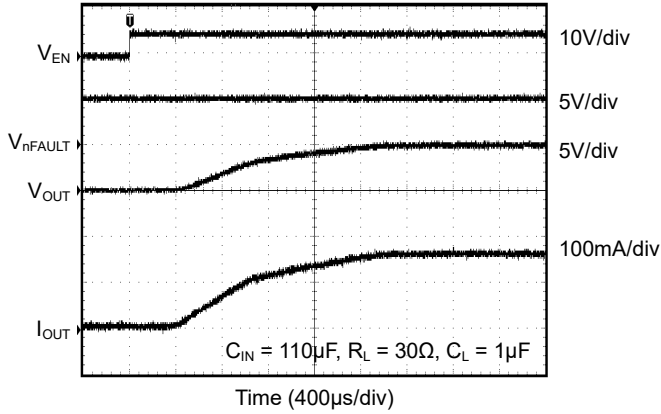

Turn-Off Response (SGM2581A/C/E/G/I/K)

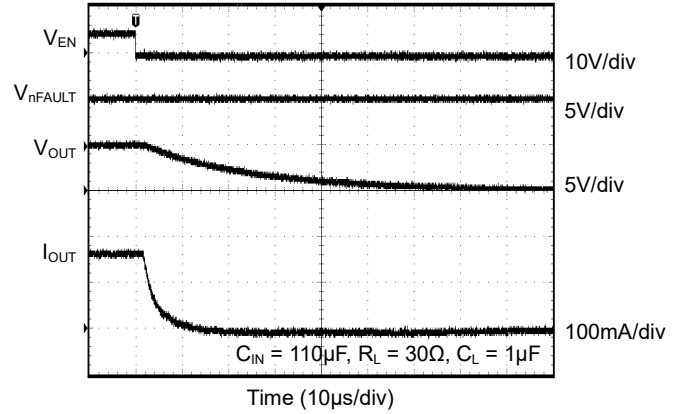

UVLO at V_{IN} Rising

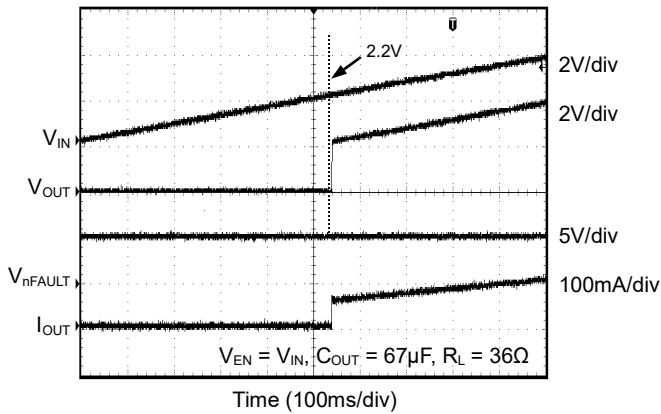

UVLO at V_{IN} Falling

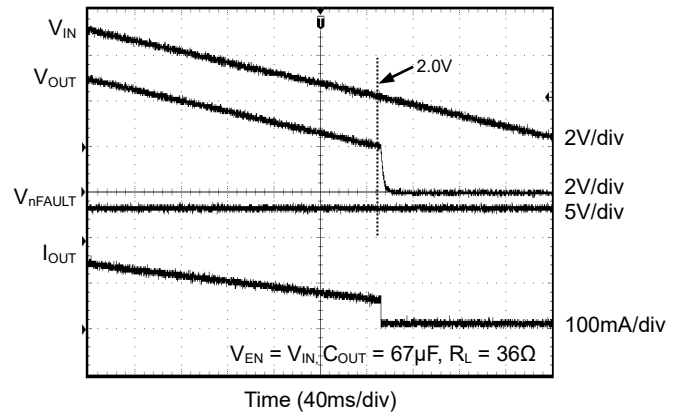

Short-Circuit Response (SGM2581A/B/G)

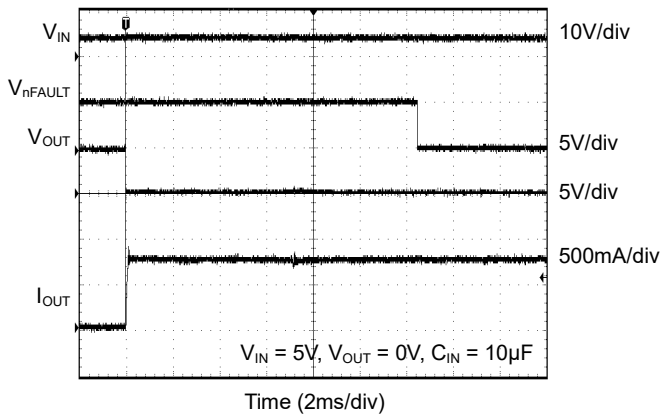

Short-Circuit Response (SGM2581A/B/G)

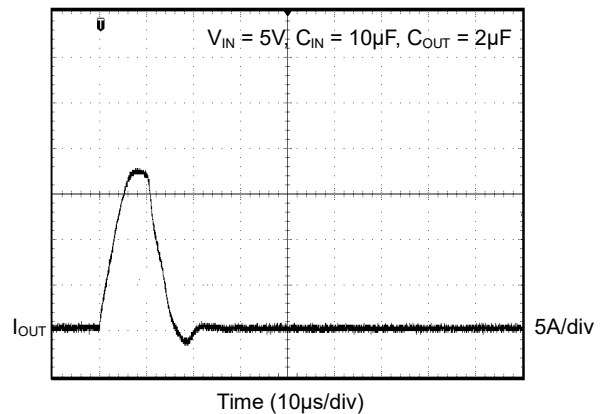

TYPICAL PERFORMANCE CHARACTERISTICS (continued)

T_A = +25°C, V_{IN} = 5V, unless otherwise noted.

Enabled Into Short-Circuit (SGM2581A/G)

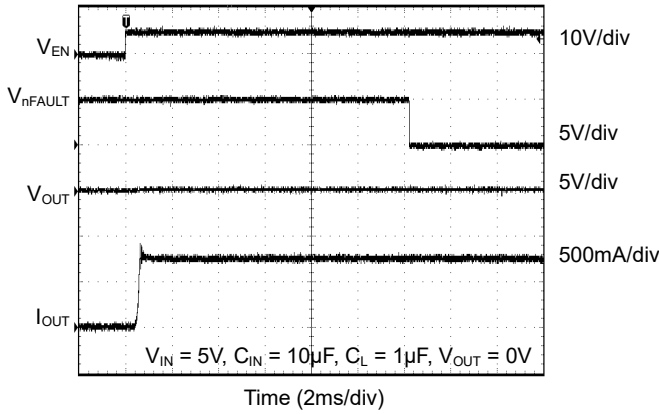

Thermal Shutdown Response (SGM2581A/G)

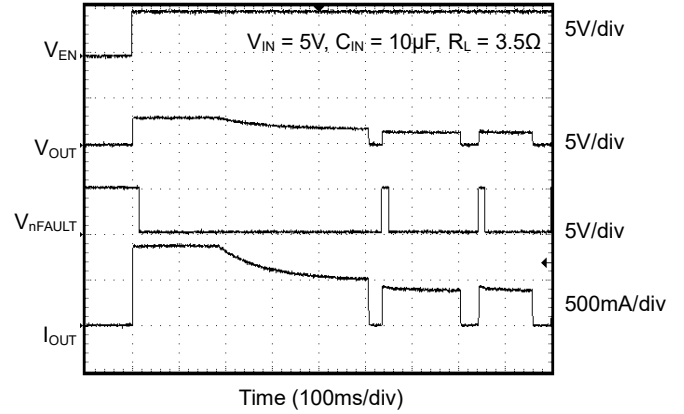

Inrush Current Response (SGM2581A/G)

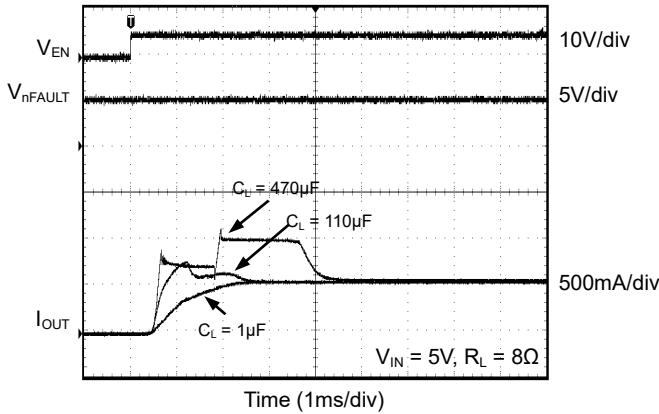

Inrush Current Response (SGM2581C/I)

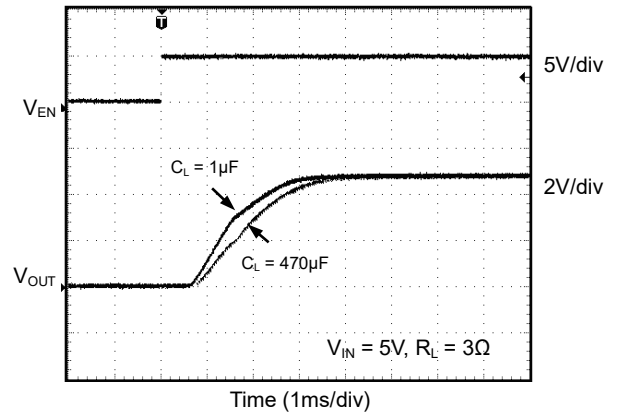

Inrush Current Response (SGM2581E/K)

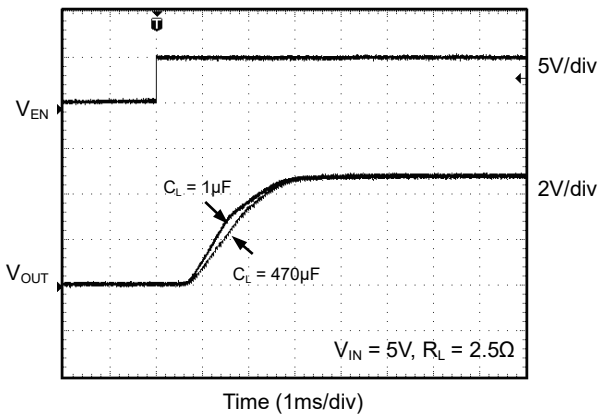

TYPICAL PERFORMANCE CHARACTERISTICS (continued)

T_A = +25°C, V_{IN} = 5V, unless otherwise noted.

Capacitance Load Inrush Response (SGM2581A/B/G)

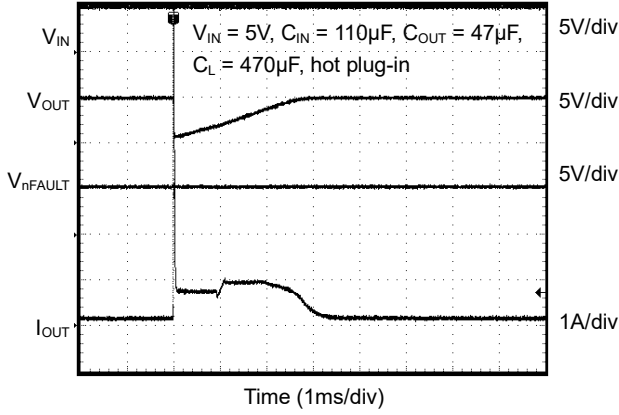

Capacitance Load Inrush Response (SGM2581A/B/G)

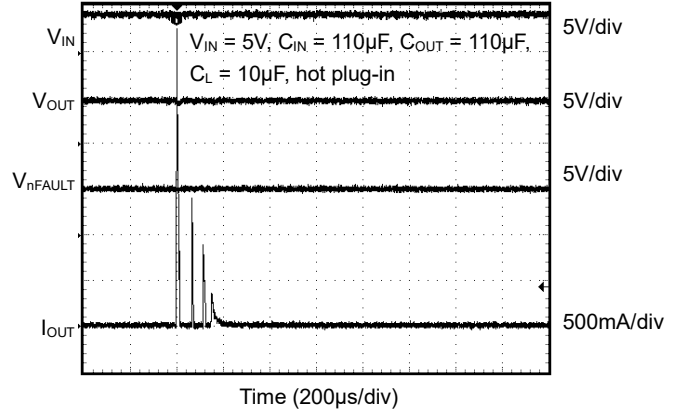

Ramped Load Response (SGM2581A/B/G)

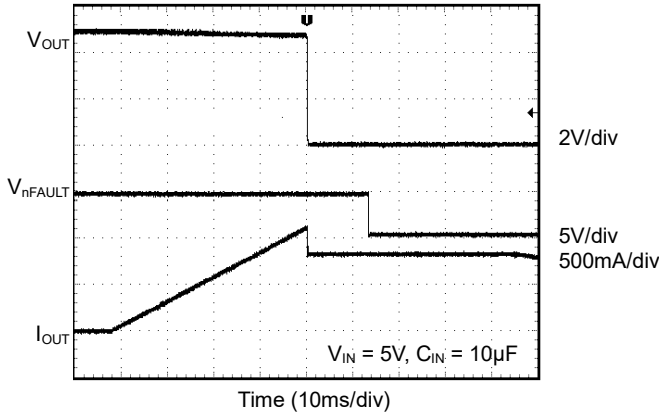

Ramped Load Response (SGM2581E/F/K)

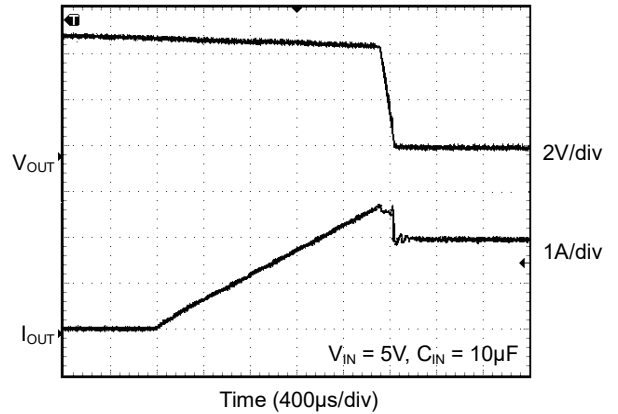

Resistance Load Inrush Response (SGM2581A/B/G)

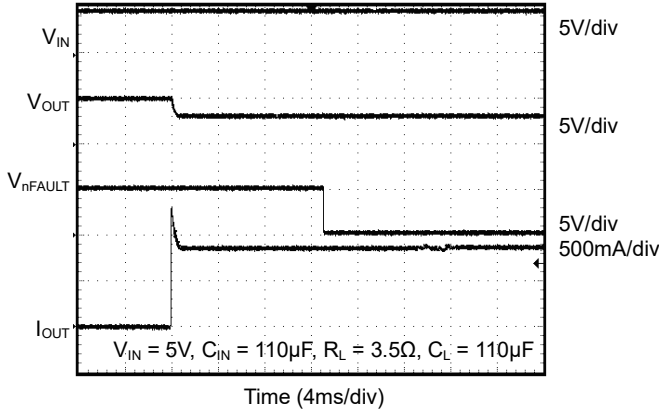

FUNCTIONAL BLOCK DIAGRAM

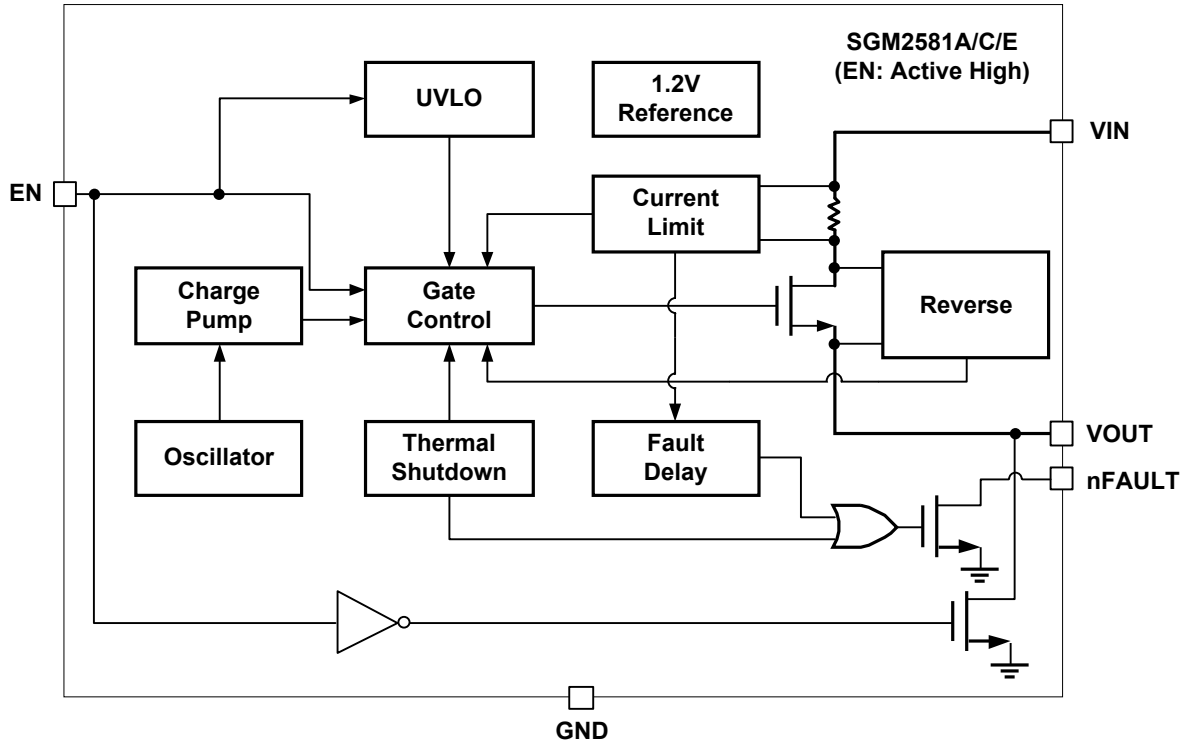

Figure 1. SGM2581A/C/E Block Diagram

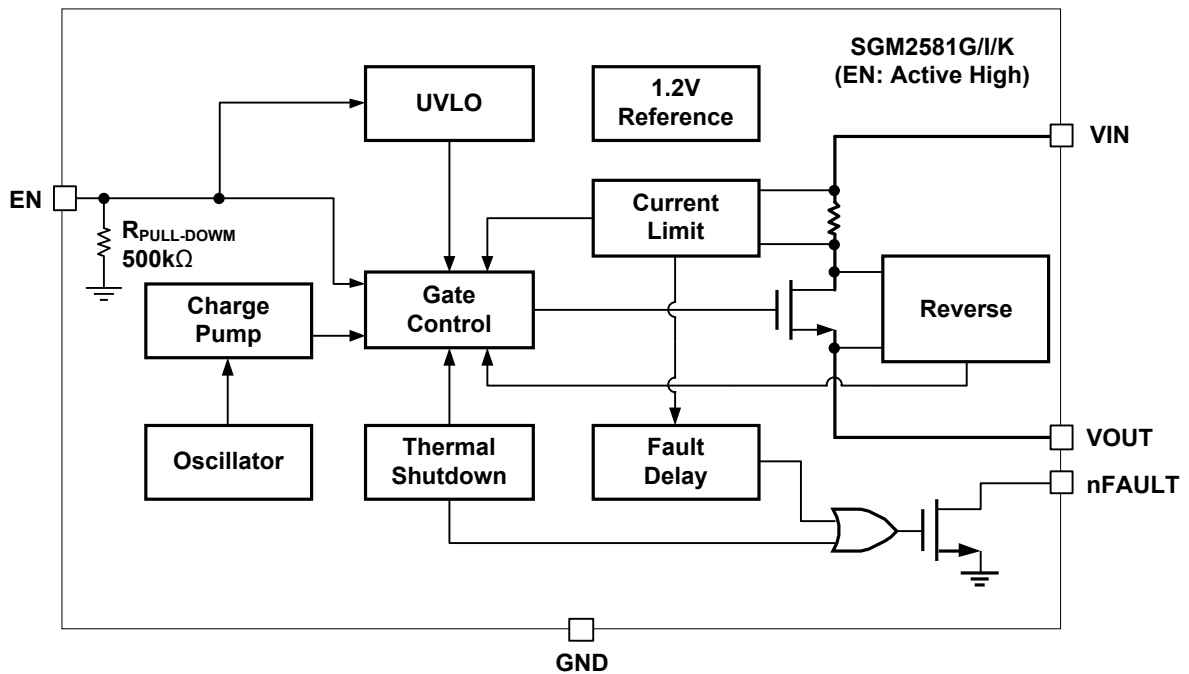

Figure 2. SGM2581G//K Block Diagram

REVISION HISTORY

NOTE: Page numbers for previous revisions may differ from page numbers in the current version.

FEBRUARY 2019 – REV.A.2 to REV.A.3	Page
Update Absolute Maximum Ratings section.....	2
DECEMBER 2017 – REV.A.1 to REV.A.2	Page
Update Feature section	1
APRIL 2016 – REV.A to REV.A.1	Page
Changed Reverse-Voltage Protection section.....	10
Changes from Original (OCTOBER 2015) to REV.A	Page
Changed from product preview to production data.....	All

PACKAGE OUTLINE DIMENSIONS

SOT-23-5

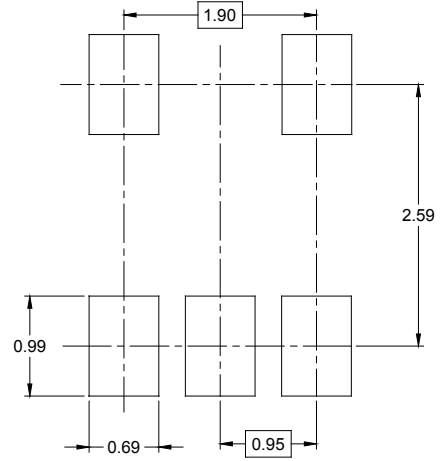
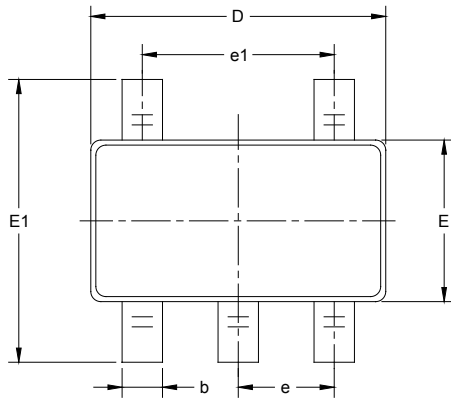

RECOMMENDED LAND PATTERN (Unit: mm)

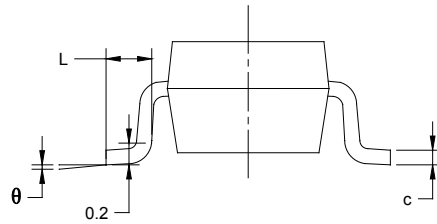
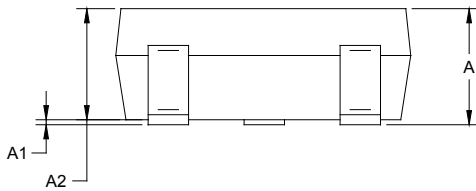

Symbol	Dimensions In Millimeters		Dimensions In Inches	
	MIN	MAX	MIN	MAX
A	1.050	1.250	0.041	0.049
A1	0.000	0.100	0.000	0.004
A2	1.050	1.150	0.041	0.045
b	0.300	0.500	0.012	0.020
c	0.100	0.200	0.004	0.008
D	2.820	3.020	0.111	0.119
E	1.500	1.700	0.059	0.067
E1	2.650	2.950	0.104	0.116
e	0.950 BSC		0.037 BSC	
e1	1.900 BSC		0.075 BSC	
L	0.300	0.600	0.012	0.024
θ	0°	8°	0°	8°

PACKAGE INFORMATION

TAPE AND REEL INFORMATION

REEL DIMENSIONS



TAPE DIMENSIONS



NOTE: The picture is only for reference. Please make the object as the standard.

KEY PARAMETER LIST OF TAPE AND REEL

Package Type	Reel Diameter	Reel Width W1 (mm)	A0 (mm)	B0 (mm)	K0 (mm)	P0 (mm)	P1 (mm)	P2 (mm)	W (mm)	Pin1 Quadrant
SOT-23-5	7"	9.5	3.20	3.20	1.40	4.0	4.0	2.0	8.0	Q3

000001

PACKAGE INFORMATION

CARTON BOX DIMENSIONS



NOTE: The picture is only for reference. Please make the object as the standard.

KEY PARAMETER LIST OF CARTON BOX

Reel Type	Length (mm)	Width (mm)	Height (mm)	Pizza/Carton
7" (Option)	368	227	224	8
7"	442	410	224	18

DD0002