



# SGM8210-1/SGM8210-2/SGM8210-4

## High Voltage, Low Noise, Rail-to-Rail I/O Operational Amplifiers

---

### GENERAL DESCRIPTION

The SGM8210-1 (single), SGM8210-2 (dual) and SGM8210-4 (quad) are low power and high voltage operational amplifiers suitable for battery-powered systems. These devices can operate from 3.3V to 24V single supply, while consuming only 50 $\mu$ A/Amplifier quiescent current. They also provide rail-to-rail input and output operation.

The SGM8210-1/2/4 provide low power, low bias current and low noise. These devices fit in small packages. The combination of above features makes them suitable for various applications.

The SGM8210-1 is available in Green SOT-23-5 and SC70-5 packages. The SGM8210-2 is available in Green SOIC-8, MSOP-8 and TDFN-2 $\times$ 3-8L packages. The SGM8210-4 is available in a Green SOIC-14 package. They are specified over the extended industrial temperature range (-40 $^{\circ}$ C to +125 $^{\circ}$ C).

### FEATURES

- **Wide Supply Voltage Range: 3.3V to 24V**
- **Rail-to-Rail Input and Output**
- **Low Quiescent Current: 50 $\mu$ A/Amplifier (TYP)**
- **Low Offset Voltage: 1mV (MAX)**
- **Low 0.1Hz to 10Hz Noise: 3 $\mu$ V<sub>P-P</sub>**
- **Input Voltage Noise Density: 25nV/ $\sqrt{\text{Hz}}$  at 1kHz**
- **CMRR: 115dB**
- **PSRR: 120dB**
- **Open-Loop Voltage Gain: 120dB**
- **Slew Rate: 0.3V/ $\mu$ s**
- **-40 $^{\circ}$ C to +125 $^{\circ}$ C Operating Temperature Range**
- **Small Packaging:**
  - SGM8210-1 Available in Green SOT-23-5 and SC70-5 Packages**
  - SGM8210-2 Available in Green SOIC-8, MSOP-8 and TDFN-2 $\times$ 3-8L Packages**
  - SGM8210-4 Available in a Green SOIC-14 Package**

### APPLICATIONS

Notebook Computers  
Welding Equipment  
Battery Chargers  
Power Managements  
Telecom Equipment  
Cell Phones

**PACKAGE/ORDERING INFORMATION**

MODEL	PACKAGE DESCRIPTION	SPECIFIED TEMPERATURE RANGE	ORDERING NUMBER	PACKAGE MARKING	PACKING OPTION
SGM8210-1	SOT-23-5	-40°C to +125°C	SGM8210-1AXN5G/TR	G1BXX	Tape and Reel, 3000
	SOT-23-5	-40°C to +125°C	SGM8210-1BXN5G/TR	G8AXX	Tape and Reel, 3000
	SC70-5	-40°C to +125°C	SGM8210-1XC5G/TR	G87XX	Tape and Reel, 3000
SGM8210-2	SOIC-8	-40°C to +125°C	SGM8210-2XS8G/TR	SGM 82102XS8 XXXXX	Tape and Reel, 2500
	MSOP-8	-40°C to +125°C	SGM8210-2XMS8G/TR	SGM82102 XMS8 XXXXX	Tape and Reel, 4000
	TDFN-2×3-8L	-40°C to +125°C	SGM8210-2XTDC8G/TR	G8B XXXX	Tape and Reel, 3000
SGM8210-4	SOIC-14	-40°C to +125°C	SGM8210-4XS14G/TR	SGM82104XS14 XXXXX	Tape and Reel, 2500

**MARKING INFORMATION**

NOTE: XX = Date Code. XXXX = Date Code. XXXXX = Date Code and Vendor Code.

**SOT-23-5/SC70-5**

**YYY X X**

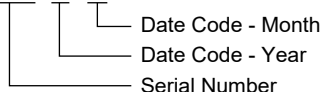

**SOIC-8/MSOP-8/SOIC-14**

**XXXXX**

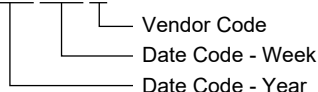

**TDFN-2×3-8L**

**YYY** — Serial Number

**XXXX**

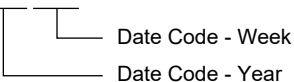

Green (RoHS & HSF): SG Micro Corp defines "Green" to mean Pb-Free (RoHS compatible) and free of halogen substances. If you have additional comments or questions, please contact your SGMICRO representative directly.

**ABSOLUTE MAXIMUM RATINGS**

Supply Voltage, +V <sub>S</sub> to -V <sub>S</sub> .....	26V
Signal Input Terminals, Voltage ..... (-V <sub>S</sub> ) - 0.3V to (+V <sub>S</sub> ) + 0.3V	
Differential Input Voltage.....	±2V
Signal Input Terminals, Current.....	±10mA
Output Short-Circuit Current.....	±40mA
Junction Temperature.....	+150°C
Storage Temperature Range.....	-65°C to +150°C
Lead Temperature (Soldering, 10s).....	+260°C
ESD Susceptibility	
HBM.....	8000V
MM.....	200V
CDM.....	1000V

**RECOMMENDED OPERATING CONDITIONS**

Input Voltage Range.....	3.3V to 24V
Operating Temperature Range.....	-40°C to +125°C

**OVERSTRESS CAUTION**

Stresses beyond those listed in Absolute Maximum Ratings may cause permanent damage to the device. Exposure to absolute maximum rating conditions for extended periods may affect reliability. Functional operation of the device at any conditions beyond those indicated in the Recommended Operating Conditions section is not implied.

**ESD SENSITIVITY CAUTION**

This integrated circuit can be damaged if ESD protections are not considered carefully. SGMICRO recommends that all integrated circuits be handled with appropriate precautions. Failure to observe proper handling and installation procedures can cause damage. ESD damage can range from subtle performance degradation to complete device failure. Precision integrated circuits may be more susceptible to damage because even small parametric changes could cause the device not to meet the published specifications.

**DISCLAIMER**

SG Micro Corp reserves the right to make any change in circuit design, or specifications without prior notice.

**PIN CONFIGURATIONS**

**SGM8210-1AXN5G (TOP VIEW)**

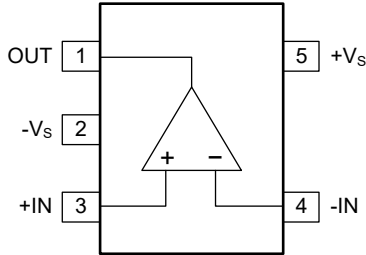

**SOT-23-5**

**SGM8210-1BXN5G/SGM8210-1XC5G  
(TOP VIEW)**

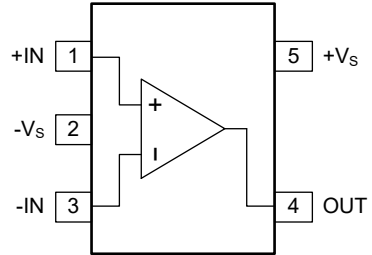

**SOT-23-5/SC70-5**

**SGM8210-2 (TOP VIEW)**

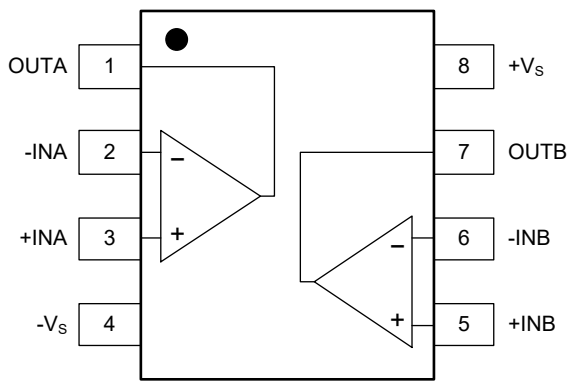

**SOIC-8/MSOP-8**

**SGM8210-2 (TOP VIEW)**

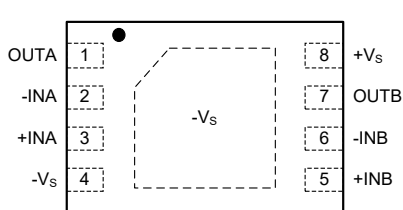

**TDFN-2x3-8L**

**SGM8210-4 (TOP VIEW)**

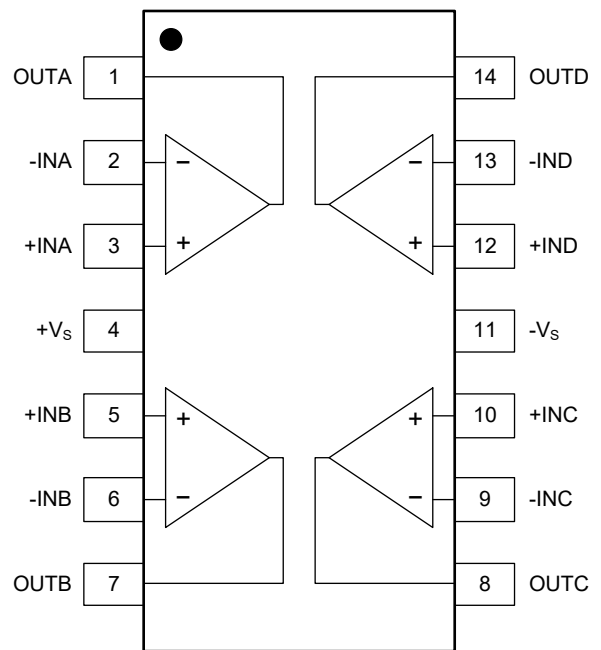

**SOIC-14**

**ELECTRICAL CHARACTERISTICS**

(At  $T_A = +25^\circ\text{C}$ ,  $V_S = 3.3\text{V}$  to  $24\text{V}$ ,  $R_L = 10\text{k}\Omega$  connected to  $V_S/2$ , and  $V_{CM} < (+V_S) - 1\text{V}$ , Full =  $-40^\circ\text{C}$  to  $+125^\circ\text{C}$ , unless otherwise noted.)

PARAMETER	SYMBOL	CONDITIONS	TEMP	MIN	TYP	MAX	UNITS
<b>Input Characteristics</b>							
Input Offset Voltage	$V_{OS}$		+25°C		0.4	1	mV
			Full			1.2	
Input Offset Voltage Drift	$\Delta V_{OS}/\Delta T$		+25°C		1		$\mu\text{V}/^\circ\text{C}$
Input Bias Current	$I_B$	$V_{CM} = V_S/2$	+25°C		$\pm 5$		pA
Input Offset Current	$I_{OS}$	$V_{CM} = V_S/2$	+25°C		$\pm 5$		pA
Input Common Mode Voltage Range	$V_{CM}$		+25°C	$(-V_S) - 0.1$		$(+V_S) + 0.1$	V
Common Mode Rejection Ratio	CMRR	$V_S = 24\text{V}$ , $(-V_S) < V_{CM} < (+V_S) - 1\text{V}$	+25°C	98	115		dB
			Full	92			
Open-Loop Voltage Gain	$A_{OL}$	$R_L = 10\text{k}\Omega$ , $(-V_S) + 0.2\text{V} < V_{OUT} < (+V_S) - 0.2\text{V}$	+25°C	102	120		dB
			Full	84			
		$R_L = 2\text{k}\Omega$ , $(-V_S) + 0.6\text{V} < V_{OUT} < (+V_S) - 0.6\text{V}$	+25°C	96	110		
			Full	65			
<b>Output Characteristics</b>							
Output Voltage Swing from Rail	$V_{OUT}$	$V_S = 24\text{V}$ , $R_L = 10\text{k}\Omega$	+25°C		55	83	mV
			Full			110	
		$V_S = 24\text{V}$ , $R_L = 2\text{k}\Omega$	+25°C		270	380	
			Full			510	
Output Short-Circuit Current	$I_{SC}$		+25°C	$\pm 29$	$\pm 40$		mA
<b>Power Supply</b>							
Operating Voltage Range	$V_S$		+25°C	3.3		24	V
Quiescent Current/Amplifier	$I_Q$	$I_{OUT} = 0$	+25°C		50	72	$\mu\text{A}$
			Full			75	
Power Supply Rejection Ratio	PSRR		+25°C	104	120		dB
			Full	102			
<b>Dynamic Performance (<math>C_{LOAD} = 30\text{pF}</math>)</b>							
Gain-Bandwidth Product	GBP		+25°C		1		MHz
Slew Rate	SR	$G = +1$	+25°C		0.3		$\text{V}/\mu\text{s}$
Overload Recovery Time		$V_{IN} \times G > V_S$	+25°C		3		$\mu\text{s}$
<b>Noise</b>							
Input Voltage Noise		$f = 0.1\text{Hz}$ to $10\text{Hz}$	+25°C		3		$\mu\text{V}_{P-P}$
Input Voltage Noise Density	$e_n$	$f = 1\text{kHz}$	+25°C		25		$\text{nV}/\sqrt{\text{Hz}}$
Input Current Noise Density	$i_n$	$f = 1\text{kHz}$	+25°C		400		$\text{fA}/\sqrt{\text{Hz}}$

**TYPICAL PERFORMANCE CHARACTERISTICS**

At  $T_A = +25^\circ\text{C}$ ,  $V_S = 24\text{V}$ ,  $R_L = 10\text{k}\Omega$ , unless otherwise noted.

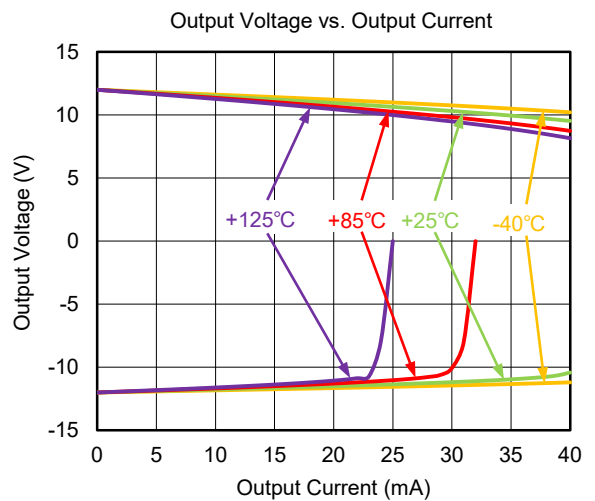
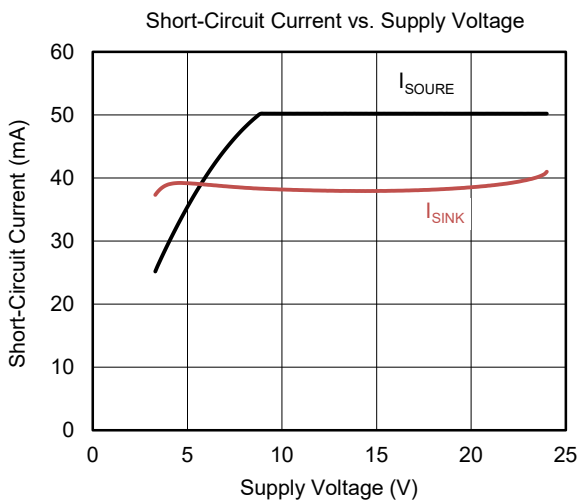
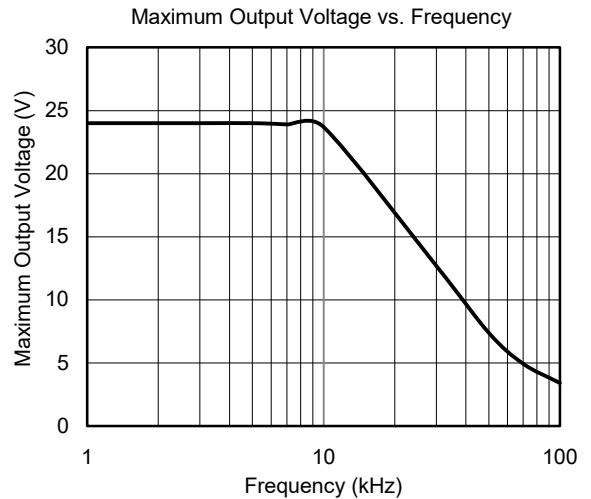
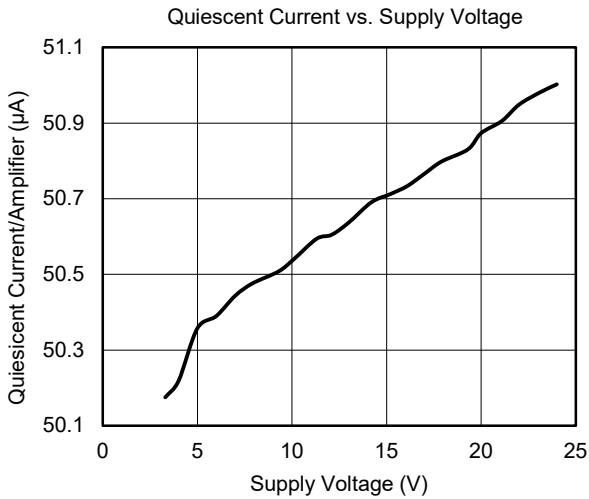
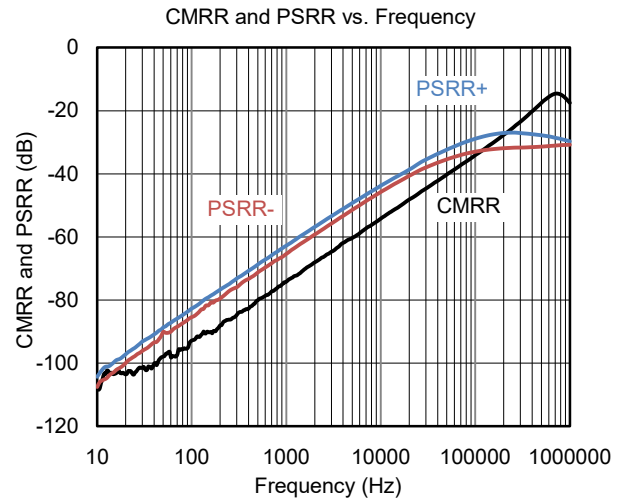
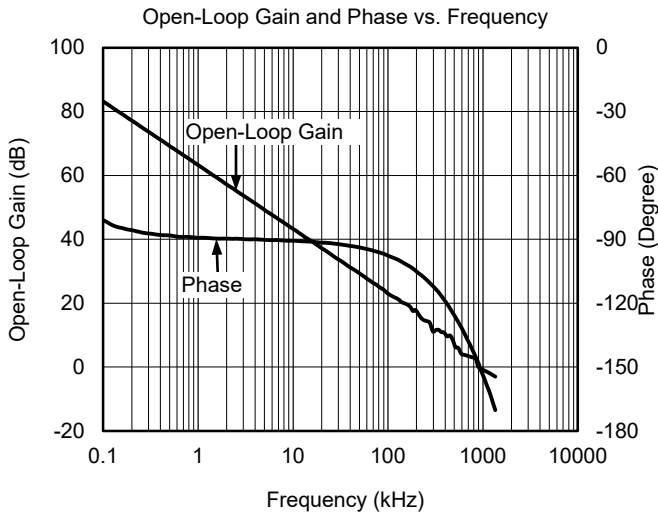

**TYPICAL PERFORMANCE CHARACTERISTICS (continued)**

At  $T_A = +25^\circ\text{C}$ ,  $V_S = 24\text{V}$ ,  $R_L = 10\text{k}\Omega$ , unless otherwise noted.

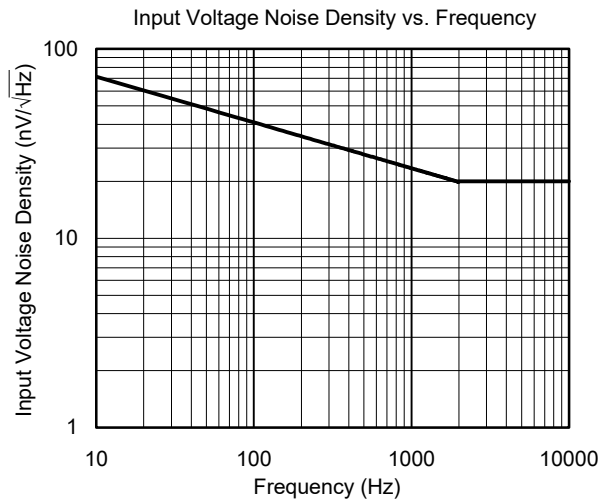
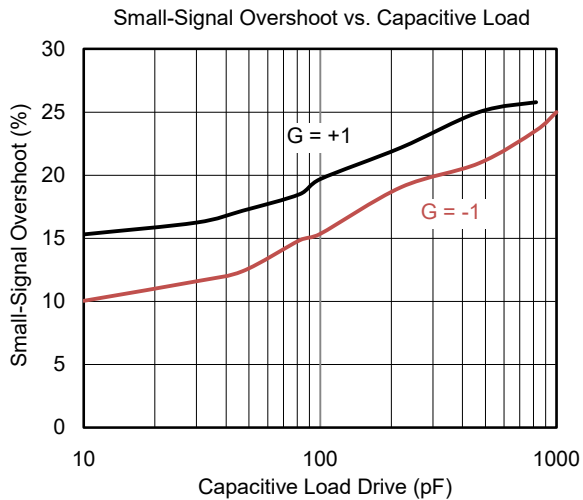
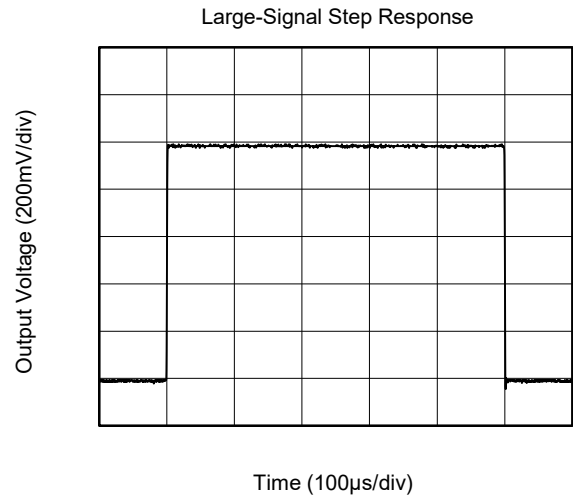
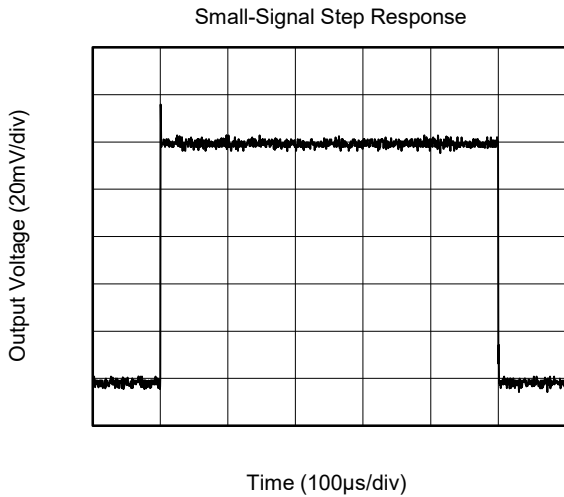
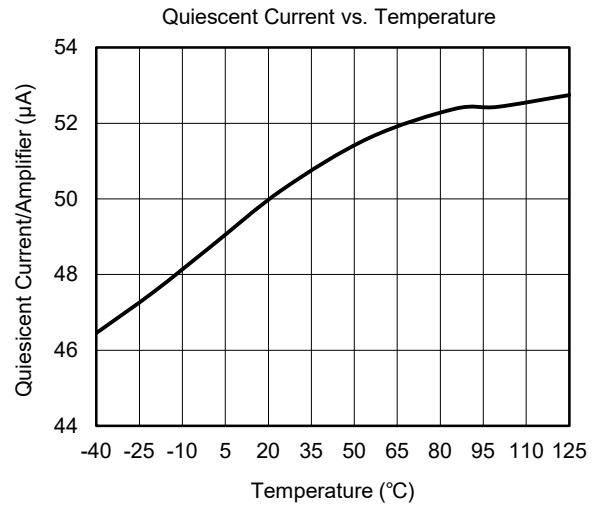
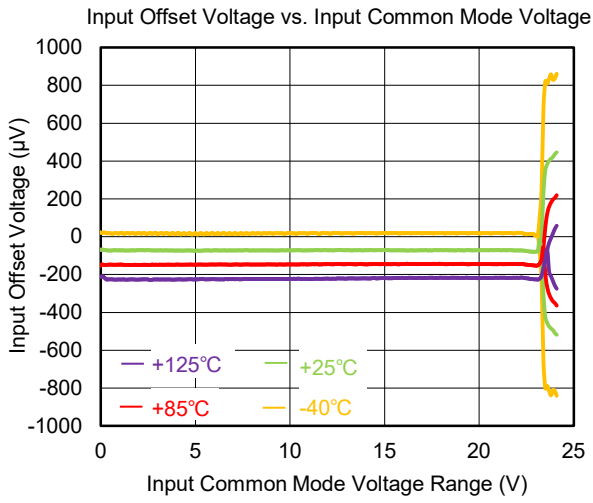

**TYPICAL PERFORMANCE CHARACTERISTICS (continued)**

At  $T_A = +25^\circ\text{C}$ ,  $V_S = 24\text{V}$ ,  $R_L = 10\text{k}\Omega$ , unless otherwise noted.

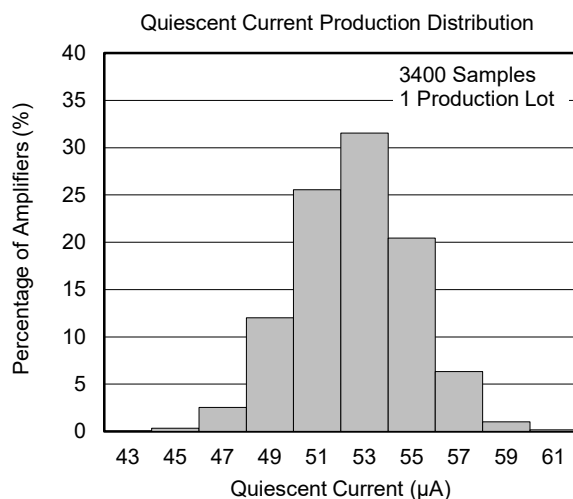
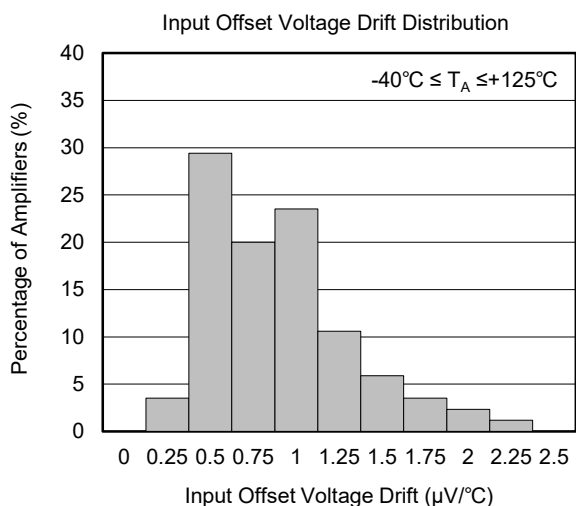
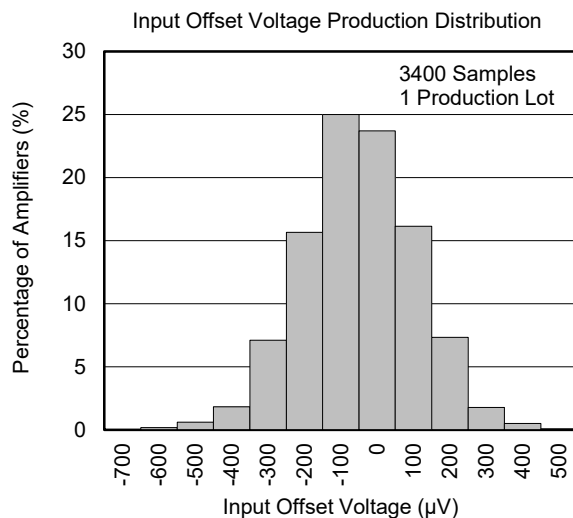
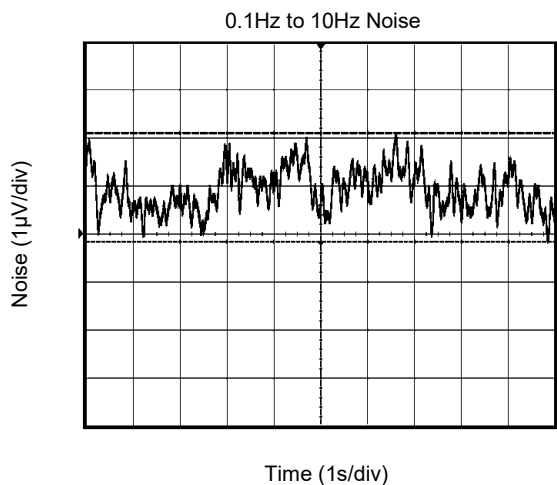



## **REVISION HISTORY**

NOTE: Page numbers for previous revisions may differ from page numbers in the current version.

<b>MARCH 2018 – REV.A to REV.A.1</b>	<b>Page</b>
Added Differential Input Voltage range .....	3

---

<b>Changes from Original (DECEMBER 2016) to REV.A</b>	<b>Page</b>
Changed from product preview to production data.....	All

---

PACKAGE OUTLINE DIMENSIONS

SOT-23-5

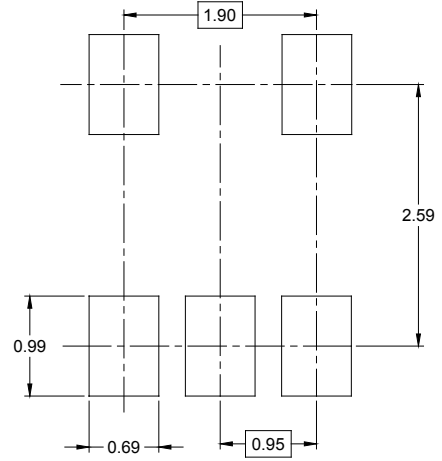

RECOMMENDED LAND PATTERN (Unit: mm)



Symbol	Dimensions In Millimeters		Dimensions In Inches	
	MIN	MAX	MIN	MAX
A	1.050	1.250	0.041	0.049
A1	0.000	0.100	0.000	0.004
A2	1.050	1.150	0.041	0.045
b	0.300	0.500	0.012	0.020
c	0.100	0.200	0.004	0.008
D	2.820	3.020	0.111	0.119
E	1.500	1.700	0.059	0.067
E1	2.650	2.950	0.104	0.116
e	0.950 BSC		0.037 BSC	
e1	1.900 BSC		0.075 BSC	
L	0.300	0.600	0.012	0.024
$\theta$	0°	8°	0°	8°

PACKAGE OUTLINE DIMENSIONS

SC70-5

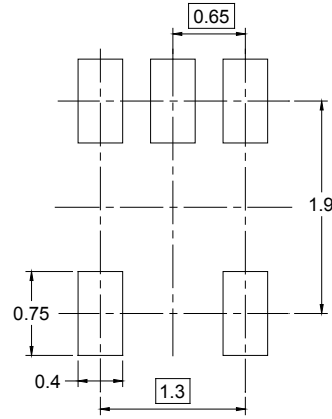
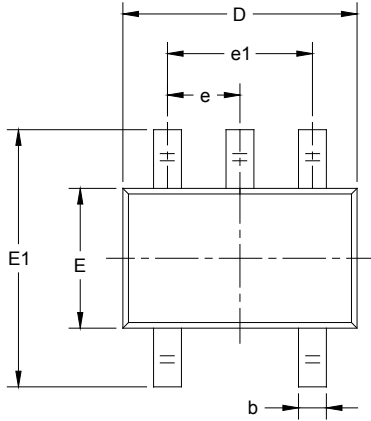

RECOMMENDED LAND PATTERN (Unit: mm)

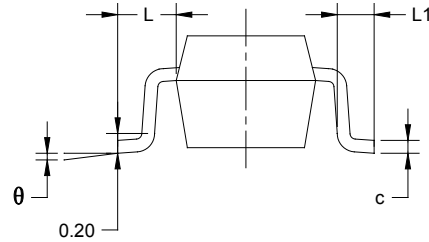
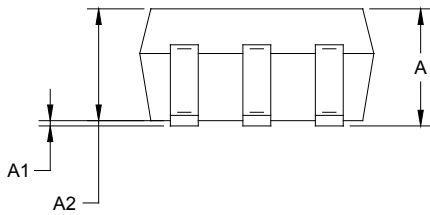

Symbol	Dimensions In Millimeters		Dimensions In Inches	
	MIN	MAX	MIN	MAX
A	0.900	1.100	0.035	0.043
A1	0.000	0.100	0.000	0.004
A2	0.900	1.000	0.035	0.039
b	0.150	0.350	0.006	0.014
c	0.080	0.150	0.003	0.006
D	2.000	2.200	0.079	0.087
E	1.150	1.350	0.045	0.053
E1	2.150	2.450	0.085	0.096
e	0.65 TYP		0.026 TYP	
e1	1.300 BSC		0.051 BSC	
L	0.525 REF		0.021 REF	
L1	0.260	0.460	0.010	0.018
$\theta$	0°	8°	0°	8°

PACKAGE OUTLINE DIMENSIONS

SOIC-8

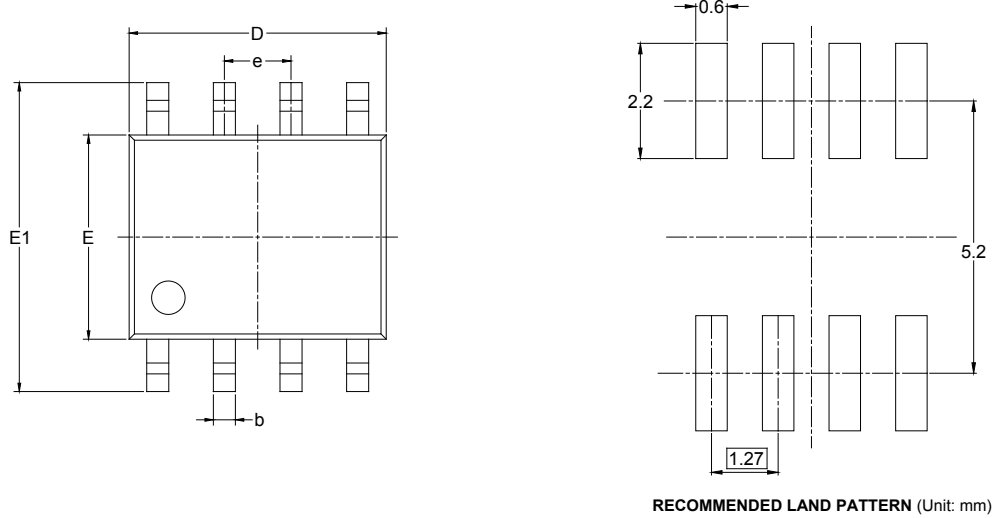

Symbol	Dimensions In Millimeters		Dimensions In Inches	
	MIN	MAX	MIN	MAX
A	1.350	1.750	0.053	0.069
A1	0.100	0.250	0.004	0.010
A2	1.350	1.550	0.053	0.061
b	0.330	0.510	0.013	0.020
c	0.170	0.250	0.006	0.010
D	4.700	5.100	0.185	0.200
E	3.800	4.000	0.150	0.157
E1	5.800	6.200	0.228	0.244
e	1.27 BSC		0.050 BSC	
L	0.400	1.270	0.016	0.050
$\theta$	0°	8°	0°	8°

PACKAGE OUTLINE DIMENSIONS

MSOP-8

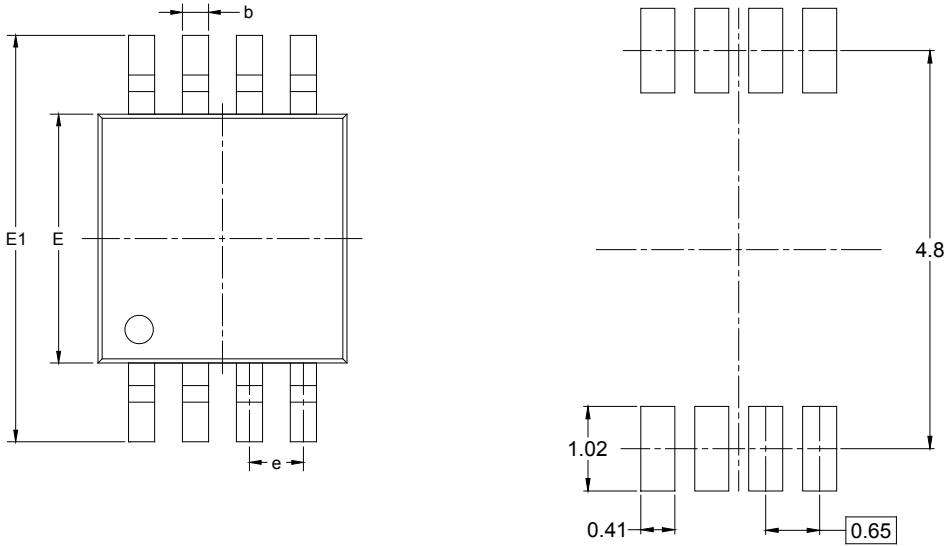

RECOMMENDED LAND PATTERN (Unit: mm)

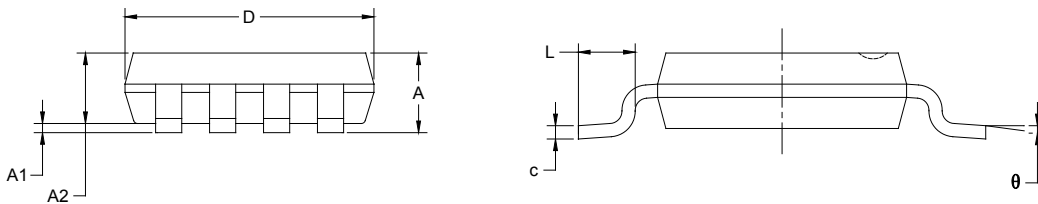

Symbol	Dimensions In Millimeters		Dimensions In Inches	
	MIN	MAX	MIN	MAX
A	0.820	1.100	0.032	0.043
A1	0.020	0.150	0.001	0.006
A2	0.750	0.950	0.030	0.037
b	0.250	0.380	0.010	0.015
c	0.090	0.230	0.004	0.009
D	2.900	3.100	0.114	0.122
E	2.900	3.100	0.114	0.122
E1	4.750	5.050	0.187	0.199
e	0.650 BSC		0.026 BSC	
L	0.400	0.800	0.016	0.031
θ	0°	6°	0°	6°

PACKAGE OUTLINE DIMENSIONS

TDFN-2x3-8L

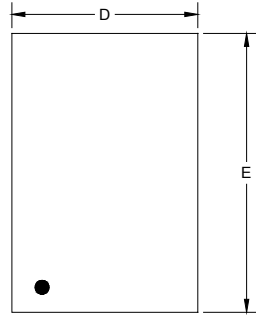

TOP VIEW

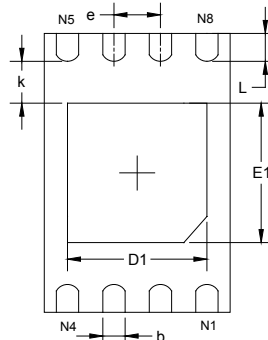

BOTTOM VIEW

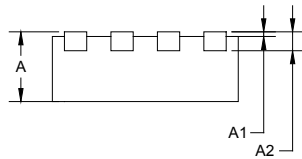

SIDE VIEW

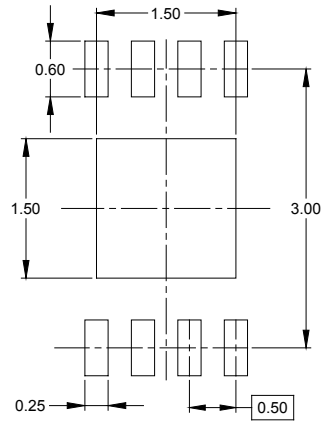

RECOMMENDED LAND PATTERN (Unit: mm)

Symbol	Dimensions In Millimeters		Dimensions In Inches	
	MIN	MAX	MIN	MAX
A	0.700	0.800	0.028	0.031
A1	0.000	0.050	0.000	0.002
A2	0.203 REF		0.008 REF	
D	1.924	2.076	0.076	0.082
D1	1.400	1.600	0.055	0.063
E	2.924	3.076	0.115	0.121
E1	1.400	1.600	0.055	0.063
k	0.200 MIN		0.008 MIN	
b	0.200	0.300	0.008	0.012
e	0.500 TYP		0.020 TYP	
L	0.224	0.376	0.009	0.015

# PACKAGE INFORMATION

## PACKAGE OUTLINE DIMENSIONS

### SOIC-14

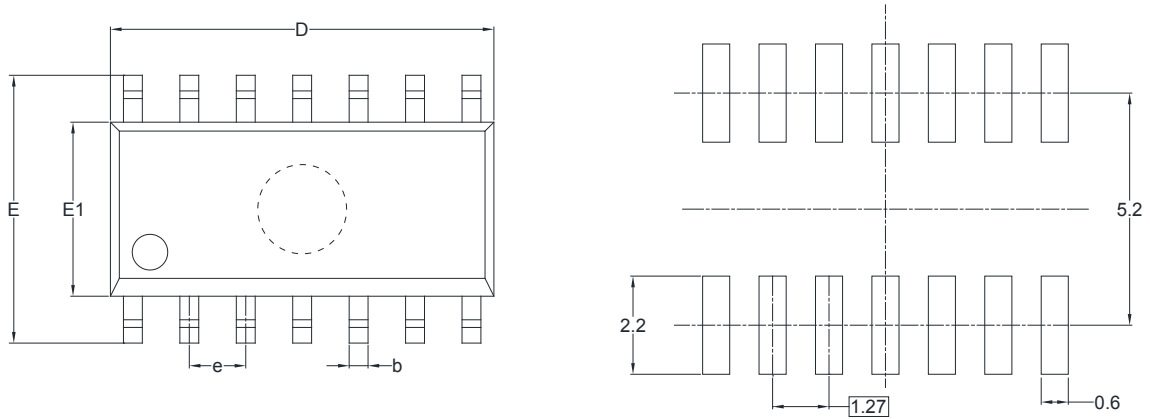

RECOMMENDED LAND PATTERN (Unit: mm)

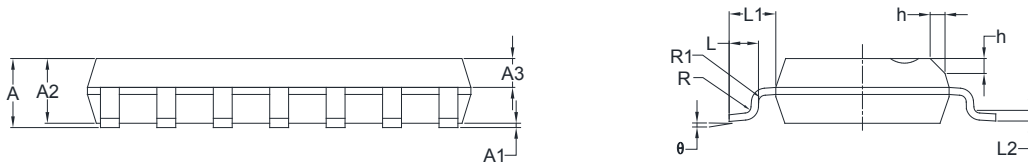

Symbol	Dimensions In Millimeters		Dimensions In Inches	
	MIN	MAX	MIN	MAX
A	1.35	1.75	0.053	0.069
A1	0.10	0.25	0.004	0.010
A2	1.25	1.65	0.049	0.065
A3	0.55	0.75	0.022	0.030
b	0.36	0.49	0.014	0.019
D	8.53	8.73	0.336	0.344
E	5.80	6.20	0.228	0.244
E1	3.80	4.00	0.150	0.157
e	1.27 BSC		0.050 BSC	
L	0.45	0.80	0.018	0.032
L1	1.04 REF		0.040 REF	
L2	0.25 BSC		0.01 BSC	
R	0.07		0.003	
R1	0.07		0.003	
h	0.30	0.50	0.012	0.020
θ	0°	8°	0°	8°

# PACKAGE INFORMATION

## TAPE AND REEL INFORMATION

### REEL DIMENSIONS

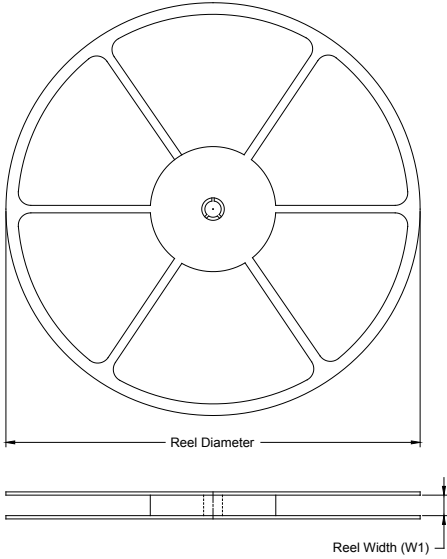

### TAPE DIMENSIONS

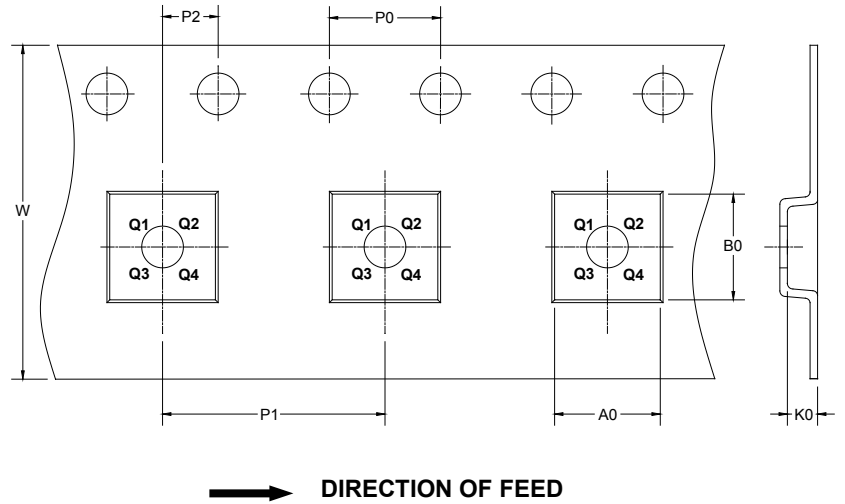

NOTE: The picture is only for reference. Please make the object as the standard.

### KEY PARAMETER LIST OF TAPE AND REEL

Package Type	Reel Diameter	Reel Width W1 (mm)	A0 (mm)	B0 (mm)	K0 (mm)	P0 (mm)	P1 (mm)	P2 (mm)	W (mm)	Pin1 Quadrant
SC70-5	7"	9.5	2.25	2.55	1.20	4.0	4.0	2.0	8.0	Q3
SOT-23-5	7"	9.5	3.20	3.20	1.40	4.0	4.0	2.0	8.0	Q3
SOIC-8	13"	12.4	6.40	5.40	2.10	4.0	8.0	2.0	12.0	Q1
MSOP-8	13"	12.4	5.20	3.30	1.50	4.0	8.0	2.0	12.0	Q1
TDFN-2×3-8L	7"	9.5	2.30	3.30	1.10	4.0	4.0	2.0	8.0	Q2
SOIC-14	13"	16.4	6.60	9.30	2.10	4.0	8.0	2.0	16.0	Q1

D00001



# PACKAGE INFORMATION

## CARTON BOX DIMENSIONS



NOTE: The picture is only for reference. Please make the object as the standard.

## KEY PARAMETER LIST OF CARTON BOX

Reel Type	Length (mm)	Width (mm)	Height (mm)	Pizza/Carton
7" (Option)	368	227	224	8
7"	442	410	224	18
13"	386	280	370	5

DD0002