



SGM8959-1/SGM8959-2

Low V_{OS} , Low Noise, High Precision Zero-Drift Operational Amplifiers

GENERAL DESCRIPTION

The single SGM8959-1 and dual SGM8959-2 are low power, high precision CMOS operational amplifiers, which can operate from 1.8V to 5.5V single supply or from $\pm 0.9V$ to $\pm 2.75V$ dual power supplies, while consuming only $380\mu A$ quiescent current per amplifier. The SGM8959-1/2 support rail-to-rail input and output operation. The input common mode voltage range is 100mV beyond the rails, and the output swings within 5mV of the rails.

The SGM8959-1/2 feature high impedance inputs, a $10\mu V$ maximum input offset voltage and zero-drift over time and temperature. These devices are designed to provide optimal performance in low voltage and low power systems. These specifications make the operational amplifiers appropriate for a wide range of applications requiring high precision, such as driving ADCs with high linearity.

The SGM8959-1 is available in Green SOT-23-5, SC70-5 and SOIC-8 packages. The SGM8959-2 is available in Green SOIC-8 and TDFN-3 \times 3-8L packages. They are specified over $-40^{\circ}C$ to $+125^{\circ}C$ temperature range.

FEATURES

- **Low Offset Voltage: $10\mu V$ (MAX)**
- **Low 0.1Hz to 10Hz Noise: $0.2\mu V_{P-P}$**
- **Input Voltage Noise: $8nV/\sqrt{Hz}$**
- **Integrated EMI Filter**
- **Gain-Bandwidth: 3.9MHz**
- **Slew Rate : $1.0V/\mu s$**
- **Rail-to-Rail Input and Output**
- **Support Single or Dual Power Supplies:
1.8V to 5.5V or $\pm 0.9V$ to $\pm 2.75V$**
- **Quiescent Current: $380\mu A$ /Amplifier (TYP)**
- **$-40^{\circ}C$ to $+125^{\circ}C$ Operating Temperature Range**
- **Small Packaging:
SGM8959-1 Available in Green SOT-23-5, SC70-5
and SOIC-8 Packages
SGM8959-2 Available in Green SOIC-8 and
TDFN-3 \times 3-8L Packages**

APPLICATIONS

Temperature Measurements
Medical Instrumentation
Transducer Applications
Electronic Scales
Handheld Test Equipment
Battery-Powered Instruments

PACKAGE/ORDERING INFORMATION

MODEL	PACKAGE DESCRIPTION	SPECIFIED TEMPERATURE RANGE	ORDERING NUMBER	PACKAGE MARKING	PACKING OPTION
SGM8959-1	SOT-23-5	-40°C to +125°C	SGM8959-1XN5G/TR	GD4XX	Tape and Reel, 3000
	SC70-5	-40°C to +125°C	SGM8959-1XC5G/TR	GCDXX	Tape and Reel, 3000
	SOIC-8	-40°C to +125°C	SGM8959-1XS8G/TR	SGM 89591XS8 XXXXX	Tape and Reel, 2500
SGM8959-2	SOIC-8	-40°C to +125°C	SGM8959-2XS8G/TR	SGM 89592XS8 XXXXX	Tape and Reel, 2500
	TDFN-3×3-8L	-40°C to +125°C	SGM8959-2XTDB8G/TR	SGM GD5DB XXXXX	Tape and Reel, 4000

MARKING INFORMATION

NOTE: XX = Date Code. XXXXX = Date Code and Vendor Code.

SOT-23-5/SC70-5

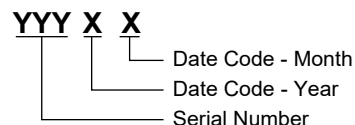

SOIC-8/TDFN-3×3-8L

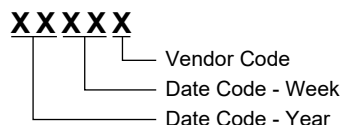

Green (RoHS & HSF): SG Micro Corp defines "Green" to mean Pb-Free (RoHS compatible) and free of halogen substances. If you have additional comments or questions, please contact your SGMICRO representative directly.

ABSOLUTE MAXIMUM RATINGS

- Supply Voltage.....6V
- Junction Temperature.....+150°C
- Storage Temperature Range-65°C to +150°C
- Lead Temperature (Soldering, 10s).....+260°C
- ESD Susceptibility
- HBM.....4000V
- MM.....400V
- CDM1000V

RECOMMENDED OPERATING CONDITIONS

- Specified Voltage Range1.8V to 5.5V
- Operating Temperature Range-40°C to +125°C

OVERSTRESS CAUTION

Stresses beyond those listed in Absolute Maximum Ratings may cause permanent damage to the device. Exposure to absolute maximum rating conditions for extended periods

may affect reliability. Functional operation of the device at any conditions beyond those indicated in the Recommended Operating Conditions section is not implied.

ESD SENSITIVITY CAUTION

This integrated circuit can be damaged if ESD protections are not considered carefully. SGMICRO recommends that all integrated circuits be handled with appropriate precautions. Failure to observe proper handling and installation procedures can cause damage. ESD damage can range from subtle performance degradation to complete device failure. Precision integrated circuits may be more susceptible to damage because even small parametric changes could cause the device not to meet the published specifications.

DISCLAIMER

SG Micro Corp reserves the right to make any change in circuit design, or specifications without prior notice.

PIN CONFIGURATIONS

SGM8959-1 (TOP VIEW)

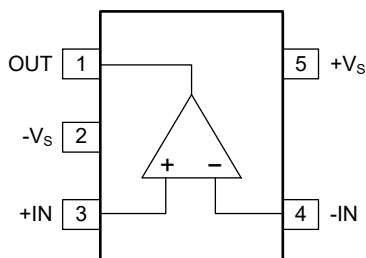

SOT-23-5

SGM8959-1 (TOP VIEW)

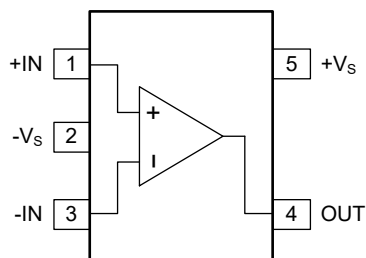

SC70-5

SGM8959-1 (TOP VIEW)

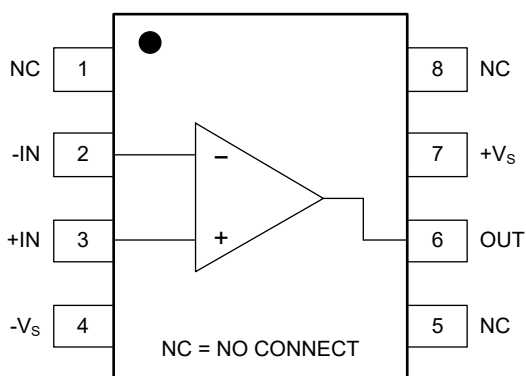

SOIC-8

SGM8959-2 (TOP VIEW)

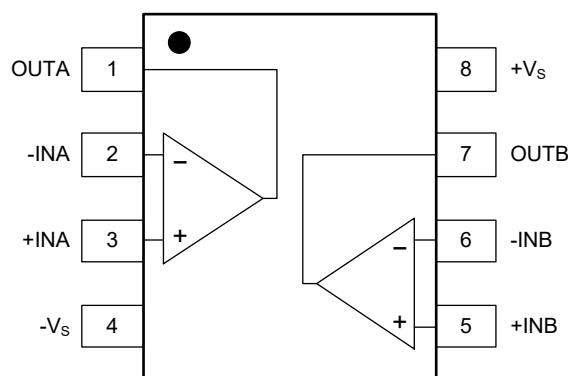

SOIC-8

SGM8959-2 (TOP VIEW)

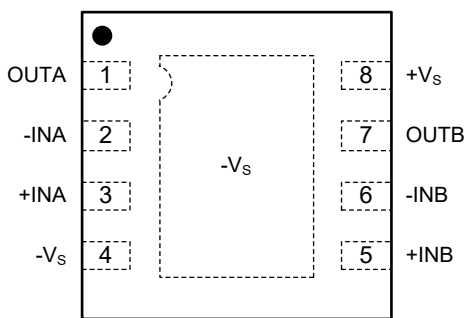

TDFN-3x3-8L

NOTE: For TDFN-3x3-8L package, exposed pad can be connected to $-V_s$ or left floating.

ELECTRICAL CHARACTERISTICS

($V_S = 5V$, $V_{CM} = V_S/2$, $V_{OUT} = V_S/2$, and $R_L = 10k\Omega$ to $V_S/2$, Full = $-40^\circ C$ to $+125^\circ C$, typical values are at $T_A = +25^\circ C$, unless otherwise noted.)

PARAMETER	SYMBOL	CONDITIONS	TEMP	MIN	TYP	MAX	UNITS
Input Characteristics							
Input Offset Voltage	V_{OS}	$V_S = 5V$	+25°C		2.5	10	μV
			Full			28	
Input Offset Voltage Drift	$\Delta V_{OS}/\Delta T$		Full		0.032		$\mu V/^\circ C$
Input Bias Current	I_B		+25°C		350		pA
Input Offset Current	I_{OS}		+25°C		700		pA
Input Common Mode Voltage Range	V_{CM}		+25°C	$(-V_S) - 0.1$		$(+V_S) + 0.1$	V
Common Mode Rejection Ratio	CMRR	$-V_S < V_{CM} < V_S$	+25°C	107	123		dB
			Full	105			
Open-Loop Voltage Gain	A_{OL}	$(-V_S) + 0.1V < V_{OUT} < (+V_S) - 0.1V$, $R_L = 10k\Omega$	+25°C	110	127		dB
Output Characteristics							
Output Voltage Swing from Rail		$R_L = 10k\Omega$	+25°C		5	10	mV
Short-Circuit Current	I_{SC}		+25°C	25	42		mA
Capacitive Load Drive			+25°C	See Typical Performance Characteristics			
Power Supply							
Specified Voltage Range	V_S		Full	1.8		5.5	V
Power Supply Rejection Ratio	PSRR	$V_S = 1.8V$ to $5.5V$, $V_{CM} = 0.2V$	+25°C		1	4	$\mu V/V$
			Full			5	
Quiescent Current/Amplifier	I_Q	$I_{OUT} = 0$	+25°C		380	560	μA
			Full			665	
Turn-On Time		$G = +1$, $V_{IN} = 0.1V$, $R_L = 10k\Omega$, $C_L = 30pF$	+25°C		33		μs
Dynamic Performance							
Gain-Bandwidth Product	GBP	$C_L = 30pF$	+25°C		4		MHz
Slew Rate	SR	$G = +1$, $V_{OUT} = 2V_{P-P}$, $C_L = 30pF$	+25°C		1		V/ μs
Noise							
Input Voltage Noise		$f = 0.1Hz$ to $10Hz$	+25°C		0.2		μV_{P-P}
Input Voltage Noise Density	e_n	$f = 1kHz$	+25°C		8		nV/\sqrt{Hz}

ELECTRICAL CHARACTERISTICS (continued)

($V_S = 1.8V$, $V_{CM} = V_S/2$, $V_{OUT} = V_S/2$, and $R_L = 10k\Omega$ to $V_S/2$, Full = $-40^\circ C$ to $+125^\circ C$, typical values are at $T_A = +25^\circ C$, unless otherwise noted.)

PARAMETER	SYMBOL	CONDITIONS	TEMP	MIN	TYP	MAX	UNITS
Input Characteristics							
Input Offset Voltage	V_{OS}	$V_S = 1.8V$	+25°C		3.0	10	μV
			Full			29	
Input Offset Voltage Drift	$\Delta V_{OS}/\Delta T$		Full		0.035		$\mu V/^\circ C$
Input Bias Current	I_B		+25°C		350		pA
Input Offset Current	I_{OS}		+25°C		700		pA
Input Common Mode Voltage Range	V_{CM}		+25°C	$(-V_S) - 0.1$		$(+V_S) + 0.1$	V
Common Mode Rejection Ratio	CMRR	$-V_S < V_{CM} < V_S$	+25°C	104	122		dB
			Full	69			
Open-Loop Voltage Gain	A_{OL}	$(-V_S) + 0.1V < V_{OUT} < (+V_S) - 0.1V$, $R_L = 10k\Omega$	+25°C	109	127		dB
Output Characteristics							
Output Voltage Swing from Rail		$R_L = 10k\Omega$	+25°C		3	6	mV
Short-Circuit Current	I_{SC}		+25°C	7.5	12		mA
Capacitive Load Drive			+25°C	See Typical Performance Characteristics			
Power Supply							
Specified Voltage Range	V_S		Full	1.8		5.5	V
Power Supply Rejection Ratio	PSRR	$V_S = 1.8V$ to $5.5V$, $V_{CM} = 0.2V$	+25°C		1	4	$\mu V/V$
			Full			5	
Quiescent Current/Amplifier	I_Q	$I_{OUT} = 0$	+25°C		560	780	μA
			Full			950	
Turn-On Time		$G = +1$, $V_{IN} = 0.1V$, $R_L = 10k\Omega$, $C_L = 30pF$	+25°C		63		μs
Dynamic Performance							
Gain-Bandwidth Product	GBP	$C_L = 30pF$	+25°C		3.5		MHz
Slew Rate	SR	$G = +1$, $V_{OUT} = 1V_{P-P}$, $C_L = 30pF$	+25°C		0.6		V/ μs
Noise							
Input Voltage Noise		$f = 0.1Hz$ to $10Hz$	+25°C		0.3		μV_{P-P}
Input Voltage Noise Density	e_n	$f = 1kHz$	+25°C		14		nV/\sqrt{Hz}

TYPICAL PERFORMANCE CHARACTERISTICS

At $T_A = +25^\circ\text{C}$, unless otherwise noted.

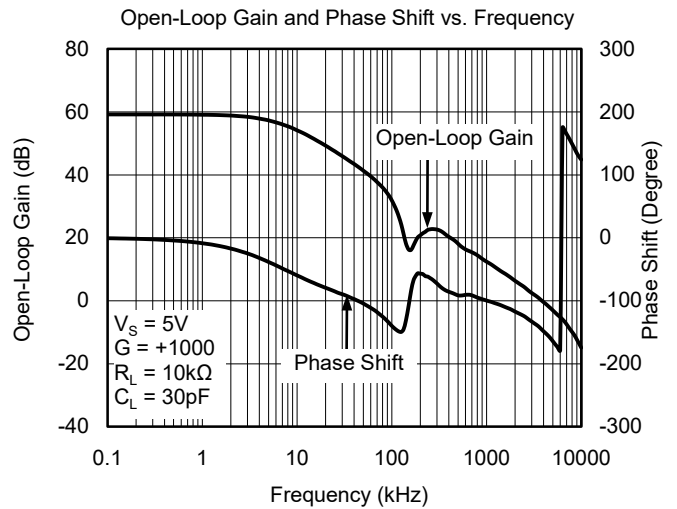
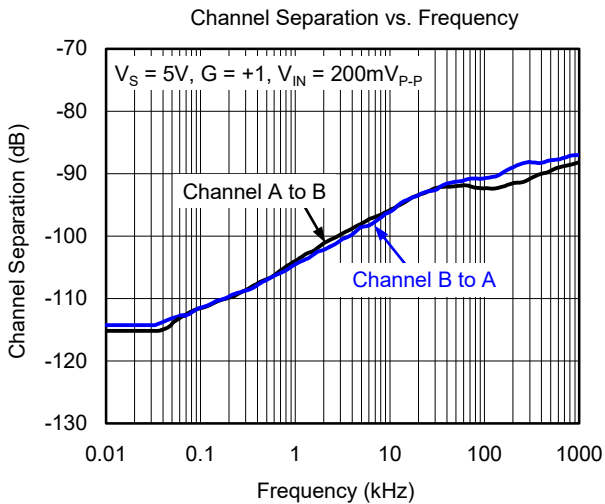
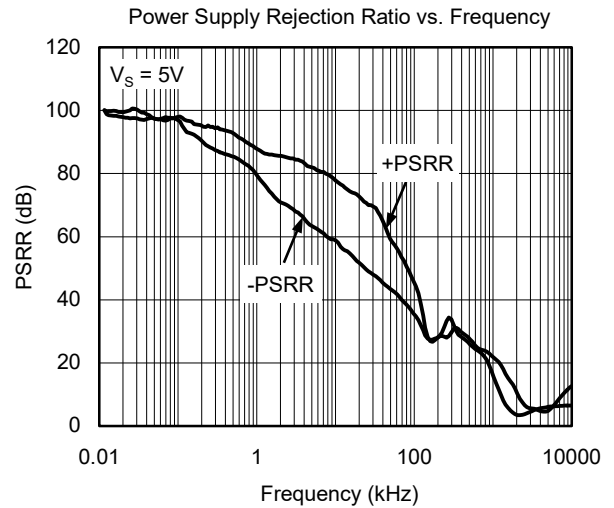
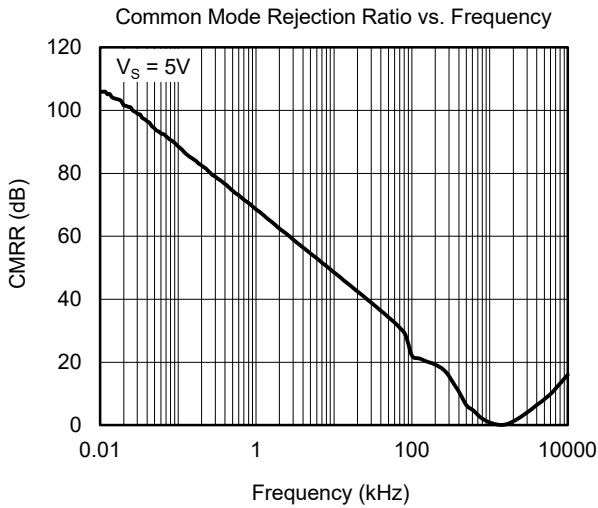
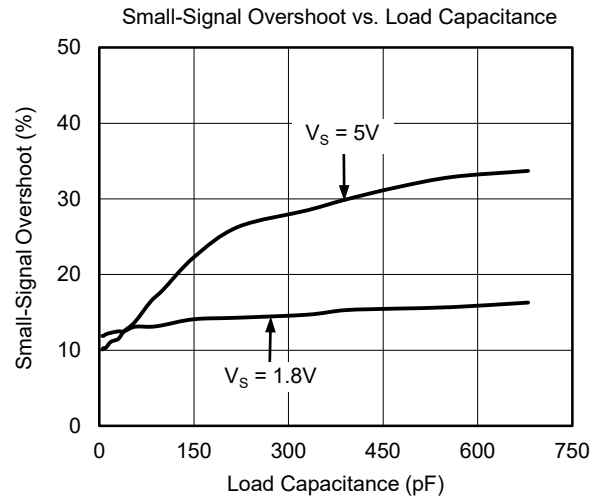
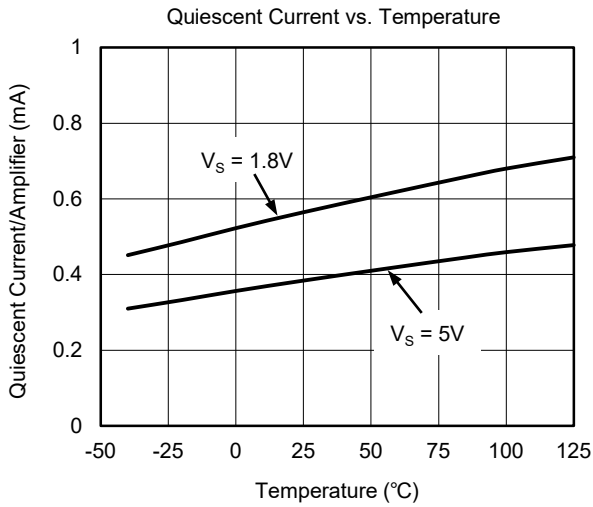

TYPICAL PERFORMANCE CHARACTERISTICS (continued)

At $T_A = +25^\circ\text{C}$, unless otherwise noted.

Large-Signal Step Response

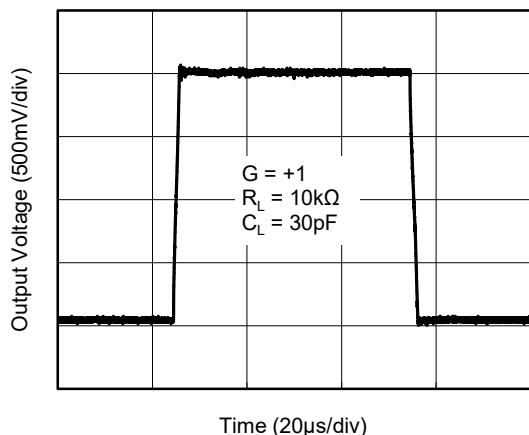

Small-Signal Step Response

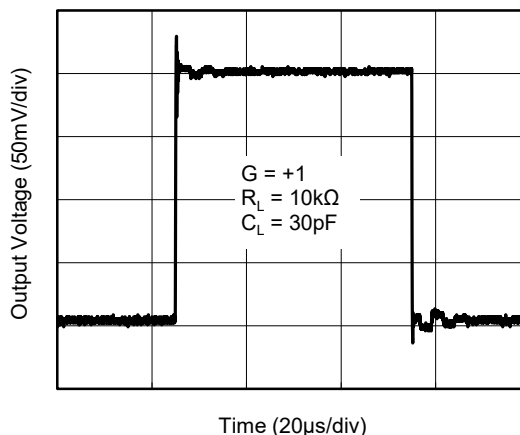

Positive Over-Voltage Recovery

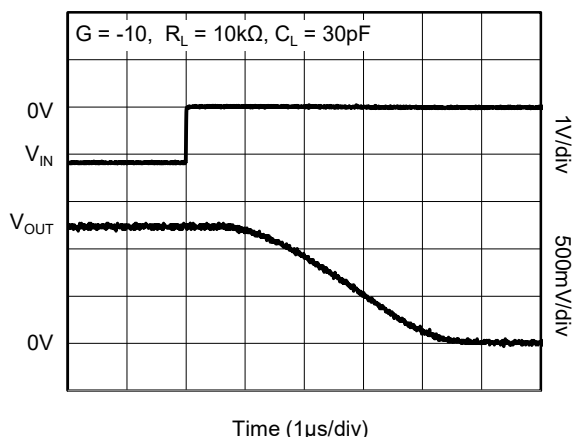

Negative Over-Voltage Recovery

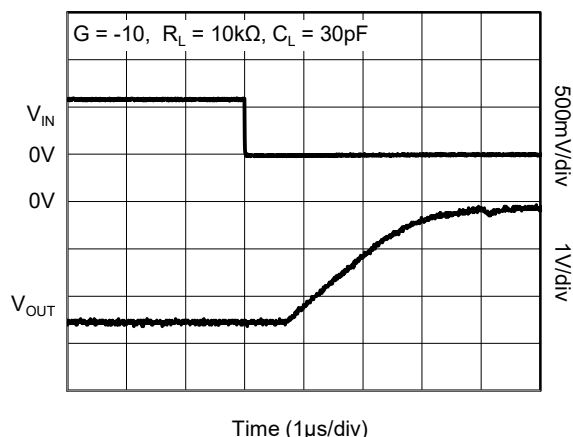

Turn-On Time

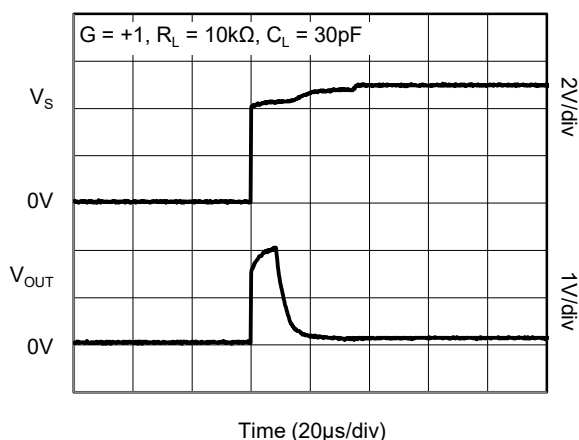

Settling Time vs. Closed-Loop Gain

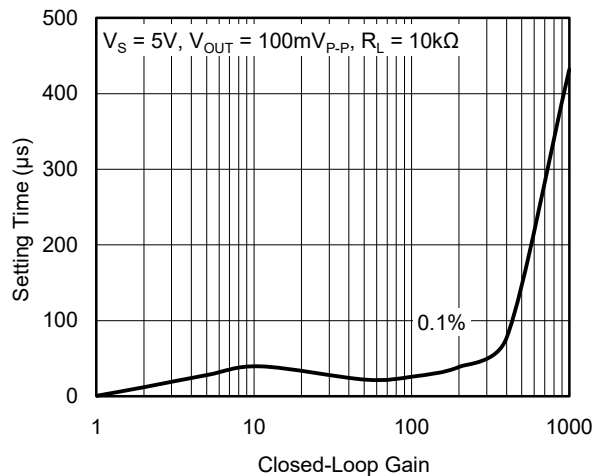

TYPICAL PERFORMANCE CHARACTERISTICS (continued)

At $T_A = +25^\circ\text{C}$, unless otherwise noted.

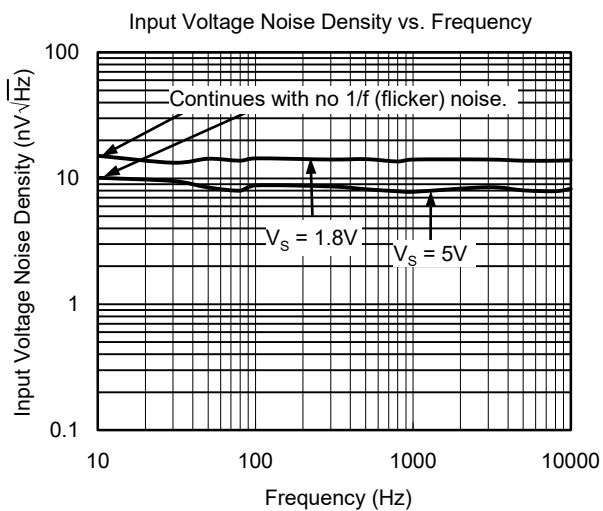
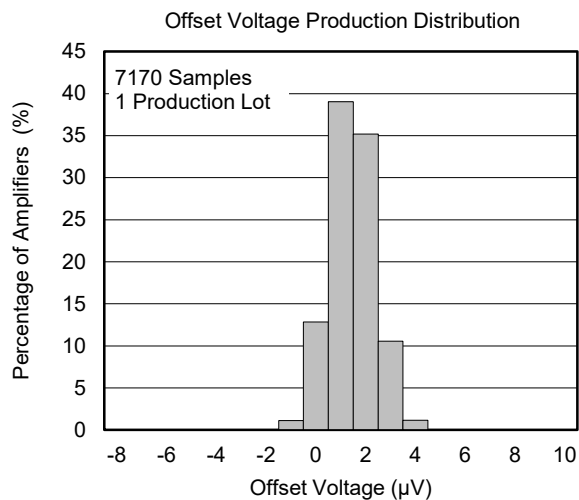
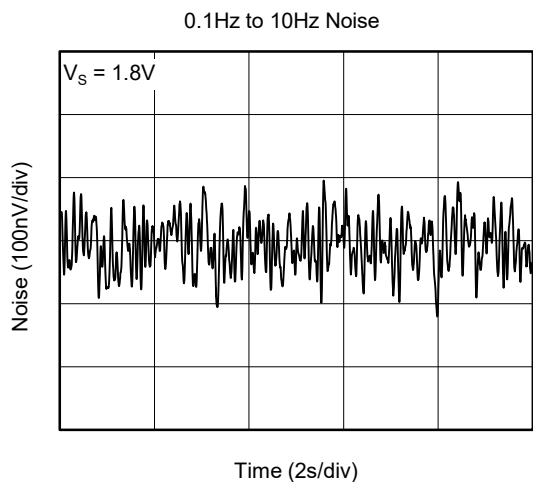

REVISION HISTORY

NOTE: Page numbers for previous revisions may differ from page numbers in the current version.

Changes from Original (DECEMBER 2016) to REV.A

Page

Changed from product preview to production data.....	All
--	-----

PACKAGE OUTLINE DIMENSIONS

SOT-23-5

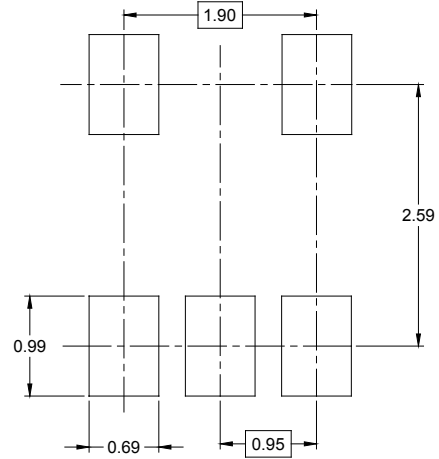

RECOMMENDED LAND PATTERN (Unit: mm)



Symbol	Dimensions In Millimeters		Dimensions In Inches	
	MIN	MAX	MIN	MAX
A	1.050	1.250	0.041	0.049
A1	0.000	0.100	0.000	0.004
A2	1.050	1.150	0.041	0.045
b	0.300	0.500	0.012	0.020
c	0.100	0.200	0.004	0.008
D	2.820	3.020	0.111	0.119
E	1.500	1.700	0.059	0.067
E1	2.650	2.950	0.104	0.116
e	0.950 BSC		0.037 BSC	
e1	1.900 BSC		0.075 BSC	
L	0.300	0.600	0.012	0.024
θ	0°	8°	0°	8°

PACKAGE OUTLINE DIMENSIONS

SC70-5

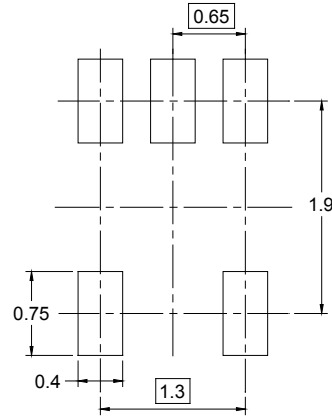
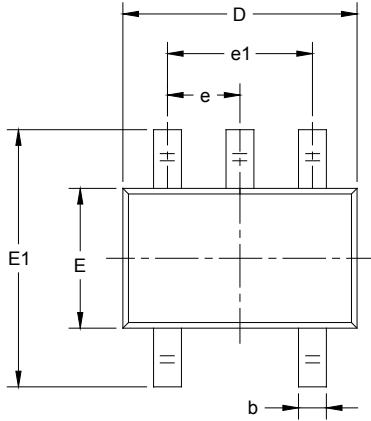

RECOMMENDED LAND PATTERN (Unit: mm)

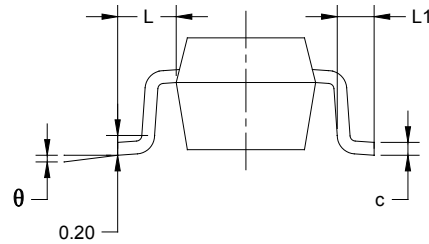
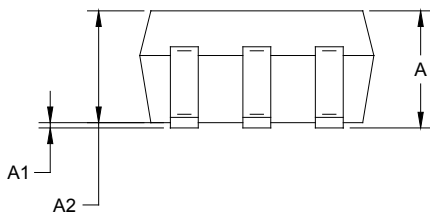

Symbol	Dimensions In Millimeters		Dimensions In Inches	
	MIN	MAX	MIN	MAX
A	0.900	1.100	0.035	0.043
A1	0.000	0.100	0.000	0.004
A2	0.900	1.000	0.035	0.039
b	0.150	0.350	0.006	0.014
c	0.080	0.150	0.003	0.006
D	2.000	2.200	0.079	0.087
E	1.150	1.350	0.045	0.053
E1	2.150	2.450	0.085	0.096
e	0.65 TYP		0.026 TYP	
e1	1.300 BSC		0.051 BSC	
L	0.525 REF		0.021 REF	
L1	0.260	0.460	0.010	0.018
θ	0°	8°	0°	8°

PACKAGE OUTLINE DIMENSIONS

SOIC-8

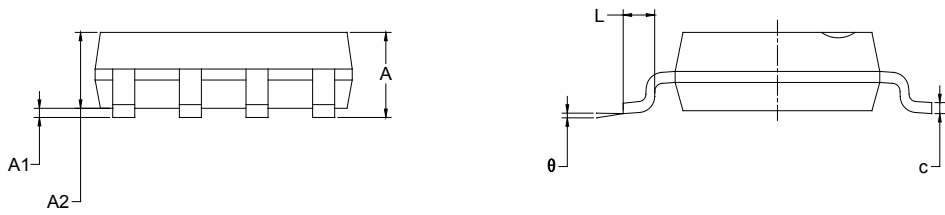
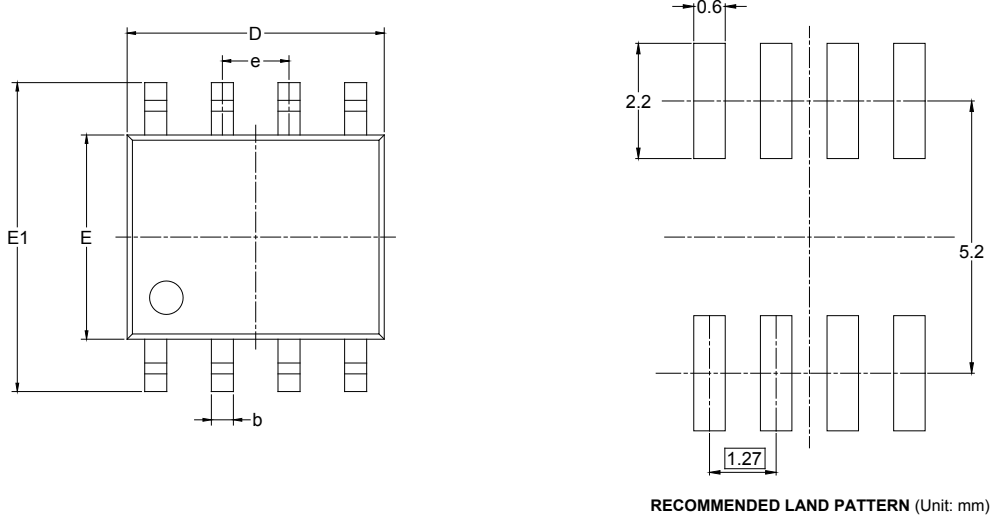

Symbol	Dimensions In Millimeters		Dimensions In Inches	
	MIN	MAX	MIN	MAX
A	1.350	1.750	0.053	0.069
A1	0.100	0.250	0.004	0.010
A2	1.350	1.550	0.053	0.061
b	0.330	0.510	0.013	0.020
c	0.170	0.250	0.006	0.010
D	4.700	5.100	0.185	0.200
E	3.800	4.000	0.150	0.157
E1	5.800	6.200	0.228	0.244
e	1.27 BSC		0.050 BSC	
L	0.400	1.270	0.016	0.050
θ	0°	8°	0°	8°

PACKAGE OUTLINE DIMENSIONS

TDFN-3x3-8L

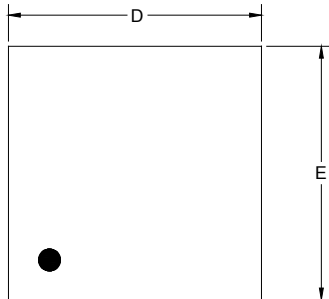

TOP VIEW

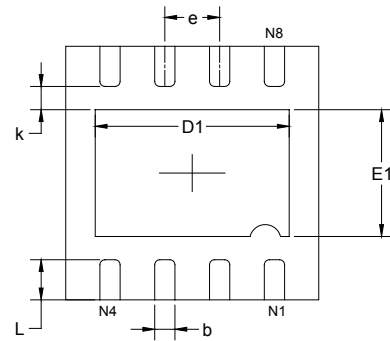

BOTTOM VIEW

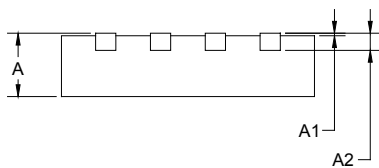

SIDE VIEW

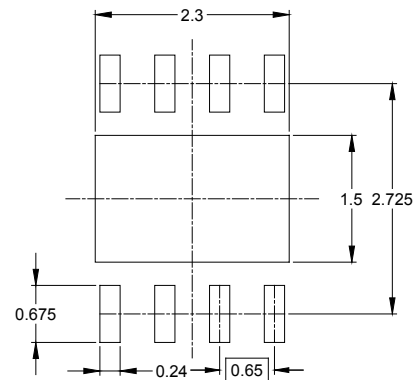

RECOMMENDED LAND PATTERN (Unit: mm)

Symbol	Dimensions In Millimeters		Dimensions In Inches	
	MIN	MAX	MIN	MAX
A	0.700	0.800	0.028	0.031
A1	0.000	0.050	0.000	0.002
A2	0.203 REF		0.008 REF	
D	2.900	3.100	0.114	0.122
D1	2.200	2.400	0.087	0.094
E	2.900	3.100	0.114	0.122
E1	1.400	1.600	0.055	0.063
k	0.200 MIN		0.008 MIN	
b	0.180	0.300	0.007	0.012
e	0.650 TYP		0.026 TYP	
L	0.375	0.575	0.015	0.023

PACKAGE INFORMATION

TAPE AND REEL INFORMATION

REEL DIMENSIONS



TAPE DIMENSIONS



NOTE: The picture is only for reference. Please make the object as the standard.

KEY PARAMETER LIST OF TAPE AND REEL

Package Type	Reel Diameter	Reel Width W1 (mm)	A0 (mm)	B0 (mm)	K0 (mm)	P0 (mm)	P1 (mm)	P2 (mm)	W (mm)	Pin1 Quadrant
SOT-23-5	7"	9.5	3.20	3.20	1.40	4.0	4.0	2.0	8.0	Q3
SC70-5	7"	9.5	2.25	2.55	1.20	4.0	4.0	2.0	8.0	Q3
SOIC-8	13"	12.4	6.40	5.40	2.10	4.0	8.0	2.0	12.0	Q1
TDFN-3×3-8L	13"	12.4	3.35	3.35	1.13	4.0	8.0	2.0	12.0	Q1

D00001

PACKAGE INFORMATION

CARTON BOX DIMENSIONS



NOTE: The picture is only for reference. Please make the object as the standard.

KEY PARAMETER LIST OF CARTON BOX

Reel Type	Length (mm)	Width (mm)	Height (mm)	Pizza/Carton
7" (Option)	368	227	224	8
7"	442	410	224	18
13"	386	280	370	5

DD0002