



# SGM8631/SGM8632/SGM8633 6MHz, Rail-to-Rail I/O CMOS Operational Amplifiers

## GENERAL DESCRIPTION

The SGM8631/2/3 are a family of single and dual operational amplifiers, which are optimized for low voltage, low noise and low power operation. These devices can operate from 2V to 5.5V single supply, while consuming low quiescent current. The supply current of SGM8633 is less than 1 $\mu$ A in power-down mode.

The SGM8631/2/3 feature a 3.5mV maximum input offset voltage. The minimum input common mode voltage is within 0.1V below the negative rail, and the output swing is rail-to-rail with heavy loads. They exhibit a high gain-bandwidth product of 6MHz and a slew rate of 3.7V/ $\mu$ s. These specifications make the operational amplifiers appropriate for various applications.

The SGM8631 is available in Green SC70-5, SOT-23-5 and SOIC-8 packages. The SGM8632 is available in Green SOIC-8 and MSOP-8 packages. The SGM8633 is available in Green SOT-23-6 and SOIC-8 packages. They are specified over the extended industrial temperature range (-40°C to +125°C).

## FEATURES

- **Input Offset Voltage: 3.5mV (MAX)**
- **High Gain-Bandwidth Product: 6MHz**
- **High Slew Rate: 3.7V/ $\mu$ s**
- **Settling Time to 0.1% with 2V Step: 0.5 $\mu$ s**
- **Overload Recovery Time: 0.9 $\mu$ s**
- **Low Noise: 13nV/ $\sqrt{\text{Hz}}$  at 1kHz**
- **Rail-to-Rail Input and Output**
- **Supply Voltage Range: 2V to 5.5V**
- **Input Voltage Range: -0.1V to 5.6V with  $V_S = 5.5V$**
- **Low Supply Current:**
  - **SGM8631/3: 570 $\mu$ A (TYP)**
  - **SGM8632: 480 $\mu$ A/Amplifier (TYP)**
  - **SGM8633 Less than 1 $\mu$ A when Disabled**
- **-40°C to +125°C Operating Temperature Range**
- **Small Packaging:**
  - **SGM8631 Available in Green SC70-5, SOT-23-5 and SOIC-8 Packages**
  - **SGM8632 Available in Green MSOP-8 and SOIC-8 Packages**
  - **SGM8633 Available in Green SOT-23-6 and SOIC-8 Packages**

## APPLICATIONS

Sensors  
Audio  
Active Filters  
A/D Converters  
Communications  
Test Equipment  
Cellular and Cordless Phones  
Laptops and PDAs  
Photodiode Amplification  
Battery-Powered Instrumentation

**PACKAGE/ORDERING INFORMATION**

MODEL	PACKAGE DESCRIPTION	SPECIFIED TEMPERATURE RANGE	ORDERING NUMBER	PACKAGE MARKING	PACKING OPTION
SGM8631	SC70-5	-40°C to +125°C	SGM8631XC5/TR	8631	Tape and Reel, 3000
	SOT-23-5	-40°C to +125°C	SGM8631XN5/TR	8631	Tape and Reel, 3000
	SOIC-8	-40°C to +125°C	SGM8631XS/TR	SGM8631XS XXXXX	Tape and Reel, 2500
SGM8632	MSOP-8	-40°C to +125°C	SGM8632XMS/TR	SGM8632 XMS XXXXX	Tape and Reel, 3000
	SOIC-8	-40°C to +125°C	SGM8632XS/TR	SGM8632XS XXXXX	Tape and Reel, 2500
SGM8633	SOT-23-6	-40°C to +125°C	SGM8633XN6/TR	8633	Tape and Reel, 3000
	SOIC-8	-40°C to +125°C	SGM8633XS/TR	SGM8633XS XXXXX	Tape and Reel, 2500

**MARKING INFORMATION**

NOTE: XXXXX = Date Code and Vendor Code.

**SOIC-8/MSOP-8**

**XXXXX**

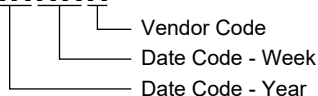

Green (RoHS & HSF): SG Micro Corp defines "Green" to mean Pb-Free (RoHS compatible) and free of halogen substances. If you have additional comments or questions, please contact your SGMICRO representative directly.

**ABSOLUTE MAXIMUM RATINGS**

- Supply Voltage, +V<sub>S</sub> to -V<sub>S</sub> ..... 6V
- Input Common Mode Voltage Range  
..... (-V<sub>S</sub>) - 0.3V to (+V<sub>S</sub>) + 0.3V
- Package Thermal Resistance @ T<sub>A</sub> = +25°C
- SC70-5, θ<sub>JA</sub>..... 333°C/W
- SOT-23-5, θ<sub>JA</sub>..... 190°C/W
- SOT-23-6, θ<sub>JA</sub>..... 190°C/W
- SOIC-8, θ<sub>JA</sub>..... 125°C/W
- MSOP-8, θ<sub>JA</sub>..... 216°C/W
- Junction Temperature..... +150°C
- Storage Temperature Range ..... -65°C to +150°C
- Lead Temperature (Soldering, 10s)..... +260°C
- ESD Susceptibility
- HBM (SGM8631/2) ..... 8000V
- HBM (SGM8633) ..... 4000V
- MM..... 400V
- CDM ..... 1000V

**RECOMMENDED OPERATING CONDITIONS**

Operating Temperature Range ..... -40°C to +125°C

**OVERSTRESS CAUTION**

Stresses beyond those listed in Absolute Maximum Ratings may cause permanent damage to the device. Exposure to absolute maximum rating conditions for extended periods may affect reliability. Functional operation of the device at any conditions beyond those indicated in the Recommended Operating Conditions section is not implied.

**ESD SENSITIVITY CAUTION**

This integrated circuit can be damaged if ESD protections are not considered carefully. SGMICRO recommends that all integrated circuits be handled with appropriate precautions. Failure to observe proper handling and installation procedures can cause damage. ESD damage can range from subtle performance degradation to complete device failure. Precision integrated circuits may be more susceptible to damage because even small parametric changes could cause the device not to meet the published specifications.

**DISCLAIMER**

SG Micro Corp reserves the right to make any change in circuit design, or specifications without prior notice.

**PIN CONFIGURATIONS**

**SGM8631 (TOP VIEW)**

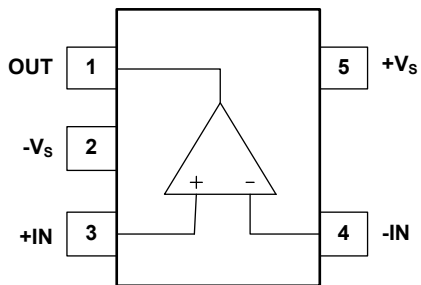

**SC70-5/SOT-23-5**

**SGM8631/8633 (TOP VIEW)**

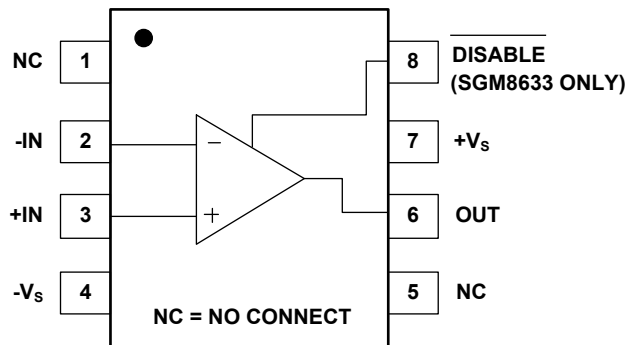

**SOIC-8**

**SGM8633 (TOP VIEW)**

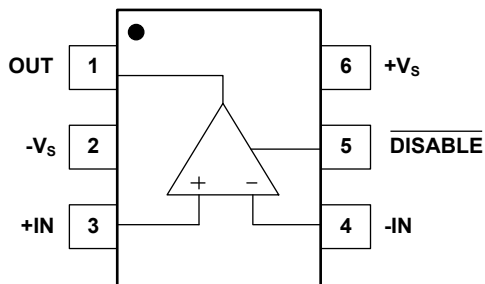

**SOT-23-6**

**SGM8632 (TOP VIEW)**

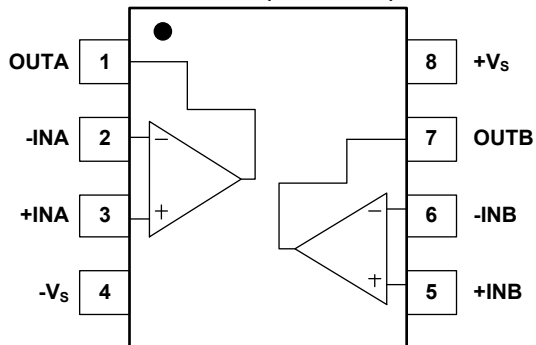

**SOIC-8/MSOP-8**

**ELECTRICAL CHARACTERISTICS**

(At T<sub>A</sub> = +25°C, V<sub>S</sub> = 5V, V<sub>CM</sub> = V<sub>S</sub>/2, R<sub>L</sub> = 600Ω, unless otherwise noted.)

PARAMETER	CONDITIONS	SGM8631/2/3						
		TYP	MIN/MAX OVER TEMPERATURE				UNITS	MIN/MAX
		+25°C	+25°C	-40°C to +85°C	-40°C to +125°C			
<b>Input Characteristics</b>								
Input Offset Voltage (V <sub>OS</sub> )		0.9	3.5	3.7	3.8	mV	MAX	
Input Bias Current (I <sub>B</sub> )		1				pA	TYP	
Input Offset Current (I <sub>OS</sub> )		1				pA	TYP	
Input Common Mode Voltage Range (V <sub>CM</sub> )	V <sub>S</sub> = 5.5V	-0.1 to 5.6				V	TYP	
Common Mode Rejection Ratio (CMRR)	V <sub>S</sub> = 5.5V, V <sub>CM</sub> = -0.1V to 4V	84	68	67	66	dB	MIN	
	V <sub>S</sub> = 5.5V, V <sub>CM</sub> = -0.1V to 5.6V	76				dB	MIN	
Open-Loop Voltage Gain (A <sub>OL</sub> )	R <sub>L</sub> = 600Ω, V <sub>OUT</sub> = 0.15V to 4.85V	86	79	73	69	dB	MIN	
	R <sub>L</sub> = 10kΩ, V <sub>OUT</sub> = 0.05V to 4.95V	103				dB	MIN	
Input Offset Voltage Drift (ΔV <sub>OS</sub> /ΔT)		2.4				μV/°C	TYP	
<b>Output Characteristics</b>								
Output Voltage Swing from Rail	R <sub>L</sub> = 600Ω	0.079				V	TYP	
	R <sub>L</sub> = 10kΩ	0.007				V	TYP	
Output Current (I <sub>OUT</sub> )		58	40	30	26	mA	MIN	
Closed-Loop Output Impedance	f = 200kHz, G = 1	5.4				Ω	TYP	
<b>Power-Down Disable (SGM8633 Only)</b>								
Turn-On Time		1.3				μs	TYP	
Turn-Off Time		0.4				μs	TYP	
DISABLE Voltage-Off			0.8			V	MAX	
DISABLE Voltage-On			2			V	MIN	
<b>Power Supply</b>								
Operating Voltage Range		2	2	2	2	V	MIN	
		5.5	5.5	5.5	5.5	V	MAX	
Power Supply Rejection Ratio (PSRR)	V <sub>S</sub> = 2V to 5.5V, V <sub>CM</sub> = (-V <sub>S</sub> ) + 0.5V	84	69	68	67	dB	MIN	
Quiescent Current/ Amplifier (I <sub>Q</sub> )	SGM8632 I <sub>OUT</sub> = 0	480	620	720	790	μA	MAX	
	SGM8631/3 I <sub>OUT</sub> = 0	570	720	820	880	μA	MAX	
Supply Current when Disabled (SGM8633 only)		0.5	8	9	10	μA	MAX	
<b>Dynamic Performance</b>								
Gain-Bandwidth Product (GBP)		6				MHz	TYP	
Phase Margin (φ <sub>0</sub> )		63				°	TYP	
Full Power Bandwidth (BW <sub>p</sub> )	< 1% distortion	250				kHz	TYP	
Slew Rate (SR)	G = 1, 2V output step	3.7				V/μs	TYP	
Settling Time to 0.1% (t <sub>s</sub> )	G = 1, 2V output step	0.5				μs	TYP	
Overload Recovery Time	V <sub>IN</sub> × G = V <sub>S</sub>	0.9				μs	TYP	
<b>Noise Performance</b>								
Input Voltage Noise Density (e <sub>n</sub> )	f = 1kHz	13				nV/√Hz	TYP	

**TYPICAL PERFORMANCE CHARACTERISTICS**

At  $T_A = +25^\circ\text{C}$ ,  $V_{CM} = V_S/2$ ,  $R_L = 600\Omega$ , unless otherwise noted.

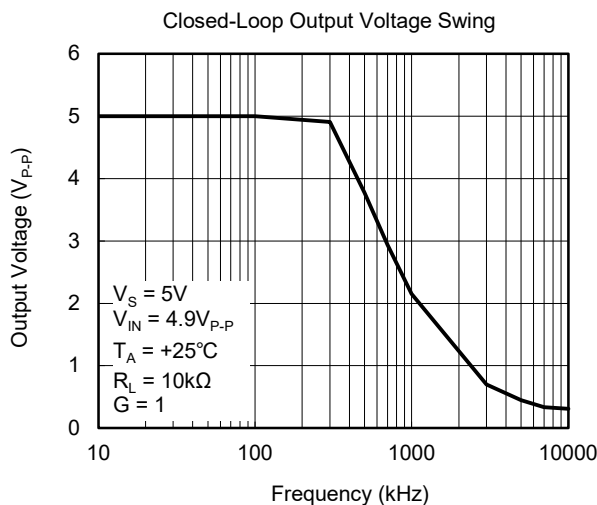
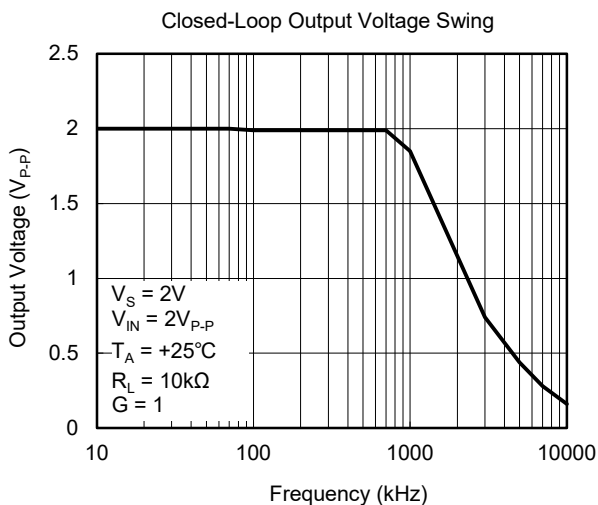
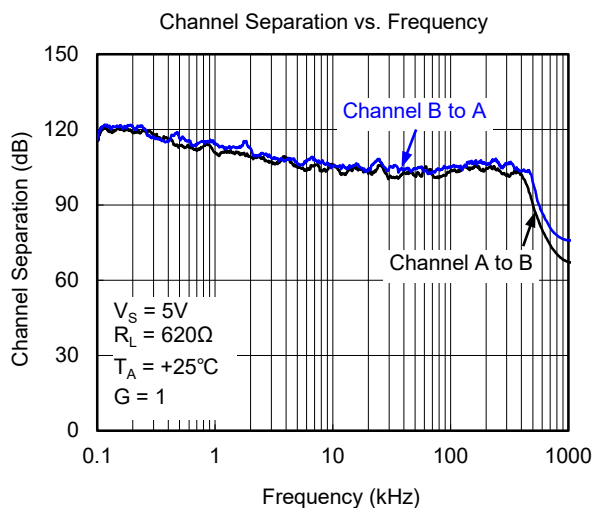
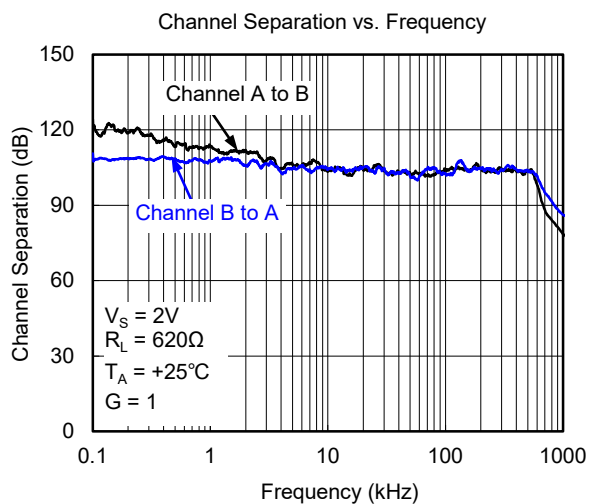
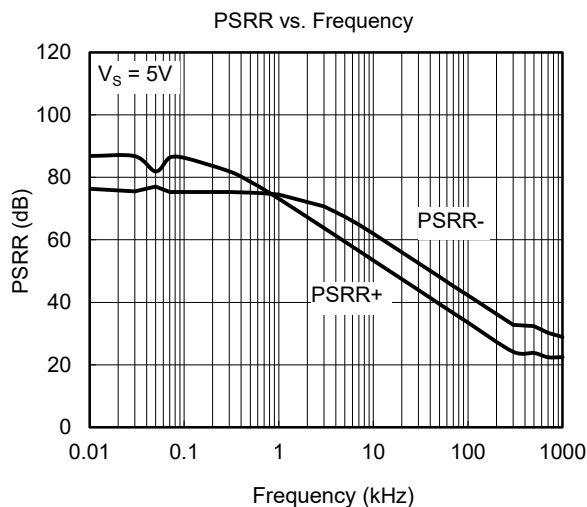
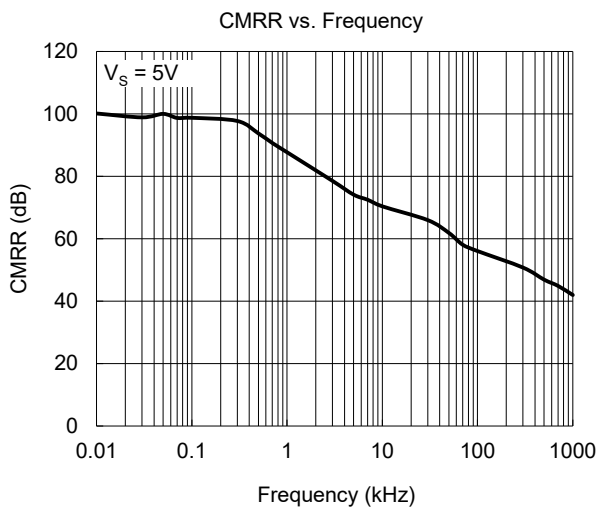

**TYPICAL PERFORMANCE CHARACTERISTICS (continued)**

At  $T_A = +25^\circ\text{C}$ ,  $V_{CM} = V_S/2$ ,  $R_L = 600\Omega$ , unless otherwise noted.

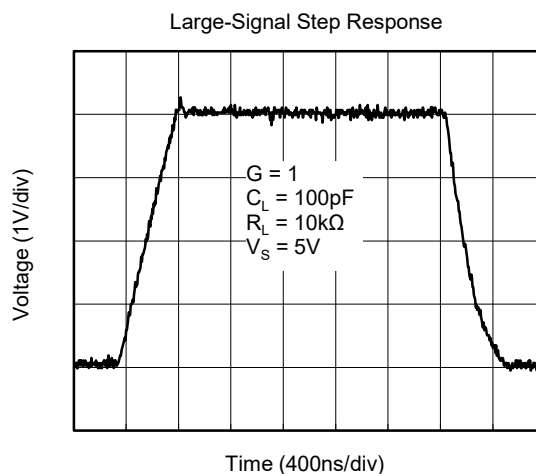
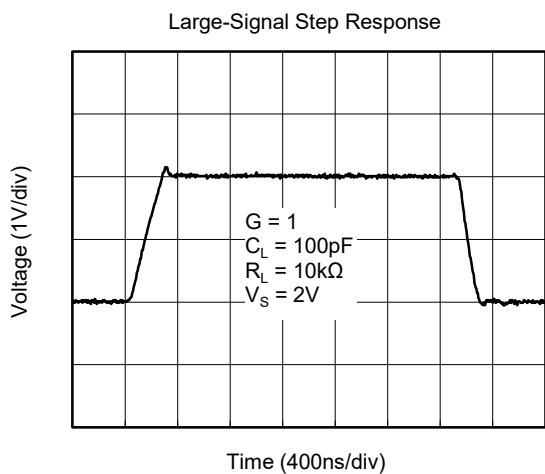
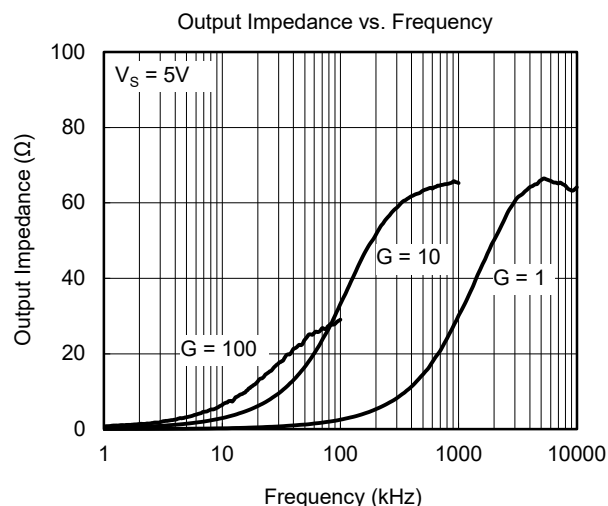
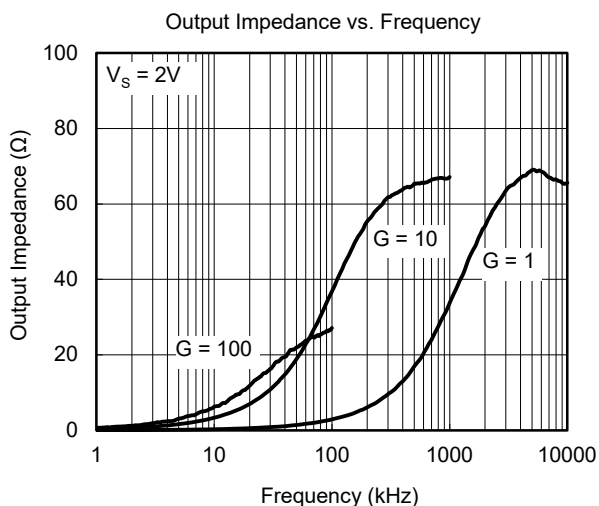
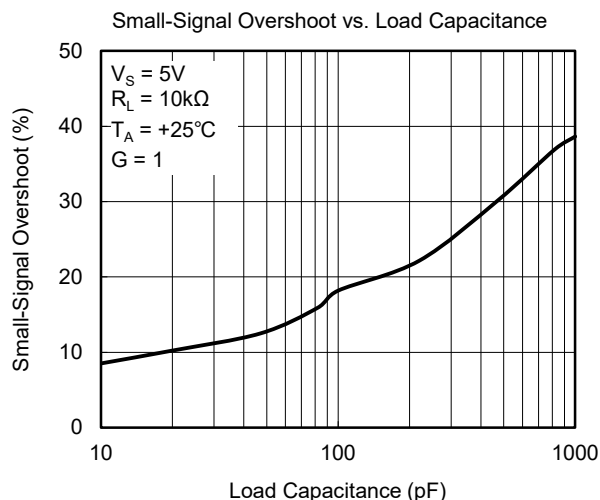
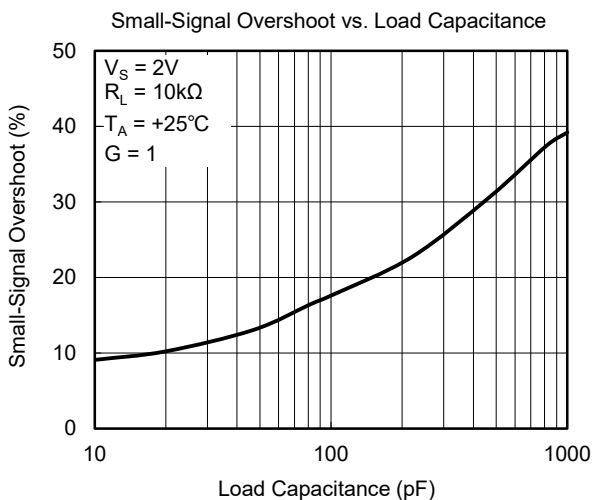

**TYPICAL PERFORMANCE CHARACTERISTICS (continued)**

At  $T_A = +25^\circ\text{C}$ ,  $V_{CM} = V_S/2$ ,  $R_L = 600\Omega$ , unless otherwise noted.

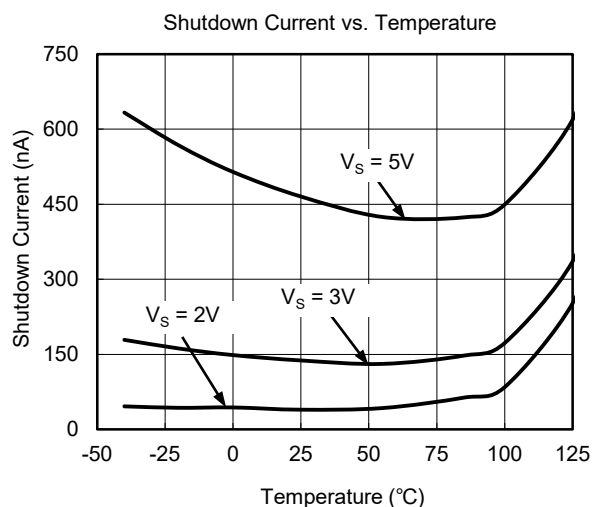
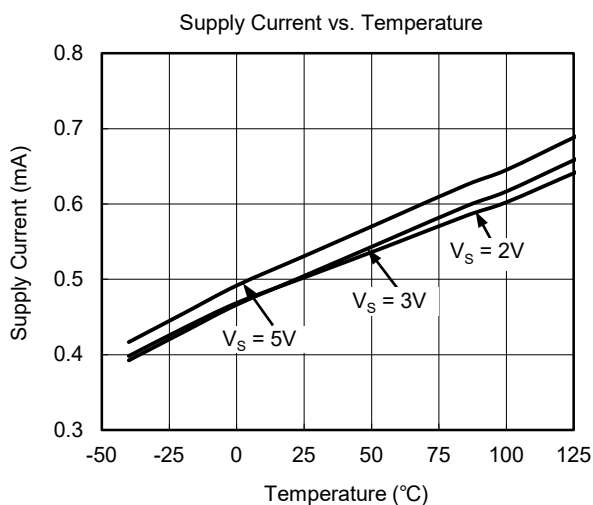
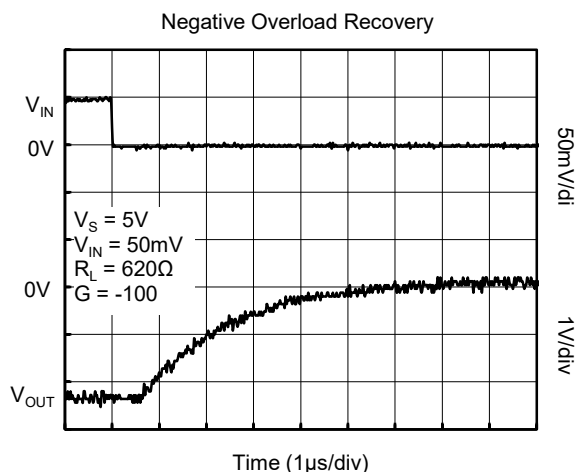
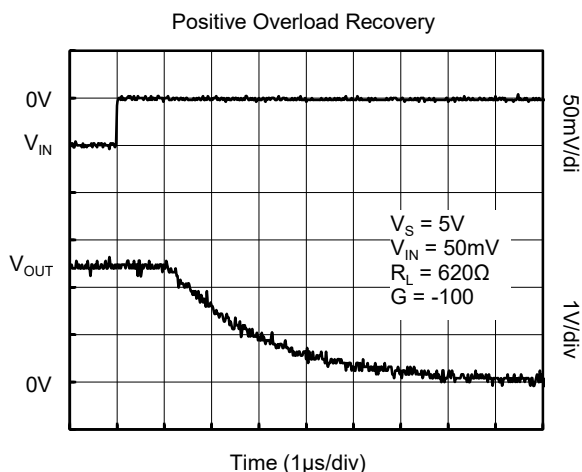
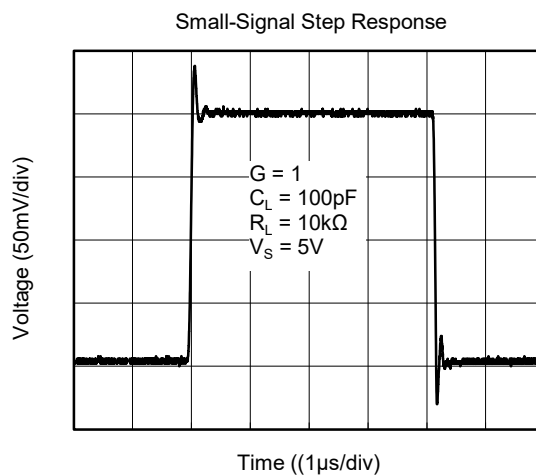
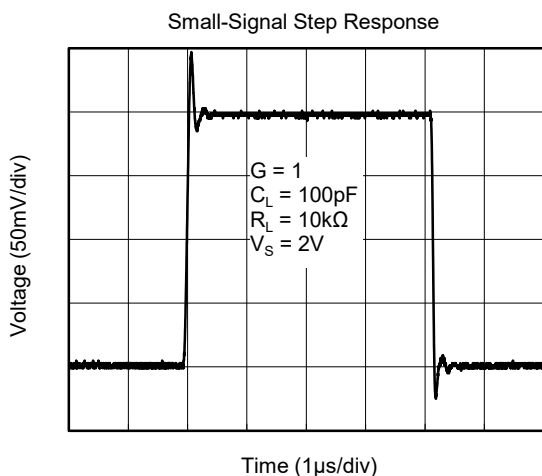

**TYPICAL PERFORMANCE CHARACTERISTICS (continued)**

At  $T_A = +25^\circ\text{C}$ ,  $V_{CM} = V_S/2$ ,  $R_L = 600\Omega$ , unless otherwise noted.

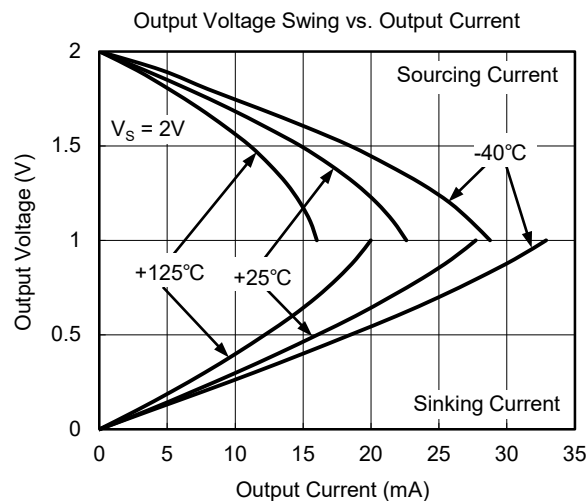
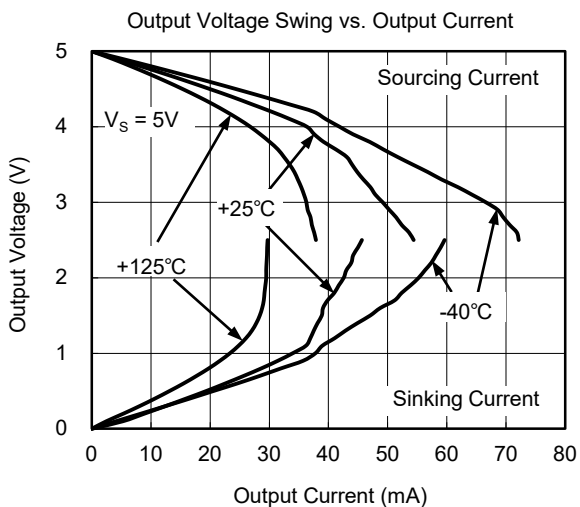
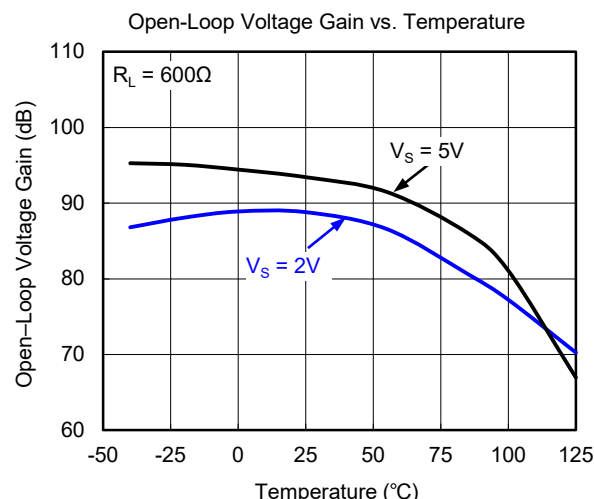
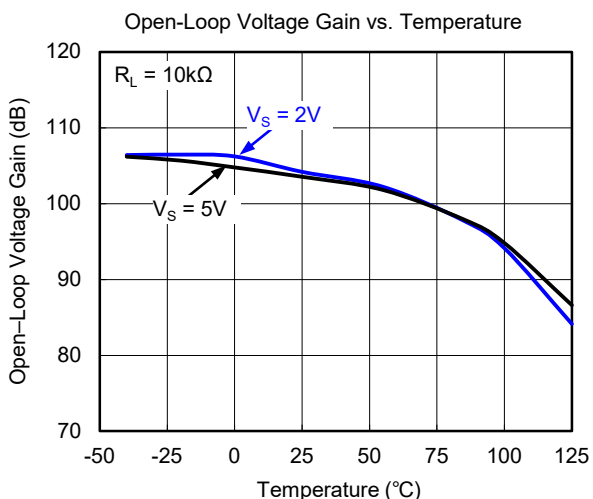
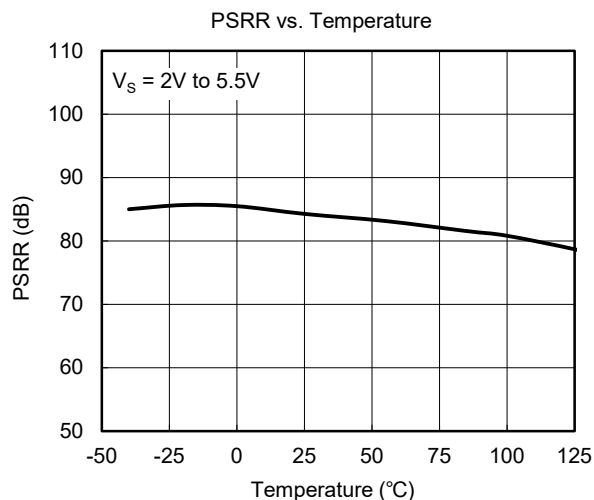
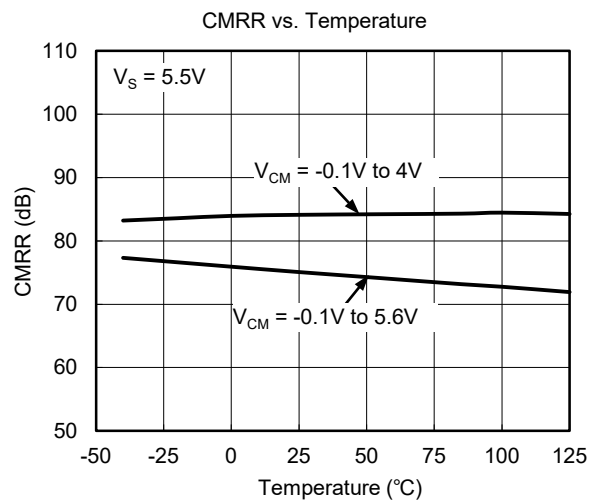



**TYPICAL PERFORMANCE CHARACTERISTICS (continued)**

At  $T_A = +25^\circ\text{C}$ ,  $V_{CM} = V_S/2$ ,  $R_L = 600\Omega$ , unless otherwise noted.

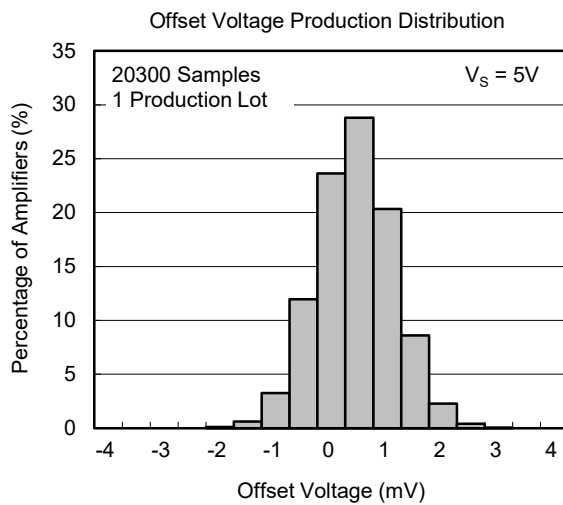
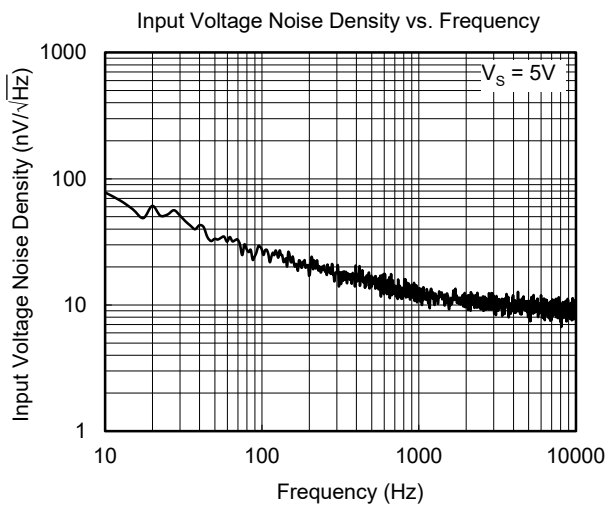

## REVISION HISTORY

NOTE: Page numbers for previous revisions may differ from page numbers in the current version.

<b>JULY 2016 – REV.C.2 to REV.C.3</b>	<b>Page</b>
Changed Electrical Characteristics section .....	4

---

<b>AUGUST 2015 – REV.C.1 to REV.C.2</b>	<b>Page</b>
New version.....	All

---

<b>February 2015 – REV.C to REV.C.1</b>	<b>Page</b>
Changed Package Outline Dimensions section .....	17, 18

---

PACKAGE OUTLINE DIMENSIONS

SC70-5

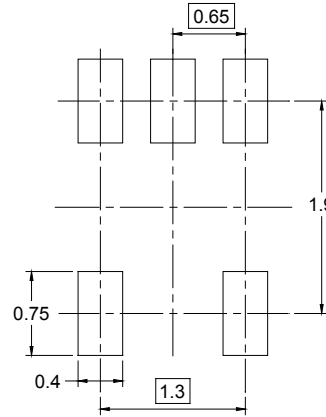
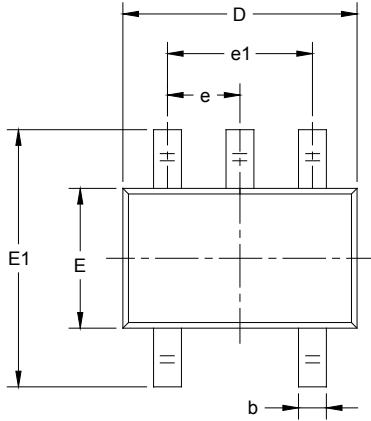

RECOMMENDED LAND PATTERN (Unit: mm)

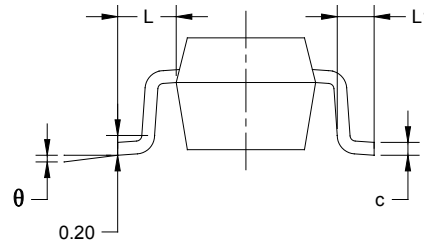
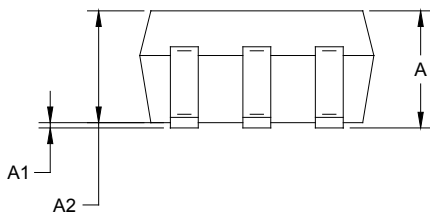

Symbol	Dimensions In Millimeters		Dimensions In Inches	
	MIN	MAX	MIN	MAX
A	0.900	1.100	0.035	0.043
A1	0.000	0.100	0.000	0.004
A2	0.900	1.000	0.035	0.039
b	0.150	0.350	0.006	0.014
c	0.080	0.150	0.003	0.006
D	2.000	2.200	0.079	0.087
E	1.150	1.350	0.045	0.053
E1	2.150	2.450	0.085	0.096
e	0.65 TYP		0.026 TYP	
e1	1.300 BSC		0.051 BSC	
L	0.525 REF		0.021 REF	
L1	0.260	0.460	0.010	0.018
$\theta$	0°	8°	0°	8°

PACKAGE OUTLINE DIMENSIONS

SOT-23-5

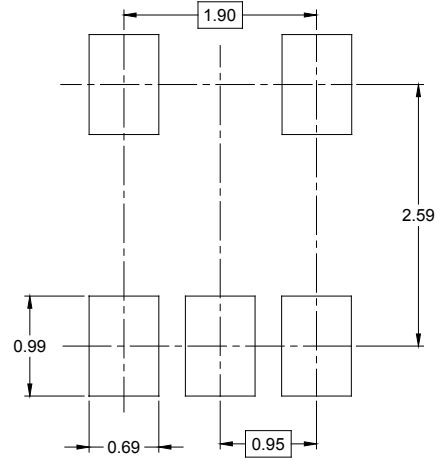

RECOMMENDED LAND PATTERN (Unit: mm)



Symbol	Dimensions In Millimeters		Dimensions In Inches	
	MIN	MAX	MIN	MAX
A	1.050	1.250	0.041	0.049
A1	0.000	0.100	0.000	0.004
A2	1.050	1.150	0.041	0.045
b	0.300	0.500	0.012	0.020
c	0.100	0.200	0.004	0.008
D	2.820	3.020	0.111	0.119
E	1.500	1.700	0.059	0.067
E1	2.650	2.950	0.104	0.116
e	0.950 BSC		0.037 BSC	
e1	1.900 BSC		0.075 BSC	
L	0.300	0.600	0.012	0.024
$\theta$	0°	8°	0°	8°

PACKAGE OUTLINE DIMENSIONS

SOT-23-6

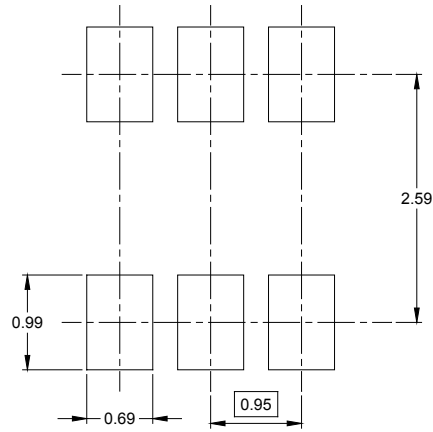
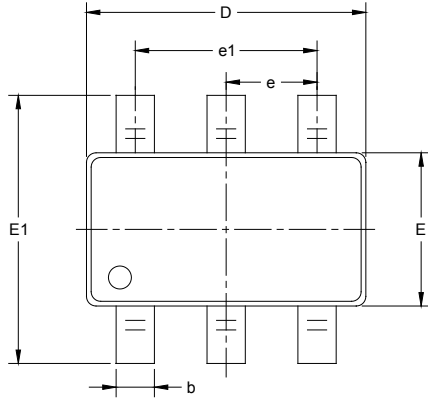

RECOMMENDED LAND PATTERN (Unit: mm)

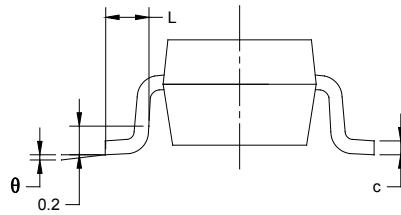
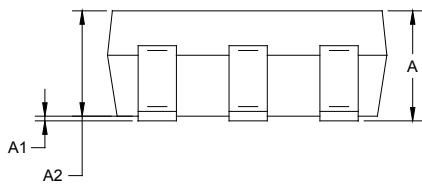

Symbol	Dimensions In Millimeters		Dimensions In Inches	
	MIN	MAX	MIN	MAX
A	1.050	1.250	0.041	0.049
A1	0.000	0.100	0.000	0.004
A2	1.050	1.150	0.041	0.045
b	0.300	0.500	0.012	0.020
c	0.100	0.200	0.004	0.008
D	2.820	3.020	0.111	0.119
E	1.500	1.700	0.059	0.067
E1	2.650	2.950	0.104	0.116
e	0.950 BSC		0.037 BSC	
e1	1.900 BSC		0.075 BSC	
L	0.300	0.600	0.012	0.024
θ	0°	8°	0°	8°

PACKAGE OUTLINE DIMENSIONS

SOIC-8

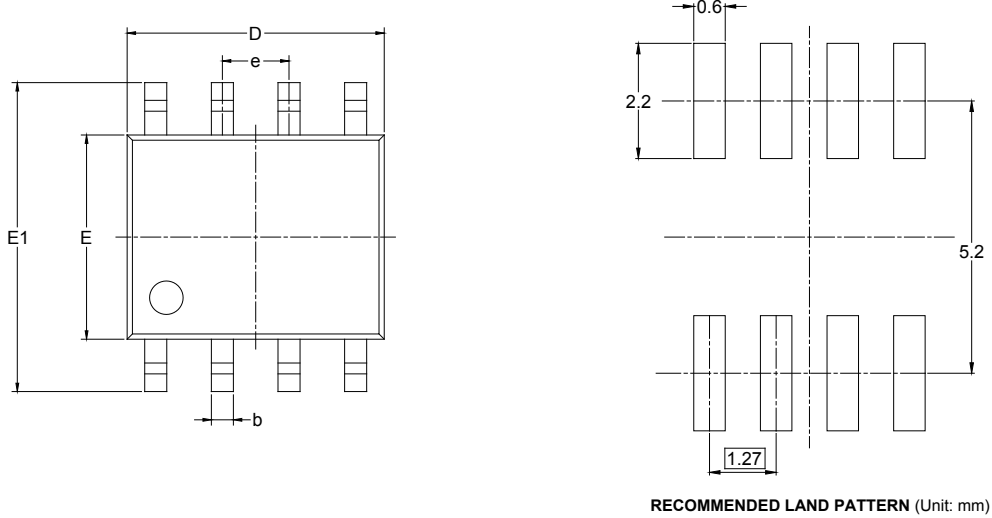

Symbol	Dimensions In Millimeters		Dimensions In Inches	
	MIN	MAX	MIN	MAX
A	1.350	1.750	0.053	0.069
A1	0.100	0.250	0.004	0.010
A2	1.350	1.550	0.053	0.061
b	0.330	0.510	0.013	0.020
c	0.170	0.250	0.006	0.010
D	4.700	5.100	0.185	0.200
E	3.800	4.000	0.150	0.157
E1	5.800	6.200	0.228	0.244
e	1.27 BSC		0.050 BSC	
L	0.400	1.270	0.016	0.050
$\theta$	0°	8°	0°	8°

PACKAGE OUTLINE DIMENSIONS

MSOP-8

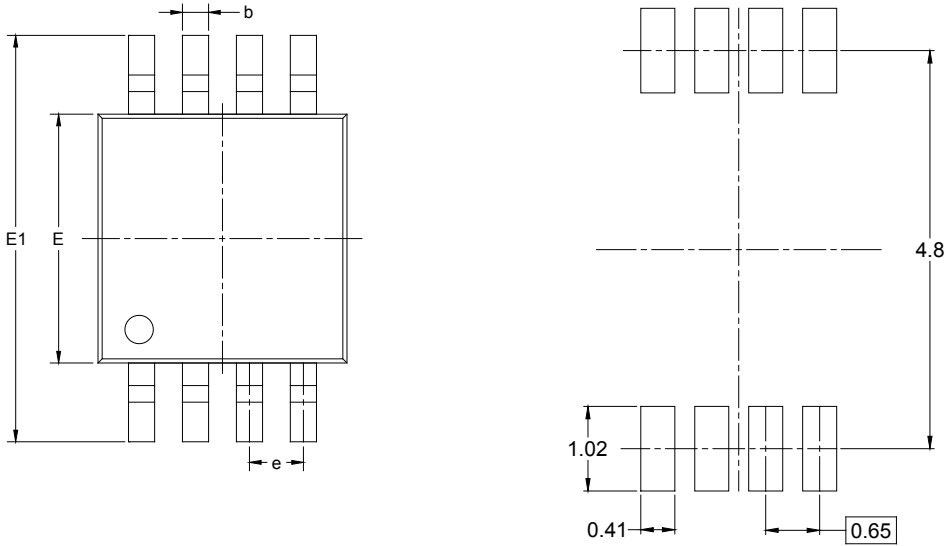

RECOMMENDED LAND PATTERN (Unit: mm)

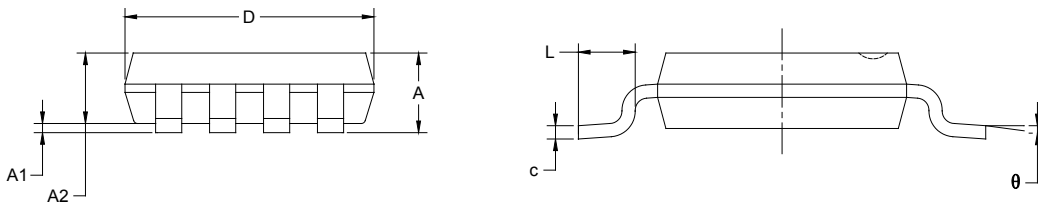

Symbol	Dimensions In Millimeters		Dimensions In Inches	
	MIN	MAX	MIN	MAX
A	0.820	1.100	0.032	0.043
A1	0.020	0.150	0.001	0.006
A2	0.750	0.950	0.030	0.037
b	0.250	0.380	0.010	0.015
c	0.090	0.230	0.004	0.009
D	2.900	3.100	0.114	0.122
E	2.900	3.100	0.114	0.122
E1	4.750	5.050	0.187	0.199
e	0.650 BSC		0.026 BSC	
L	0.400	0.800	0.016	0.031
θ	0°	6°	0°	6°

# PACKAGE INFORMATION

## TAPE AND REEL INFORMATION

### REEL DIMENSIONS



### TAPE DIMENSIONS



NOTE: The picture is only for reference. Please make the object as the standard.

### KEY PARAMETER LIST OF TAPE AND REEL

Package Type	Reel Diameter	Reel Width W1 (mm)	A0 (mm)	B0 (mm)	K0 (mm)	P0 (mm)	P1 (mm)	P2 (mm)	W (mm)	Pin1 Quadrant
SC70-5	7"	9.5	2.25	2.55	1.20	4.0	4.0	2.0	8.0	Q3
SOT-23-5	7"	9.5	3.20	3.20	1.40	4.0	4.0	2.0	8.0	Q3
SOT-23-6	7"	9.5	3.17	3.23	1.37	4.0	4.0	2.0	8.0	Q3
SOIC-8	13"	12.4	6.40	5.40	2.10	4.0	8.0	2.0	12.0	Q1
MSOP-8	13"	12.4	5.20	3.30	1.50	4.0	8.0	2.0	12.0	Q1

D20001



# PACKAGE INFORMATION

## CARTON BOX DIMENSIONS



NOTE: The picture is only for reference. Please make the object as the standard.

## KEY PARAMETER LIST OF CARTON BOX

Reel Type	Length (mm)	Width (mm)	Height (mm)	Pizza/Carton
7" (Option)	368	227	224	8
7"	442	410	224	18
13"	386	280	370	5

DD0002