

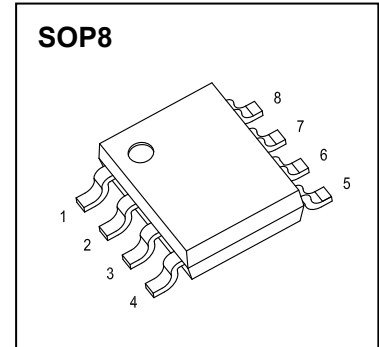

SOP8 Plastic-Encapsulate MOSFETS

CJQ4953 P-Channel Power MOSFET

$V_{(BR)DSS}$	$R_{DS(on)}$ TYP	I_D
-30V	41mΩ@-10V	-5A
	57mΩ@-4.5V	



FEATURE

- Surface Mount Package
- Super High Density Cell Design for Extremely Low $R_{DS(ON)}$

MARKING:

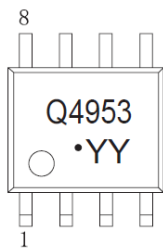

Q4953= Device code
 YY=Code
 Solid dot = Pin1 indicator
 Solid dot=Green molding compound device,
 if none,the normal device.

Equivalent Circuit

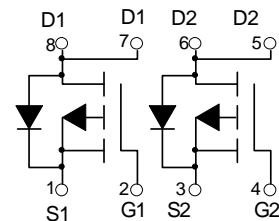

ABSOLUTE MAXIMUM RATINGS ($T_a=25^\circ\text{C}$ unless otherwise noted)

Parameter	Symbol	Value	Unit
Drain-Source Voltage	V_{DS}	-30	V
Gate-Source Voltage	V_{GS}	± 20	V
Continuous Drain Current	I_D ^①	-5	A
Pulsed Drain Current	I_{DM} ^②	-20	A
Single Pulsed Avalanche Energy	E_{AS} ^③	20	mJ
Maximum Power Dissipation	P_D ^④	2.0	W
Thermal Resistance from Junction to Ambient	$R_{\theta JA}$ ^⑤	62.5	$^\circ\text{C/W}$
Operating Junction and Storage Temperature Range	T_J, T_{stg} ^⑥	-55~+150	$^\circ\text{C}$

MOSFET ELECTRICAL CHARACTERISTICS

$T_a=25^\circ\text{C}$ unless otherwise specified

Parameter	Symbol	Test Condition	Min	Typ	Max	Unit
Off characteristics						
Drain-source breakdown voltage	$V_{(BR)DSS}$	$V_{GS} = 0V, I_D = -250\mu A$	-30			V
Zero gate voltage drain current	I_{DSS}	$V_{DS} = -30V,$ $V_{GS} = 0V$	$T_J = 25^\circ\text{C}$		-1	μA
			$T_J = 125^\circ\text{C}$		-200	
Gate-body leakage current	I_{GSS}	$V_{DS} = 0V, V_{GS} = \pm 20V$			± 100	nA
On characteristics ^④						
Gate-threshold voltage	$V_{GS(th)}$	$V_{DS} = V_{GS}, I_D = -250\mu A$	-1.0	-1.4	-2.0	V
Static drain-source on-state resistance	$R_{DS(on)}$	$V_{GS} = -10V, I_D = -4.9A$		41	60	m Ω
		$V_{GS} = -4.5V, I_D = -3.7A$		57	90	m Ω
Dynamic characteristics ^{④ ⑤}						
Input capacitance	C_{iss}	$V_{DS} = -15V, V_{GS} = 0V,$ $f = 1\text{MHz}$		615		μF
Output capacitance	C_{oss}			65		
Reverse transfer capacitance	C_{rss}			57		
Switching characteristics ^{④ ⑤}						
Turn-on delay time	$t_{d(on)}$	$V_{DS} = -15V, V_{GS} = -10V,$ $R_L = 3.6\Omega, R_G = 3\Omega$		8.6		ns
Turn-on rise time	t_r			5.0		
Turn-off delay time	$t_{d(off)}$			28.2		
Turn-off fall time	t_f			13.5		
Drain-Source Diode Characteristics						
Drain-source diode forward voltage	V_{SD} ^④	$V_{GS} = 0V, I_S = -1.7A$			-1.2	V
Continuous drain-source diode forward current	I_S ^①				-5	A
Pulsed drain-source diode forward current	I_{SM} ^②				-20	A

Notes:

- $T_C=25^\circ\text{C}$ Limited only by maximum temperature allowed.
- $P_W \leq 10\mu s$, Duty cycle $\leq 1\%$.
- EAS condition: $V_{DD} = -30V, V_{GS} = -10V, L = 0.5\text{mH}, R_g = 25\Omega$ Starting $T_J = 25^\circ\text{C}$.
- Pulse Test : Pulse Width $\leq 300\mu s$, duty cycle $\leq 2\%$.
- Guaranteed by design, not subject to production.
- The value of $R_{\theta JA}$ is measured with the device mounted on 1 in² FR-4 board with 2oz. Copper, in a still air environment with $T_a = 25^\circ\text{C}, t \leq 10\text{sec}$. For a dual device with one active die.

Typical Characteristics

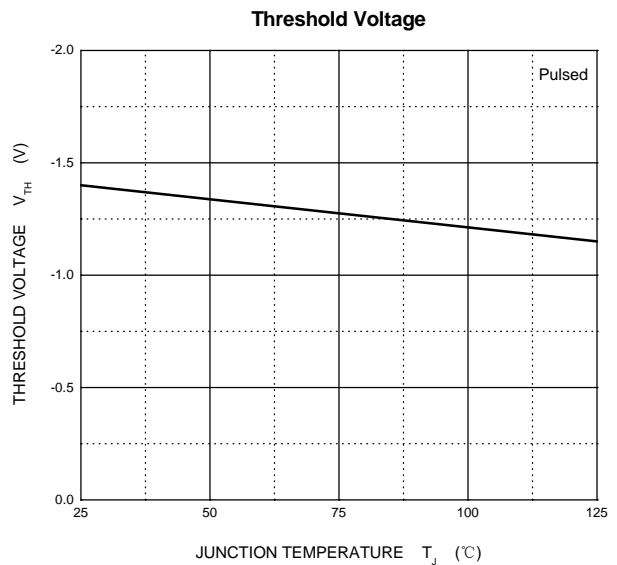
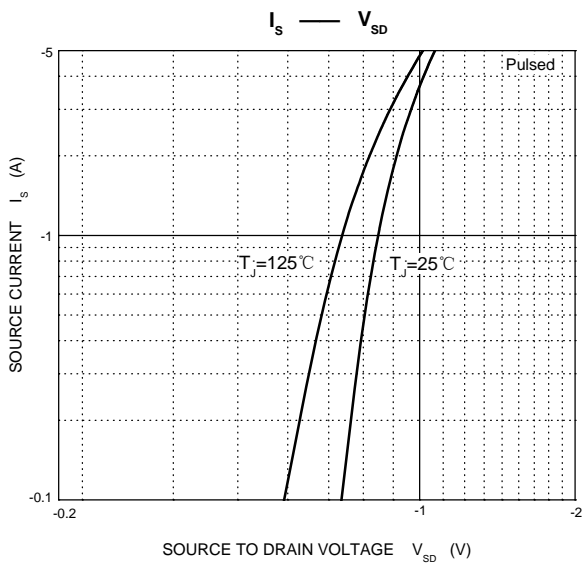
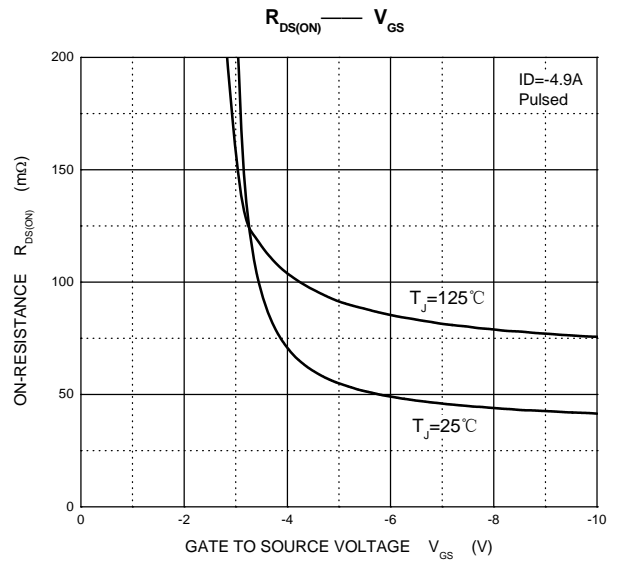
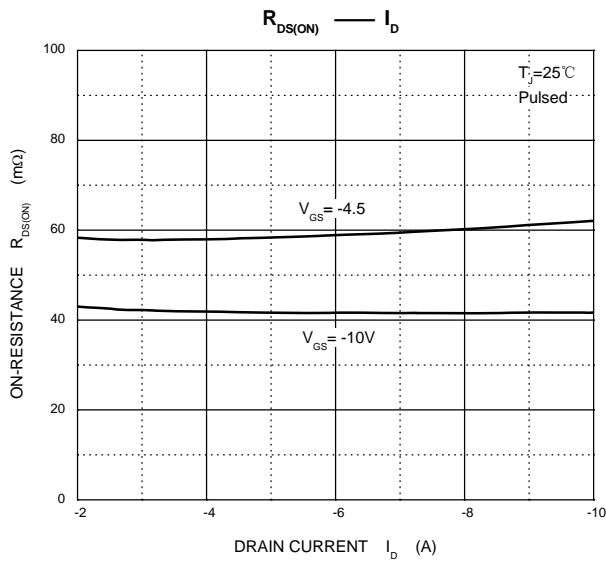
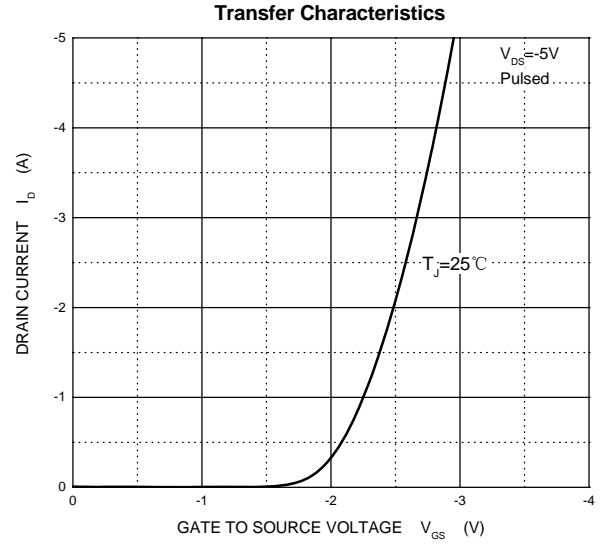
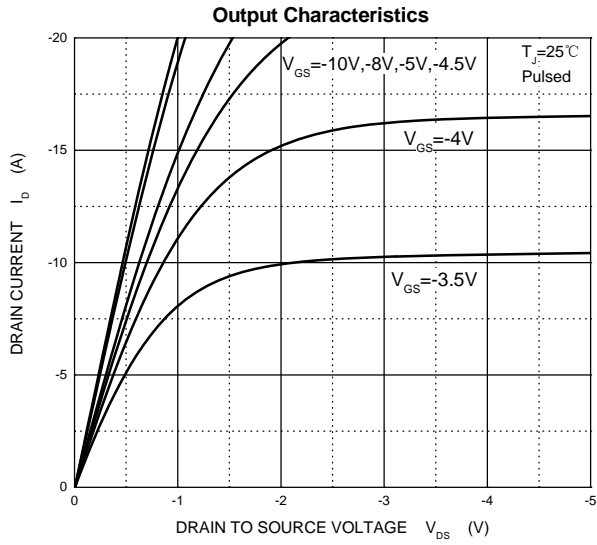

Typical Characteristics

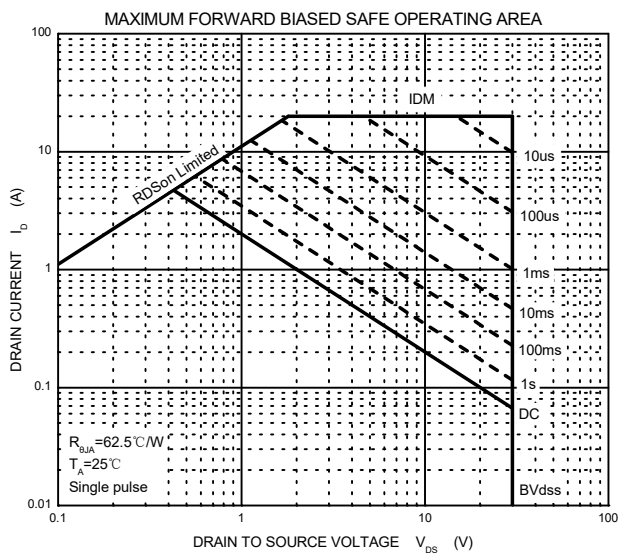
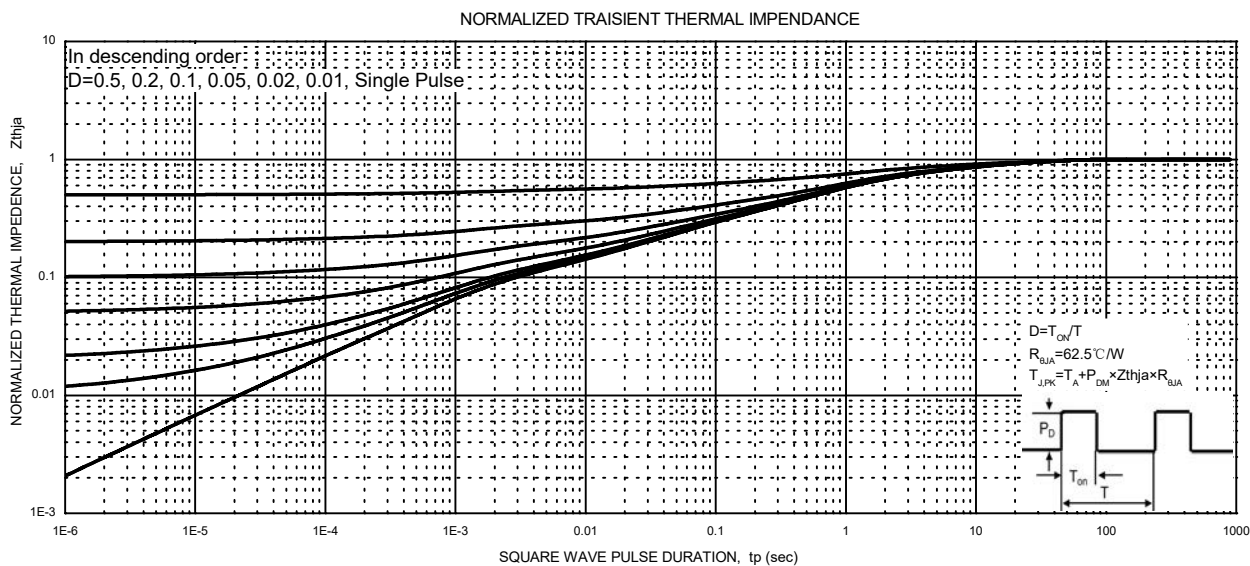

SOP8 Package Outline Dimensions

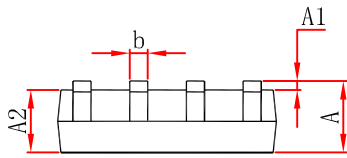
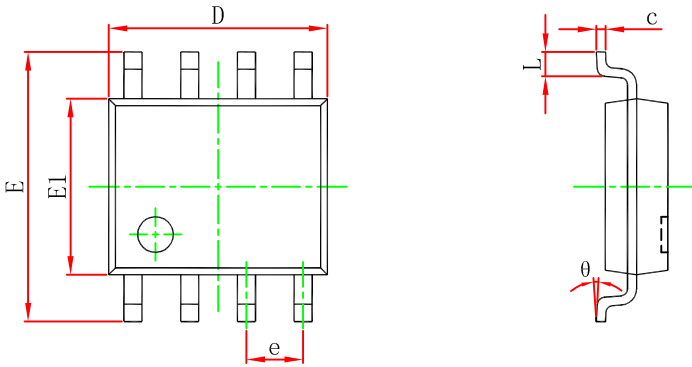

Symbol	Dimensions In Millimeters		Dimensions In Inches	
	Min	Max	Min	Max
A	1.450	1.750	0.053	0.069
A1	0.100	0.250	0.004	0.010
A2	1.350	1.550	0.053	0.061
b	0.330	0.510	0.013	0.020
c	0.170	0.250	0.007	0.010
D	4.700	5.100	0.185	0.201
e	1.270 (BSC)		0.050 (BSC)	
E	5.800	6.200	0.228	0.244
E1	3.800	4.000	0.150	0.157
L	0.400	1.270	0.016	0.050
theta	0°	8°	0°	8°

SOP8 Suggested Pad Layout

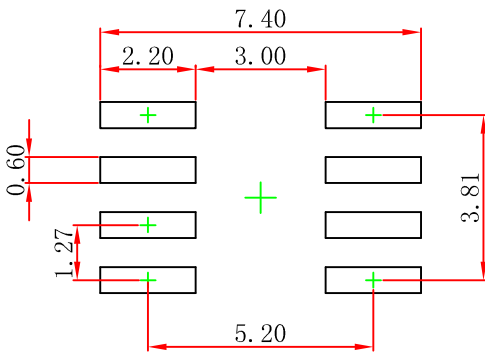

Note:

1. Controlling dimension: in millimeters.
2. General tolerance: $\pm 0.05\text{mm}$.
3. The pad layout is for reference purposes only.

NOTICE

JSCJ reserves the right to make modifications, enhancements, improvements, corrections or other changes without further notice to any product herein. JSCJ does not assume any liability arising out of the application or use of any product described herein.

SOP8 Tape and Reel

SOP8 Embossed Carrier Tape

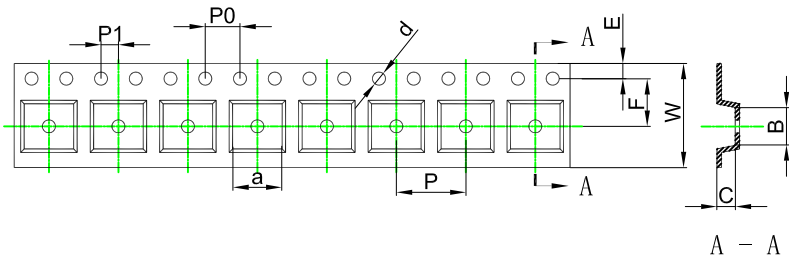

Packaging Description:

SOP8 parts are shipped in tape. The carrier tape is made from a dissipative (carbon filled) polycarbonate resin. The cover tape is a multilayer film (Heat Activated Adhesive in nature) primarily composed of polyester film, adhesive layer, sealant, and anti-static sprayed agent. These reeled parts in standard option are shipped with 2,500 units per 13" or 33cm diameter reel. The reels are clear in color and is made of polystyrene plastic (anti-static coated).

ALL DIM IN mm

Dimensions are in millimeter										
Pkg type	a	B	C	d	E	F	P0	P	P1	W
SOP8	6.40	5.40	2.10	Ø1.50	1.75	5.50	4.00	8.00	2.00	12.00

SOP8 Tape Leader and Trailer

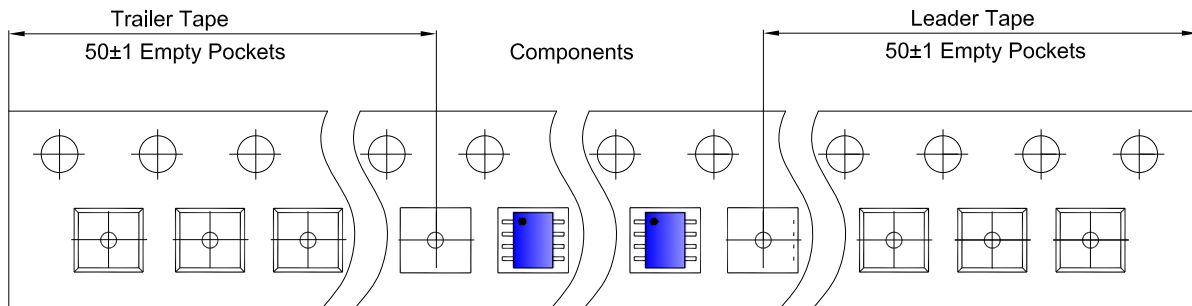

SOP8 Reel

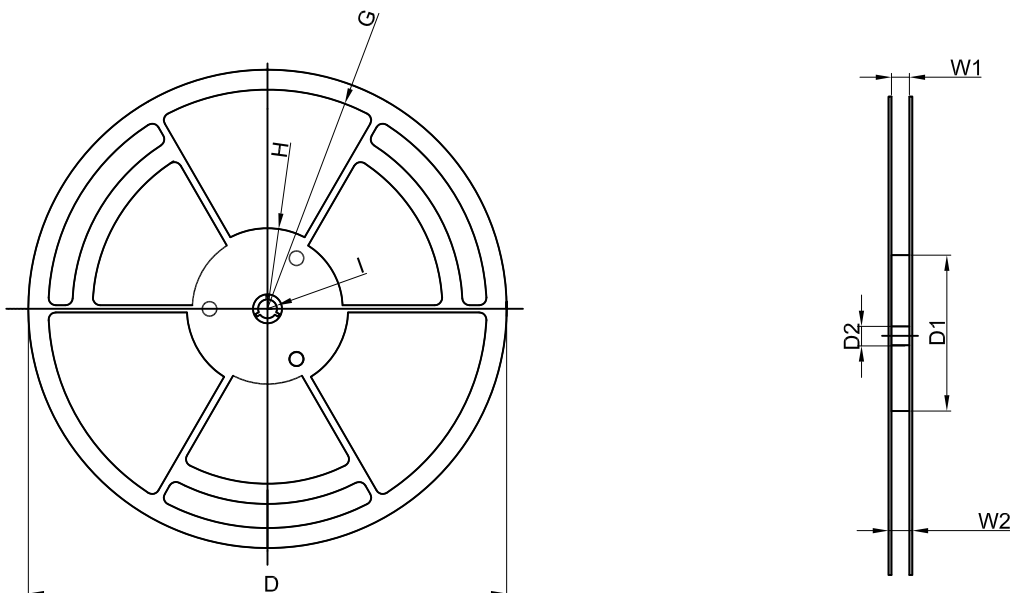

Dimensions are in millimeter								
Reel Option	D	D1	D2	G	H	I	W1	W2
13" Dia	Ø330.00	100.00	13.00	R151.00	R56.00	R6.50	12.40	17.60

REEL	Reel Size	Box	Box Size(mm)	Carton	Carton Size(mm)	G.W.(kg)
4,000 pcs	13 inch	8,000 pcs	360×360×65	64,000 pcs	565×380×390	